



Sprinter

Operating Instructions

Mercedes-Benz



Front passenger airbag warning



▲ WARNING Risk of injury or fatal injuries if the front passenger airbag is enabled

If the front passenger front airbag is enabled, a child on the front passenger seat may be struck by the front passenger airbag during an accident.

NEVER use a rearward-facing child restraint system on a seat with an ENABLED FRONT AIRBAG, DEATH or SERIOUS INJURY to the CHILD can occur.

Observe the chapter "Children in the vehicle".

Welcome to the world of Mercedes-Benz

Before you first drive off, read these Operating Instructions carefully and familiarise yourself with your vehicle. For your own safety and a longer vehicle life, follow the instructions and warning notices in these Operating Instructions. Disregarding them may result in damage to the vehicle or environment or in personal injury.

The equipment or model designation of your vehicle may vary according to:

- model
- order
- national version
- availability

The illustrations in these Operating Instructions show a left-hand drive vehicle. On right-hand-drive vehicles, the layout of components and control elements differs accordingly.

Mercedes-Benz is constantly developing its vehicles further.

Mercedes-Benz therefore reserves the right to introduce changes in the following areas:

- design
- equipment
- technical features

Therefore, the description may differ from your vehicle in some cases.

The following are integral parts of the vehicle:

- Digital Operator's Manual
- printed Operating Instructions
- service booklet
- equipment-dependent supplements

Always keep these documents in the vehicle. If you sell the vehicle, always pass all documents on to the new owner.



Symbols	4	Anti-theft protection	61
At a glance	6	Seats and stowage	64
Cockpit	6	Correct driver's seat position	64
Instrument cluster	8	Seats	64
Overhead control panel	13	Adjusting the steering wheel	76
Door control panel	17	Stowage areas	77
Emergencies and breakdowns	19	Bottle holder	80
Digital Owner's Manual	21	Cup holder	80
Calling up the Digital Operating Instructions	21	Ashtray and cigarette lighter	81
General notes	22	Sockets	81
Environmental protection	22	Wirelessly charging the mobile phone and coupling with the exterior aerial	83
Take-back of end-of-life vehicles	22	Fitting or removing the floor mats	85
Genuine Mercedes-Benz parts	22	Light and vision	86
Information about attachments, add- on equipment, installations and con- versions	23	Exterior lighting	86
Operating Instructions	24	Adjusting the interior lighting	90
Operating safety	24	Changing bulbs	92
Declarations of conformity	25	Windscreen wipers	97
Diagnostics connection	27	Mirrors	99
Notes on changes to the engine output	27	Operating sun visors	100
Qualified specialist workshop	27	Climate control	101
Vehicle registration	28	Overview of climate control systems	101
Correct use of the vehicle	28	Operating climate control systems	103
Information on the REACH regulation	28	Operating air vents	106
Implied warranty	28	Auxiliary heating	107
QR codes for rescue card	28	Operating cargo compartment ventila- tion	113
Data storage	28	Driving and parking	114
Copyright	30	Driving	114
Occupant safety	31	Battery main switch	126
Restraint system	31	Manual transmission	127
Seat belts	32	Automatic transmission	128
Airbags	35	All-wheel drive	131
Children in the vehicle	36	DSR (Downhill Speed Regulation)	134
Notes on pets in the vehicle	44	Electronic level control	135
Opening and closing	45	Refuelling	139
Key	45	Parking	146
Doors	47	Driving and driving safety systems	152
Sliding door	50	Work mode	174
Electrical sliding door	51	Trailer operation	175
Rear-end doors	54	Instrument Display and on-board computer	180
Partition sliding door	55	Overview of instrument display	180
Electrical step	55	Overview of the buttons on the steer- ing wheel	181
Platform dropsides	57	Operating the on-board computer	181
Side window	58		

Overview of the displays on the multi-function display	182	Cleaning and care	286
Setting the instrument lighting	183		
Menus and submenus	183		
LINGUATRONIC	188	Breakdown assistance	291
Notes on operating safety	188	Emergency	291
Operation	188	Mercedes-BenzEmergency call system	292
Using LINGUATRONIC effectively	190	Flat tyre	294
Basic voice commands	191	Battery	294
		Towing or tow-starting	303
		Electrical fuses	308
		Vehicle tool kit	309
		Hydraulic jack	310
Mercedes PRO	199		
Information about Mercedes PRO	199	Wheels and tyres	311
Information about Mercedes PRO connect	199	Information on noise or unusual driving characteristics	311
Calling the Mercedes-Benz Customer Centre using the multimedia system	199	Notes on regularly inspecting wheels and tyres	311
Making a call via the overhead control panel	199	Information on driving with summer tyres	311
Information on the breakdown assistance call via the overhead control panel	200	Information on M+S tyres	311
Information on Mercedes PRO connect accident management	200	Notes on snow chains	312
Giving consent to data transfer for Mercedes PRO connect	200	Tyre pressure	313
Transmitted data during a breakdown assistance call	200	Changing a wheel	332
		Spare wheel	341
MBUX multimedia system	201		
Overview and operation	201	Technical data	347
System settings	213	Information on technical data	347
Vehicle information	219	On-board electronics	347
Navigation	220	Vehicle identification plate, vehicle identification number (VIN) and engine number	348
Telephone	245	Operating fluids and capacities	349
Online and Internet functions	257	Vehicle data	357
Media	263	Trailer hitch	357
Radio	267	Lashing points and carrier systems	357
Sound	269		
Transporting	270	Display messages and warning and indicator lamps	360
Notes on loading guidelines	270	Display messages	360
Load distribution	271	Warning and indicator lamps	382
Securing loads	271		
Carrier systems	273	Index	391
Using the interior roof carrier system	274		
Placing a load on the wheel arch	277		
Maintenance and care	278		
ASSYST PLUS service interval display	278		
Engine compartment	278		

In these Operating Instructions, you will find the following symbols:

 **DANGER** Danger due to not observing the warning notices

Warning notices draw your attention to hazards that may endanger your health or life, or the health or life of others.

► Observe the warning notices.

 **ENVIRONMENTAL NOTE** Environmental damage due to failure to observe environmental notes

Environmental notes include information on environmentally responsible behaviour or environmentally responsible disposal.

► Observe environmental notes.

 **NOTE** Damage to property due to failure to observe notes on material damage

Notes on material damage inform you of risks which may lead to your vehicle being damaged.

► Observe notes on material damage.

 These symbols indicate useful instructions or further information that could be helpful to you.

► Instructions

(→ Further information on a topic page)

Display Display in the multifunction display/media display

 Highest menu level to be selected in the multimedia system

 Corresponding submenus to be selected in the multimedia system

* Indicates a cause

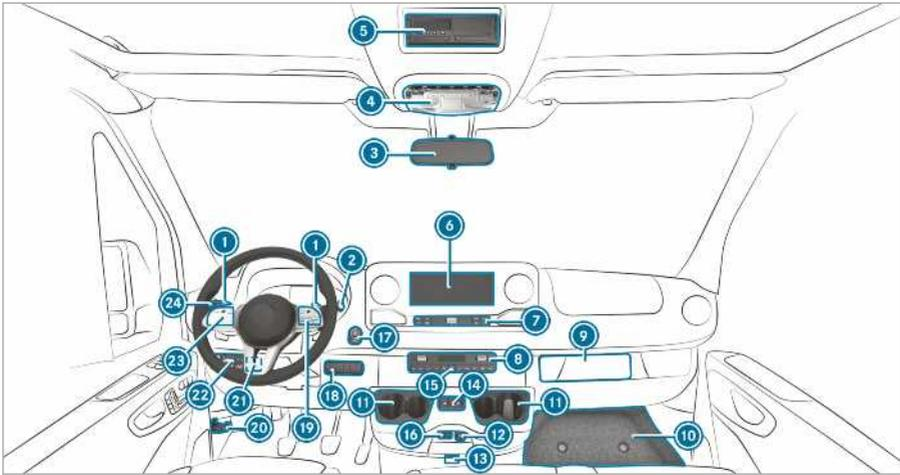

① Steering wheel gearshift paddles	→	130	Activates/deactivates all-wheel drive	→	132
② DIRECT SELECT lever	→	128	Engages/disengages LOW RANGE	→	133
③ Rear-view mirror	→	100	Activates/deactivates DSR	→	134
④ Overhead control panel	→	90	Raises/lowers the vehicle level	→	137
⑤ DIN slot, e.g. for mounting a tachograph or the timer for the stationary heater			Activates/deactivates power take-off	→	174
⑥ MBUX multimedia system display	→	201	Activates/deactivates working speed control (ADR)	→	175
⑦ MBUX multimedia system control elements	→	204	Activates/deactivates cargo compartment ventilation	→	113
⑧ Climate control system	→	101	Activates/deactivates the rotating beacon	→	89
⑨ Tachograph housing			①9 Steering wheel buttons	→	181
⑩ Stowage compartment cover	→	309	②0 Opens the bonnet	→	278
⑪ Cup holder	→	80	②1 Left-hand switch panel		
⑫ 12 V socket	→	81	Sets the working speed (ADR)	→	175
⑬ Vehicles with KEYLESS START: key slot	→	115	②2 Light switch		
⑭ Opens and closes the electric sliding door	→	51	Headlamp range adjuster	→	87
⑮ Switches the hazard warning lights on and off	→	88	②3 Steering wheel buttons	→	181
⑯ USB port	→	78	②4 Combination switch		
⑰ Start/stop button	→	115	Flashing	→	87
⑱ Right-hand switch panel			High beam	→	87

Windscreen wipers	→	97	Rear window wiper	→	97
-------------------	---	----	-------------------	---	----

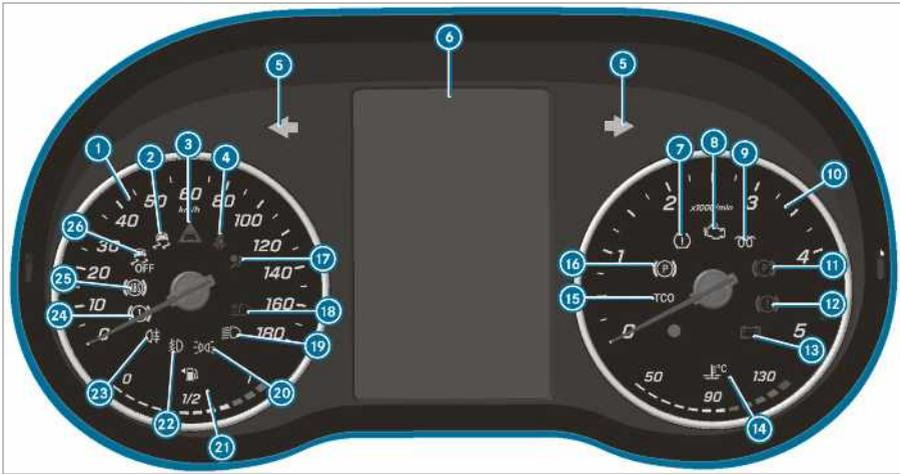

Instrument display (colour display)

①	Speedometer	→	180
②	ESP®	→	382
③	Distance warning	→	387
④	Seat belt not fastened	→	387
⑤	Turn signal lights	→	87
⑥	Multifunction display	→	382
⑦	Tyre pressure loss warning lamp	→	382
⑧	Engine diagnosis	→	388
⑨	Preglow and malfunction in preglow system	→	
⑩	Rev counter	→	180
⑪	Parking brake applied (red)	→	382
⑫	Brakes (red)	→	382
⑬	Electrical fault	→	388
⑭	Coolant temperature indicator and coolant too hot	→	388

⑮ Tachograph (see separate operating manual)

⑮	Tachograph (see separate operating manual)		
⑯	Electric parking brake (yellow)	→	382
⑰	Restraint system	→	31
⑱	High beam	→	87
⑲	Low beam	→	86
⑳	Standing lights	→	86
㉑	Fuel level indicator and fuel reserve with fuel filler cap location indicator	→	388
㉒	Fog light	→	87
㉓	Rear fog light	→	87
㉔	Brakes (yellow)	→	382
㉕	ABS malfunction	→	382
㉖	ESP® deactivated	→	382

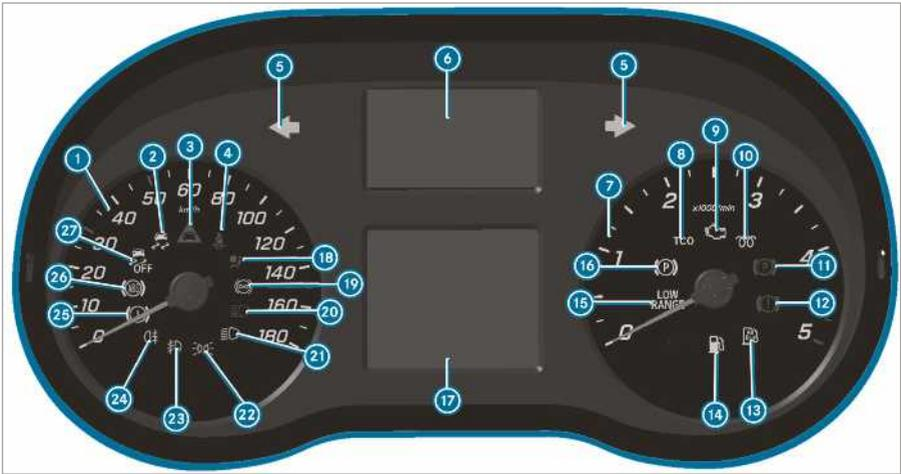

Instrument display (black and white display) with steering wheel buttons

1	Speedometer	→	180
2	ESP®	→	382
3	Distance warning	→	387
4	Seat belt not fastened	→	387
5	Turn signal lights	→	87
6	Display of warning and indicator lamps		
	At least one door is not completely closed		
	Tyre pressure loss	→	382
	Power-assisted steering malfunction	→	387
	Electrical fault	→	388
	SOS emergency call system (Mercedes-Benz emergency call system)		
	Active Brake Assist deactivated		
	ATTENTION ASSIST deactivated		
	Lane Keeping Assist inactive		

	Highbeam Assist	→	89
	(White) Lane Keeping Assist active and ready to issue warnings / (Red) Lane Keeping Assist issues warning		
7	Rev counter		
8	Tachograph (see separate operating manual)		
9	Engine diagnosis	→	388
10	Preglow and malfunction in preglow system		
11	Parking brake applied (red)	→	382
12	Brakes (red)	→	382
13	AdBlue supply low	→	141
14	Reserve fuel	→	388
15	LOW RANGE active	→	133
16	Electric parking brake (yellow)	→	382
17	Multifunction display	→	382
18	Restraint system	→	31
19	Retarder (see separate operating manual)		
20	High beam	→	87
21	Low beam	→	86

	Standing lights	→	86		Brakes (yellow)	→	382
	Fog light	→	87		ABS malfunction	→	382
	Rear fog light	→	87		ESP® deactivated	→	382

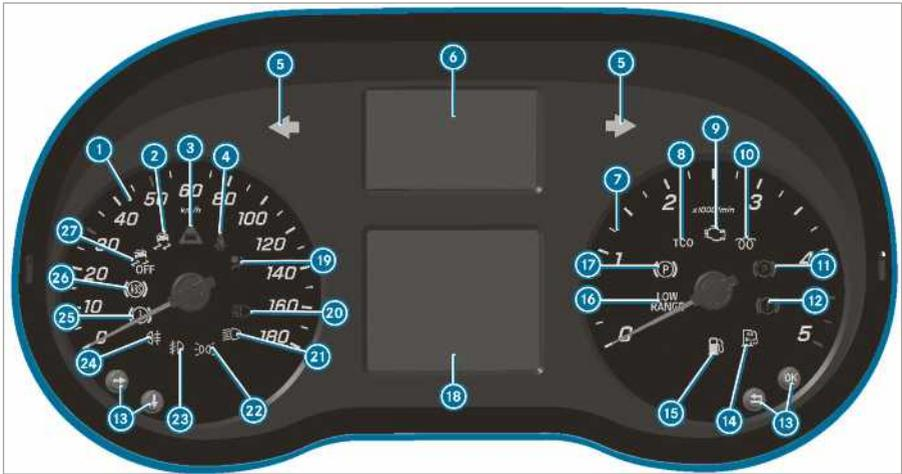

Instrument display (black and white display) without steering wheel buttons

①	Speedometer	→	180
②	ESP®	→	382
③	Distance warning	→	387
④	Seat belt not fastened	→	387
⑤	Turn signal lights	→	87
⑥	Display of warning and indicator lamps		
	At least one door is not completely closed		
	Tyre pressure loss warning lamp	→	382
	Power-assisted steering malfunction	→	387
	Electrical fault	→	388
	SOS emergency call system (Mercedes-Benz emergency call system)		
	Active Brake Assist deactivated		
	ATTENTION ASSIST deactivated		
	Lane Keeping Assist inactive		
	Highbeam Assist	→	89
	(White) Lane Keeping Assist active and ready to issue warnings / (Red) Lane Keeping Assist issues warning		
	Retarder (see separate operating manual)		
⑦	Rev counter		
⑧	Tachograph (see separate operating manual)		
⑨	Engine diagnosis	→	388
⑩	Preglow and malfunction in preglow system		
⑪	Parking brake applied (red)	→	382
⑫	Brakes (red)	→	382
⑬	Buttons to operate the on-board computer	→	181
⑭	AdBlue supply low	→	141
⑮	Reserve fuel	→	388
⑯	LOW RANGE active	→	133
⑰	Electric parking brake (yellow)	→	382
⑱	Multifunction display	→	382
⑲	Restraint system	→	31

20		High beam	→	87	24		Rear fog light	→	87
21		Low beam	→	86	25		Brakes (yellow)	→	382
22		Standing lights	→	86	26		ABS malfunction	→	382
23		Fog light	→	87	27		ESP® deactivated	→	382

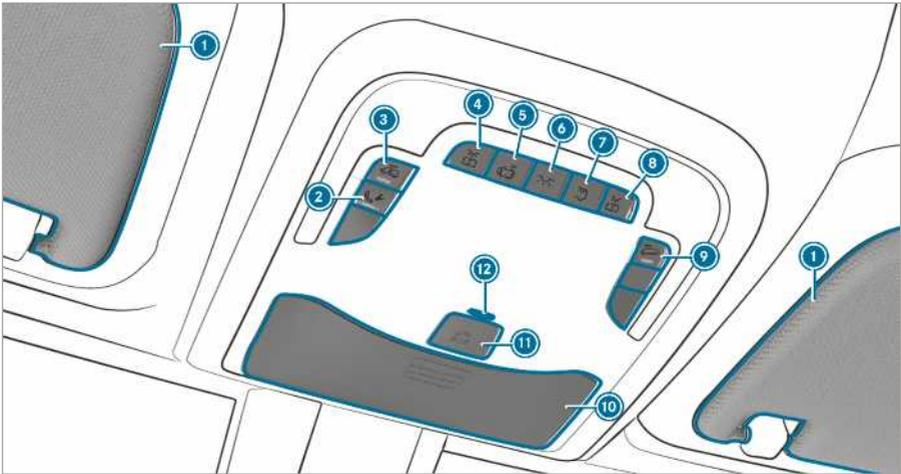

Version 1 of the overhead control panel

① Sun visors	→	100	⑧  Switches the right-hand reading light on/off
② Breakdown assistance call button (Mercedes PRO connect)			⑨  Activates/deactivates tow-away protection → 62
③  Primes/deactivates interior protection	→	62	⑩ Spectacles compartment → 79
Switches the bus interior lighting on/off			⑪  SOS emergency call system (Mercedes-Benz emergency call system)
④  Switches the left-hand reading light on/off			⑫ ATA indicator lamp or emergency call system support battery LED indicator lamp (Russia only)
⑤  Switches the automatic light control on/off			
⑥  Switches the front interior lighting on/off			
⑦  Switches the rear interior lighting on/off			

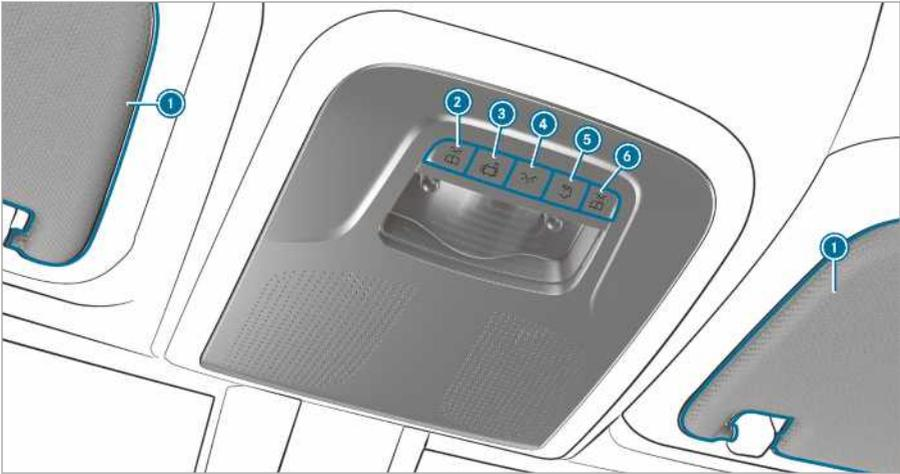

Version 2 of the overhead control panel

- ① Sun visors → 100
- ②  Switches the left-hand reading light on/off
- ③  Switches the automatic light control on/off
- ④  Switches the front interior lighting on/off

- ⑤  Switches the rear interior lighting on/off
- ⑥  Switches the right-hand reading light on/off

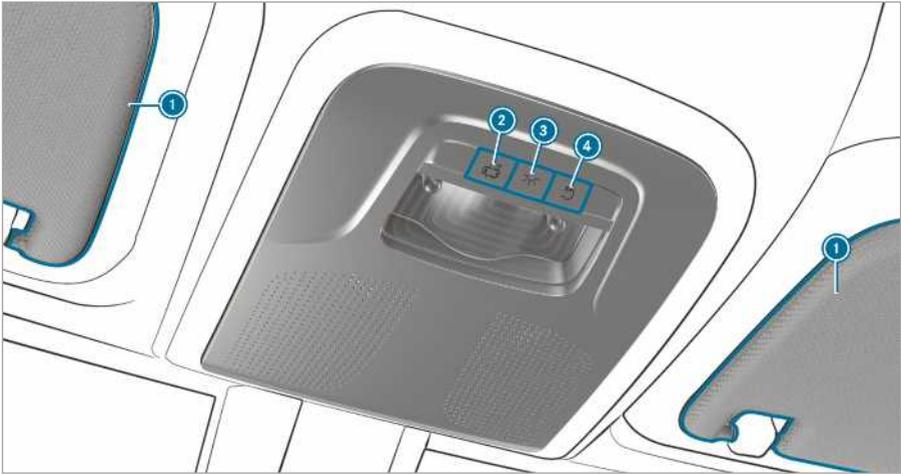

Version 3 of the overhead control panel

- | | |
|--|---|
| <p>① Sun visors → 100</p> <p>②  Switches the automatic light control on/off</p> | <p>③  Switches the front interior lighting on/off → 62</p> <p>④  Switches the rear interior lighting on/off</p> |
|--|---|

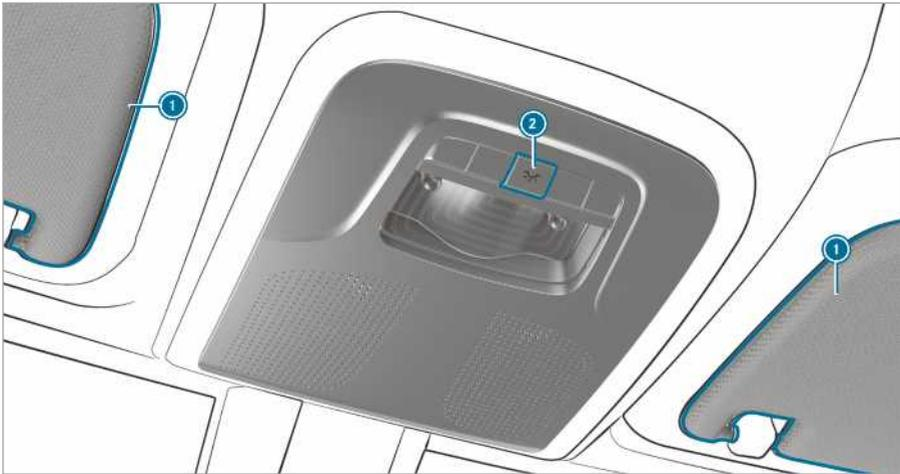

Version 4 of the overhead control panel

- ① Sun visors → 100
 - ② Switches the interior lighting on/off
-

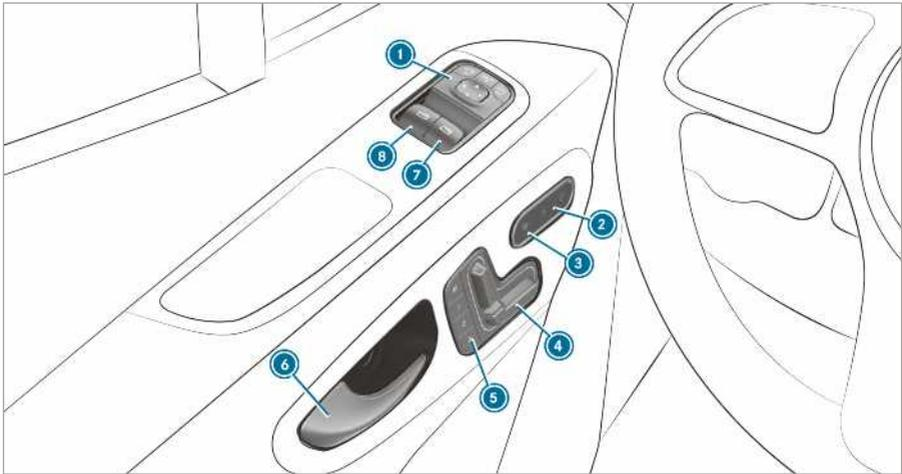

Door control panel in vehicles with electrically adjustable seats

① To adjust the outside mirrors →	99	⑥ To open a door →	48
② To activate/deactivate the central locking system →	49	⑦ To open/close the right-hand side window →	58
③ To switch seat heating on/off →	75	⑧ To open/close the left-hand side window →	58
④ To adjust the front seats electronically →	67		
⑤ To operate the memory function →	69		

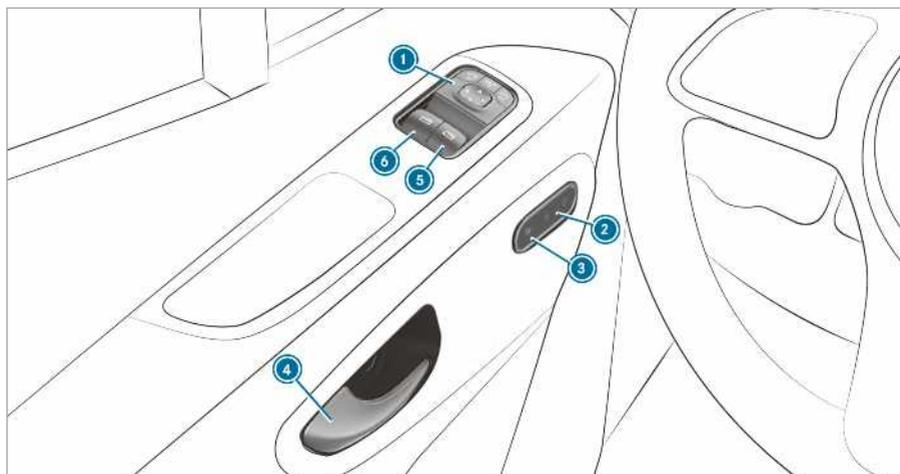

Door control panel vehicles without electrically adjustable seats

① To adjust the outside mirrors →	99	⑤ To open/close the right-hand side window →	58
② To activate/deactivate the central locking system →	49	⑥ To open/close the left-hand side window →	58
③ To switch seat heating on/off →	75		
④ To open a door →	48		

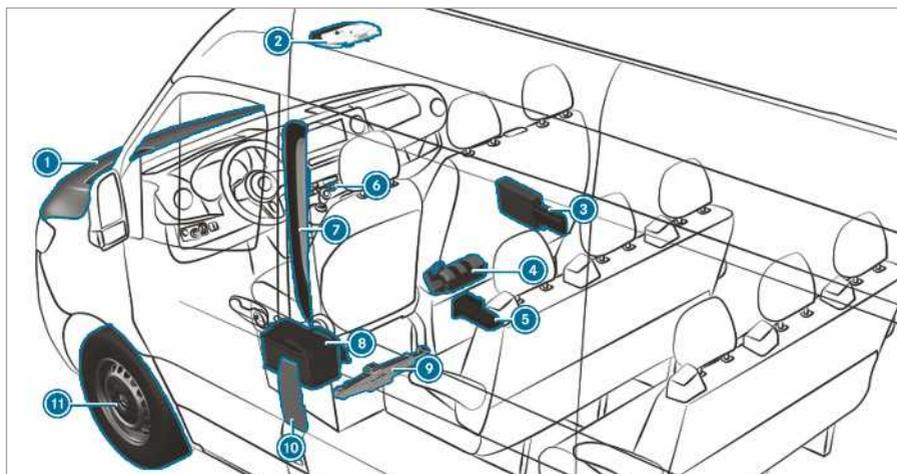

①	Checking and refilling operating fluids	→	349	⑥	Hazard warning lights	→	88
	Starting assistance	→	296	⑦	QR code for accessing the rescue card	→	28
②	Buttons for the SOS emergency call system and breakdown assistance	→	293	⑧	Disconnecting the starter battery	→	298
③	Warning triangle	→	291	⑨	Vehicles with front wheel drive: mechanical jack and tyre-change tool kit	→	334
	Safety vest	→	291	⑩	Fuel filler flap with instruction labels for tyre pressure, fuel type and QR code for accessing the rescue card	→	139
	First-aid kit (soft sided)	→	291	⑪	Flat tyre	→	294
④	Fire extinguisher	→	291				
⑤	Vehicles with rear wheel drive: hydraulic jack and tyre-change tool kit	→	310				

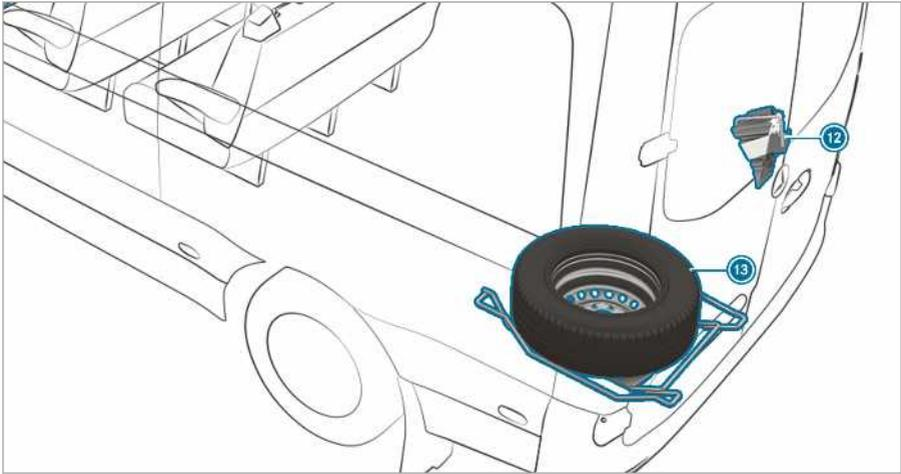

12 Vehicles with rear wheel drive:
chock

13 Spare wheel (example)



341

Calling up the Digital Operating Instructions

Multimedia system:

➤ Info ➤ Owner's Manual ➤ ⓘ



The Digital Operating Instructions describes the function and operation of:

- the vehicle
- the multimedia system

▶ Select one of the following menu items in the Digital Operating Instructions:

- **Search:** here you can use keywords to quickly locate answers to questions concerning vehicle operation.
- **Quick start:** the first steps towards setting up your driver's seat can be found here.
- **Tips:** provides you with information on specific everyday situations for your vehicle.
- **Bookmarks:** you can access your saved personal bookmarks here.
- **Language:** you can set the language for the Digital Operating Instructions here.

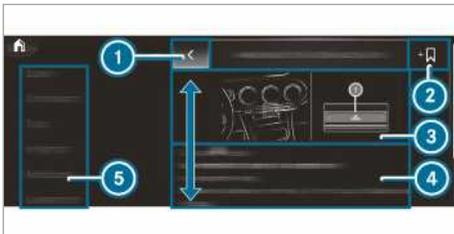

- 1 Back
- 2 Add bookmarks
- 3 Picture
- 4 Content area
- 5 Menu

Some sections of the Digital Operating Instructions, e.g. warnings, can be expanded and collapsed.

Additional options for calling up the Digital Operating Instructions

Deep link: pressing and holding down an entry in the tab bar of the multimedia system opens the corresponding content in the Digital Operating Instructions.



LINGUATRONIC: calling up via the voice control system

The Digital Operating Instructions are deactivated for safety reasons while driving.

- ⓘ The Operating Instructions can also be found in the Mercedes-Benz Guides app in all common app stores.

Environmental protection

 **ENVIRONMENTAL NOTE** Environmental damage due to operating conditions and personal driving style

The pollutant emission of your vehicle is directly related to the way you operate your vehicle.

You can help to protect the environment by operating your vehicle in an environmentally-responsible manner. Please observe the following recommendations on operating conditions and personal driving style.

Operating conditions:

- ▶ make sure that the tyre pressure is correct.
- ▶ do not carry any unnecessary weight (e.g. roof luggage racks once you no longer need them).
- ▶ adhere to the service intervals. a regularly serviced vehicle will contribute to environmental protection.
- ▶ always have maintenance work carried out at a qualified specialist workshop.

Personal driving style:

- ▶ do not depress the accelerator pedal when starting the engine.
- ▶ do not warm up the engine while the vehicle is stationary.
- ▶ drive carefully and maintain a suitable distance from the vehicle in front.
- ▶ avoid frequent, sudden acceleration and braking.
- ▶ change gear in good time and use each gear only up to $\frac{2}{3}$ of its maximum engine speed.
- ▶ switch off the engine in stationary traffic, e.g. by using the ECO start/stop function.
- ▶ drive fuel-efficiently. Observe the ECO display for a fuel-efficient driving style.

Take-back of end-of-life vehicles

EU countries only:

Mercedes-Benz will take back your end-of-life vehicle for environment-friendly disposal in

accordance with the European Union (EU) End-Of-Life Vehicles Directive.

A network of vehicle take-back points and dismantlers has been established for you to return your vehicle. You can leave it at any of these points free of charge. This makes an important contribution to closing the recycling circle and conserving resources.

For further information about the recycling and disposal of end-of-life vehicles, and the take-back conditions, please visit the national Mercedes-Benz website for your country.

Genuine Mercedes-Benz parts

 **ENVIRONMENTAL NOTE** Environmental damage caused by not using recycled/reconditioned components

Daimler AG offers recycled/reconditioned components and parts with the same quality as new parts. The same entitlement from the implied warranty is valid as for new parts.

- ▶ Use recycled/reconditioned components and parts from Daimler AG.

 **NOTE** The effectiveness of the restraint systems can be impaired by installing accessory parts, performing repairs or welding operations

Airbags, seat belt tensioners as well as control units and sensors for the restraint systems can be fitted in the following areas of the vehicle:

- door frames
- roof frames
- doors
- door pillars
- door sills
- seats
- cockpit
- instrument cluster
- centre console

- ▶ Do not install any accessories such as audio systems in these areas.
- ▶ Do not perform repairs or welding operations.

- ▶ Have accessory parts retrofitted at a qualified specialist workshop.

If you use parts, tyres, wheels or safety-relevant accessories which have not been approved by Mercedes-Benz, the operating safety of the vehicle may be jeopardised. Safety-relevant systems, e.g. the brake system, may malfunction. Use only genuine Mercedes-Benz parts or parts of equal quality. Use only tyres, wheels and accessory parts that are approved for your vehicle model.

Mercedes-Benz tests original parts, conversion parts and accessory parts that have been approved for your vehicle model for reliability, safety and suitability. Despite ongoing market research, Mercedes-Benz is unable to assess other parts. Mercedes-Benz accepts no responsibility for the use of such parts in Mercedes-Benz vehicles, even if they have been officially approved or independently approved by a testing centre.

Certain parts are only officially approved for installation or modification if they comply with legal requirements. All genuine Mercedes-Benz parts meet the approval requirements. The use of non-approved parts may invalidate the vehicle's general operating permit.

This is the case in the following situations:

- the vehicle type changes from that stated in the general operating permit.
- other road users could be endangered.
- the emissions or noise levels are adversely affected.

Always specify the vehicle identification number (VIN) when ordering genuine Mercedes-Benz parts (→ page 348).

Information about attachments, add-on equipment, installations and conversions

For safety reasons, have add-on equipment produced and assembled in accordance with the valid Mercedes-Benz add-on equipment guidelines. These add-on equipment guidelines ensure that the chassis and add-on equipment form one unit and that the greatest possible level of operational and driving safety is achieved.

Both vehicle manufacturers as well as body manufacturers must always ensure that the products manufactured by them come into circulation only in a safe state and do not pose any risks to people. Otherwise, there may be consequences

under civil, criminal or public law. All manufacturers are responsible for the products that they have manufactured. The manufacturer of attachments, add-on equipment, inserts and conversions must guarantee compliance with Directive 2001/95/EC on general product safety.

Mercedes-Benz recommends the following for safety reasons:

- Do not make any other changes to the vehicle.
- Obtain approval from Mercedes-Benz in the event of deviations from the approved add-on equipment guidelines.

Acceptance tests performed by public test bodies or official approvals do not rule out safety risks.

Comply with the information about Mercedes-Benz genuine parts (→ page 22).

You will find the Mercedes-Benz add-on equipment guidelines on the internet at https://bb-portal.mercedes-benz.com/portal/kat_iv.html?&L. Remember that special access rights are required in order to access the Mercedes-Benz body manufacturer portal.

You will also find information about the PIN assignment and changing the fuse there.

- ⓘ Further information can be obtained at a qualified specialist workshop.

⚠ WARNING Risk of accident and injury in the event of incorrect conversions or changes to the vehicle

Conversions or changes to the vehicle can impair the function of systems or components.

As a result, they may no longer function as intended and/or endanger the operating safety of the vehicle.

- ▶ Always have conversions or changes to the vehicle made at a qualified workshop.

Even seemingly minor changes to the vehicle, such as attaching a radiator grille in winter, are not permitted. Do not cover the radiator. Do not use any thermal mats, insect protection covers etc.

Otherwise, the values of the vehicle's diagnostic system will be distorted. In some countries, the recording of engine diagnostics data is prescribed by law and must be verifiable and correct at all times.

The factory fits the vehicle with a wooden or plastic load compartment floor; this is an integral part of the vehicle structure. If you have the load compartment floor removed, the vehicle body may be damaged. Load securing will then be impaired and the maximum loading capacity of the tie-down points will no longer be guaranteed. Therefore, do not have the load compartment floor removed.

Notes on the partition

Without a partition, vehicles that are approved as commercial vehicles (N1, N2) do not fulfil ISO 27956, which describes the equipment for properly securing a load in delivery vehicles. If the vehicle is used to transport goods, retrofitting the partition is strongly recommended, as properly securing the load in vehicles without a partition will always be a complex operation.

Operating Instructions

These Operating Instructions describe all models and all standard and special equipment available for your vehicle at the time these Operating Instructions went to press. Country-specific differences are possible. Note that your vehicle may not be fitted with all functions described. This is also the case for systems and functions relevant to safety. Therefore, the equipment on your vehicle may differ from that in the descriptions and illustrations.

The original purchase agreement documentation for your vehicle contains a list of all the systems in your vehicle.

Should you have any questions concerning equipment and operation, consult a Mercedes-Benz Service Centre.

The Owner's Manual and Service Booklet are important documents and should be stored in the vehicle.

Note on vehicles which are equipped by body manufacturers

Always observe the body manufacturer's Operating Instructions. You could otherwise fail to recognise dangers.

Operating safety

⚠ WARNING Risk of accident due to malfunctions or system failures

If you do not have the prescribed service/maintenance work or any required repairs carried out, this could result in malfunctions or system failures.

▶ Always have the prescribed service/maintenance work as well as any required repairs carried out at a qualified specialist workshop.

⚠ WARNING Risk of accident and injury as a result of incorrect modifications to electronic component parts

Modification to electronic components, their software or wiring could impair their function and/or the function of other networked component parts. In particular, systems relevant to safety could also be affected.

As a result, they may no longer function as intended and/or endanger the operating safety of the vehicle.

▶ Never tamper with the wiring and electronic component parts or their software.

▶ You should have all work on electrical and electronic components carried out at a qualified specialist workshop.

If you make any changes to the on-board electronics, the general operating permit is rendered invalid.

Observe the "Vehicle electronics" section in the "Technical data".

⚠ WARNING Risk of fire due to flammable materials on hot parts of the exhaust system

Flammable material such as leaves, grass or twigs may ignite if they come into contact with hot parts of the exhaust system.

▶ When driving on unpaved roads or off-road, regularly check the vehicle underside.

▶ Remove trapped plants or other flammable material, in particular.

▶ If there is damage, consult a qualified specialist workshop immediately.

! NOTE Damage to the vehicle

In the following situations, in particular, there is a risk of damage to the vehicle:

- the vehicle becomes grounded, e.g. on a high kerb or an unpaved road
- the vehicle is driven too fast over an obstacle, e.g. a kerb, speed bump or pot-hole
- a heavy object strikes the underbody or chassis components

In situations such as this, the body, the underbody, chassis components, wheels or tyres could be damaged without the damage being visible. Components damaged in this way can unexpectedly fail or, in the case of an accident, may not absorb the loads that arise as intended.

If the underbody panelling is damaged, flammable materials such as leaves, grass or twigs can collect between the underbody and the underbody panelling. These materials may ignite if they come into contact with hot parts on the exhaust system.

- ▶ Have the vehicle checked and repaired immediately at a qualified specialist workshop.

or

- ▶ If driving safety is impaired while continuing your journey, pull over and stop the vehicle immediately in accordance with the traffic conditions, and contact a qualified specialist workshop.

Declarations of conformity

Electromagnetic compatibility

The electromagnetic compatibility of the vehicle components has been checked and certified according to the currently valid version of Regulation UN-R 10.

Wireless vehicle components

The following information is valid for all wireless components in the vehicle as well as the informa-

tion systems and communication devices integrated in the vehicle:

This vehicle's wireless components meet the basic requirements and other relevant regulations stipulated in Directive 2014/53/EU. Further information is available from any Mercedes-Benz service centre.

Below you will find the addresses of the manufacturers of wireless components. The addresses can not be displayed on the equipment due to its size or nature.

Tyre pressure monitoring sensors

Huf Hülbeck & Fürst GmbH & Co. KG, Steeger Strasse 17, 42551 Velbert, Germany

Remote locking system

Marquardt GmbH, Schlossstrasse 16, 78604 Rieheim, Germany

Huf Hülbeck & Fürst GmbH & Co. KG, Steeger Strasse 17, 42551 Velbert, Germany

Antenna modules

Hirschmann Car Communication GmbH, Stuttgarter Strasse 45-51, 72654 Neckartenzlingen, Germany

Radar sensors

Robert Bosch GmbH, Daimlerstrasse 6, 71229 Leonberg, Germany

Mobile communication and telematics

Yanfeng Visteon Automotive Trim Systems Co., Ltd., 1001 Qinzhou Rd(N), 200233 Shanghai, China

Harman Becker Automotive Systems GmbH, Postfach 2260, 76303 Karlsbad, Germany

Heater booster function remote control

Digades GmbH, Äussere Weberstrasse 20, 02763 Zittau, Germany

Type of wireless applications in the vehicle

Besides the typical frequencies for mobile communications, Mercedes-Benz vehicles use the following wireless applications.

Type of wireless applications in the vehicle

Frequency range	Technology	Transmission output / magnetic field strength
433 MHz (433.05 – 434.79 MHz)	Remote locking system, tyre pressure monitor, antenna modules, heater booster function remote control	≤ 10 mW e.r.p.
2.4 GHz ISM band (2400 – 2483.5 MHz)	Bluetooth®, R-LAN,	≤ 100 mW e.i.r.p.
76 – 77 GHz	76 GHz radar	≤ 55 dBm peak e.i.r.p.

Jack**Hydraulic jack declaration of conformity**

Copy and translation of the original declaration of conformity:

EC declaration of conformity 2006/42/EC

We, WEBER-HYDRAULIK GMBH, Heilbronner Str. 30, 74363 Güglingen, hereby declare that the product "Weber-Hydraulik hydraulic bottle jack", types:

A AD ADX AH AHX AL AT ATD ATDX ATG ATN
ATGX ATPX ATQ AX

Capacity: 2,000 to 100,000 kg

Serial no.: from year of manufacture 01/2010
conforms to the relevant basic health and safety requirements of the EC Machinery Directive.

This EC declaration of conformity becomes invalid:

- in the event of modifications or repairs performed by an unqualified person
- if the products are not used correctly and in accordance with the Operating Instructions
- if the checks to be performed regularly are not carried out

Relevant EU Directives: EC Machinery Directive 2006/42/EC

Applicable standards: ISO 11530

Quality assurance: DIN EN ISO 9001:2000

Güglingen, 01.07.2013

Signed by

Manager, WEBER-HYDRAULIK GmbH

Representative for technical documentation,
WEBER-HYDRAULIK GMBH

Heilbronner Straße 30, 74363 Güglingen

Mechanical jack declaration of conformity

Copy and translation of the original declaration of conformity:

EC declaration of conformity

1.

The signatory, as a representative

Manufacturer:

BRANO a.s.

74741 Hradec nad Moravicí, Opavská 1000,
Czech Republic

ID no.: 64-387-5933

VAT ID no.: CZ64-387-5933

hereby declare under our sole responsibility that the product:

2. a)

Designation:

Jack

Type, number:

A 910 580 00 00

Year of manufacture: 2017

Fulfils all relevant conditions

Directive no. 2006/42/EC

b)

Description and intended use:

The jack is intended only for raising the specified vehicle according to the instructions affixed to the jack.

Technical documentation for the product is held by the manufacturer. Representative for compiling technical documentation: director of the technical department at Brano a.s.

3.

Hradec nad Moravicí

City

4.

12.07.2017

Date

Signed by:

Director of Quality

Diagnostics connection

The diagnostics connection is only intended for the connection of diagnostic devices at a qualified specialist workshop.

⚠ WARNING Risk of accident due to connecting devices to the diagnostics connection

If you connect equipment to a diagnostics connection in the vehicle, it may affect the operation of vehicle systems.

As a result, the operating safety of the vehicle could be affected.

- ▶ Only connect equipment to a diagnostics connection in the vehicle which is approved for your vehicle by Mercedes-Benz.

⚠ WARNING Risk of accident due to objects in the driver's footwell

Objects in the driver's footwell may impede pedal travel or block a depressed pedal.

This jeopardises the operating and road safety of the vehicle.

- ▶ Stow all objects in the vehicle securely so that they cannot get into the driver's footwell.
- ▶ Always fit the floor mats securely and as prescribed in order to ensure that there is always sufficient room for the pedals.
- ▶ Do not use loose floor mats and do not place floor mats on top of one another.

! NOTE Battery discharging from using devices connected to the diagnostics connection

Using devices at the diagnostics connection drains the battery.

- ▶ Check the charge level of the battery.

▶ If the charge level is low, charge the battery, e.g. by driving a considerable distance.

Connecting equipment to the diagnostics connection can lead to emissions monitoring information being reset, for example. This may lead to the vehicle failing to meet the requirements of the next emissions inspection during the main inspection.

Notes on changes to the engine output

Output increases can:

- change the emission values.
- lead to malfunctions.
- result in consequential damage.

The operating safety of the engine is not guaranteed in all situations.

If the vehicle's engine output is increased:

- tyres, suspension, brake system and engine cooling system must be adapted to the increase engine output.
- vehicle must be recertified.
- report changes in output to the accident insurance body.

This will otherwise lead to the invalidation of the vehicle's general operating permit and its insurance coverage.

If you sell the vehicle, inform the buyer of any alterations to the vehicle's engine output. If you do not inform the buyer, this may constitute a punishable offence under national legislation.

Qualified specialist workshop

A qualified specialist workshop has the necessary special skills, tools and qualifications to correctly carry out any necessary work on your vehicle.

This particularly applies to safety-relevant works.

Always have the following work on the vehicle carried out at a qualified specialist workshop:

- safety-relevant works
- service and maintenance work
- repair work
- modifications as well as installations and conversions
- work on electronic component parts

Mercedes-Benz recommends that you use a Mercedes-Benz service centre for this purpose.

Vehicle registration

Mercedes-Benz may ask its service centres to carry out technical inspections on certain vehicles. The quality or safety of the vehicle is improved as a result of the inspection.

Mercedes-Benz can only inform you about vehicle checks if it has your registration data.

In the following cases your vehicle may not be registered to you yet:

- you did not purchase your vehicle at an authorised specialist dealer.
- your vehicle has not yet been inspected at a Mercedes-Benz service centre.

It is advisable to register your vehicle with a Mercedes-Benz service centre.

Inform Mercedes-Benz as soon as possible about any change in address or vehicle ownership. You can do this, for example, at a Mercedes-Benz service centre.

Correct use of the vehicle

If you remove warning stickers, others may fail to recognise the dangers. Leave warning stickers in position.

Observe the following information in particular when operating the vehicle:

- safety notes in these Operating Instructions
- technical data for the vehicle
- traffic rules and regulations
- laws pertaining to motor vehicles and safety standards

Information on the REACH regulation

EU and EFTA countries only:

The REACH Regulation (Regulation (EC) No. 1907/2006, Article 33) stipulates an information obligation for substances of very high concern (SVHC).

Daimler AG is acting to the best of its knowledge to avoid the use and application of these SVHCs and to enable the customer to handle these substances safely. According to supplier information and internal product information of Daimler AG, SVHCs are known which are more than 0.1 per-

cent by weight in individual products of this vehicle.

Further information can be found at:

- <http://www.daimler.com/reach>
- <http://www.daimler.com/reach/en>

Implied warranty

! **NOTE** Damage to the vehicle arising from violation of these operating instructions.

Damage to the vehicle can arise from violation of these operating instructions.

Such damage is not covered by either the Limited Warranty or the new or used-vehicle warranty.

▶ Observe the instructions in these operating instructions on proper operation of your vehicle as well as regarding possible vehicle damage.

QR codes for rescue card

The QR code stickers are affixed to the B-pillar on the driver's and co-driver's side. In the event of an accident, emergency services can use the QR code to quickly determine the corresponding rescue card for your vehicle. The current rescue card contains, in compact form, the most important information about your vehicle e.g. the routing of electric cables.

Further information can be found at <http://www.mercedes-benz.de/qr-code>.

Data storage

Electronic control units

Electronic control units are fitted in your vehicle. Some of these are necessary for the safe operation of your vehicle, while some assist you when driving (driver assistance systems). In addition, your vehicle provides comfort and entertainment functions, which are also made possible by electronic control units.

The electronic control units contain data memories which can temporarily or permanently store technical information about the vehicle's operating state, component loads, maintenance requirements and technical events or faults.

In general, this information documents the state of a component part, a module, a system or the surroundings such as:

- operating states of system components (e.g. fluid levels, battery status, tyre pressure)
- status messages concerning the vehicle and its individual components (e.g. number of wheel revolutions/speed, deceleration, lateral acceleration, display of the fastened seat belts)
- malfunctions or defects in important system components (e.g. lights, brakes)
- information on events leading to vehicle damage
- system reactions in special driving situations (e.g. airbag deployment, intervention of stability control systems)
- ambient conditions (e.g. temperature, rain sensor)

In addition to providing the actual control unit function, this data assists the manufacturer in detecting and rectifying faults and optimising vehicle functions. The majority of this data is temporary and is only processed in the vehicle itself. Only a small portion of the data is stored in the event or fault memory.

When your vehicle is serviced, technical data from the vehicle can be read out by service network employees (e.g. workshops, manufacturers) or third parties (e.g. breakdown services). Services include repair services, maintenance processes, warranty claims and quality assurance measures, for example. The read out is performed via the legally prescribed port for the diagnostics connection in the vehicle. The respective service network locations or third parties collect, process and use this data. They document technical statuses of the vehicle, assist in finding faults and improving quality and are transmitted to the manufacturer, if necessary. Furthermore, the manufacturer is subject to product liability. For this, the manufacturer requires technical data from vehicles.

Fault memories in the vehicle can be reset by a service outlet as part of repair or maintenance work.

Depending on the selected equipment, you can import data into vehicle convenience and infotainment functions yourself.

This includes, for example:

- multimedia data such as music, films or photos for playback in an integrated multimedia system
- address book data for use in connection with an integrated hands-free system or an integrated navigation system
- entered navigation destinations
- data about the use of Internet services

This data can be saved locally in the vehicle or it is located on a device which you have connected to the vehicle (e.g. smartphone, USB flash drive or MP3 player). If this data is stored in the vehicle, you can delete it at any time. This data is sent to third parties only at your request, particularly when you use online services in accordance with the settings that you have selected.

You can store or change convenience settings/individualisations in the vehicle at any time.

Depending on the equipment, this includes, for example:

- seat and steering wheel position settings
- suspension and climate control settings
- individualisations such as interior lighting

If your vehicle is accordingly equipped, you can connect your smartphone or another mobile end device to the vehicle. You can control this by means of the control elements integrated in the vehicle. Images and audio from the smartphone can be output via the multimedia system. Certain information is simultaneously transferred to your smartphone.

Depending on the type of integration, this can include:

- general vehicle data
- position data

This allows you to use selected apps on your smartphone, such as navigation or music playback. There is no further interaction between the smartphone and the vehicle; in particular, vehicle data is not directly accessible. Which type of further data processing occurs is determined by the provider of the specific app used. Which settings you can make, if any, depends on the specific app and the operating system of your smartphone.

Online services

Wireless network connection

If your vehicle has a wireless network connection, data can be exchanged between your vehicle and other systems. The wireless network connection is enabled via the vehicle's transmission and reception unit or via connected mobile end devices (e.g. smartphones). Online functions can be used via this wireless network connection. These include online services and applications/apps, which are provided by the manufacturer or by other providers.

Manufacturer's own services

In the case of the manufacturer's online services, the manufacturer describes the functions in a suitable place (e.g. operating instructions, manufacturer's website) and provides the associated information subject to data protection legislation. Personal identification data may be used to provide online services. The data exchange for this takes place via a secure connection, e.g. with the manufacturer's IT systems intended for the purpose. The collecting, processing, and use of personal identification data beyond the provision of services occurs exclusively on the basis of a legal permit or after due consent.

Generally, you can activate or deactivate the services and functions (partly subject to a fee). In some cases, this also applies to the whole data connection of the vehicle. Excluded from this are special legally prescribed functions and services.

Services of third parties

If it is possible to use online services from other providers, these services are subject to the data protection and terms of use of the responsible provider. The manufacturer has no influence on the contents exchanged whilst using these services.

Please ask the respective service provider for details on the type, extent and purpose of the collection and use of personal data in the context of third party services.

Copyright

Information on licences for free and open-source software used in your vehicle can be found on the data storage medium in your vehicle document wallet and with updates on the following website: <http://www.mercedes-benz.com/opensource>.

Restraint system

Protection by the restraint system

The restraint system includes the following components:

- Seat belt system
- Airbags
- Child restraint system
- Child seat securing systems

The restraint system can help prevent the vehicle occupants from coming into contact with parts of the vehicle interior in the event of an accident. In the event of an accident, the restraint system can also reduce the forces to which the vehicle occupants are subjected.

A seat belt can only provide the best level of protection if it is worn correctly. Depending on the detected accident situation, seat belt tensioners and/or airbags supplement the protection offered by a correctly worn seat belt. Seat belt tensioners and/or airbags are not deployed in every accident.

Vehicles with a front passenger bench seat: the seat belt tensioner on the front passenger seat is triggered whether or not the seat belt tongue is engaged in the seat belt buckle.

If the vehicle does not have a driver's airbag, the seat belt system does not include a seat belt tensioner or a seat belt force limiter.

In order for the restraint system to provide the intended level of protection, each vehicle occupant must observe the following information:

- Fasten seat belts correctly.
- Sit in an almost upright seat position with their back against the seat backrest.
- Sit with their feet resting on the floor, if possible.
- Always secure persons under 1.50 m tall in an additional restraint system suitable for Mercedes-Benz vehicles.

However, no system available today can completely eliminate injuries and fatalities in every accident situation. In particular, the seat belt and airbag generally do not protect against objects penetrating the vehicle from the outside. It is also not possible to completely rule out the risk of injury caused by the airbag deploying.

Limited protection from the restraint system

⚠ WARNING Risk of injury or death from modifications to the restraint system

The restraint system can no longer function correctly after alterations have been made.

The restraint system may then not protect the vehicle occupants as intended by failing in an accident or triggering unexpectedly, for example

- ▶ Never alter the parts of the restraint system.
- ▶ Never tamper with the wiring or any electronic component parts or their software.

If it is necessary to adjust the vehicle to accommodate a person with disabilities, contact a qualified specialist workshop.

Mercedes-Benz recommends that you only use driving aids which have been approved specifically for your vehicle by Mercedes-Benz.

Restraint system functionality

When the ignition is switched on, a self-test is performed, during which the  restraint system warning lamp lights up. It goes out no later than a few seconds after the vehicle is started. The components of the restraint system are then functional.

Malfunctioning restraint system

A malfunction has occurred in the restraint system if:

- the  restraint system warning lamp does not light up when the ignition is switched on
- the  restraint system warning lamp lights up continuously or repeatedly during a journey

⚠ WARNING Risk of injury due to malfunctions in the restraint system

If the restraint system is malfunctioning, restraint system components may be triggered unintentionally or may not deploy as intended during an accident. This may affect the seat belt tensioner or airbag, for example.

- ▶ Have the restraint system checked and repaired immediately at a qualified specialist workshop.

Function of the restraint system in an accident

How the restraint system works is determined by the severity of the impact detected and the type of accident anticipated:

- Frontal impact
- Rear impact
- Side impact

The activation thresholds for the components of the restraint system are determined based on the evaluation of the sensor values measured at various points in the vehicle. This process is pre-emptive in nature. The triggering/deployment of the components of the restraint system must take place in good time at the start of the collision.

Factors which can only be seen and measured after a collision has occurred do not play a decisive role in the deployment of an airbag. Nor do they provide an indication of airbag deployment.

The vehicle may be deformed significantly without an airbag being deployed. This is the case if only parts which are relatively easily deformed are affected and the rate of vehicle deceleration is not high. Conversely, an airbag may be deployed even though the vehicle suffers only minor deformation. If very rigid vehicle parts such as longitudinal members are hit, for example, this may result in sufficiently high levels of vehicle deceleration.

The components of the restraint system can be activated or deployed independently of each other:

Component	Detected deployment situation
Seat belt tensioners	Frontal impact, rear impact, side impact ¹⁾
Driver's airbag, front passenger front airbag	Frontal impact
Side impact airbag	Side impact
Window airbag	Side impact, frontal impact

¹⁾ Only if the vehicle is equipped with a side impact airbag or window airbag.

⚠ WARNING Risk of burns from hot airbag components

The airbag parts are hot after an airbag has been deployed.

- ▶ Do not touch the airbag parts.
- ▶ Have a deployed airbag replaced at a qualified specialist workshop as soon as possible.

Mercedes-Benz recommends that you have the vehicle towed to a qualified specialist workshop after an accident. Take this into account, particularly if a seat belt tensioner is triggered or an airbag deployed.

If the seat belt tensioners are triggered or an airbag is deployed, you will hear a bang, and a small amount of powder may also be released:

- The bang will not generally affect your hearing.
- In general, the powder released is not hazardous to health but may cause short-term breathing difficulties to persons suffering from asthma or other pulmonary conditions. Provided it is safe to do so, leave the vehicle immediately or open the window in order to prevent breathing difficulties.

Seat belts

Protection provided by the seat belt

Always fasten your seat belt correctly before starting a journey. A seat belt can only provide the best level of protection if it is worn correctly.

⚠ WARNING Risk of injury or death due to incorrectly fastened seat belt

If the seat belt is not worn correctly, it cannot perform its intended protective function.

In addition, an incorrectly fastened seat belt can also cause injuries, for example, in the event of an accident or when braking or changing direction suddenly.

- ▶ Always ensure that all vehicle occupants have their seat belts fastened correctly and are sitting properly.

Always observe the instructions about the correct driver's seat position and adjusting the seats (→ page 64).

In order for the correctly worn seat belt to provide the intended level of protection, each vehicle occupant must observe the following information:

- The seat belt must not be twisted and must fit tightly and snugly across the body.
- The seat belt must be routed across the centre of the shoulder and as low down across the hips as possible.
- The shoulder section of the seat belt should not touch your neck nor be routed under your arm or behind your back.
- Avoid wearing bulky clothing, e.g. a winter coat.
- Push the lap belt down as far as possible across your hips and pull tight with the shoulder section of the belt. Never route the lap belt across your abdomen.

Pregnant women must also take particular care with this.

- Never route the seat belt across sharp, pointed, abrasive or fragile objects.
- Only one person may use each seat belt at any one time. Infants and children must never travel sitting on the lap of a vehicle occupant.
- Never secure objects with a seat belt if the seat belt is being used by one of the vehicle's occupants. Always observe the instructions for loading the vehicle when securing objects, luggage or loads (→ page 77).

Also ensure that no objects, e.g. a cushion, are ever placed between a person and the seat.

If children are travelling in the vehicle, be sure to observe the instructions and safety notes on "Children in the vehicle" (→ page 36).

Limitations of the protection provided by the seat belt

▲ WARNING Risk of injury or death due to incorrect seat position

The seat belt does not offer the intended level of protection if you have not moved the seat backrest to an almost vertical position.

When braking or in the event of an accident, you could slide underneath the seat belt and

sustain abdominal or neck injuries, for example.

- ▶ Adjust the seat properly before beginning your journey.
- ▶ Always ensure that the seat backrest is in an almost vertical position and that the shoulder section of your seat belt is routed across the centre of your shoulder.

▲ WARNING Risk of injury or death when additional restraint systems are not used for persons with a smaller build

Persons under 1.50 m tall cannot wear the seat belt correctly without a suitable additional restraint system.

If the seat belt is not worn correctly, it cannot perform its intended protective function. In addition, an incorrectly fastened seat belt can also cause injuries, for example, in the event of an accident or when braking or changing direction suddenly.

- ▶ Always secure persons under 1.50 m tall in a suitable restraint system.

▲ WARNING Risk of injury or death due to damaged or modified seat belts

Seat belts cannot provide protection in the following situations:

- the seat belt is damaged, has been modified, is extremely dirty, bleached or dyed
- the seat belt buckle is damaged or extremely dirty
- modifications have been made to the seat belt tensioner, seat belt anchorage or seat belt retractor

Seat belts may sustain non-visible damage in an accident, e.g. due to glass splinters.

Modified or damaged seat belts could tear or fail in the event of an accident, for example.

Modified belt tensioners may be deployed unintentionally or not function as intended.

- ▶ Never modify the seat belts, seat belt tensioners, seat belt anchorages or seat belt retractors.
- ▶ Make sure that the seat belts are not damaged, are not worn and are clean.

- ▶ Always have the seat belts checked immediately after an accident at a qualified specialist workshop.

Mercedes-Benz recommends that you only use seat belts that have been approved for your vehicle by Mercedes-Benz.

⚠ WARNING Risk of injury or death from deployed pyrotechnic seat belt tensioners

Pyrotechnic seat belt tensioners that have been deployed are no longer operational and are unable to perform their intended protective function.

- ▶ Therefore, have deployed pyrotechnic seat belt tensioners immediately replaced at a qualified specialist workshop.

Mercedes-Benz recommends that you have the vehicle towed to a qualified specialist workshop after an accident.

! NOTE Damage caused by trapping the seat belt

If an unused seat belt is not fully retracted, it may become trapped in the door or in the seat mechanism.

- ▶ Always ensure that an unused seat belt is fully retracted.

Fastening and adjusting seat belts

If the seat belt is pulled quickly or sharply, the seat belt retractor locks. The seat belt strap cannot be pulled out any further.



- ▶ Always engage seat belt tongue ② of the seat belt into seat belt buckle ① of the corresponding seat.
- ▶ Press and hold the seat belt outlet release and slide seat belt outlet ③ into the desired position.
- ▶ Let go of the seat belt outlet release and ensure that seat belt outlet ③ locks into position.

Vehicles with single front passenger seat:

! NOTE Deployment of the seat belt tensioner when the front passenger seat is unoccupied

If the seat belt tongue is engaged in the seat belt buckle of the unoccupied front passenger seat, the seat belt tensioner may also deploy in the event of an accident along with other systems.

- ▶ Only one person should use each seat belt at any one time.

Releasing a seat belt

- ▶ Press the release button in the seat belt buckle and guide the seat belt back with the seat belt tongue.

Function of the seat belt warning system for driver and co-driver

The  seat belt warning lamp in the Instrument Display reminds you that all vehicle occupants must fasten their seat belts correctly.

A warning tone may also sound.

The seat belt warning goes out when the driver's seat belt is fastened. Depending on the vehicle's equipment the seat belt warning may go out as soon as the driver's and co-driver seat belts are fastened.

Only for certain countries: regardless of whether the driver's seat belt is already fastened, the  seat belt warning lamp comes on for six seconds every time after switching on the ignition. After the engine is started, it goes out as soon as the driver's seat belt is fastened.

Airbags

Overview of airbags

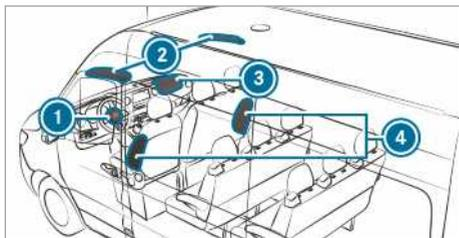

- ① Driver's airbag
- ② Window airbag
- ③ Co-driver front airbag
- ④ Side airbag

An airbag's installation location is identified by the label AIRBAG.

When activated, an airbag can increase protection for the respective vehicle occupant.

Potential protection per airbag:

AIRBAG	Potential protection for ...
Driver's airbag, co-driver front airbag:	Head and chest
Window airbag	Head
Side airbag	Chest and pelvis

Protection by the airbags

Depending on the accident situation, an airbag may supplement the protection offered by a correctly fastened seat belt.

⚠ WARNING Risk of injury or death due to incorrect seat position

If you deviate from the correct seat position, the airbag cannot perform its intended protective function and deployment may even cause further injuries.

In order to avoid risks, each vehicle occupant must always make sure of the following:

- Fasten seat belts correctly. Pregnant women must take particular care to

ensure that the lap belt never lies across the abdomen.

- Adopt the correct seat position and keep as far away as possible from the airbags.
 - Observe the following information.
- ▶ Always make sure that there are no objects between the airbag and vehicle occupant.

To avoid the risks resulting from the deployment of an airbag, each vehicle occupant must observe the following information in particular:

- Before starting your journey, adjust your seat correctly; the driver's seat and front passenger seat should be moved as far back as possible.
- When doing so, always observe the information on the correct driver's seat position (→ page 64).
- Only hold the steering wheel by the steering wheel rim. This allows the airbag to be fully deployed.
 - Always lean against the seat backrest when the vehicle is in motion. Do not lean forwards or against the door or side window. You may otherwise be in the deployment area of the airbags.
 - Always keep your feet on the floor. Do not put your feet on the cockpit, for example. Your feet may otherwise be in the deployment area of the airbag.
 - If children are travelling in the vehicle, observe the additional notes (→ page 36).
 - Always stow and secure objects correctly.

Objects in the vehicle interior may prevent an airbag from functioning correctly. Each vehicle occupant must always make sure of the following in particular:

- There are no people, animals or objects between the vehicle occupants and an airbag.
- There are no objects between the seat, door and door pillar (B-pillar).
- There are no hard objects, e.g. coat hangers, hanging on the grab handles or coat hooks.
- There are no accessory parts, such as mobile navigation devices, mobile phones or cup holders, attached to the vehicle within the deployment area of an airbag, e.g. on the

cockpit, on the door, on the side window or on the side wall trim.

In addition, no connecting cables, tensioning straps or retaining straps must be routed or attached to the vehicle within the deployment area of an airbag. Always comply with the accessory manufacturer's installation instructions and, in particular, the notes on suitable places for installation.

- There are no heavy, sharp-edged or fragile objects in the pockets of your clothing. Store such objects in a suitable place.

Limited protection from airbags

▲ WARNING Risk of injury due to modifications to the airbag cover

If you modify the cover of an airbag or affix objects such as stickers to it, the airbag may no longer function correctly.

- ▶ Never modify the cover of an airbag and do not affix objects to it.

The installation location of an airbag is identified by the AIRBAG symbol (→ page 35).

▲ WARNING Risk of injury or death due to the use of unsuitable seat covers

Unsuitable seat covers can obstruct or prevent the deployment of the airbags integrated into the seats.

Consequently, the airbags cannot protect vehicle occupants as they are designed to do.

- ▶ You should only use seat covers that have been approved for the corresponding seats by Mercedes-Benz.

▲ WARNING Risk of injury due to malfunctions of the sensors in the door panelling

Sensors to control the airbags are located in the doors. Modifications or work not performed correctly to the doors or door panelling, as well as damaged doors, can lead to the function of the sensors being impaired. The airbags might therefore not function properly any more.

Consequently, the airbags cannot protect vehicle occupants as they are designed to do.

- ▶ Never modify the doors or parts of the doors.

- ▶ Always have work on the doors or door panelling carried out at a qualified specialist workshop.

▲ WARNING Risk of injury due to deployed airbag

A deployed airbag no longer offers any protection and cannot provide the intended protective function in the event of an accident.

- ▶ Have the vehicle towed to a qualified specialist workshop in order to have the deployed airbag replaced.

Have deployed airbags replaced immediately.

Children in the vehicle

Notes on the safe transportation of children

▲ WARNING Risk of accident and injury due to children left unattended in the vehicle

If children are left unattended in the vehicle, they could:

- Open doors, thereby endangering other persons or road users.
- Get out and be struck by oncoming traffic.
- Operate vehicle equipment and become trapped, for example.

In addition, the children could also set the vehicle in motion, for example by:

- Releasing the parking brake.
- Changing the transmission position.
- Starting the vehicle.

- ▶ Never leave children unattended in the vehicle.

- ▶ When leaving the vehicle, always take the key with you and lock the vehicle.

- ▶ Keep the vehicle key out of reach of children.

▲ WARNING Risk of fatal injury due to exposure to extreme heat or cold in the vehicle

If people – particularly children – are exposed to extreme temperatures over an extended

period of time, there is a risk of serious or even fatal injury!

- ▶ Never leave anyone – particularly children – unattended in the vehicle.
- ▶ Never leave animals in the vehicle unattended.

⚠ WARNING Risk of burns when the child seat is exposed to direct sunlight

If the child restraint system is exposed to direct sunlight or heat, parts could heat up.

Children could suffer burns on these parts, particularly on metallic parts of the child restraint system.

- ▶ Always make sure that the child restraint system is not exposed to direct sunlight.
- ▶ Protect it with a blanket, for example.
- ▶ If the child restraint system has been exposed to direct sunlight, allow it to cool before securing a child into it.
- ▶ Never leave children unattended in the vehicle.

To improve protection for children younger than 12 years old or under 1.50 m in height, Mercedes-Benz recommends you always observe the following notes:

- Only secure children in a child restraint system which is suitable and recommended for Mercedes-Benz vehicles and which is appropriate for the age, weight and size of the child. Observe the instructions for correct use of the child restraint system.
- If possible, fit the child restraint system on a rear seat.
- Only use the following securing systems for child restraint systems:
 - the seat belt system
 - the ISOFIX securing rings
 - the Top Tether anchorages
- Observe the child restraint system manufacturer's installation instructions.
- Observe the warning labels in the vehicle interior and on the child restraint system.

⚠ WARNING Risk of injury or death caused by incorrect installation of the child restraint system

If the child restraint system is incorrectly installed on a suitable seating position, it cannot perform its intended protective function.

The child cannot be restrained in the event of an accident, heavy braking or a sudden change of direction.

- ▶ Always comply with the manufacturer's installation instructions for the child restraint system and its correct use.
- ▶ Make sure that the entire base of the child restraint system always rests on the sitting surface of the seat.
- ▶ Never place objects under or behind the child restraint system, e.g. cushions.
- ▶ Always use child restraint systems with the original cover designed for them.
- ▶ Always replace damaged covers with genuine covers.

⚠ WARNING Risk of injury or death from unsecured child restraint systems in the vehicle

If the child restraint system is not correctly installed or secured, it could release in the event of an accident, sudden braking or a sudden change in direction.

The child restraint system could be flung around and hit vehicle occupants.

- ▶ Always fit child restraint systems correctly, even when not in use.
- ▶ Always comply with the child restraint system manufacturer's installation instructions.

⚠ WARNING Risk of injury or death caused by the use of damaged child restraint systems

Child restraint systems or their retaining systems that have been subjected to a load in an accident may then not be able to perform their intended protective function.

The child cannot be restrained in the event of an accident, heavy braking or a sudden change of direction.

- ▶ Always replace child restraint systems immediately that have been damaged or involved in an accident.
- ▶ Have the securing systems for the child restraint systems checked at a qualified specialist workshop before installing a child restraint system again.

i Use Mercedes-Benz care products recommended by Mercedes-Benz to clean child restraint systems. Further information can be obtained at a qualified specialist workshop.

The following notes must be observed:

- When fitting a child restraint system to the co-driver seat, observe the information on child restraint systems on the co-driver seat (→ page 40).
- Notes on attaching suitable child restraint systems (→ page 41)
- Notes on the recommended child restraint systems (→ page 43).
- Safety notes on the seat belt (→ page 32).
- Information on the correct use of the seat belt (→ page 34).

Fitting the ISOFIX child restraint system on the rear seat

Notes on ISOFIX child seat securing systems

▲ WARNING Risk of injury or death if the permissible gross mass of the child and child restraint system is exceeded

For ISOFIX child restraint systems in which the child is secured using the integrated seat belt in the child restraint system, the permissible gross mass of the child and child restraint system is 33 kg.

If the child and the child restraint system together weigh more than 33 kg, the ISOFIX child restraint system with integrated seat belt does not offer sufficient protection. An excessive load may be placed on the ISOFIX child seat attachments and the child may not be restrained in the event of an accident, for example.

- ▶ If the child and the child restraint system together weigh more than 33 kg, use only an ISOFIX child restraint system that secures the child with the vehicle seat belt.

- ▶ Also secure the child restraint system with the Top Tether belt, if available.

Always comply with the information about the mass of the child restraint system:

- in the manufacturer's installation and operating instructions for the child restraint system used
- on a label on the child restraint system, if available

Check regularly that the permissible gross mass of the child plus the child restraint system is not exceeded.

When fitting a child restraint system, be sure to observe the manufacturer's installation and operating instructions as well as the correct use of the child restraint system and the suitability of the seats.

ISOFIX is a standardised securing system for special restraint systems. ISOFIX child restraint systems are approved in accordance with UN-R44.

Only child restraint systems that have been approved in accordance with UN-R44 may be attached to ISOFIX mounting brackets.



Symbol for fitting an ISOFIX child restraint system

Fitting ISOFIX child seat securing systems

▲ WARNING Risk of injury or death if the permissible gross mass of the child and child restraint system is exceeded

For ISOFIX child restraint systems in which the child is secured using the integrated seat belt in the child restraint system, the permis-

sible gross mass of the child and child restraint system is 33 kg.

If the child and the child restraint system together weigh more than 33 kg, the ISOFIX child restraint system with integrated seat belt does not offer sufficient protection. An excessive load may be placed on the ISOFIX child seat attachments and the child may not be restrained in the event of an accident, for example.

- ▶ If the child and the child restraint system together weigh more than 33 kg, use only an ISOFIX child restraint system that secures the child with the vehicle seat belt.
- ▶ Also secure the child restraint system with the Top Tether belt, if available.

Always comply with the information about the mass of the child restraint system:

- in the manufacturer's installation and operating instructions for the child restraint system used
- on a label on the child restraint system, if available

Check regularly that the permissible gross mass of the child plus the child restraint system is not exceeded.

When fitting a child restraint system, be sure to observe the manufacturer's installation and operating instructions and the correct use of the child restraint system as well as consider the suitability of the seats.

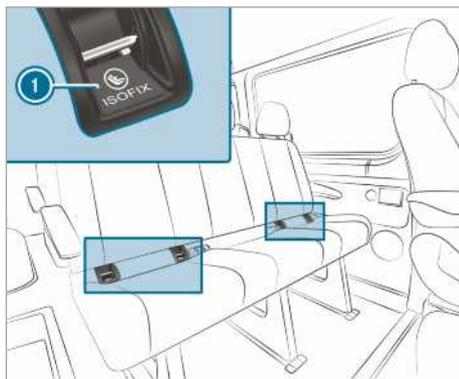

① ISOFIX mounting brackets

Before every trip, make sure that the ISOFIX child restraint system is engaged correctly in both ISOFIX mounting brackets in the vehicle.

! **NOTE** Be careful not to damage the seat belt for the centre seat when fitting the child restraint system

- ▶ Make sure that the seat belt is not trapped.

- ▶ Install the ISOFIX child restraint system on both of the vehicle's mounting brackets.

Securing Top Tether

! **WARNING** Risk of injury due to incorrect attachment of the Top Tether belt

If you attach the Top Tether belt incorrectly, e.g. on an eyelet in the load compartment, the child restraint system will not have been secured correctly.

In an accident, it will therefore be unable to provide the intended level of protection.

- ▶ Only ever attach the Top Tether hook to the designated Top Tether anchorage.

The risk of injury can be reduced by Top Tether. The Top Tether belt facilitates an additional connection between the child restraint system attached with ISOFIX and the vehicle.

The child restraint system must be equipped with a Top Tether belt.

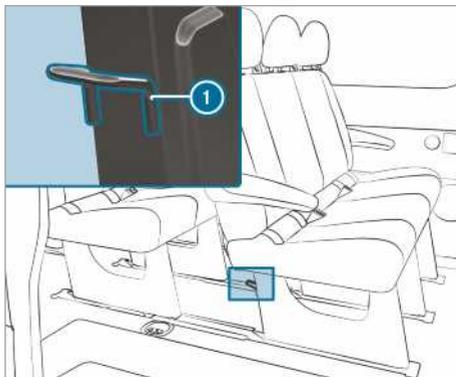

The Top Tether anchorages ① are located on the back of the rear bench seat on the bench seat legs.

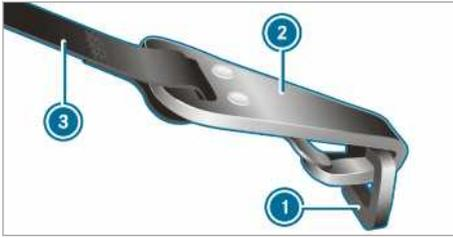

- ▶ If necessary, move the head restraint upwards (→ page 75).
- ▶ Fit the ISOFIX child restraint system with Top Tether. Comply with the child restraint system manufacturer's installation instructions when doing so.
- ▶ Route the Top Tether belt ③ under the head restraint between the two head restraint bars.
- ▶ Hook the Top Tether hook ② into the Top Tether anchorage ① without twisting.
- ▶ Tension the Top Tether belt ③. Comply with the child restraint system manufacturer's installation instructions when doing so.
- ▶ If necessary, slide the head restraint downwards (→ page 75). Make sure that you do not interfere with the correct routing of the Top Tether belt ③.

Child restraint systems on the co-driver seat

Notes on a child restraint system on the co-driver seat

Accident statistics show that children secured on the rear seats are safer than children secured on the front seats. For this reason, Mercedes-Benz strongly advises that you fit a child restraint system to a rear seat.



Warning notice on the co-driver sun visor

NEVER use a rearward facing child restraint on a seat protected by an ACTIVE AIRBAG in front of it, DEATH or SERIOUS INJURY to the CHILD may occur.

Always observe the information on the safe transportation of children (→ page 36).

Notes on rearward-facing child restraint systems



The sticker is visible when the co-driver door is open:

The co-driver front airbag cannot be disabled. This is indicated by a special sticker on the co-driver side of the cockpit. Always fit a rearward-facing child restraint system on a suitable rear seat, but never on the co-driver seat.

Notes on forward-facing child restraint systems on the co-driver seat

When using the child restraint system on the co-driver seat, you must observe the following points:

- Set the co-driver seat to its rearmost position. If on a seat with seat height adjustment, also set the seat to its highest position.
- Set the seat backrest to an almost vertical position.
- Retract the seat cushion length completely.
- The base of the child restraint system must lie fully on the co-driver seat cushion.
- The backrest of a forward-facing child restraint system must, as far as possible, lie flat against the backrest of the co-driver seat. The child restraint system must not touch the roof or be put under strain by the head restraints.
- If necessary, adjust the angle of the seat backrest and the position of the head restraints accordingly.
- Set the seat cushion angle in such a way that the front edge of the seat cushion is in the highest position and the rear edge of the seat cushion is in the lowest position.
- Always make sure that the shoulder belt strap is correctly routed from the seat belt outlet of

the vehicle to the shoulder belt guide on the child restraint system. The shoulder belt strap must be routed forwards and downwards from the seat belt outlet.

- If necessary, adjust the seat belt outlet and the co-driver seat as appropriate.
- Never place objects under or behind the child restraint system, e.g. cushions.

Always observe the manufacturer's installation and operating instructions for the child restraint system being used, and the information on fitting suitable child restraint systems (→ page 41).

Suitability of the seats for child restraint systems

Notes on attaching suitable child restraint systems

Only child restraint systems that meet the UNECE standard UN-R44 are permitted for use in the vehicle.

Example of an approval label on child restraint systems:

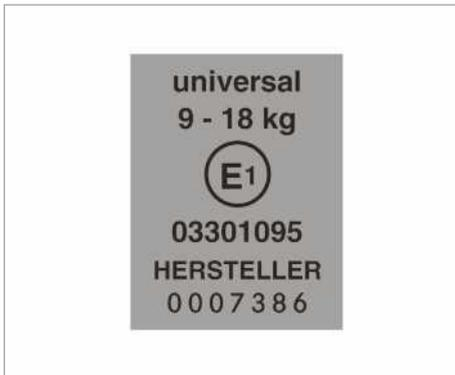

Label for child restraint systems in accordance with UN-R44

ISOFIX child restraint systems of the following "Universal" category can be used in accordance with the tables on suitability of seats for the attachment of child restraint systems on seats labelled U, UF or IUF.

Semi-universal child restraint systems are indicated by the text "semi-universal" on the approval

label. They can only be used if the vehicle and the seat are listed in the child restraint system manufacturer's vehicle model list.

Notes on the suitability of seats for attaching belt-secured child restraint systems

Observe the following information:

- **When using a baby car seat of the category 0/0+ and a rearward-facing child restraint system on a rear seat:** adjust the driver's and front passenger seat such that the seat does not touch the child restraint system.
- **When using a forward-facing child restraint system of category I:** the backrest of the child restraint system must, as far as possible, rest flat against the backrest of the seat.
- For certain child restraint systems in weight category II or III, there may be restrictions in the maximum size setting, e.g. due to possible contact with the roof.
- Make sure that the child's feet do not touch the front seat. If necessary, move the front seat forward slightly.
- The child restraint system must not touch the roof or be put under strain by the head restraints. Adjust the head restraints accordingly.
- Observe the manufacturer's installation instructions for the child restraint system.

Legend for the table:

- X Not suitable for children in this weight category.
- U Suitable for child restraint systems of the "Universal" category in this weight category.
- UF Suitable for forward-facing child restraint systems of the "Universal" category in this weight category.
- L Suitable for semi-universal child restraint systems according to the table in "Recommended child restraint systems", or if the vehicle and the seat are listed in the child restraint system manufacturer's vehicle model list.

Front passenger seat

Weight category	Front passenger seat (with front passenger front airbag) ¹	Front passenger seat (without front passenger front airbag) ¹	Single seat
Category 0: up to 10 kg	X	U	X
Category 0+: up to 13 kg	X	U	X
Category I: 9 to 18 kg	UF	U	X
Category II: 15 to 25 kg	UF	U	X
Category III: 22 to 36 kg	UF	U	X

¹ Move the front passenger seat to its rearmost and highest position.

Front passenger bench seat

Weight category	Outer seat (with front passenger front airbag)	Outer seat (without front passenger front airbag)	Centre
Category 0: up to 10 kg	X	U	X
Category 0+: up to 13 kg	X	U	X
Category I: 9 to 18 kg	UF	U	X
Category II: 15 to 25 kg	UF	U	X
Category III: 22 to 36 kg	UF	U	X

Rear bench seat

Weight category	Rear bench seat (crewcab)	Rear bench seat (Standard/Comfort)
Category 0: up to 10 kg	U	U
Category 0+: up to 13 kg	U	U
Category I: 9 to 18 kg	U	U
Category II: 15 to 25 kg	U	U
Category III: 22 to 36 kg	U	U

Notes on recommended child restraint systems

Recommended child restraint systems for attaching with the vehicle seat belt

Weight categories	Manufacturer	Type	Approval number (E1 ...)	Order number (A 000 ...) with colour code 9H95
Category 0: up to 10 kg up to approximately 6 months	Britax Römer	BABY SAFE plus II	04 301 146	970 13 02
Category 0+: up to 13 kg up to approximately 15 months	Britax Römer	BABY SAFE plus II	04 301 146	970 13 02
Category I: 9 to 18 kg between approximately 9 months and 4 years	Britax Römer	DUO plus	04 301 133	970 17 02
Category II/III: 15 to 36 kg between approximately 4 and 12 years	Britax Römer	KIDFIX	04 301 198	970 20 02
	Britax Römer	KIDFIX XP	04 301 304	970 23 02

-  You can obtain further information on the correct child restraint system at any Mercedes-Benz Service Centre.

Activating/deactivating child safety locks for the doors

 **WARNING** Risk of accident and injury due to children left unattended in the vehicle

If children are left unattended in the vehicle, they could:

- Open doors, thereby endangering other persons or road users.
- Get out and be struck by oncoming traffic.
- Operate vehicle equipment and become trapped, for example.

In addition, the children could also set the vehicle in motion, for example by:

- Releasing the parking brake.

- Changing the transmission position.
- Starting the vehicle.

- ▶ Never leave children unattended in the vehicle.
- ▶ When leaving the vehicle, always take the key with you and lock the vehicle.
- ▶ Keep the vehicle key out of reach of children.

 **WARNING** Risk of fatal injury due to exposure to extreme heat or cold in the vehicle

If people – particularly children – are exposed to extreme temperatures over an extended period of time, there is a risk of serious or even fatal injury!

- ▶ Never leave anyone – particularly children – unattended in the vehicle.
- ▶ Never leave animals in the vehicle unattended.

⚠ WARNING Risk of accident and injury due to children left unattended in the vehicle

When children are travelling in the vehicle, they could:

- open doors, thereby endangering other people or road users
 - get out of the vehicle and be hit by traffic
 - operate vehicle equipment and become trapped, for example
- ▶ When children are travelling in the vehicle, always activate the available child safety locks.
- ▶ Never leave children unattended in the vehicle.
- ▶ When leaving the vehicle, always take the key with you and lock the vehicle.

Vehicles for the United Kingdom: observe the important safety notes in the "Notes on the additional door lock" section.

The following doors have child safety locks:

- sliding doors
- rear doors on a crewcab

The child safety locks on the doors secure each door separately. The doors can no longer be opened from the inside (exception: electric sliding door). When the vehicle is unlocked, the door can be opened from the outside.

If the electric sliding door is secured, only the sliding door controls in the rear are deactivated. The electric sliding door can be opened at any time using the switch in the centre console (→ page 51).

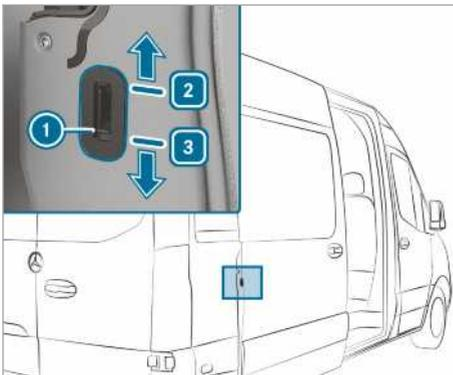

Example: sliding door child safety lock

- ▶ Slide child safety bolt ① to position ② (activate) or ③ (deactivate).
- ▶ Make sure that the child safety locks are working properly.

Notes on pets in the vehicle

⚠ WARNING Risk of accident and injury due to animals left unsecured or unattended in the vehicle

If you leave animals in the vehicle unattended or unsecured, they could possibly press down buttons or switches.

Thereby an animal may:

- activate vehicle equipment and become trapped, for example
- switch systems on or off and endanger other road users

Unsecured animals may be thrown around in the vehicle in the event of an accident or sudden steering and braking manoeuvres and injure vehicle occupants in the process.

- ▶ Never leave animals in the vehicle unattended.
- ▶ Always correctly secure animals while driving, e.g. using a suitable animal carrier.

Key**Notes on radio connections of the key**

- ⚠ DANGER** Risk of fatal injury to persons with medical devices from the electromagnetic radiation of the start/stop button

Persons with medical devices, e.g. pacemakers or defibrillators:

When you operate the start/stop button, a radio connection is established between the key and the vehicle.

The electromagnetic radiation can affect the functionality of a medical device.

- ▶ Before operating the vehicle, consult your doctor or the manufacturer of the medical device about any possible effects of emissions from such systems.

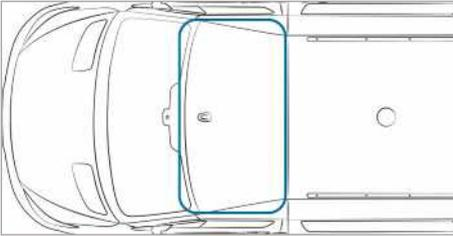
Detection range of aerial of KEYLESS-START function**Overview of key functions**

- ⚠ WARNING** Risk of accident and injury due to children left unattended in the vehicle

If children are left unattended in the vehicle, they could:

- open doors, thereby endangering other persons or road users.
- get out of the vehicle and be hit by oncoming traffic.
- operate vehicle equipment and become trapped, for example.

In addition, children could also set the vehicle in motion, for example, by:

- releasing the parking brake.

- shifting the automatic transmission out of park position **P** or shifting manual transmission into neutral.
- starting the engine.

- ▶ When leaving the vehicle, always take the key with you and lock the vehicle.
- ▶ Never leave children and animals unattended in the vehicle.
- ▶ Keep the vehicle key out of reach of children.

- ⚠ NOTE** Damage to the key caused by magnetic fields

- ▶ Keep the key away from strong magnetic fields.

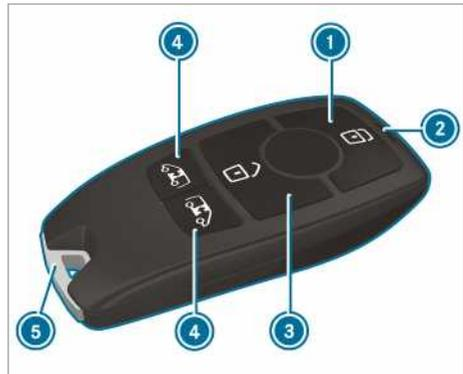

- ① To lock
- ② Battery check lamp
- ③ To unlock
- ④ To unlock load compartment (sliding doors and rear doors)/to unlock and open/close electric sliding doors
- ⑤ Emergency key element

The key's factory setting enables you to centrally lock and unlock the following components:

- the driver's door and the co-driver door
- the sliding doors
- the rear doors

- i** If you do not open the vehicle within approximately 40 seconds of unlocking, the vehicle will lock again and anti-theft protection will be primed again.

Do not keep the key together with electronic devices or metallic objects. This can affect the key's functionality.

- ① If the battery check lamp does not light up when you press the  or  button, the battery is discharged.

Replace the key battery (→ page 46).

Activating/deactivating the acoustic locking verification signal

Multimedia system:

→  » Settings » Vehicle

▶ Switch **Acoustic lock** on or off.

① Please note:

The selected setting for the acoustic locking verification signal must comply with the relevant national road and traffic regulations. In some countries, including Germany, using the acoustic locking verification signal is forbidden by traffic laws (in accordance with § 16 Para. 1 and § 30 Para. 1 of the German national road traffic regulations). The driver of the vehicle must comply with these regulations. In countries where the use of this function is forbidden, this function is not activated in the vehicle and must not be activated.

Changing the unlocking settings

The key has the following adjustable unlocking functions:

- unlock centrally
- unlock driver's and co-driver door (panel van)
- unlock driver's door (crewbus, chassis version)

▶ **To switch between the settings:** press and hold the  and  buttons at the same time for approximately six seconds until the battery indicator lamp flashes twice.

When the locking function is selected for the driver's door or the driver's and co-driver door:

- pressing the  button a second time unlocks the vehicle centrally

Reducing the energy consumption of the key

If you do not use the vehicle or a key for an extended period, you may deactivate the KEYLESS START function of the key.

▶ **To deactivate:** press the  button on the key twice in quick succession.

The battery indicator lamp on the key lights up twice quickly and once for longer.

▶ **To activate:** press any button on the key.

When starting the vehicle with the key in the slot in the shift console, the key functions are activated automatically.

Removing and inserting the emergency key element

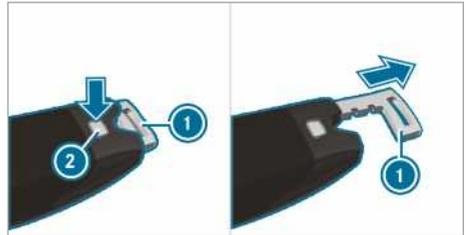

▶ **To remove:** press release button . Emergency key element  is pushed slightly out.

▶ Pull emergency key element  out completely.

▶ **To insert:** press release button .

▶ Slide emergency key element  in completely until it engages.

Replacing the key battery

⚠ DANGER Serious damage to health caused by swallowing batteries

Batteries contain toxic and corrosive substances. Swallowing batteries may cause serious damage to health.

There is a risk of fatal injury.

▶ Keep batteries out of the reach of children.

▶ If batteries are swallowed, seek medical attention immediately.

 **ENVIRONMENTAL NOTE** Environmental damage due to improper disposal of batteries



Batteries contain pollutants. It is illegal to dispose of them with the household rubbish.



Dispose of batteries in an environmentally responsible manner. Take discharged batteries to a qualified specialist workshop or to a collection point for used batteries.

Requirements:

- a CR 2032 3 V cell battery

Mercedes-Benz recommends that you have the battery replaced by a qualified specialist workshop.

- ▶ Remove the emergency key (→ page 46).



Example image

- ▶ Press release button ② down fully and slide cover ① forward.
- ▶ Remove battery compartment ③ and remove the discharged battery.
- ▶ Insert the new battery into battery compartment ③. Observe the positive pole marking in the battery compartment and on the battery.
- ▶ Insert battery compartment ③.
- ▶ Replace cover ① so that it engages.
- ▶ Slide emergency key element in completely until it engages (→ page 46).

Problems with the key

Problem	Possible causes/consequences and ▶ Solutions
You cannot lock or unlock the vehicle any more.	<p>Possible causes:</p> <ul style="list-style-type: none"> • the key battery is weak or discharged • there is interference from a powerful source of radio waves • the key is faulty <p>▶ Check the battery using the battery check lamp and replace if necessary (→ page 46).</p> <p>▶ Use the emergency key element to unlock and lock the vehicle (→ page 46).</p> <p>▶ Have the key checked at a qualified specialist workshop.</p>
You have lost a key.	<p>▶ Have the key deactivated at a qualified specialist workshop.</p> <p>▶ If necessary, have the mechanical locks replaced.</p>

Doors

Notes on the additional door lock

The additional door lock is only available for vehicles for the United Kingdom.

⚠ WARNING Risk of injury to persons inside the vehicle when the additional door lock is activated

If the additional door lock is activated, the doors can no longer be opened from the inside.

If there are persons in the vehicle, they can no longer leave the vehicle, e.g. in hazardous situations.

- ▶ Never leave persons unattended in the vehicle, particularly children, elderly persons or persons in need of help.
- ▶ If there are persons in the vehicle, do not activate the additional door lock.

The additional door lock is automatically activated:

- after the vehicle has been locked with the key

You can deactivate the additional door lock by deactivating the interior motion sensor (→ page 62).

- ① The additional door lock is inoperative on vehicles without an interior motion sensor.

Unlocking and opening the door from inside

United Kingdom only: observe the notes on the additional door lock (→ page 47).

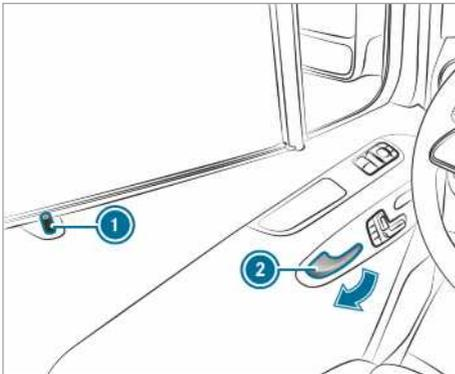

- ▶ **To unlock and open the front door:** pull door handle ②. Locking pin ① pops up when the door is unlocked.
- ▶ Open the door.

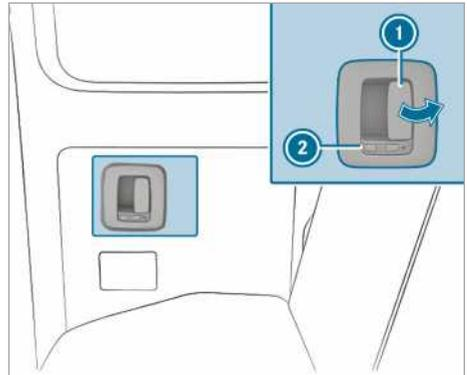

The  symbol indicates that the rear door is unlocked.

- ▶ **To unlock and open the rear door:** pull opening lever ① and open the rear door. When the door unlocks, latch ② moves forward. The  symbol is visible.
- ▶ **To close:** pull the rear door closed by the door handle.
- ▶ **To lock:** slide latch ② down. The  symbol is visible.

Locking the door centrally from inside

⚠ WARNING Risk of accident and injury due to children left unattended in the vehicle

If children are left unattended in the vehicle, they could:

- open doors, thereby endangering other persons or road users.
- get out of the vehicle and be hit by oncoming traffic.
- operate vehicle equipment and become trapped, for example.

In addition, children could also set the vehicle in motion, for example, by:

- releasing the parking brake.
- shifting the automatic transmission out of park position **P** or shifting manual transmission into neutral.
- starting the engine.

- ▶ When leaving the vehicle, always take the key with you and lock the vehicle.
- ▶ Never leave children and animals unattended in the vehicle.
- ▶ Keep the vehicle key out of reach of children.

⚠ WARNING Risk of fatal injury due to exposure to extreme heat or cold in the vehicle

If people – particularly children – are exposed to extreme temperatures over an extended period of time, there is a risk of serious or even fatal injury!

- ▶ Never leave anyone – particularly children – unattended in the vehicle.
- ▶ Never leave animals in the vehicle unattended.

Locking and unlocking manually

You can use the central locking buttons to centrally lock and unlock the entire vehicle from the inside.

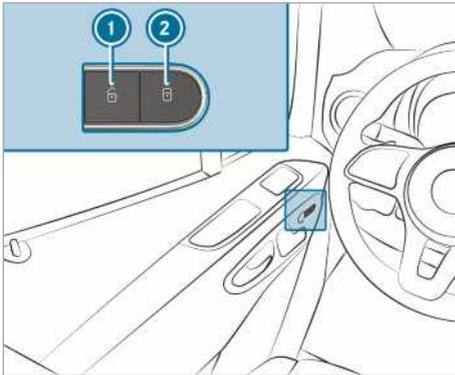

- ▶ **To lock/unlock the entire vehicle:** press button ① (unlock) or ② (lock) when the doors are closed.

Switching the automatic locking feature on or off

When the ignition is switched on and the vehicle is driving at a speed above 15 km/h, the vehicle locks automatically.

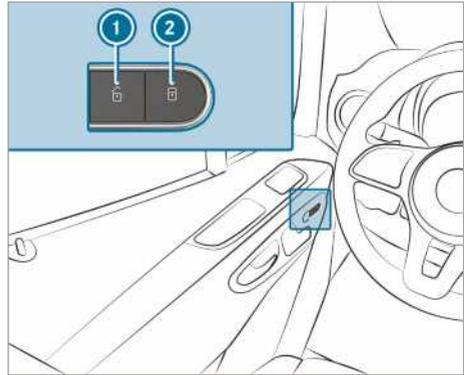

There is a danger of being locked out when the function is activated in the following situations:

- when tow-starting or pushing the vehicle
- on the roller dynamometer

- ▶ When the doors are closed, switch on the power supply or ignition.
- ▶ **To switch on:** press and hold button ② for approximately five seconds. An acoustic signal sounds.
- ▶ **To switch off:** press and hold button ① for approximately five seconds. An acoustic signal sounds.

Unlocking/locking the driver's door with the emergency key element

- ① If you want to lock the vehicle completely with the emergency key element, press the button for the locking mechanism from inside first with the driver's door open. Then lock the driver's door with the emergency key element.

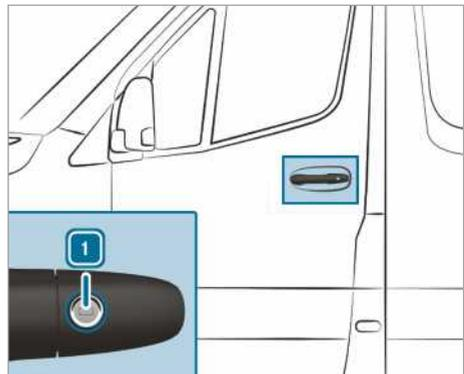

▶ **To unlock:** turn the emergency key element left to position **1**.

▶ **To lock:** turn the emergency key element right to position **1**.

① **Right-hand drive vehicles:** turn the emergency key in the opposite direction in each case.

Sliding door

Opening/closing the sliding door from outside

▲ WARNING Risk of entrapment by open sliding door which is not engaged

If the open sliding door is not engaged, it could move on its own if the vehicle is on a slope.

This could trap you or other persons.

▶ Always make sure that the open sliding door is engaged. Open the sliding door as far as it will go.

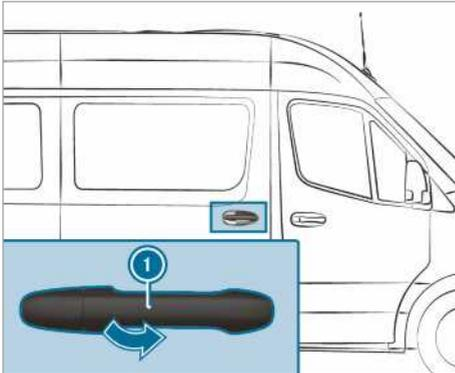

① Your vehicle may be equipped with a long sliding door with an intermediate detent. You can also lock the sliding door in place around halfway when opening and closing. If you do this, the door does not have to be opened fully when getting into or out of the vehicle. The sliding door is not fully engaged when in the intermediate detent.

▶ **To open:** pull door handle **1**.
The sliding door opens.

▶ Push back the sliding door using door handle **1** until it engages.

▶ Check the sliding door detent.

▶ **To close:** pull the sliding door by handle **1** and firmly slide it forwards until it closes.

Opening/closing the sliding door from inside

▲ WARNING Risk of entrapment by open sliding door which is not engaged

When you open the sliding door, the sliding door could hit other people as it moves backwards.

▶ Only open the sliding door when traffic conditions permit.

Requirements:

- The child safety lock is deactivated.

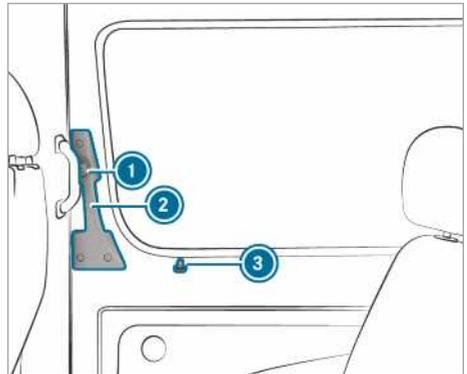

Locking pin **3** pops up when you open a locked door. All doors are unlocked.

① Your vehicle may be equipped with a long sliding door with an intermediate detent. You can also lock the sliding door in place around halfway when opening and closing. If you do this, the door does not have to be opened fully when getting into or out of the vehicle. The sliding door is not fully engaged when in the intermediate detent.

▶ **To open:** press button **1**.

▶ Slide the sliding door by handle **2** back to the stop.

▶ Check the sliding door detent. The sliding door must be engaged.

▶ **To close:** press button **1**.

▶ Slide the sliding door firmly forwards by handle **2** until it closes.

Notes on electrical closing assist

If your vehicle is fitted with electrical closing assist, you will require less force to close the sliding door.

Electrical sliding door

Function of the electric sliding door

Your vehicle can be equipped with an electric sliding door on the left and/or right-hand side.

You can operate the electric sliding door in the following ways:

- by pressing the sliding door buttons on the centre console
- by pressing the sliding door button on the door sill (B-pillar)
- using the door handle (inside or outside)
- using the key

If the electric sliding door is obstructed while opening, it moves a few centimetres in the opposite direction and stops.

If the sliding door is obstructed during the closing procedure, it opens fully again.

If the electric motor of the sliding door is in danger of overheating, e.g. due to frequent opening and closing within a short period, the sliding door opens fully. The sliding door is then locked in place. The sliding door is operational again after approximately 30 seconds.

If there has been a malfunction or if the battery has been disconnected, you can use the release catch to disconnect the sliding door from the electric motor. Then you can open or close the door manually (→ page 52).

Opening/closing the electric sliding door with the button

⚠ WARNING Risk of entrapment by open sliding door which is not engaged

When you open the sliding door, the sliding door could hit other people as it moves backwards.

- ▶ Only open the sliding door when traffic conditions permit.

⚠ WARNING Risk of injury despite obstacle detection

Obstacle detection does not react to soft, light and thin objects, such as fingers. These or other parts of the body could be pressed against the door frame, for instance. Obstacle detection cannot prevent entrapment in these instances.

- ▶ When opening and closing the electric sliding door, make sure that nobody is within the operating range of the sliding door.
- ▶ If someone becomes trapped, press the button again to stop the sliding door.

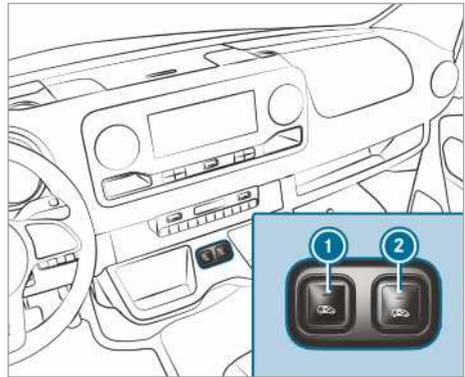

Sliding door buttons on the centre console

- ① Opens and closes the sliding door on the left side of the vehicle
- ② Opens and closes the sliding door on the right side of the vehicle



Sliding door button on the door sill (B-pillar)

On vehicles with a partition, button ③ is located on the partition next to the doorway at the level of the inside door handle.

You can only open the sliding door with button

- ③ if the child-safety lock is not activated.

- ▶ **To open:** briefly press button ①, ② or button ③.

The sliding door opens automatically.

When you open the door using button ① or ②, you will additionally hear two warning signals.

The indicator lamp at the top of button ① or ② will flash and button ③ will flash.

When the sliding door is completely open, the indicator lamp at the top of button ① or ② will light up.

- ▶ **To close:** briefly press button ①, ② or button ③.

The sliding door closes automatically.

When you close the door using button ① or ②, you will additionally hear two warning signals.

The indicator lamp at the top of button ① or ② will flash and button ③ will flash.

When the sliding door is completely closed, the indicator lamp at the top of button ① or ② will go out.

- ▶ **To stop automatic operation:** briefly press button ① or ②.

The sliding door stops moving.

- ① When you stop automatic operation upon opening the door, the door closes when you press the button again.
- ① In unfavourable operating conditions, e.g. frost, ice or heavy soiling, you can press and hold the corresponding button. The electric sliding door moves with increased force. Observe that, in such circumstances, the obstacle detection is less sensitive. To stop the movement, release the button.

Opening/closing the electric sliding door with the key

- ▶ **To unlock:** briefly press the  or  button on the key.

- ▶ **To open:** press and hold the  or  button on the key for longer than 0.5 seconds.

You will hear two acoustic signals and the sliding door will open automatically.

- ▶ **To close:** press and hold the  or  button on the key for longer than 0.5 seconds.

You will hear two acoustic signals and the sliding door will close automatically.

- ▶ **To interrupt automatic operation:** briefly press the  or  button on the key. The sliding door stops moving.

- ① When you stop automatic operation upon opening the door, the door closes when you press the button again.

Opening/closing the electric sliding door with the door handle

Requirements:

- The child safety lock is deactivated.

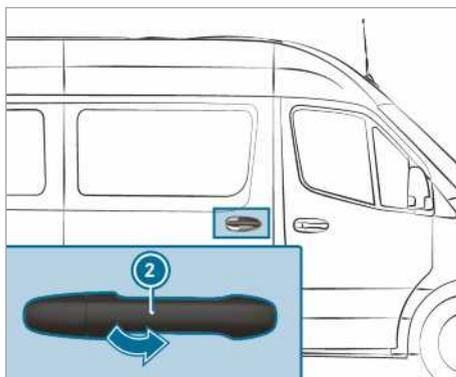
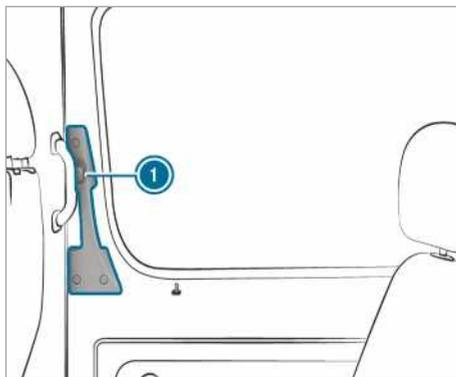

- ▶ Press button ① or pull outside handle ②. The sliding door opens or closes.
- ▶ Press button ① again or pull outside handle ②. The sliding door stops moving.

Unlocking the electric sliding door manually

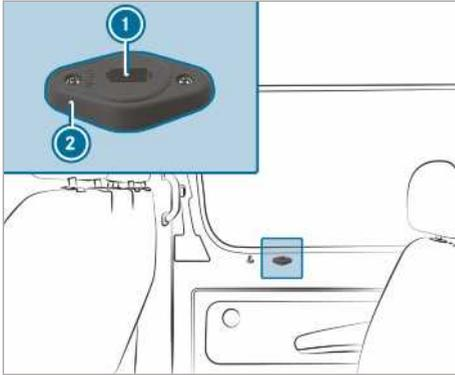

If there has been a malfunction or if the battery has been disconnected, you can use release catch ② to disconnect the sliding door from the electric motor. Then, you can open or close the door manually.

i For further information on removing the emergency key (→ page 46)

- ▶ **Vehicles with complete sliding door trim:** remove the cover from release catch ②. Service operation is accessible.
- ▶ **To disconnect the sliding door from the electric motor:** insert the emergency key element into opening ① of release catch ② in the "AUTO" position.
- ▶ Turn the emergency key 180° clockwise. The "MAN" position is set.
- ▶ Open or close the sliding door with the outside or inside door handle.
- ▶ **To connect the sliding door to the electric motor:** insert the emergency key element into opening ① of release catch ② in the "MAN" position.
- ▶ Turn the emergency key 180° anti-clockwise. The "AUTO" position is set.
- ▶ Adjust the sliding door (→ page 53).

If it is not possible to rectify the malfunction:

- ▶ Visit a qualified specialist workshop.

Resetting the electric sliding door

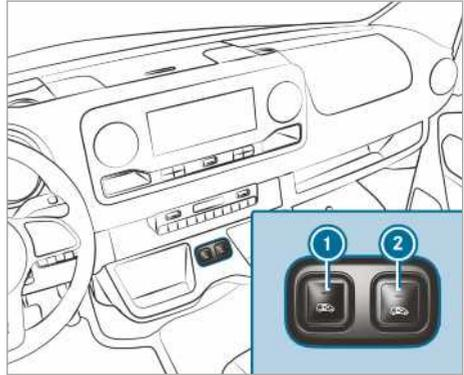

Sliding door buttons on the centre console

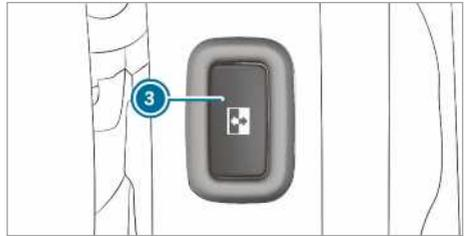

Sliding door button on the door sill (B-pillar)

You must reset the sliding door if there has been a malfunction or a voltage supply interruption.

- ▶ If the sliding door is open: press button ① or ② on the centre console or sliding door button ③ on the door sill (B-pillar) and hold until the door is closed.

or

- ▶ Close the sliding door with the door handle (→ page 52).
- ▶ Then briefly press button ① or ② on the centre console or sliding door button ③ on the door sill (B-pillar) once, or pull the door handle (→ page 52) to completely open the sliding door.
- ▶ The sliding door is operational.

Rear-end doors

Opening and closing the rear doors from outside

▲ WARNING Risk of accident and injury when opening the rear door in poor traffic conditions

When you open a rear door, the following is possible:

- other people or road users may be endangered
- you may be caught by oncoming traffic

This is particularly the case if you open the rear door more than 90°.

- ▶ Only open the rear doors when traffic conditions permit.
- ▶ Always make sure that the rear doors are properly locked.

Opening the rear right door

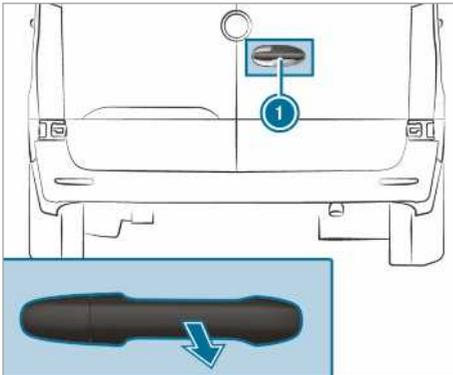

- ▶ Pull handle ①.
- ▶ Swing the rear-end door to the side until it engages.

Opening the rear left door

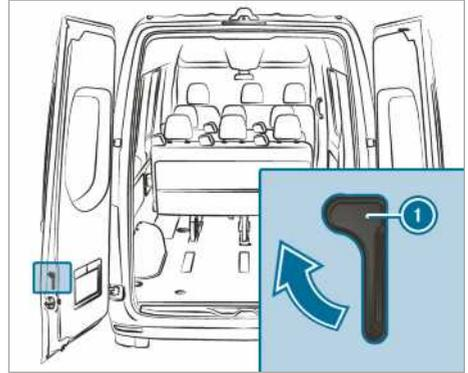

- ▶ Make sure that the rear right door is open and engaged.
- ▶ Pull release handle ① in the direction of the arrow.
- ▶ Swing the rear-end door to the side until it engages.

Opening the rear doors fully

- ▶ Open the relevant rear door out past the first detent (90°).
- ▶ Open the rear door fully. The rear door will stay in the stop position.

Closing the rear doors from outside

- ▶ Close the rear left door firmly from outside.
- ▶ Close the rear right door firmly from outside.

Opening/closing the rear-end doors from the inside

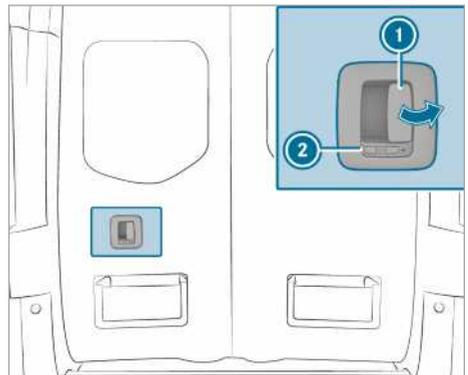

The  symbol indicates that the rear-end door is unlocked.

- ▶ **To unlock:** slide latch **2** to the left. The  symbol is visible.
- ▶ **To open:** pull opening lever **1** up and open the rear-end door.
- ▶ Swing the rear-end door to the side until it engages.
- ▶ **To close:** make sure that the rear left door is closed.
- ▶ Pull the rear right door firmly to by the door handle.
- ▶ **To lock:** slide latch **2** to the right. The  symbol is visible.

Partition sliding door

Opening and closing the partition sliding door from the driver's compartment

⚠ WARNING Risk of becoming trapped due to non-engaged partition sliding door

If the open partition sliding door is not engaged, it can move on its own while the vehicle is in motion.

This can cause you or other people to become trapped.

- ▶ Before driving, always close the partition sliding door and ensure that it is engaged.

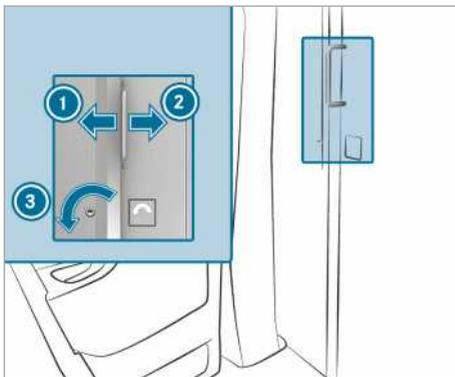

- ▶ **To open:** turn the key to the left **3**. The sliding door is unlocked.
- ▶ Slide the sliding door to the right **2** as far as it will go.

- ▶ **To close:** slide the sliding door to the left **1** until it engages. You can lock the sliding door with the key.

Opening and closing the partition sliding door from the load compartment

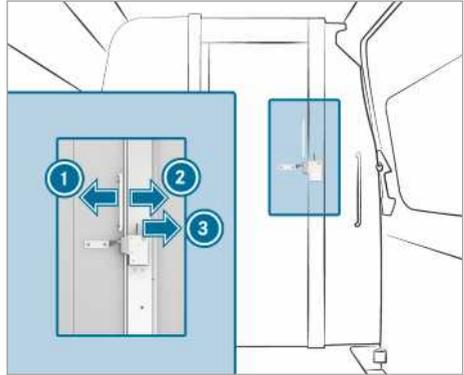

- ▶ **To open:** push the lever to the right **3**. The sliding door is unlocked.
- ▶ Slide the sliding door to the left **1** as far as it will go.
- ▶ **To close:** slide the sliding door to the right **2** until it engages.

Electrical step

Function of the electrical step

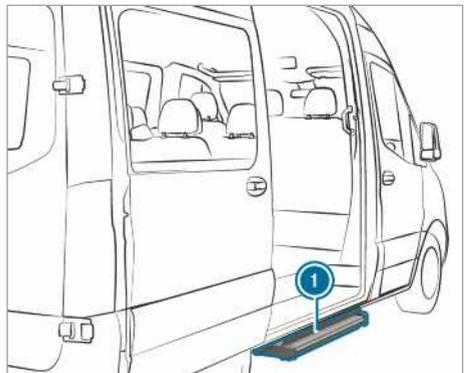

Your vehicle's sliding door may be equipped with an electrical step.

Electrical step **1** automatically extends when the sliding door opens, and retracts after the sliding door closes. Electrical step **1** is equipped

with obstacle detection at the front. If the step meets an obstacle while extending, it stops. When you have removed the obstacle, you must first close the sliding door then re-open it so that the step extends completely.

If the electrical step prevents loading, you can block it via obstacle detection when the sliding door opens. The electrical step then remains retracted and a fork-lift truck or other lifting vehicle can move closer to the load area.

- ❶ The display shows the **Step not extended** See Owner's Manual message or the **step not extended malfunction** message.

When the ignition is switched off, a warning tone sounds if obstacle detection is blocked. The tone lasts two minutes.

When the ignition is switched on, the warning tone sounds continuously.

Vehicles with an instrument display (colour display): if the display shows the **Step not retracted** See Owner's Manual message or **Step not extended** See Owner's Manual message and a warning tone sounds, electrical step ❶ is malfunctioning (→ page 382).

Vehicles with an instrument display (black and white display): if the display shows the **step not retracted malfunction** message or **step not extended malfunction** message and a warning tone sounds, electrical step ❶ is malfunctioning (→ page 382).

If electrical step ❶ is malfunctioning, the step may not extend or retract, or only partially. After a malfunction occurs, you must retract and lock electrical step ❶ manually in order to continue driving (→ page 56). Before passengers exit the vehicle, inform them that electrical step ❶ may be missing.

Releasing the electrical step in an emergency (manual retraction)

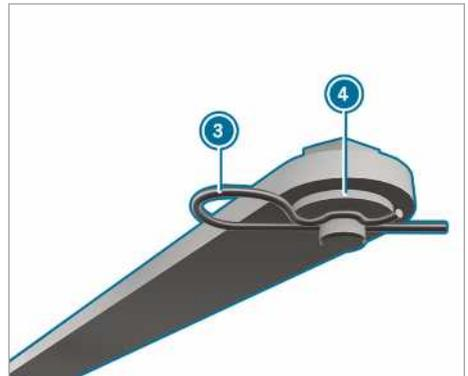
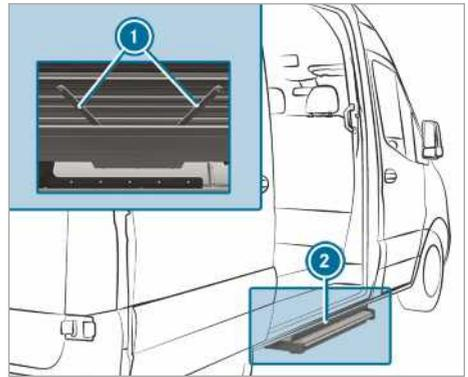

If the electrical step does not automatically retract, you must manually retract the step and lock it in order to continue driving.

- ▶ On the underside of step ❷ on both bars ❶ remove the spring cotters ❸ from the pin.
- ▶ Remove the washers ❹ and detach both bars.

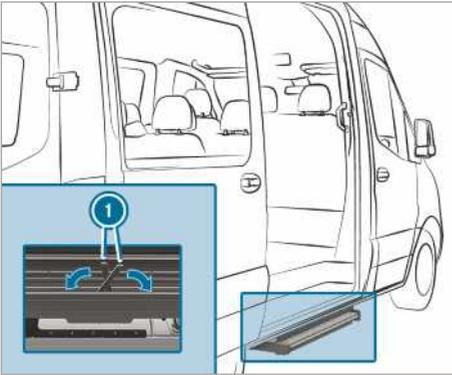

- ▶ Fold the bars ① into the step's housing.
- ▶ Slide the step into its housing.

ⓘ When securing the step for the first time, you must puncture a foil with the spring cotters.

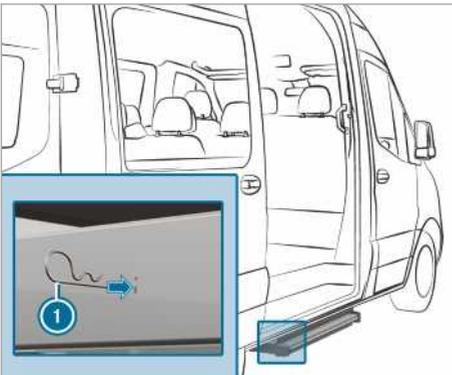

- ▶ On both sides, insert the spring cotters ① through the housing's holes and into the step as far as they will go.
- The step has been secured in its housing.

Platform dropsides

Opening and closing platform dropsides

⚠ WARNING Risk of injury when opening a loaded dropside!

When opening the dropside locking mechanisms, the dropside may drop down. This is particularly the case if it is loaded, i.e. carrying a load.

- ▶ Before opening, ensure that there are no people in the dropside's swivel range.
- ▶ Always open the dropside locking mechanisms at the side of the dropside to be opened.
- ▶ Be particularly careful if the dropside locking mechanisms cannot be opened using the usual level of force.

⚠ WARNING Risk of accident if the exterior lighting is covered by the dropside.

The exterior lighting at the rear is concealed when you open the rear dropside.

As a result, other road users cannot detect the vehicle as an obstacle until late.

- ▶ Protect the vehicle at the rear in accordance with national regulations, e.g. with a warning triangle.

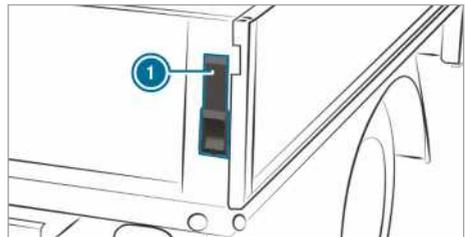

- ▶ **To open:** hold the platform dropside firmly.
- ▶ Fold lever ① up as far as it will go.
- ▶ Repeat the procedure on the other side of the platform dropside.
- ▶ Fold the platform dropside up to the 90° position.

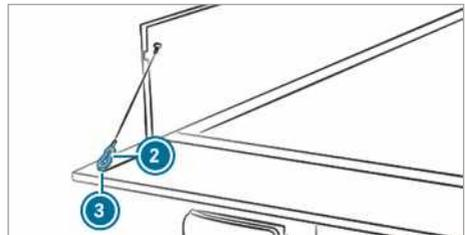

- ▶ Raise the platform dropside and unhook holding rope snap hook ② from eyelet ③.
- ▶ Repeat the procedure on the other side of the platform dropside.

- ▶ Carefully fold down the platform dropside.
- ▶ **To close:** raise the platform dropside and hook holding rope snap hook ② into eyelet ③.
- ▶ Raise the platform dropside and press it closed.
- ▶ Fold lever ① down as far as it will go.
- ▶ Repeat the procedure on the other side of the platform dropside.

Attaching/detaching side platform dropsides

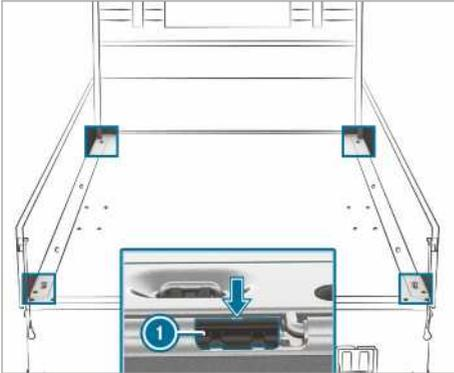

Perform these jobs carefully with the assistance of a second person.

- ▶ **To detach:** fold down the rear platform dropside.
- ▶ Fold down a side platform dropside.
- ▶ Lever locking pawl ① of the side platform dropside out of its guide using the screwdriver from the vehicle tool kit in the recess (arrow).
- ▶ Fold the platform dropside upwards to the 80° position (approximately).
- ▶ Pull the platform dropside out of the hinge pins to the rear and remove it.
- ▶ **To attach:** carefully place the platform dropside against the hinge pins in the 80° position (approximately); the locking pawl ① must lie on the platform dropside.
- ▶ Slide the platform dropside forwards.
- ▶ Insert locking pawl ① and fold up the platform dropside.

Side window

Opening and closing the side windows

- ▲ **WARNING** Risk of becoming trapped when opening a side window

When you open a side window, parts of the body could be drawn in or become trapped between the side window and window frame.

- ▶ When opening, make sure that nobody is touching the side window.
- ▶ If someone is trapped, release the button immediately or pull it in order to close the side window again.

- ▲ **WARNING** Risk of becoming trapped when closing a side window

When closing a side window, body parts could be trapped in the closing area in the process.

- ▶ When closing, make sure that no body parts are in the closing area.
- ▶ If someone is trapped, release the button immediately or press the button in order to reopen the side window.

- ▲ **WARNING** Risk of becoming trapped when children operate the side windows

Children could become trapped if they operate the side windows, particularly when unattended.

- ▶ Activate the override feature for the rear side windows.
- ▶ When leaving the vehicle, always take the key with you and lock the vehicle.
- ▶ Never leave children unattended in the vehicle.

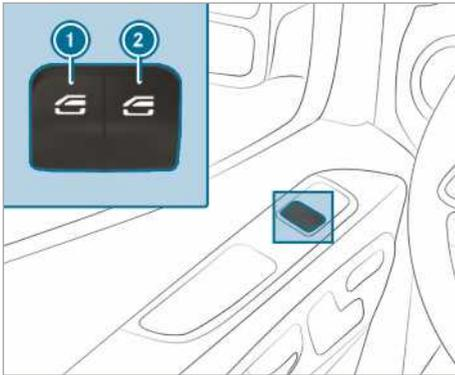

- ① Power window, left
- ② Power window, right

- ▶ **To open manually:** press and hold button ① or ②.
- ▶ **To close manually:** pull and hold button ① or ②.

The windows in the front doors can also be operated automatically.

- ▶ **To open completely:** briefly press button ① or ② beyond the point of resistance. Automatic operation will start.
- ▶ **To close completely:** briefly pull button ① or ② beyond the point of resistance. Automatic operation will start.
- ▶ **To interrupt automatic operation:** briefly press or pull button ① or ② again.
- ⓘ If an object blocks a side window during the automatic closing process, the side window will open again automatically. The automatic reversing function is only an aid and is not a substitute for your attentiveness.
- ⓘ If automatic operation of the side windows does not work, there is no anti-entrapment function.

Automatic reversing function of the side windows

If an object blocks a side window during the closing process, the side window will open again automatically. The automatic reversing function is only an aid and is not a substitute for your attentiveness.

- ▶ During the closing process, make sure that no body parts are in the closing area.

⚠ WARNING Risk of becoming trapped despite there being reverse protection on the side window

The reverse function does not react:

- to soft, light and thin objects, e.g. fingers
- over the last 4 mm of the closing path
- during resetting
- when the side window is closed again manually immediately after automatic reversing

This means that the reverse function cannot prevent someone from becoming trapped in these situations.

- ▶ During the closing process, make sure that no body parts are in the closing area.
- ▶ If someone becomes trapped, press the  button to open the side window again.

Ventilating the vehicle before starting a journey (convenience opening)

⚠ WARNING Risk of entrapment when opening a side window

When opening a side window, parts of the body could be drawn in or become trapped between the side window and window frame.

- ▶ When opening, make sure that nobody is touching the side window.
- ▶ Release the button immediately if somebody becomes trapped.

You can ventilate the vehicle before you start driving.

To do this, the key is used to carry out the following functions simultaneously:

- unlock the vehicle
- open the side windows

The "convenience opening" function can only be operated using the key. The key must be in close proximity to the driver's or co-driver's door.

- ▶ Press and hold the  button on the key.

The following functions are performed:

- the vehicle is unlocked
- the side windows are opened

- ▶ **To interrupt convenience opening:** release the  button.

Closing side windows from the outside (convenience closing)

▲ WARNING Risk of entrapment caused by inadvertent convenience closing

When the convenience closing feature is operating, parts of the body could become trapped in the closing area of the side windows.

- ▶ Observe the complete closing procedure when using convenience closing.
- ▶ When closing, make sure that no body parts are in the closing area.

- ▶ Press and hold the  button on the key. The following functions are performed:
- the vehicle is locked
 - the side windows are closed
- ▶ **To interrupt convenience closing:** release the  button.

Adjusting the side windows

The side windows must be readjusted after a malfunction or a voltage supply interruption.

- ▶ Switch on the ignition (→ page 114).
- ▶ Push both buttons on the power window and hold for approximately one second after the side window has closed.

Problems with the side windows

Problem	Possible causes/consequences and ▶ Solutions
<p>A side window cannot be closed and the cause is not obvious.</p>	<p>▶ Check to see if there are any objects in the window guide.</p> <div style="border: 1px solid black; padding: 5px; margin: 10px 0;"> <p>▲ WARNING Risk of becoming trapped or fatally injured if reversing protection is not activated</p> <p>If you close a side window again immediately after it has been blocked, the side window will close with increased or maximum force. The reversing feature will then not be active.</p> <p>Parts of the body could become trapped in the closing area in the process.</p> <ul style="list-style-type: none"> ▶ Make sure that no parts of the body are in the closing area. ▶ To stop the closing process, release the button or press the button again to re-open the side window. </div> <p>If a side window is obstructed during closing, and reopens again slightly, you can proceed as follows:</p> <p>▶ Immediately after the window is obstructed, pull the corresponding button again until the side window has closed, and hold the button for an additional second. The side window is closed with increased force.</p> <p>If the side window is obstructed again and reopens slightly, you can proceed as follows:</p> <p>▶ Repeat the previous step. The side window is closed without the automatic reversing function.</p>
<p>The side windows cannot be opened or closed using the convenience opening feature.</p>	<p>The key battery is weak or discharged.</p> <p>▶ Check the battery with the battery indicator lamp and replace if necessary (→ page 46).</p>

Anti-theft protection

Function of immobiliser

The immobiliser prevents your vehicle from being started without the correct key.

The immobiliser is automatically activated when the ignition is switched off, and deactivated when the ignition is switched on.

ATA (Anti-Theft Alarm system)

Function of ATA (Anti-theft Alarm system)

If the ATA system is primed, a visual and audible alarm is triggered in the following situations:

- a side door is opened
- the rear door is opened
- the bonnet is opened
- the interior motion sensor is triggered (→ page 62)
- tow-away protection is triggered (→ page 61)

ATA is automatically primed after approximately five seconds in the following situation:

- after the vehicle has been locked with the key

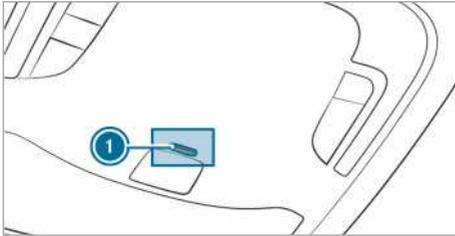

When the ATA system is primed, indicator lamp ① flashes in the overhead control panel.

ATA is automatically deactivated in the following situations:

- After unlocking the vehicle with the key.
- After pressing the start/stop button with the key inside the vehicle.

Priming/deactivating ATA (Anti-theft Alarm system)

If the alarm system is primed, a visual and audible alarm is triggered in the following situations:

- a door is opened
- the bonnet is opened

- ① The alarm is not deactivated, even if you immediately close the open door that has triggered it, for example.

Priming

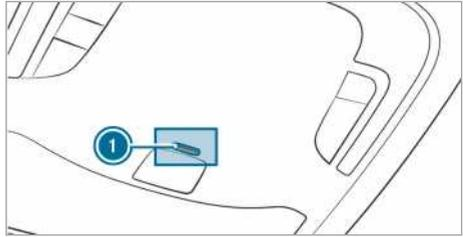

- ▶ Close all the doors.
- ▶ Lock the vehicle with the key. Indicator lamp ① in the overhead control panel flashes.

Switching off

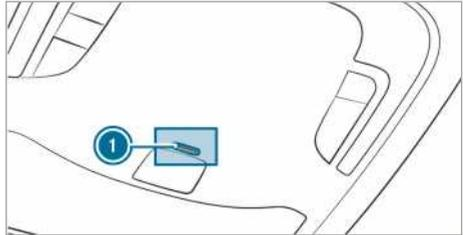

- ▶ Unlock the vehicle with the key. Indicator lamp ① in the overhead control panel goes out.
- ① The vehicle locks again automatically if you do not open a door within 40 seconds after unlocking the vehicle.

Stopping the alarm

- ▶ Press the  or  button on the key.
- or
- ▶ Press the Start/Stop button with the key inside the vehicle. The alarm stops.

Function of tow-away protection

Function of tow-away protection

A visual and audible alarm is triggered if the inclination of the vehicle changes when tow-away protection is primed. This can be the case if the vehicle is raised on one side, for example.

Priming/deactivating tow-away protection

Priming/deactivating

- ▶ Lock the vehicle with the key.
Tow-away protection is automatically primed after about 40 seconds:
- ▶ Open the vehicle with the key.
Tow-away protection is deactivated.

Tow-away protection is only primed when the following components are closed:

- the driver's door and the co-driver door
- the side doors
- the rear doors

Deactivating

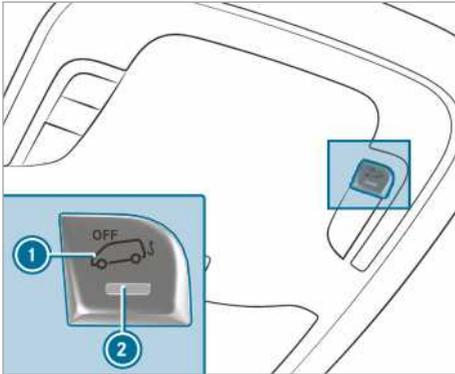

- ▶ Switch off the power supply (→ page 114).
- ▶ Press button ①.
When the button is released, indicator lamp ② in the button lights up for approximately five seconds.
- ▶ Lock the vehicle with the key.
Tow-away protection is deactivated.

Tow-away protection remains deactivated until you lock the vehicle again.

Deactivate tow-away protection when locking your vehicle in the following situations:

- when loading and/or transporting the vehicle on a ferry or car transporter, for example
- when parking the vehicle on a movable surface, such as a split-level garage

This will prevent false alarms.

Interior motion sensor

Function

If the primed interior motion sensor detects motion in the vehicle interior, a visual and acoustic alarm is triggered. This can happen if someone reaches into the vehicle interior, for example.

Priming/deactivating the interior motion sensor

Priming

- ▶ Close the side windows.
- ▶ Make sure that nothing (such as mascots or coat hangers) is hanging on the rear-view mirror or on the grab handles on the roof lining. This will prevent false alarms.
- ▶ Lock the vehicle with the key.
The interior motion sensor is primed after approximately 30 seconds.

Interior protection is only primed when the following components are closed:

- the driver's door and the co-driver door
- the side doors
- the rear doors

Deactivating

- ▶ Unlock the vehicle with the key.
The interior motion sensor automatically switches off.

Deactivating

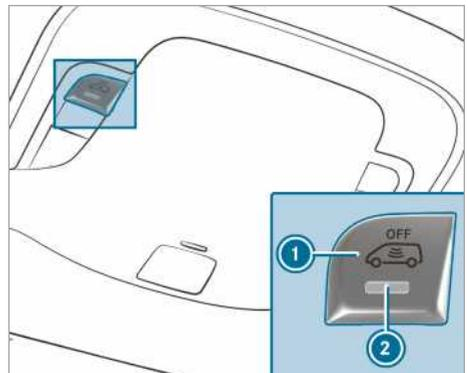

- ▶ Switch off the power supply (→ page 114).

- ▶ Press button ①.
When the button is released, indicator lamp ② in the button lights up for about five seconds.
- ▶ Lock the vehicle with the key.
The interior motion sensor is deactivated.

The interior motion sensor remains deactivated until you lock the vehicle again.

Deactivate the interior motion sensor when locking your vehicle in the following situations:

- if there are people or animals remaining inside
- if the side windows remain open
- when transporting the vehicle on a ferry or car transporter, for example

This will prevent false alarms.

Correct driver's seat position

⚠ WARNING Risk of injury through adjusting vehicle settings while the vehicle is in motion

You could lose control of the vehicle in the following situations:

- if you adjust the driver's seat, the head restraints, the steering wheel or the mirror while the vehicle is in motion
- if you fasten your seat belt while the vehicle is in motion

▶ Before starting the engine: adjust the driver's seat, the head restraints, the steering wheel or the mirror and fasten your seat belt.



Comply with the following when adjusting the steering wheel ③, safety belt ② and driver's seat ①:

- Sit as far away as possible from the driver's airbag.
- Sit in an upright position.
- Your thighs are slightly supported by the seat cushion.
- Your legs are not fully extended and you can easily fully press on the pedals.
- The back of your head is supported at eye level by the middle part of the head restraint.
- You can reach the steering wheel with your arms in a slightly bent position.
- You can move your legs freely.
- You can easily see all displays on the instrument display.

- You have a good overview of the traffic situation.
- Your safety belt fits securely around your body and runs across the middle of your shoulder, your pelvic area and groin.

Seats

Adjusting the front seats manually (without Seat Comfort Package)

⚠ WARNING Risk of becoming trapped if the seats are adjusted by children

Children could become trapped if they adjust the seats, particularly when unattended.

- ▶ When leaving the vehicle, always take the key with you and lock the vehicle.
- ▶ Never leave children unattended in the vehicle.

⚠ WARNING Risk of becoming trapped when adjusting the seats

When you adjust a seat, you or other vehicle occupants could become trapped, e.g. on the seat guide rail.

- ▶ When adjusting a seat, make sure that no one has any body parts in the sweep of the seat.

Observe the safety notes on "Airbags" and "Children in the vehicle".

⚠ WARNING Risk of accident due to the driver's seat not being engaged

If the driver's seat is not engaged, it could move unexpectedly while the vehicle is in motion.

This could cause you to lose control of the vehicle.

- ▶ Always make sure that the driver's seat is engaged before starting the vehicle.

⚠ WARNING Risk of injury through adjusting vehicle settings while the vehicle is in motion

You could lose control of the vehicle in the following situations:

- if you adjust the driver's seat, the head restraints, the steering wheel or the mirror while the vehicle is in motion
 - if you fasten your seat belt while the vehicle is in motion
- ▶ Before starting the engine: adjust the driver's seat, the head restraints, the steering wheel or the mirror and fasten your seat belt.

⚠ WARNING Risk of becoming trapped if the seat height is adjusted carelessly

If you adjust the seat height carelessly, you or other vehicle occupants could be trapped and thereby injured.

Children in particular could accidentally press the electrical seat adjustment buttons and become trapped.

- ▶ While moving the seats, make sure that hands or other body parts do not get under the lever assembly of the seat adjustment system.

⚠ WARNING Risk of injury due to head restraints which are not fitted or are adjusted incorrectly

If head restraints are not fitted or are adjusted incorrectly, they cannot provide protection as intended.

There is an increased risk of injury in the head and neck area, e.g. in the event of an accident or when braking.

- ▶ Always drive with the head restraints fitted.
- ▶ Before driving off, make sure for every vehicle occupant that the centre of the head restraint supports the back of the head at about eye level.

Do not interchange the head restraints of the front and rear seats. Otherwise, you will not be able to adjust the height and angle of the head restraints correctly.

Adjust the head restraint fore-and-aft position so that it is as close as possible to the back of your head.

⚠ WARNING Risk of injury or death due to incorrect seat position

The seat belt does not offer the intended level of protection if you have not moved the seat backrest to an almost vertical position.

When braking or in the event of an accident, you could slide underneath the seat belt and sustain abdominal or neck injuries, for example.

- ▶ Adjust the seat properly before beginning your journey.
- ▶ Always ensure that the seat backrest is in an almost vertical position and that the shoulder section of your seat belt is routed across the centre of your shoulder.

ⓘ NOTE Damage to the seats when moving the seats back

The seats may be damaged by objects when moving the seats back.

- ▶ When moving the seats back, make sure that there are no objects in the footwell, under or behind the seats.

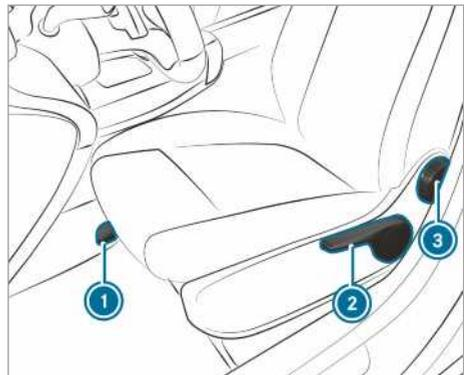

- ① Seat fore-and-aft position
- ② Seat height
- ③ Seat backrest inclination

ⓘ Depending on the seat model, individual adjustment options may be omitted.

▶ **To adjust the seat fore-and-aft position:** lift lever ① and slide the seat into the desired position.

▶ Make sure that the seat is engaged.

▶ **To set the seat height:** keep on pressing or pulling lever ② until the required seat height is reached.

▶ **To adjust the seat backrest inclination:** turn handwheel ③ forwards and backwards until the desired position has been reached.

Adjusting the front seats manually (with Seat Comfort Package)

▲ WARNING Risk of becoming trapped if the seats are adjusted by children

Children could become trapped if they adjust the seats, particularly when unattended.

- ▶ When leaving the vehicle, always take the key with you and lock the vehicle.
- ▶ Never leave children unattended in the vehicle.

▲ WARNING Risk of becoming trapped when adjusting the seats

When you adjust a seat, you or other vehicle occupants could become trapped, e.g. on the seat guide rail.

- ▶ When adjusting a seat, make sure that no one has any body parts in the sweep of the seat.

Observe the safety notes on "Airbags" and "Children in the vehicle".

▲ WARNING Risk of accident due to the driver's seat not being engaged

If the driver's seat is not engaged, it could move unexpectedly while the vehicle is in motion.

This could cause you to lose control of the vehicle.

- ▶ Always make sure that the driver's seat is engaged before starting the vehicle.

▲ WARNING Risk of injury through adjusting vehicle settings while the vehicle is in motion

You could lose control of the vehicle in the following situations:

- if you adjust the driver's seat, the head restraints, the steering wheel or the mirror while the vehicle is in motion
- if you fasten your seat belt while the vehicle is in motion

▶ Before starting the engine: adjust the driver's seat, the head restraints, the steering wheel or the mirror and fasten your seat belt.

▲ WARNING Risk of becoming trapped if the seat height is adjusted carelessly

If you adjust the seat height carelessly, you or other vehicle occupants could be trapped and thereby injured.

Children in particular could accidentally press the electrical seat adjustment buttons and become trapped.

▶ While moving the seats, make sure that hands or other body parts do not get under the lever assembly of the seat adjustment system.

▲ WARNING Risk of injury due to head restraints which are not fitted or are adjusted incorrectly

If head restraints are not fitted or are adjusted incorrectly, they cannot provide protection as intended.

There is an increased risk of injury in the head and neck area, e.g. in the event of an accident or when braking.

- ▶ Always drive with the head restraints fitted.
- ▶ Before driving off, make sure for every vehicle occupant that the centre of the head restraint supports the back of the head at about eye level.

Do not interchange the head restraints of the front and rear seats. Otherwise, you will not be able to adjust the height and angle of the head restraints correctly.

Adjust the head restraint fore-and-aft position so that it is as close as possible to the back of your head.

⚠ WARNING Risk of injury or death due to incorrect seat position

The seat belt does not offer the intended level of protection if you have not moved the seat backrest to an almost vertical position.

When braking or in the event of an accident, you could slide underneath the seat belt and sustain abdominal or neck injuries, for example.

- ▶ Adjust the seat properly before beginning your journey.
- ▶ Always ensure that the seat backrest is in an almost vertical position and that the shoulder section of your seat belt is routed across the centre of your shoulder.

! NOTE Damage to the seats when moving the seats back

The seats may be damaged by objects when moving the seats back.

- ▶ When moving the seats back, make sure that there are no objects in the footwell, under or behind the seats.



Sample image of comfort suspension seat

- ① Seat cushion length
- ② Seat backrest inclination
- ③ Seat height
- ④ Seat cushion inclination
- ⑤ Seat fore-and-aft position

- ⑥ Seat suspension
- ⑦ Vibration limiting

i Depending on the seat model, individual adjustment options may be omitted.

▶ **To adjust the seat cushion length:** lift lever ① and slide the front section of the seat cushion forwards or backwards.

▶ **To adjust the seat backrest inclination:** turn handwheel ② forwards and backwards until the desired position has been reached.

▶ **To adjust the seat height:** push or pull lever ③ until the desired position has been reached.

▶ **To adjust the seat cushion inclination:** turn handwheel ④ forwards and backwards until the desired position has been reached.

▶ **To adjust the seat fore-and-aft position:** lift lever ⑤ and slide the seat into the desired position.

▶ Make sure that the seat is engaged.

▶ **To set the seat suspension:** take the weight off the seat.

▶ On handwheel ⑥, set the body weight (40 kg to 120 kg) so that the seat suspension works optimally. If you set a higher weight, the seat suspension will become firmer. The seat will then not vibrate as much. If the seat vibrates often and significantly, you can engage the seat in the lower area.

▶ **To engage vibration limiting:** turn lever ⑦ upwards. The next time the seat vibrates, it will engage.

▶ **To release vibration limiting:** turn lever ⑦ to the right. The seat can vibrate.

Adjusting the front seat electrically

⚠ WARNING Risk of becoming trapped if the seats are adjusted by children

Children could become trapped if they adjust the seats, particularly when unattended.

- ▶ When leaving the vehicle, always take the key with you and lock the vehicle.
- ▶ Never leave children unattended in the vehicle.

The seats can be adjusted while the ignition is off.

⚠ WARNING Risk of becoming trapped when adjusting the seats

When you adjust a seat, you or other vehicle occupants could become trapped, e.g. on the seat guide rail.

- ▶ When adjusting a seat, make sure that no one has any body parts in the sweep of the seat.

Comply with the safety notes on "Airbags" and "Children in the vehicle".

⚠ WARNING Risk of accident due to the driver's seat not being engaged

If the driver's seat is not engaged, it could move unexpectedly while the vehicle is in motion.

This could cause you to lose control of the vehicle.

- ▶ Always make sure that the driver's seat is engaged before starting the vehicle.

⚠ WARNING Risk of injury through adjusting vehicle settings while the vehicle is in motion

You could lose control of the vehicle in the following situations:

- if you adjust the driver's seat, the head restraints, the steering wheel or the mirror while the vehicle is in motion
- if you fasten your seat belt while the vehicle is in motion

- ▶ Before starting the engine: adjust the driver's seat, the head restraints, the steering wheel or the mirror and fasten your seat belt.

⚠ WARNING Risk of becoming trapped if the seat height is adjusted carelessly

If you adjust the seat height carelessly, you or other vehicle occupants could be trapped and thereby injured.

Children in particular could accidentally press the electrical seat adjustment buttons and become trapped.

- ▶ While moving the seats, make sure that hands or other body parts do not get under the lever assembly of the seat adjustment system.

⚠ WARNING Risk of injury due to head restraints which are not fitted or are adjusted incorrectly

If head restraints are not fitted or are adjusted incorrectly, they cannot provide protection as intended.

There is an increased risk of injury in the head and neck area, e.g. in the event of an accident or when braking.

- ▶ Always drive with the head restraints fitted.
- ▶ Before driving off, make sure for every vehicle occupant that the centre of the head restraint supports the back of the head at about eye level.

Do not interchange the head restraints of the front and rear seats. Otherwise, you will not be able to set the height and inclination of the head restraints to the correct position.

Using the head restraint fore/aft adjustment, adjust the head restraint in such a way that it is as close to the back of the head as possible.

⚠ WARNING Risk of injury or death due to incorrect seat position

The seat belt does not offer the intended level of protection if you have not moved the seat backrest to an almost vertical position.

When braking or in the event of an accident, you could slide underneath the seat belt and sustain abdominal or neck injuries, for example.

- ▶ Adjust the seat properly before beginning your journey.
- ▶ Always ensure that the seat backrest is in an almost vertical position and that the shoulder section of your seat belt is routed across the centre of your shoulder.

! NOTE Damage to the seats when moving the seats back

The seats may be damaged by objects when moving the seats back.

- ▶ When moving the seats back, make sure that there are no objects in the footwell, under or behind the seats.

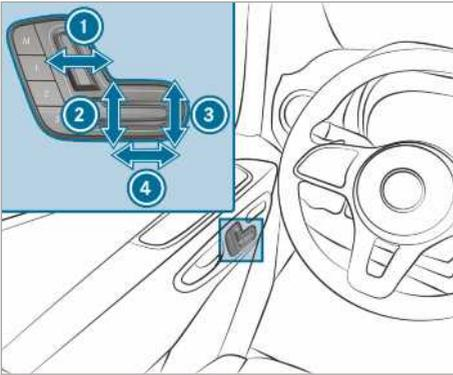

- ① Seat backrest inclination
 - ② Seat height
 - ③ Seat cushion inclination
 - ④ Seat fore-and-aft adjustment
- ▶ Save the settings with the memory function (→ page 69).

Setting 4-way lumbar support

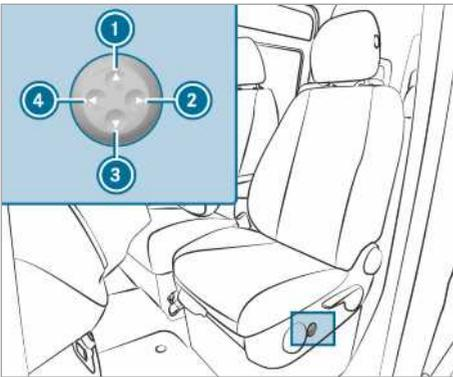

- ① Higher
 - ② Weaker
 - ③ Lower
 - ④ Stronger
- ▶ Use buttons ① to ④ to adjust the backrest curvature individually to your spine.

Operating the memory function

⚠ WARNING Risk of an accident if the memory function is used while driving

If you use the memory function on the driver's side while driving, you could lose control of the vehicle as a result of the adjustments being made.

- ▶ Only use the memory function on the driver's side when the vehicle is stationary.

⚠ WARNING Risk of entrapment when setting the seat with the memory function

When the memory function adjusts the seat, you and other vehicle occupants – particularly children – could become trapped.

- ▶ During the adjustment process of the memory function, make sure that no one has any body parts in the sweep of the seat.
- ▶ If somebody becomes trapped, immediately release the memory function position button. The adjustment process is stopped.

⚠ WARNING Risk of entrapment if the memory function is activated by children

Children could become trapped if they activate the memory function, particularly when unattended.

- ▶ Never leave children unattended in the vehicle.
- ▶ When leaving the vehicle, always take the key with you and lock the vehicle.

The memory function can be used when the ignition is switched off.

Storing seat settings

Seat settings for up to three people can be stored and called up using the memory function. You can adjust the seat and the backrest.

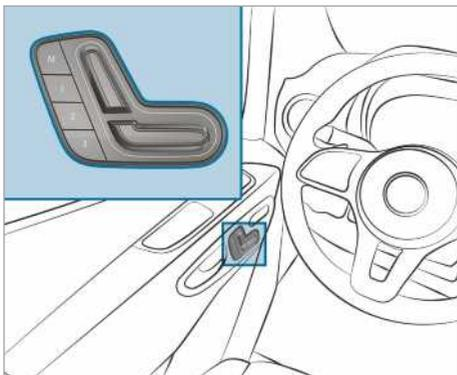

- ▶ Adjust the seat into the desired position.
- ▶ Press memory button M together with one of the preset position buttons 1, 2 or 3. An acoustic signal sounds. The settings are stored.
- ▶ **To call up:** press and hold the relevant preset position button 1, 2 or 3 until the front seat is in the stored position.

Rotating the front seats

⚠ WARNING Risk of injury or death if the driver's seat and co-driver's seat are not engaged

If the driver's- and co-driver's seats are not engaged in the direction of travel during the trip, the restraint systems cannot offer protection as intended.

- ▶ Engage the driver's- and co-driver's seat in the direction of travel before the engine is started.

⚠ WARNING Risk of injury through adjusting vehicle settings while the vehicle is in motion

You could lose control of the vehicle in the following situations:

- if you adjust the driver's seat, the head restraints, the steering wheel or the mirror while the vehicle is in motion
 - if you fasten your seat belt while the vehicle is in motion
- ▶ Before starting the engine: adjust the driver's seat, the head restraints, the

steering wheel or the mirror and fasten your seat belt.



You can rotate the driver's and front passenger seat 50 ° and 180 °. The seats engage both in and opposite to the direction of travel as well as at 50 ° to the exit.

- ▶ Ensure that the parking brake is applied and the brake lever is folded downwards as far as it will go (→ page 147).
- ▶ Adjust the steering wheel in such a way that there is sufficient free space to rotate and adjust the driver's seat (→ page 76).
- ▶ Slide the front passenger seat forward before rotating it (→ page 64).
- ▶ **To rotate the seat:** push lever ① towards the vehicle centre and rotate the seat slightly inwards. The rotation device is unlocked.
- ▶ Release lever ① again.
- ▶ Rotate the seat by around 50 ° outwards or inwards into the required position.

Folding the co-driver bench seat cushion forwards and backwards



- ▶ **To fold the seat cushion forwards:** lift the seat cushion out of the front anchorage ①.
 - ▶ Pull the seat cushion out of the rear anchorage ② and move it slightly forwards.
 - ▶ Fold the rear edge of the seat cushion upwards.
- ⓘ You can stow individual objects in the stowage space beneath the co-driver bench seat.
- ▶ **To fold the seat cushion backwards:** fold the rear edge of the seat cushion downwards.
 - ▶ Slide the seat cushion under the seat backrest into the rear anchorage ②.
 - ▶ Push the front seat cushion downwards until it engages in the front anchorage ①.

Adjusting armrests

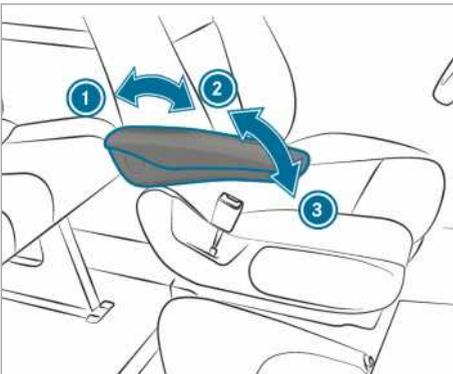

- ▶ **To set the armrest inclination:** Fold the armrest more than 45 ° upwards ②. The armrest is released.
- ▶ Fold the armrest forwards ③ as far as it will go.
- ▶ Slowly fold the armrest upwards into the required position.
- ▶ **To fold the armrest upwards:** if necessary, fold the armrest more than 90 ° upwards ①.

Folding the folding seat up or down

⚠ WARNING Risk of injury when using the folding seat due to inserted key

When the key is in the lock of the partition sliding door, it can come into contact with the person on the folding seat.

- ▶ Always remove the key from the partition sliding door before a person sits on the folding seat.

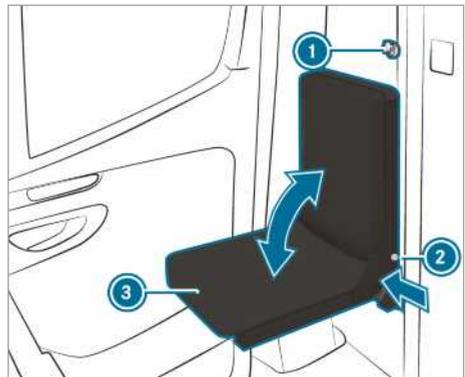

- ▶ Remove key ① from the partition sliding door.
- ▶ Press the push button on catch ② and fold seat cushion ③ up or down.
- ▶ Release push button on catch ② when seat cushion ③ reaches its end position.
- ▶ Move seat cushion ③ until it has locked. The push button on catch ② must be completely flush with the seat frame.

Example image

Installing and removing the rear bench seat

⚠ WARNING Risk of injury if rear bench seat is installed incorrectly

If you do not install the rear bench seat as described, or install an unsuitable rear bench seat, the seat belts may not provide the intended protection.

- ▶ Install the rear bench seat as described and only in the direction of travel.
- ▶ Installing the rear bench seat in the opposite direction is not permitted.
- ▶ Use only rear bench seats approved for your vehicle by Mercedes-Benz.

⚠ WARNING Risk of injury if rear bench seat is not locked in place

If the locking mechanisms on the rear bench seat legs are not correctly engaged, the rear bench seat will not be held firmly and could overturn during travel.

- ▶ Ensure that the rear bench seat is engaged before setting off. There must be no red indicator tabs visible on the release handle.
- ▶ If red indicator tabs are visible on the release handle, re-engage the rear bench seat into place.

⚠ WARNING Risk of injury when installing and removing the rear bench seat

When you install or remove the rear bench seat, body parts such as feet may become trapped when the rear bench seat is tipped.

- ▶ When installing and removing the rear bench seat, ensure that there are no body parts between the rear bench seat and the floor.

! NOTE Damage to rear bench seat rollers caused by incorrect use

The rear bench seat rollers can be damaged if the rear bench seat is used improperly or is removed incorrectly.

- ▶ As long as the rear bench seat is in the mounting shells, do not pull these in the direction of the rear doors. Roll the rear bench seat only beside the mounting shells.

- ▶ Do not roll the rear bench seat when it has been removed or use it as a means of transport.



Warning on rear bench seat with correctly installed rear bench seat shown.

Installation position of three-person rear bench seat with strut

The three-person rear bench seat is available with or without a strut. The strut is located on the rear side of the three-person rear bench seat.

The three-person rear bench seat with strut must be installed only on the third row of seats (above the rear axle).

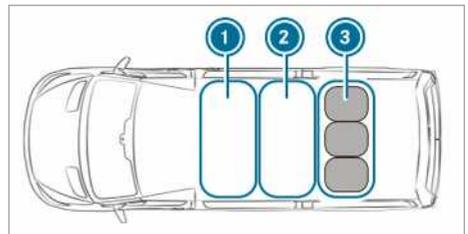

- ① First row of seats
- ② Second row of seats
- ③ Third row of seats: three-person rear bench seat with strut

- ▶ Install the three-person rear bench seat on third row of seats ③.

Removing the rear bench seat

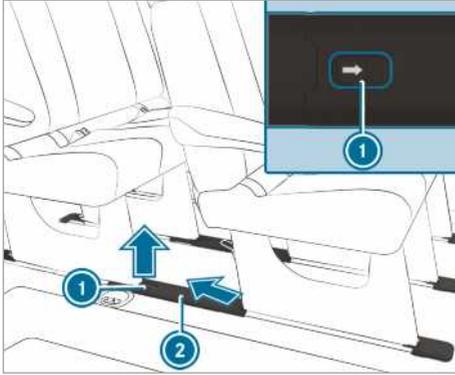

Perform these jobs carefully with the assistance of a second person.

- ▶ **To remove the covers of the mounting shells:** push clip ① in the direction of the arrow and detach cover ② by pushing to the top rear at an angle.

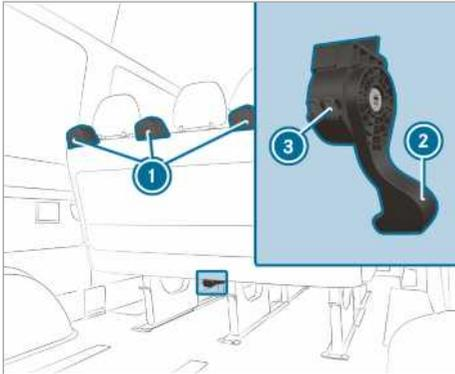

- ▶ Push release handle ② for the bench seat all the way down and hold it there while tilting the bench seat backwards slightly at the same time using the release handle and pull it slightly backwards.
- ▶ Let go of the release handle. The locks on the bench seat legs will be unlocked and red indicator tabs ③ on the housing of release handle ② will be visible.
- ▶ Hold the unlocked bench seat by grab handles ① and pull backwards slightly.

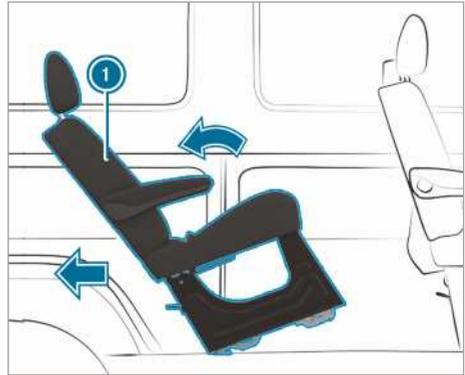

- ▶ Tilt bench seat ① backwards and pull it out of the mounting shells.

- ⓘ If the bench seat cannot be pulled out of the mounting shells, the bench seat may be wedged in the seat anchorage. This can happen if the bench seat is tilted too far backwards.

If the bench seat cannot be pulled out of the mounting shells, you can rectify this situation as follows:

- ▶ Tilt the bench seat forwards without engaging it.
- ▶ Pull the bench seat backwards again using release handle ②.
- ▶ Tilt the bench seat backwards slightly and pull it out of the mounting shells.
- ▶ To remove or store the bench seat, place it next to the mounting shells and roll it towards the rear doors.

Alternatively:

- ▶ Lift the bench seat out from the side to store it.
- ⓘ It may be necessary for the bench seats in front or behind to be removed.

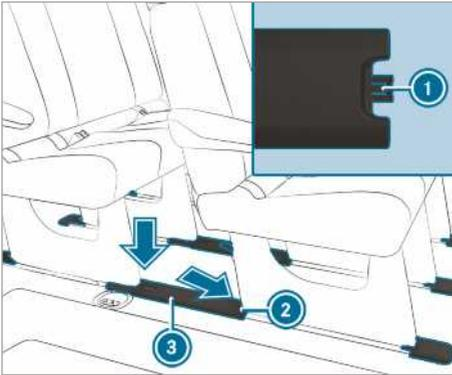

- ▶ **To attach the covers of the mounting shells:** hold cover ③ such that retaining lug ① is pointing towards rear seat anchorage ②.
- ▶ Insert cover ③ into rear seat anchorage ② by pushing it downwards at an angle and then clip it to the mounting shell.
- ▶ After removing the rear bench seat, ensure that the rear bench seat can stand securely and do not tip over when in storage.

Installing the rear bench seat

Secure engagement of the rear bench seat is guaranteed only if you keep the seat anchorages clean and free of objects.

- ① In vehicles registered as passenger vehicles, observe the maximum permitted number of seats.
- ▶ Remove the covers of the mounting shells as described under "Removing the rear bench seat".
- ▶ Ensure that there are no objects in the seat anchorages and mounting shells.
- ▶ Position the bench seat behind the installation position.
- ▶ Hold the bench seat by the grab handles and tilt it backwards.
- ▶ Roll the bench seat forwards on the level plastic carriers.
- ▶ Ensure that the rear legs of the bench seat are engaged.

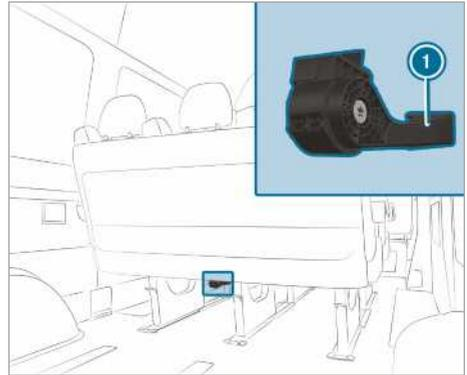

- ▶ Tilt the bench seat forwards firmly until the locks on the front legs of the bench seat engage audibly. The locks on the front legs of the bench seat will now be locked and the red indicator tabs on the housing of release handle ① should no longer be visible.
- ① If the red indicator tabs on the release handle housing are visible, the bench seat is not correctly engaged.

If the bench seat is not correctly engaged, you can rectify this situation as follows:

- ▶ Unlock the bench seat again and tilt it forwards firmly until the locks on the bench seat front legs engage audibly.
- ▶ Attach the covers of the mounting shells as described under "Removing the rear bench seat".

Adjusting the seat backrest of the rear bench seat

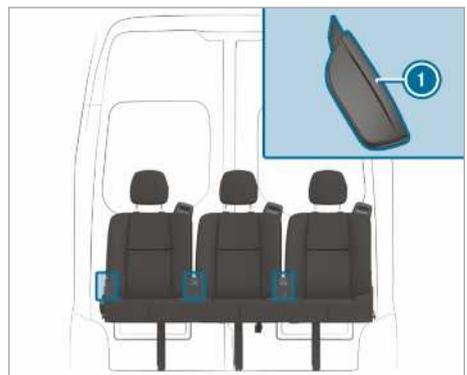

- ▶ Pull release handle ① for the seat backrest upwards and hold it in position.
- ▶ Move the seat backrest to the desired position.
- ▶ Let go of release handle ① for the seat backrest and move the seat backrest slightly. The seat backrest engages in position.

Head restraints

Adjusting the head restraints manually

⚠ WARNING Risk of injury through adjusting vehicle settings while the vehicle is in motion

You could lose control of the vehicle in the following situations:

- if you adjust the driver's seat, the head restraints, the steering wheel or the mirror while the vehicle is in motion
 - if you fasten your seat belt while the vehicle is in motion
- ▶ Before starting the engine: adjust the driver's seat, the head restraints, the steering wheel or the mirror and fasten your seat belt.

⚠ WARNING Risk of injury due to head restraints which are not fitted or are adjusted incorrectly

If head restraints are not fitted or are adjusted incorrectly, they cannot provide protection as intended.

There is an increased risk of injury in the head and neck area, e.g. in the event of an accident or when braking.

- ▶ Always drive with the head restraints fitted.
- ▶ Before driving off, make sure for every vehicle occupant that the centre of the head restraint supports the back of the head at about eye level.

Do not interchange the head restraints of the front and rear seats. Otherwise, you will not be able to set the height and inclination of the head restraints to the correct position.

Using the head restraint fore/aft adjustment, adjust the head restraint in such a way that it is as close to the back of the head as possible.

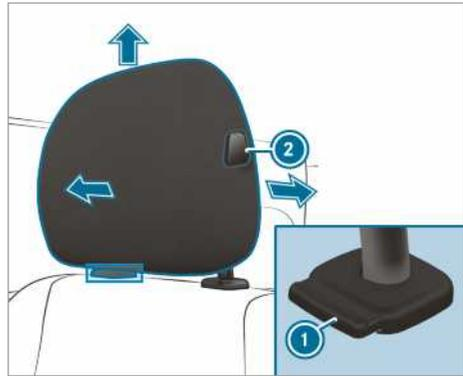

Head restraint (example of comfort head restraint on the driver's seat)

- ▶ **To raise:** pull the head restraint upwards into the required position and ensure that the head restraint is engaged. Only use the head restraint in the engaged state.
- ▶ **To lower:** push release button ① and slide the head restraint downwards into the required position and ensure that the head restraint is engaged. Only use the head restraint in the engaged state.
- ▶ **To move forwards:** push release button ② and pull the head restraint forwards until it engages in the required position.
- ▶ **To move backwards:** push release button ② and slide the head restraint backwards into the required position.

① Depending on the head restraint model, individual adjustment options may be omitted.

Switching the seat heater on and off

⚠ WARNING Risk of burns due to repeatedly switching on the seat heater

Repeatedly switching on the seat heater can cause the seat cushion and seat backrest padding to become very hot.

The health of persons with limited temperature sensitivity or a limited ability to react to high temperatures may be affected or they may even suffer burn-like injuries.

- ▶ Do not repeatedly switch on the seat heater.

To protect against overheating, the seat heating may be temporarily deactivated after it is switched on repeatedly.

- !** **NOTE** Damage to the seats caused by objects or documents when the seat heater is switched on

When the seat heater is switched on, overheating can occur due to objects or documents placed on the seats e.g. seat cushions or child seats. This could cause damage to the seat surface.

- ▶ Make sure that no objects or documents are on the seats when the seat heater is switched on.

Requirements:

- The power supply has been switched on.

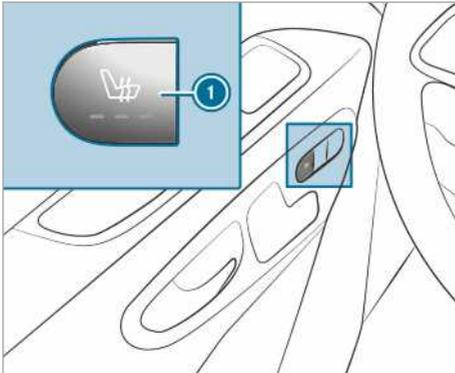

- ▶ **To switch on:** press button ①. All indicator lamps on the button light up.
 - ▶ **To lower the level:** press button ① until the required heating level is reached. Depending on the heating level, one to three indicator lamps light up.
 - ▶ **To switch off:** press button ① until all indicator lamps are off.
- ① The seat heater automatically switches back out of the three heating levels after 8, 10 and 20 minutes until the seat heater switches off.

Adjusting the steering wheel

- !** **WARNING** Risk of injury through adjusting vehicle settings while the vehicle is in motion

You could lose control of the vehicle in the following situations:

- if you adjust the driver's seat, the head restraints, the steering wheel or the mirror while the vehicle is in motion
- if you fasten your seat belt while the vehicle is in motion

- ▶ Before starting the engine: adjust the driver's seat, the head restraints, the steering wheel or the mirror and fasten your seat belt.

- !** **WARNING** Risk of entrapment for children when adjusting the steering wheel

Children could injure themselves if they adjust the steering wheel.

- ▶ Never leave children unattended in the vehicle.
- ▶ When leaving the vehicle, always take the key with you and lock the vehicle.

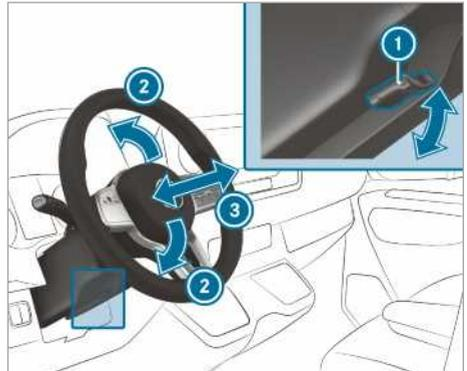

- ① Lever
- ② Steering column height
- ③ Steering column fore-and-aft adjustment

- ▶ **To adjust the steering wheel:** swing lever ① down as far as it will go. The steering wheel is unlocked.
- ▶ Move the steering wheel to the desired position.

- ▶ Pull lever ❶ up as far as it will go.
The steering wheel is locked.

Stowage areas

Notes on loading guidelines

▲ DANGER Risk of poisoning from exhaust gases

Combustion engines emit poisonous exhaust gases, such as carbon monoxide. Exhaust gases can enter the vehicle interior if the rear-end door is open when the engine is running, especially if the vehicle is in motion.

- ▶ Always switch off the engine before opening the rear-end door.
- ▶ Never drive with the rear-end door open.

▲ WARNING Risk of injury from unsecured objects in the vehicle

When objects are unsecured or inadequately secured, they can slip, tip over or be thrown about, striking vehicle occupants.

This also applies to:

- luggage or loads
- seats which have been removed and are being transported in the vehicle in an exceptional case

There is a risk of injury, particularly in the event of braking manoeuvres or abrupt changes in direction.

- ▶ Always stow objects in such a way that they cannot be tossed about.
- ▶ Before travelling, secure objects, luggage or load to prevent them slipping or tipping over.
- ▶ When a seat is removed, keep it preferably outside the vehicle.

▲ WARNING Risk of injury from inadequate stowage of objects

If you do not adequately stow objects in the vehicle interior, they could slip or be tossed around and thereby strike vehicle occupants. In addition, cup holders, open stowage spaces and mobile phone brackets cannot always restrain the objects they contain in the event of an accident.

There is a risk of injury, particularly in the event of sudden braking or a sudden change in direction.

- ▶ Always stow objects in such a way that they cannot be tossed around in these or similar situations.
- ▶ Always make sure that objects do not project from stowage spaces, luggage nets or stowage nets.
- ▶ Close all sealable stowage spaces before you start your journey.
- ▶ Stow and secure objects that are heavy, hard, pointed, sharp-edged, fragile or too large in the load compartment.

▲ WARNING Risk of burning from the tailpipe or tailpipe trim

The tailpipe and tailpipe trim can become very hot. If you come into contact with these car parts, you could burn yourself.

- ▶ Always be particularly careful when in the vicinity of the tailpipe and tailpipe trims and supervise children very closely when in this area.
- ▶ Before any contact, allow the car parts to cool down.

If you are using a roof rack, please note the maximum roof load and the maximum load capacity of the roof rack.

You will find information about the maximum roof load in the "Technical data" chapter and information about roof racks in the "Carrier systems" section .

Camera-based driving systems and the sensor functions of the inside rearview mirror may be impaired if you are transporting a load on the roof and it protrudes more than 40 cm over the edge of the roof. Therefore, make sure that the load does not overhang by more than 40 cm.

The handling characteristics of your vehicle are dependent on the load distribution. Therefore, please observe the following notes when loading:

- when transporting a load, never exceed the permissible gross mass or the permissible axle loads for the vehicle (including occupants).
- the load must not protrude above the upper edge of the seat backrests.

- if possible, always transport the load in the load compartment.
- fasten the load to the tie-down eyes and spread the load as evenly as possible.
- use tie-down eyes and fastening components which are suitable for the weight and size of the load.

Overview of the front stowage compartments

Overview of the front stowage compartments

Observe the notes on loading the vehicle (→ page 77).

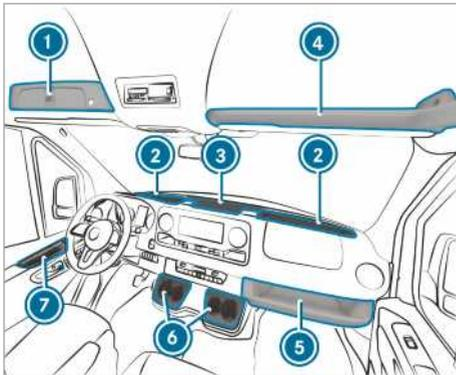

- ① Lockable compartment above windscreen (→ page 78)
- ② Windscreen stowage compartment with two cup holders / ashtray storage space
Stowage compartment with cover, depending on specification (→ page 78)
- ③ Centre console stowage compartment with USB connection, charging interface, NFC interface and 12-V socket
- ④ Stowage compartment above windscreen (subject to a maximum load of 2.5 kg)
- ⑤ Front passenger stowage compartment (subject to a maximum load of 5 kg)
- ⑥ Cup holder
- ⑦ Stowage compartment in the doors

Opening and closing the centre console/windscreen stowage compartment

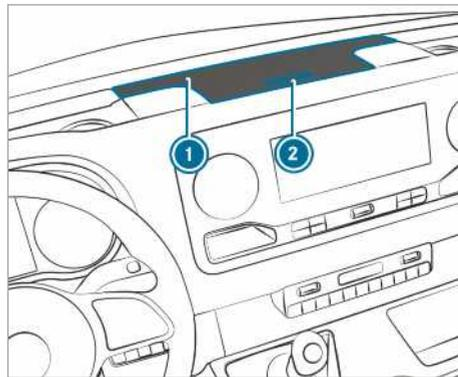

Stowage compartment cover (example: centre console)

- ▶ **To open:** press button ② on stowage compartment ①.
The cover folds upwards.

- ▶ **To close:** fold the cover downwards.

ⓘ The windscreen stowage compartments have a cover, depending on the specification.

Opening and closing the lockable compartment above the windscreen

You can lock and unlock the stowage compartment with the emergency key (→ page 46).

To open

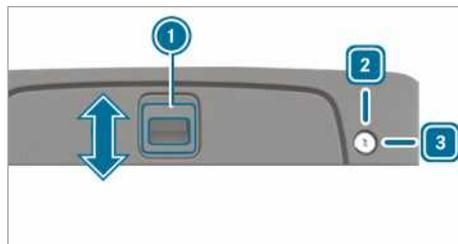

- ▶ **To unlock:** turn the emergency key clockwise to position ③.
- ▶ Slide handle ① upwards in the direction of the arrow.
- ▶ Swivel the cover upwards.

To close

- ▶ Fold the cover downwards and slide handle ① downwards in the direction of the arrow.

- ▶ **To lock:** turn the emergency key anti-clockwise to position **2**.

Opening the spectacles compartment

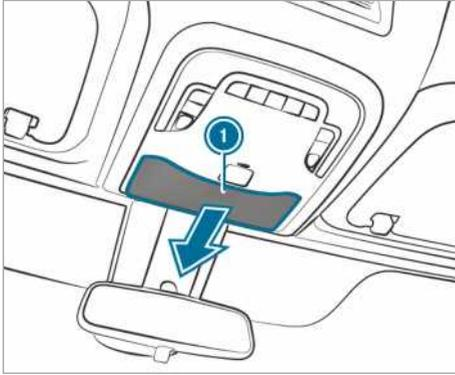

- ▶ Press button **1**.

Using the stowage box

⚠ WARNING Risk of injury due to incorrectly stowed or open stowage box

If you stow the stowage box in the vehicle interior incorrectly, it can slide or be thrown around and hit vehicle occupants. In addition, open stowage spaces may not, in the event of an accident, hold back all the objects they contain.

There is a risk of injury, particularly in the event of braking manoeuvres or abrupt changes in direction.

- ▶ Secure the stowage box with the seat belt.
- ▶ Before driving off, close the cover of the stowage box.
- ▶ Stow and secure objects that are heavy, hard, pointed, sharp-edged, fragile or too large in the load compartment.

Attaching the stowage box

The stowage box is stowed beneath the front passenger bench seat.

Use the stowage box for the following:

- to store documents
- to stow a mobile phone or small objects
- as a writing support

- ▶ Fold the seat cushion of the front passenger bench seat forwards (→ page 71).

- ▶ Remove the stowage box from the stowage compartment.
- ▶ Fold back the seat cushion of the front passenger bench seat (→ page 71).

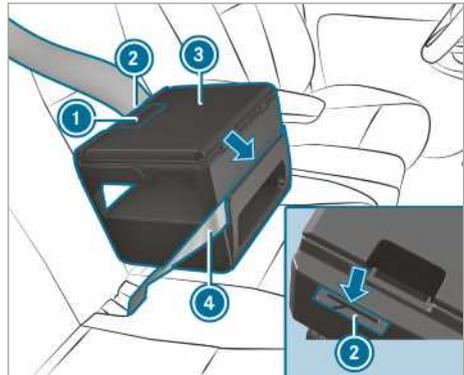

- ▶ Place stowage box **3** onto the seat.
- ▶ Push stowage box **3** lightly downwards into the seat cushion, and slide it backwards against the backrest.
- ▶ Ensure that the anchoring rib on the underside of the stowage box is attached between the seat cushion and backrest.
- ▶ Thread seat belt **4** through the slot on the front of stowage box **3**.
- ▶ Thread seat belt **4** through slot **2** on the rear of the stowage box, tighten it and fasten it.
- ▶ Check that the stowage box is seated firmly.

Opening and closing the stowage box

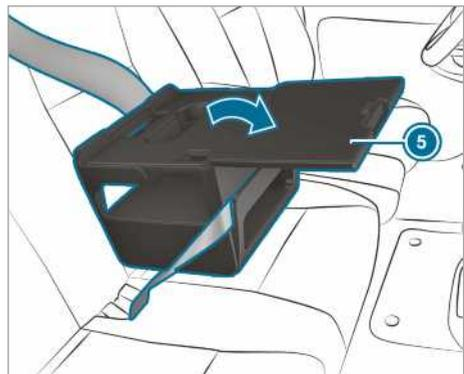

▶ **To open:** pull handle ① and open cover ⑤ in the direction of the arrow.

▶ Stowing objects.

① Information about further accessories, such as tablet holders, is available from a Mercedes-Benz service centre.

① While driving, keep the cover of the stowage box closed.

▶ **To close:** fold cover ⑤ back and press it closed so that handle ① engages.

Stowing the stowage box

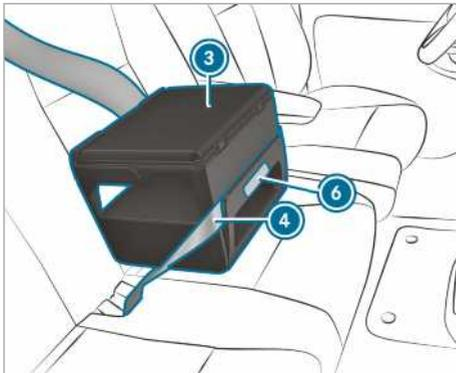

- ▶ Loosen the seat belt ④.
- ▶ Hold stowage box ③ in the area indicated ⑥ and pull it forwards in a straight line. The anchoring rib will release from the gap between the seat cushion and backrest.
- ▶ Take stowage box ③ off the seat.
- ▶ Fold the seat cushion of the front passenger bench seat forwards (→ page 71).
- ▶ Place stowage box ③ in the stowage compartment.
- ▶ Fold back the seat cushion of the front passenger bench seat (→ page 71).

Bottle holder

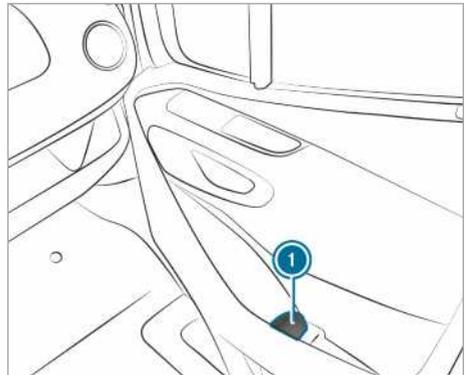

① Bottle holder in the front doors (example: co-driver's door)

Cup holder

Opening the cup holder in the rear

⚠ WARNING Risk of injury when getting out, due to extended cupholder

If the cupholder in the rear has been extended when you are getting out, you may bump into it.

▶ Before getting out, slide the cupholder back under the rear bench seat.

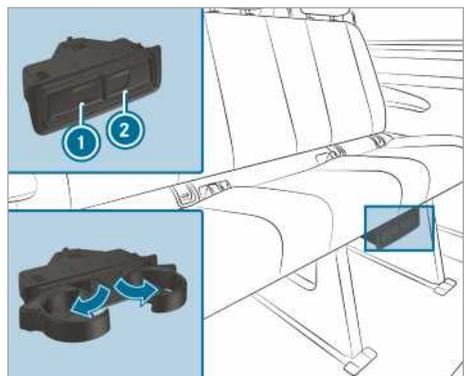

▶ **To open:** press the cup holder ① or ②.

▶ Fold out the cup holder.

▶ **To close:** slide the cup holder ① or ② back in until it engages.

Ashtray and cigarette lighter

Using ashtrays

While driving

- ▶ Place the closed ashtray in a cup holder in the windscreen stowage compartments while driving.
- ▶ Check that the ashtray is seated securely.
- ⓘ Do not place the ashtray in the centre console cup holders. It cannot sit securely here.

To open

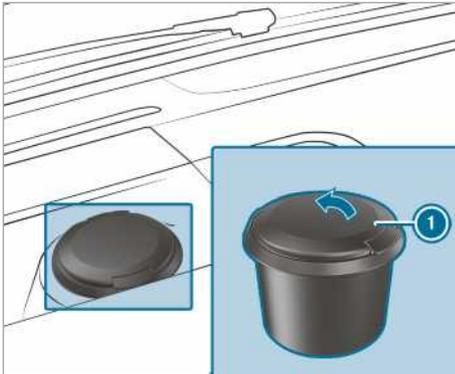

- ▶ Fold the cover ① upwards.

Using the cigarette lighter in the centre console

⚠ WARNING - Risk of fire and injury from the hot cigarette lighter

You can burn yourself if you touch the hot heating element or the socket of the cigarette lighter.

In addition, flammable materials may ignite if:

- you drop the hot cigarette lighter
- a child holds the hot cigarette lighter to objects, for example
 - ▶ Always hold the cigarette lighter by the knob.
 - ▶ Always make sure that the cigarette lighter is out of reach of children.
 - ▶ Never leave children unattended in the vehicle.

Requirements:

- the ignition is switched on

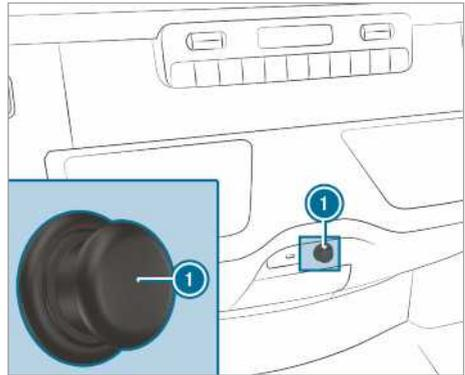

- ▶ Press in cigarette lighter ①. The cigarette lighter will pop out when the heating element is red-hot.

Sockets

Using 12 V sockets in the centre console

Requirements:

- Only devices with a maximum power consumption of 180 W (15 A) may be connected.

12 V socket in stowage compartment

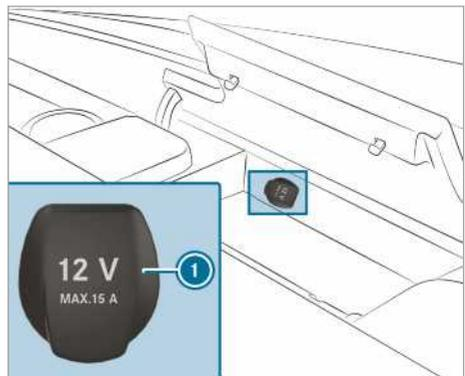

- ▶ Open the lid of the stowage compartment in the centre console (→ page 78).
- ▶ Fold up cover ① of the socket.
- ▶ Insert the plug of the device.

12 V socket in lower control panel

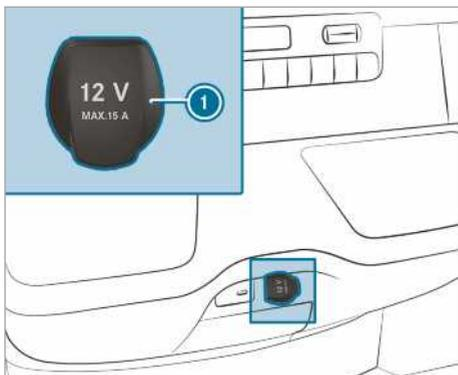

- ▶ Lift up cover ① of the socket.
- ▶ Insert the plug of the device.

Using 12 V socket on the driver's seat



- ▶ Fold up cover ① of the socket.
- ▶ Insert the plug of the device.

Notes on the 230 V socket

- 1** **NOTE** Damage to the auxiliary battery due to full discharge

The auxiliary battery may become damaged if a device with too high a power output is connected when you leave the vehicle, or the auxiliary battery's charge level is low.

- ▶ Only connect devices up to a maximum of 150 W.

- ▶ Do not leave devices connected for longer than four hours.

With 150 W, the 230 V socket provides a high power output which enables mobile phones to charge quickly and to connect battery chargers for tools.

Vehicles with an auxiliary battery have a run-on function. If you leave the vehicle, you can charge devices over a period of four hours.

Using the 230 V socket in the centre console

- ⚠ DANGER** Risk of fatal injury due to damaged connecting cables or sockets

When a suitable device is connected, the 230 V power socket will be carrying a high voltage. You could receive an electric shock if the connecting cable or the 230 V power socket is pulled out of the trim or is damaged or wet.

- ▶ Use only connecting cables that are dry and free of damage.
- ▶ When the ignition is switched off, make sure that the 230 V power socket is dry.
- ▶ Immediately have the 230 V power socket checked or replaced at a qualified specialised workshop if it is damaged or has been pulled out of the trim.
- ▶ Never plug the connecting cable into a 230 V power socket that is damaged or has been pulled out of the trim.

- ⚠ DANGER** Risk of fatal injury due to incorrect handling of the socket

You could receive an electric shock:

- if you reach into the socket.
- if you insert unsuitable devices or objects into the socket.
- ▶ Do not reach into the socket.
- ▶ Only connect suitable devices to the socket.

- ⚠ DANGER** Risk of fatal injuries from electric shock

You could get an electric shock if you clean the 230 V socket with a wet cloth.

There is a risk of fatal injury.

Omit the area around the 230 V socket when cleaning.

Requirements:

- Only connect devices with a suitable plug which conforms to the standards specific to the country you are in.
- Only connect devices up to a maximum of 150 W.
- Do not use multiple socket outlets.

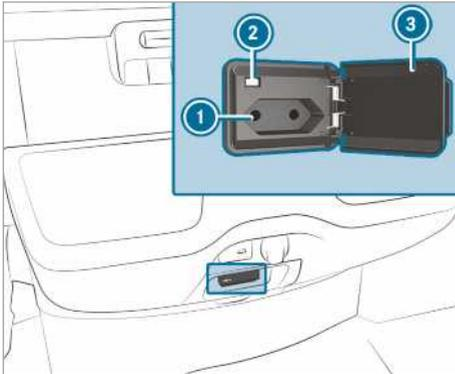

- ▶ Open flap ③.
 - ▶ Insert the plug of the device into 230 V socket ①.
- When the on-board electrical system voltage is sufficient, indicator lamp ② lights up.

If you will not be using the 230 V power socket, keep the flap closed.

Using sockets in the load compartment

Requirements:

- Only devices with a maximum power consumption of 180 W (15 A) may be connected.

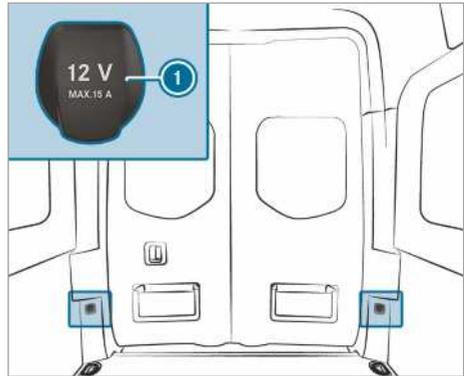

- ▶ Fold up cover ① of the socket.
- ▶ Insert the plug of the device.

Charging a mobile phone using the USB socket in the rear

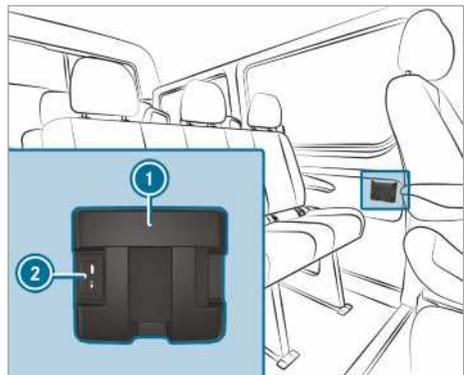

- ▶ Place the mobile phone in stowage compartment ① and connect it to USB socket ② to charge.

Wirelessly charging the mobile phone and coupling with the exterior aerial

Notes on wirelessly charging the mobile phone

▲ WARNING Risk of injury from inadequate stowage of objects

If you do not adequately stow objects in the vehicle interior, they could slip or be tossed around and thereby strike vehicle occupants. In addition, cup holders, open stowage

spaces and mobile phone brackets cannot always restrain the objects they contain in the event of an accident.

There is a risk of injury, particularly in the event of sudden braking or a sudden change in direction.

- ▶ Always stow objects in such a way that they cannot be tossed around in these or similar situations.
- ▶ Always make sure that objects do not project from stowage spaces, luggage nets or stowage nets.
- ▶ Close all sealable stowage spaces before you start your journey.
- ▶ Stow and secure objects that are heavy, hard, pointed, sharp-edged, fragile or too large in the load compartment.

Comply with the instructions for loading the vehicle.

⚠ WARNING Risk of fire from placing objects in the mobile phone stowage compartment

If you place objects in the mobile phone stowage compartment, they may heat up excessively and even catch fire.

- ▶ Do not place additional objects, especially those made of metal, in the mobile phone stowage compartment.

! NOTE Damage to objects caused by placing them in the mobile phone stowage compartment

If objects are placed in the mobile phone stowage compartment, they may be damaged by electromagnetic fields.

- ▶ Do not place credit cards, storage media or other objects sensitive to electromagnetic fields in the mobile phone stowage compartment.

! NOTE Damage to the mobile phone stowage compartment caused by liquids

If liquids enter the mobile phone stowage compartment, the compartment may be damaged.

- ▶ Ensure that no liquids enter the mobile phone stowage compartment.

Observe the following notes on wireless charging:

- The charging function is only available when the ignition is switched on.
- In some cases, it may not be possible to charge small mobile phones at every position of the mobile phone receptacle.
- It may not be possible to charge large mobile phones that do not rest in the mobile phone receptacle.
- The mobile phone can warm up during the charging process. This depends on the applications (apps) currently running.
- For more efficient charging, the protective case should be removed from the mobile phone. Protective cases designed for wireless charging are an exception.
- When charging, the mat should be used if possible.

Charging the mobile phone in the front wirelessly

Requirements:

- The mobile phone must be suitable for wireless charging. A list of compatible mobile phones can be found at:

<http://www.mercedes-benz.com/connect>

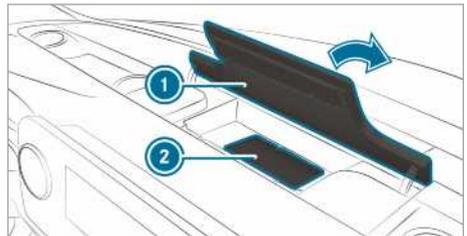

- ▶ Open the flap of stowage compartment ① above the media display.
 - ▶ Place the mobile phone as centrally as possible with the display facing upwards on the marked surface of mat ②.
- When the charging symbol is shown in the multimedia system, the mobile phone is being charged.
- Malfunctions during charging are shown in the multimedia system display.
- ⓘ The mat can be removed for cleaning, e.g. with clean, lukewarm water.

Fitting or removing the floor mats

⚠ WARNING Risk of accident due to objects in the driver's footwell

Objects in the driver's footwell may impede pedal travel or block a depressed pedal.

This jeopardises the operating and road safety of the vehicle.

- ▶ Stow all objects in the vehicle securely so that they cannot get into the driver's footwell.
- ▶ Always fit the floor mats securely and as prescribed in order to ensure that there is always sufficient room for the pedals.
- ▶ Do not use loose floor mats and do not place floor mats on top of one another.

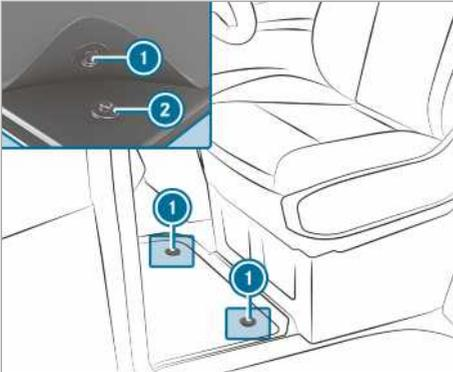

▶ **To install:** Press the pushbuttons ① onto the holders ②.

▶ **To remove:** Pull the floor mats off the holders ②.

Exterior lighting

Notes on changing the lights when driving abroad

Vehicles with halogen or static LED headlamps: Changing the headlamps is not necessary. The legal requirements will also be fulfilled in countries with left- and right-hand traffic.

Information about lighting systems and your responsibility

The vehicle's various lighting systems are only aids. The vehicle driver is responsible for adjusting the vehicle's lighting to the prevailing light, visibility, statutory conditions and traffic conditions.

Light switch

Operating the light switch

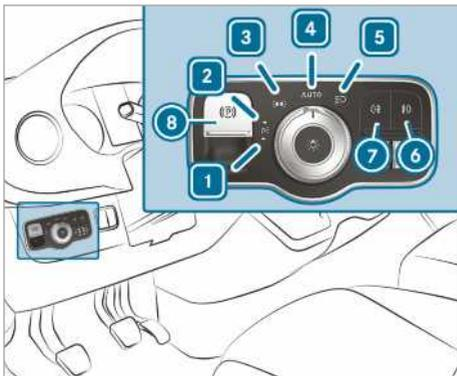

- ▶ **1** Activates or deactivates left-hand parking lights.
- ▶ **2** Activates or deactivates right-hand parking lights.
- ▶ **3** Activates or deactivates standing light and licence plate and instrument lighting.
- ▶ **4** **AUTO** Activates or deactivates automatic headlamps/daytime running lights (preferred light switch position).
- ▶ **5** Activates or deactivates dipped beam / main beam.
- ▶ **6** Activates or deactivates fog light.
- ▶ **7** Activates or deactivates rear fog lights.

▶ Applies and releases the electric parking brake(→ page 148)

- ▶ **i** If you hear a warning tone when exiting the vehicle, the light may still be on.
- ▶ **i** If you turn on the parking light, there will be a reduced standing light on the selected vehicle side.
The turn signal indicator, the main beam and the headlamp flasher are operated with the combination switch (→ page 87).

! **NOTE** Battery discharging by operating the standing lights

Operating the standing lights over a period of hours puts a strain on the battery.

▶ Where possible, switch on the right or left parking light.

In the event of heavy battery discharge, the standing or parking light is automatically switched off for the benefit of the next vehicle start.

Automatic driving lights function

! **WARNING** Risk of accident when the dipped beam is switched off in poor visibility

When the light switch is set to **AUTO**, the dipped beam may not be switched on automatically if there is fog, snow or other causes of poor visibility such as spray.

▶ In such cases, turn the light switch to .

The automatic dipped beam is only an aid. Responsibility for vehicle lighting rests with you. Turn the light switch from **AUTO** to immediately in the event of fog, snow or spray. Otherwise, the dipped beam is temporarily interrupted.

Switching the automatic dipped beam on:

- Turn the light switch to the **AUTO** position. Switch the voltage supply on: the standing light automatically switches on or off depending on the surrounding brightness.

The daytime running lights are switched on when the engine is running. The standing light and the dipped beam also switch on or off depending on the surrounding brightness.

When the dipped beam is switched on, the indicator lamp on the instrument cluster switches on.

Switching fog light and rear fog light on or off

Requirements:

- The light switch is in position  or **AUTO**.
- The voltage supply or engine is on.

▶ **Switching the fog light on or off:** press the  button.

▶ **Switching the rear fog light on or off:** press the  button.

Comply with the country-specific regulations for using the rear fog light.

Regulating headlamp range

Requirements:

- the engine is running.

You can use the headlamp range controller to adjust the light cone of the headlamps to the vehicle's load condition. As the seats are occupied or the load compartment is loaded or unloaded, the light cone changes. This can cause visibility conditions to deteriorate and you could dazzle oncoming traffic.

 In vehicles with LED headlamps, the headlamp range is adjusted automatically.

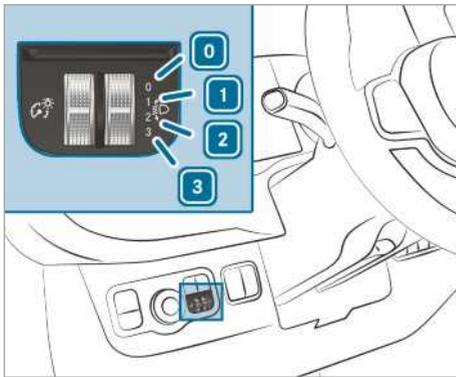

-  Driver's and front passenger seat occupied
-  Driver's seat, front passenger seat and rear seats occupied
-  Driver's seat, front passenger seat and rear seats occupied, load compartment or loading area loaded
-  Driver's seat and front passenger seat occupied and using the maximum permitted rear axle load

- ▶ Turn the headlamp range controller to the corresponding position. The road illumination should be 40 m to 100 m and the dipped beam must not dazzle oncoming traffic.
- ▶ If the vehicle is unloaded, select the  position.

Operating the combination light switch

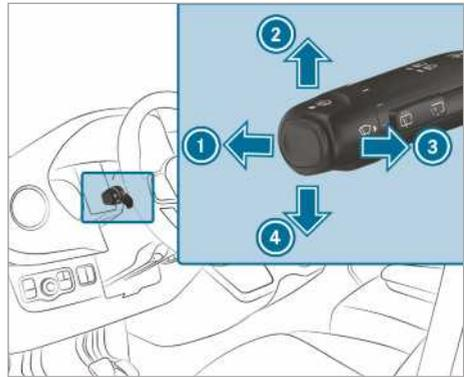

-  High beam
-  Right indicator
-  Headlamp flasher
-  Left indicator

- ▶ **To indicate:** push the combination switch in the required direction  or  until it engages. In the case of larger steering movements, the combination switch automatically switches back.
- ▶ **To indicate briefly:** tap the combination switch briefly in the required direction  or . The corresponding turn signal light flashes three times.
- ▶ **To switch on the high beam:** switch on the dipped beam (→ page 86).
- ▶ Press the combination switch forwards . The indicator lamp  on the instrument cluster will light up. The combination switch will return to its starting position.
-  The high beam switches to position **AUTO** only in darkness and when the engine is running.
- ▶ **To switch off the main beam:** push the combination switch  forwards or briefly pull it in the direction of the arrow  (the

headlamp flasher switches the main beam off).

The indicator lamp  on the instrument cluster will go out. The combination switch will return to its starting position.

i Vehicles with Highbeam Assist: when Highbeam Assist is active, it controls the activation and deactivation of the high beam (→ page 88).

▶ **To activate the headlamp flasher:** switch on the power supply or ignition.

▶ Briefly pull the combination switch in the direction of the arrow .

Switching hazard warning lights on or off

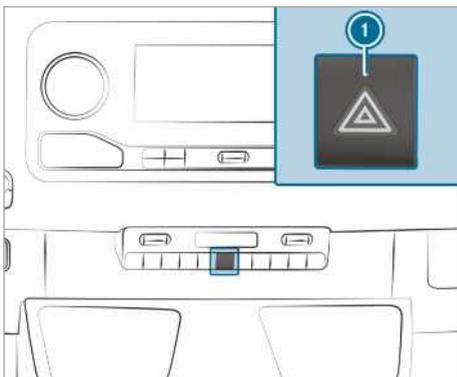

▶ **To switch on and off:** press the  button.

If you operate a turn signal indicator while the hazard warning lights are switched on, only the turn signal indicator on the relevant side of the vehicle lights up.

The hazard warning lights will switch on automatically if:

- the airbag is deployed.
- the vehicle is sharply braked from a speed of more than 70 km/h to a standstill.

If the hazard warning lights have automatically switched on, press the hazard warning lamp switch  to switch them off.

The hazard light lamps will automatically switch off when the vehicle regains a speed of more than 70 km/h after full brake application.

i The hazard warning lights work even when the ignition is switched off.

Cornering light function

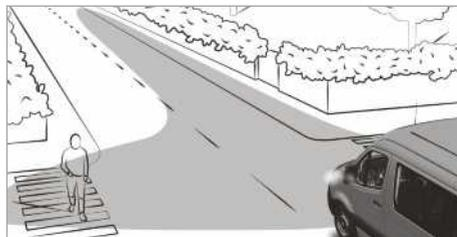

Cornering light improves the illumination of the carriageway over a wide angle in the turning direction, enabling better visibility in tight bends, for example.

The function is active under the following conditions:

- The speed is less than 40 km/h and the indicator has been switched on or the steering wheel is turned.
- The speed is between 40 km/h and 70 km/h and the steering wheel is turned.

The cornering light may still light up for a short time but is switched off automatically after a maximum of three minutes.

i When reverse gear is engaged, the lighting switches to the opposite side.

Highbeam Assist

Adaptive Highbeam Assist function

⚠ WARNING Risk of accident despite Adaptive Highbeam Assist

Adaptive Highbeam Assist does not recognise the following road users:

- Road users without lights, e.g. pedestrians
- Road users with poor lighting, e.g. cyclists
- Road users whose lighting is obstructed, e.g. by a barrier

On very rare occasions, Adaptive Highbeam Assist may fail to recognise other road users with their own lighting, or may recognise them too late.

In this, or in similar situations, the automatic main beam will not be deactivated or will be activated despite the presence of other road users.

- ▶ Always observe the traffic carefully and switch off the main beam in good time.

The Adaptive Highbeam Assist automatically switches between the following settings:

- Dipped beam
- High beam

The system detects that vehicle lights are approaching in the opposite direction or driving ahead of the vehicle.

At speeds greater than 30 km/h, a change is made to the following setting:

- If no other road users are detected, the high beam switches on automatically.

At speeds less than 25 km/h or if there is sufficient road lighting, a change is made to the following setting:

- The high beam automatically switches off.

System limitations

Adaptive Highbeam Assist cannot take the road, weather or traffic conditions into consideration.

The detection of obstacles can be restricted if:

- visibility is impaired, e.g. in fog, heavy rain or snow
- the sensors are dirty or covered

Adaptive Highbeam Assist is only an aid. You are responsible for ensuring correct vehicle lighting in accordance with the prevailing light, visibility and traffic conditions.

The system's optical sensor is located behind the windscreen near the overhead control panel.

Switching Highbeam Assist on or off

- ▶ **To switch on:** turn the light switch to position **AUTO**.
- ▶ Switch the highbeam on using the combination switch.
If the highbeam is automatically switched on in darkness, the indicator lamp  on the multifunction display lights up.
- ▶ **To switch off:** switch off the highbeam using the combination switch.

Setting the exterior lighting switch-off delay time

Requirements:

- The light switch is in position **AUTO**.

Multimedia system:

- ▶  ▶ Settings ▶ Lights
- ▶▶ Ext. light. del. shut-off
- ▶▶▶ Setting a switch-off delay time.

When the vehicle engine is switched off, the exterior lighting will be activated for the set time.

Activating and deactivating the surround lighting

Multimedia system:

- ▶  ▶ Settings ▶ Lights
- ▶▶ Surround lighting
- ▶▶▶ Activate or deactivate the function.

The exterior lighting remains on for 40 seconds after the vehicle is unlocked. When you start the vehicle, the surround lighting will be deactivated and the automatic driving lights activated.

Activating/deactivating the rotating beacon

▲ WARNING Risk of accident due to automatic deactivation of the rotating beacon

When the engine is switched off, the rotating beacon will deactivate automatically as soon as the on-board electrical system voltage drops to a critical level.

Other road users will then no longer be warned of the area of danger.

- ▶ Use additional safety precautions, such as a warning triangle, to warn other road users.

Switching on the rotating beacon

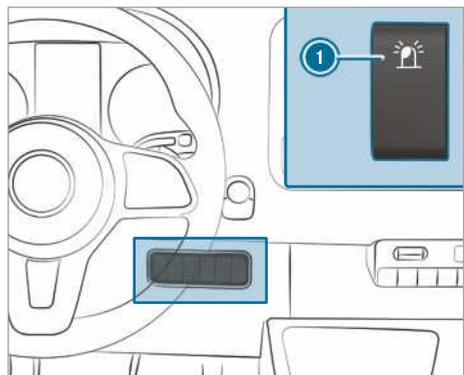

- ▶ Press the upper section of the switch ①. The switch will remain in the tilting position. The indicator lamp on the switch will light up.

Switching off the rotating beacon

- ▶ Press the bottom section of the switch ①. The switch will remain in the centre position. The indicator lamp on the switch will no longer be lit up.

Adjusting the interior lighting

Adjusting the front interior lighting

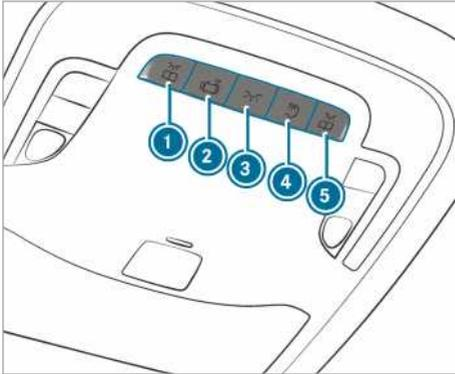

Variant 1

- ▶ ①  Switches front left reading lamp on or off
- ▶ ②  Switches the automatic interior lighting control on or off
- ▶ ③  Switches front interior lighting on or off
- ▶ ④  Switches rear/load compartment lighting on or off
- ▶ ⑤  Switches front right reading lamp on or off

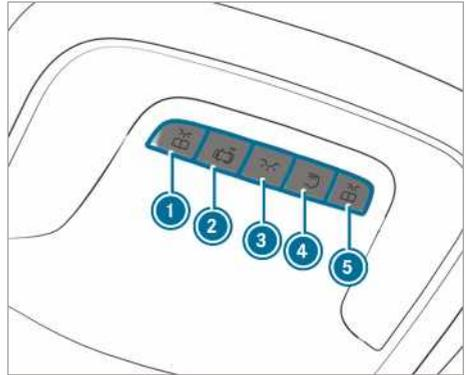

Variant 2

- ▶ ①  Switches front left reading lamp on or off
- ▶ ②  Switches the automatic interior lighting control on or off
- ▶ ③  Switches front interior lighting on or off
- ▶ ④  Switches rear/load compartment lighting on or off
- ▶ ⑤  Switches front right reading lamp on or off

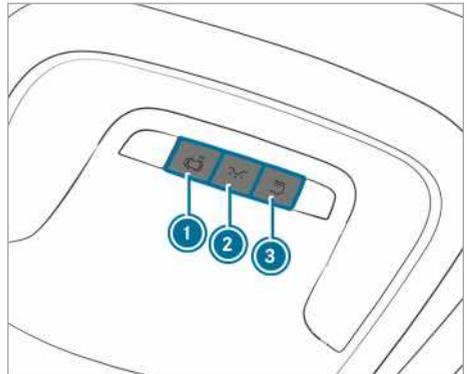

Variant 3

- ▶ ①  Switches the automatic interior lighting control on or off
- ▶ ②  Switches front interior lighting on or off
- ▶ ③  Switches rear/load compartment lighting on or off

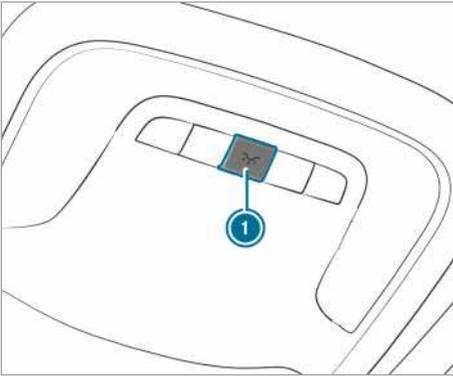

Variant 4

- ▶ ①  Activates/deactivates interior lighting

Rear interior lighting

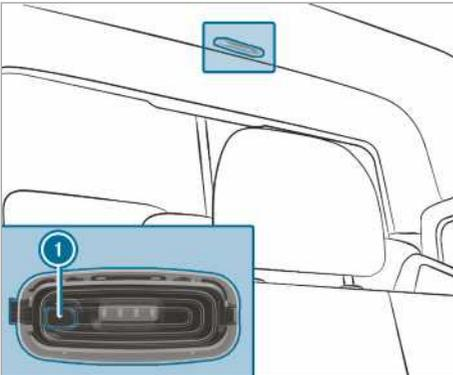

- ▶ ① Switches rear/load compartment lighting on or off

Motion detector

⚠ WARNING Risk of injury by laser beam from motion detector

The motion detector transmits invisible radiation from LEDs (light-emitting diodes).

These LEDs are classified under the 1M laser class and can cause retina damage in the following situations:

- If you look directly into the unfiltered laser beam from the motion detector for an extended period
- If you look directly into the laser beam of the motion detector with optical instruments such as spectacles or a magnifying glass.

▶ Never look directly into the laser beam.

The motion detector is located in the cargo compartment behind the partition, in the middle of the roof.

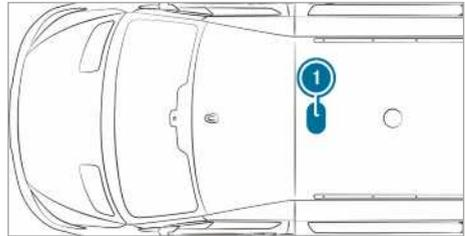

① Position of motion detector

If the vehicle is equipped with a motion detector, the cargo compartment lighting is also activated via the motion detector.

If the motion detector detects movement in the cargo compartment while the vehicle is stationary, the cargo compartment lighting switches on for approximately two minutes.

The cargo compartment lighting can be switched on via the motion detector if:

- the vehicle is stationary, the parking brake is applied and the brake pedal is not being depressed.
- **Vehicles with automatic transmission:** the selector lever is in position **P** and you are not depressing the brake pedal.
- the vehicle has not been locked from the outside using the key.

If no change to the vehicle, such as a door opening, is detected over several hours, the motion detector will automatically switch off. This prevents the battery from discharging.

Switching interior lighting delay time on/off

Multimedia system:

→ [Home] >> Settings >> Lights

>> Int. light. del. shut-off

▶ Switching the lighting delay time on and off.

Changing bulbs

Instructions for changing bulbs

⚠ WARNING Risk of burns from hot component parts whilst replacing a bulb

Bulbs, lamps and plug connectors can become very hot during operation.

When replacing a bulb, you could burn yourself on these component parts.

▶ Allow the component parts to cool down before replacing the bulbs.

When you are replacing the light bulb, observe the following:

- Do not use any bulb that has been dropped or has scratches on its glass tube. Otherwise, the bulb may explode.
- The bulb may explode if it is hot or if you touch, drop or scratch it.
- Stains on the glass tube reduce the bulb's service life. Do not touch the glass tube with your bare hands. If necessary, clean the glass tube with alcohol or spirits in a cold state and wipe it down with a lint-free cloth.
- Protect bulbs from humidity and do not bring them into contact with liquids.

Always ensure the bulbs are firmly secured.

If your vehicle is equipped with LED lamps, you can check this as follows: the light cone will move from top to bottom and back again when the engine starts. For this to work, the dipped beam needs to have been switched on before the engine is started.

Bulbs and lights are a major part of vehicle safety. Therefore, ensure that they are always working. Have the headlamp setting checked regularly.

- Before changing the lamps, switch off the vehicle's lighting system. This will prevent a short circuit.
- Use bulbs only in closed lights that have been designed for them.

- Use only spare bulbs of the same type and with the correct voltage.

If the new bulb also does not light up, consult a qualified specialist workshop.

Replacing front light bulbs (vehicles with halogen headlamps)

Overview of front bulb types

You can change the following bulbs.

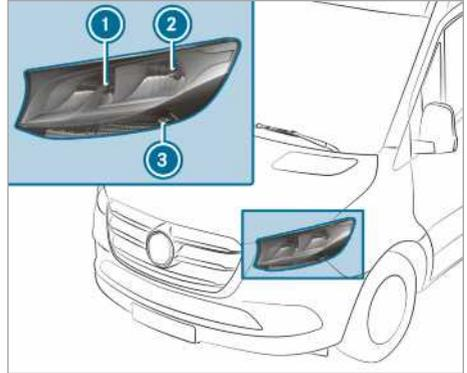

Halogen headlamps

- ① Main beam/daytime running lights: H15 55 W/15 W
- ② Dipped beam/perimeter light: H7 55 W/W 5 W
- ③ Indicators: PY 21 W

Changing the halogen headlamps

Requirements:

- **Dipped beam:** light bulb type H7 55 W
- **High beam/daytime running lights:** light bulb type H15 55 W/15 W
- **Perimeter lights:** light bulb type W 5 W
- **Turn signal indicators:** bulb type PY 21 W



- ① High beam/daytime running lights housing cover
- ② Dipped beam/perimeter lights housing cover
- ③ Indicator socket

- ▶ Switch off the lighting system.
- ▶ **High beam/daytime running lights:** pull back the housing cover ①.
- ▶ Turn the socket anti-clockwise and pull it out.
- ▶ Remove the bulb from the socket.
- ▶ Insert the new bulb into the socket such that the base of the bulb rests fully against the base of the socket.
- ▶ Insert the socket and turn it clockwise.
- ▶ Attach the housing cover ①.
- ▶ **Dipped beam/perimeter lights:** pull back the housing cover ②.
- ▶ Pull out the socket towards the rear.
- ▶ Remove the bulb from the socket.
- ▶ Insert the new bulb into the socket such that the base of the bulb rests fully against the base of the socket.
- ▶ Align and insert the socket.
- ▶ Attach the housing cover ②.
- ▶ **Turn signal indicator:** switch off the lighting system.
- ▶ Turn the socket ③ anti-clockwise and remove it.
- ▶ Gently turn the bulb anti-clockwise and take it out of the socket.
- ▶ Insert the new bulb into the socket and turn it clockwise.
- ▶ Insert the socket ③ and turn it clockwise.

Additional turn signal light

Requirements:

- **Additional turn signal light (all-wheel drive vehicles):** bulb type P 21 W

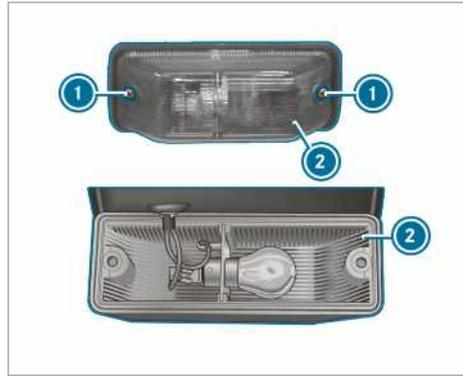

- ▶ Switching off the lighting system.
- ▶ Unscrew the screws ① and remove the light lens ②.
- ▶ Gently turn the bulb to the left and take it out of the socket.
- ▶ Insert the new bulb into the socket and turn it to the right.
- ▶ Place the light lens ② in position and tighten the screws ①.

Replacing rear light bulbs (panel vans and crewbuses)

Overview of rear bulb types (panel van and crewbus)

You can change the following bulbs.

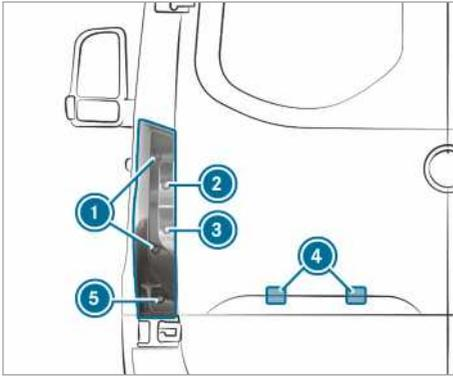

Vehicles with standard tail lamps

- ① Brake lights/tail lamps/perimeter lights: P 21 W
- ② Indicators: PY 21 W
- ③ Reversing lights: P 21 W
- ④ Licence plate lighting: W 5 W
- ⑤ Rear fog lights: P 21 W

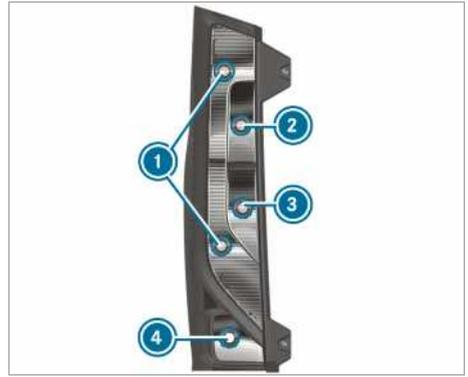

- ① Brake lights/tail lamps/perimeter lights
- ② Indicator
- ③ Reversing light
- ④ Rear fog light

- ▶ Switch off the lighting system.
- ▶ Open the rear door.

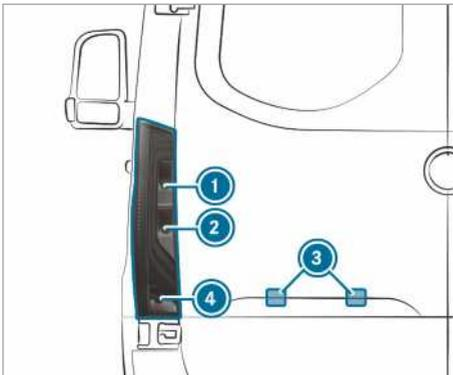

Vehicles with partial LED tail lamps

- ① Indicators: PY 21 W
- ② Reversing lights: P 21 W
- ③ Licence plate lighting: W 5 W
- ④ Rear fog lights: P 21 W

Tail lamps (panel van and crewbus)

Requirements:

- **Brake lights/tail lamps/perimeter lights:** light bulb type P 21 W
- **Indicators:** bulb type PY 21 W
- **Reversing lights:** bulb type P 21 W
- **Rear fog lights:** bulb type P 21 W

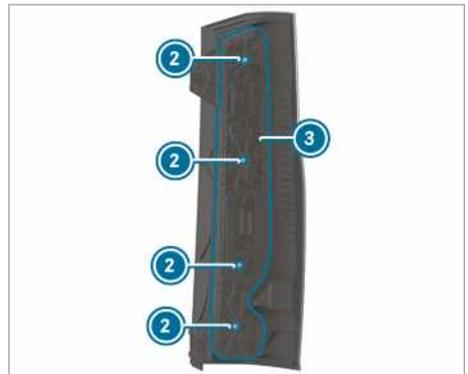
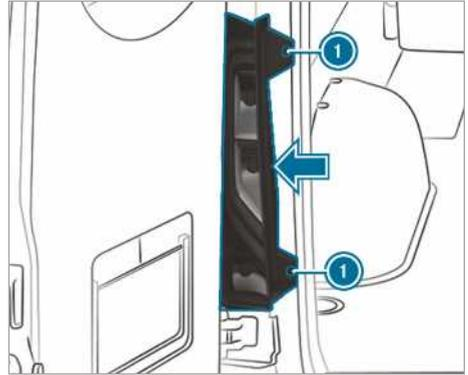

- ▶ **To remove:** loosen the screws ① and pull out the tail lamps in the direction of the arrow.
- ▶ Remove the connector from the bulb mount ③.
- ▶ Loosen the screws ② and remove the bulb mount ③ from the tail lamp.
- ▶ Gently turn the bulb anti-clockwise and take it out of the socket.
- ▶ Insert the new bulb into the socket and turn it clockwise.
- ▶ **To install:** set the bulb mount ③ on the tail lamp and screw in the screws ②.
- ▶ Press the connector into the bulb mount ③.
- ▶ Insert the tail lamp and screw in the screws ①.

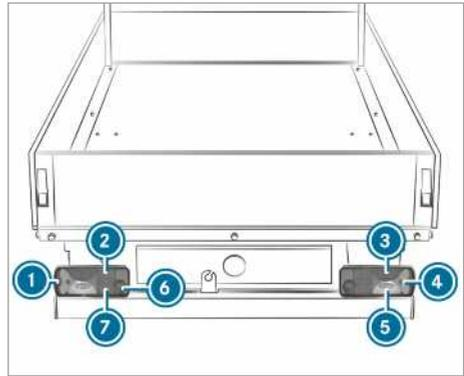

Vehicles with standard tail lamps

- ① Clearance lamp: R 5 W
- ② Tail light: R 5 W
- ③ Brake light: P 21 W
- ④ Indicators: PY 21 W
- ⑤ Reversing lights: P 21 W
- ⑥ Rear fog light (driver's side): P 21 W
- ⑦ Licence plate lighting: R 5 W

Licence plate lighting

Requirements:

- **Licence plate lighting:** light bulb type W 5 W



- ▶ Switch off the lighting system.
- ▶ Place a screwdriver, for example, at the opening ② between the lamp ③ and the panel ① and carefully prise off the lamp ③.
- ▶ Remove the lamp ③ from the panel ①.
- ▶ Rotate the bulb holder by around 45° and detach it from the lamp.
- ▶ Remove the light bulb.
- ▶ Insert the new bulb into the bulb holder.
- ▶ Insert the bulb holder into the lamp and rotate it by around 45°.
- ▶ Insert the lamp into the panel opening until it engages.

Replacing rear light bulbs (chassis)

Overview of rear bulb types (chassis)

You can change the following bulbs.

Replacing the tail lamps on the chassis

Requirements:

- **Rear fog lights:** bulb type P 21 W
- **License plate lighting:** bulb type R 5 W
- **Reversing lights:** bulb type P 21 W
- **Turn signal indicators:** bulb type PY 21 W
- **Clearance lamp:** bulb type R 5 W
- **Brake light:** bulb type P 21 W
- **Taillight:** bulb type R 5 W

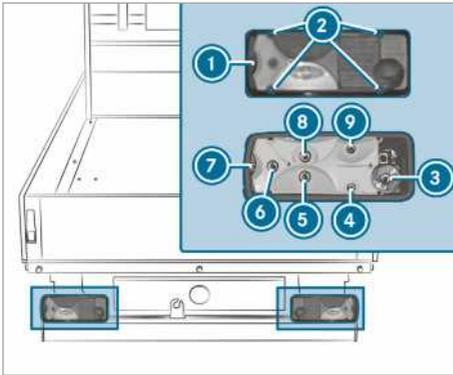

- ① Light lens
- ② Screws
- ③ Rear fog light
- ④ Licence plate lighting
- ⑤ Reversing light
- ⑥ Turn signal indicator
- ⑦ Clearance lamp
- ⑧ Brake light
- ⑨ Taillight

- ▶ Switch off the lighting system.
- ▶ Unscrew the screws ① and remove the light lens ②.
- ▶ Remove the plug connector from the lamp carrier.
- ▶ Gently turn the bulb anti-clockwise and take it out of the socket.
- ▶ Insert the new bulb into the socket and turn it clockwise.
- ▶ Position the light lens ② and tighten the screws ①.

Replacing bulbs in additional lamps

Side marker lamps

Requirements:

- **Side marker lamps:** light bulb type LED

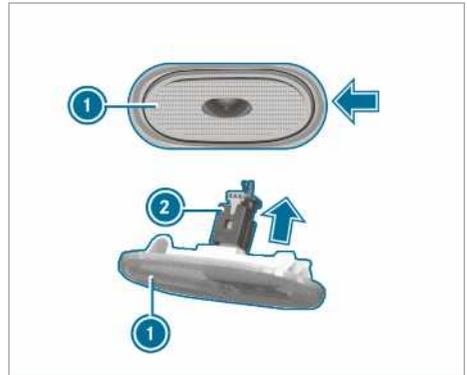

- ▶ Switch off the lighting system.
- ▶ Position a screwdriver, for example, at the side and carefully lever off side marker lamp ① in the direction of the arrow.
- ▶ Remove plug ② from side marker lamp ① in the direction of the arrow.
- ▶ Connect the new side marker lamp with the plug.
- ▶ Position the side marker lamp on the left and press in. The side marker lamp engages audibly.

Replacing interior light bulbs

Replacing rear interior lamps

Requirements:

- ① For the standard bulb failure indicator function to work correctly, only lights bulbs must be used that are the same type and power as those installed during production.

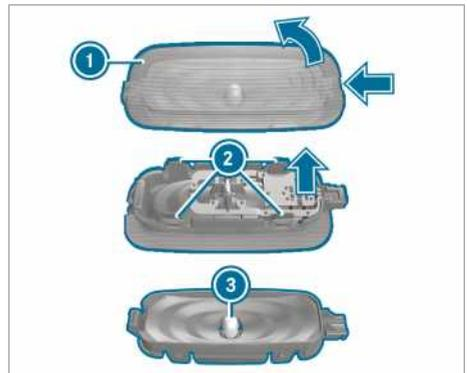

- ▶ Switch off the interior lighting.

- ▶ Press in the catch spring of lens ① with a suitable object e.g. a screwdriver, and then lever off the lens with the lamp housing.
- ▶ **To pull back lens from the lamp housing:** press the lugs of the lens ② inwards.
- ▶ Remove light bulb ③ from the lamp housing.
- ▶ Insert the new light bulb.
- ▶ Insert the lens in the lamp housing until it engages.
- ▶ Place the lens with the lamp housing in position and engage it.

Windscreen wipers

Switching the front windscreen wipers on and off

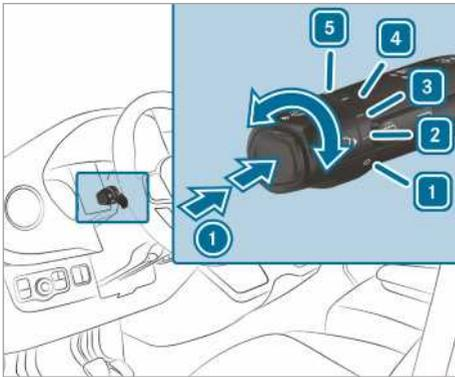

- ① Single wipe/wiping with washer fluid
- 1 Windscreen wipers off
- 2 Intermittent wiping, normal
Vehicles with rain sensors: automatic wiping, normal
- 3 Intermittent wiping, frequent
Vehicles with rain sensors: automatic wiping, frequent
- 4 Continuous wiping, slow
- 5 Continuous wiping, fast

- ▶ Turn the combination switch to the corresponding position 1 - 5.
- ▶ **Single wipe/washing:** press the button on the combination switch in the direction of arrow ①.
 - Single wipe
 - Wiping with washer fluid

Switching the rear window wipers on/off

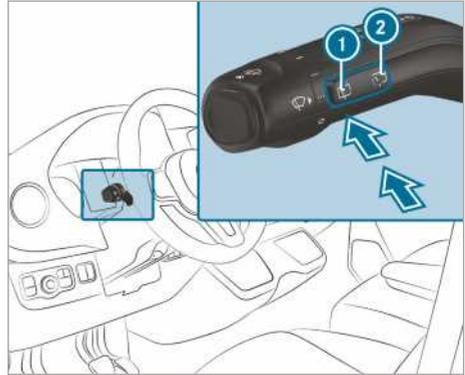

- ① Single wipe/wash
- ② Intermittent wiping

- ▶ **Single wipe:** press button ① to the point of resistance.
- ▶ **Wiping with washer fluid:** press button ① beyond the point of resistance.
- ▶ **To switch intermittent wiping on or off:** press button ②.
If the rear window wiper is switched on, the symbol will appear on the instrument display.

Replacing the windscreen wiper blades

- ⚠ **WARNING** Risk of becoming trapped if the windscreen wipers are switched on while wiper blades are being replaced

If the windscreen wipers begin to move while you are changing the wiper blades, you can be trapped by the wiper arm.

- ▶ Always switch off the windscreen wipers and ignition before changing the wiper blades.

- ⚠ **WARNING** Risk of injury from using the windscreen wipers while the engine bonnet is open

When the engine bonnet is open, and the windscreen wipers are set in motion, you can be trapped by the wiper linkage.

- ▶ Always switch off the windscreen wipers and ignition before opening the engine bonnet.

- ⓘ If the wiper blades are worn out, they will not wipe the windscreen properly. Replace the wiper blades twice a year, preferably in spring and autumn.

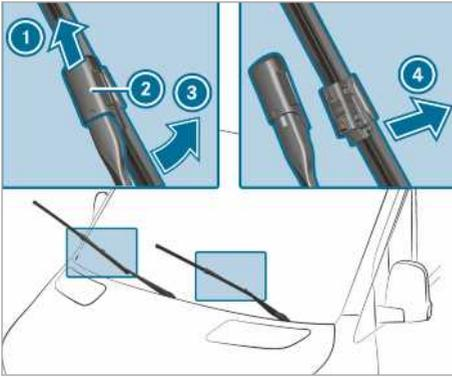

- ▶ Fold wiper arm ③ away from the windscreen.
- ▶ Hold wiper arm ③ and turn the wiper blade away from wiper arm ③ in the direction of the arrow as far as it will go.
- ▶ Slide catch ② upwards in the direction of the arrow until it engages.
- ▶ Fold back the wiper blade onto the wiper arm.
- ▶ Remove the wiper blade ① from wiper arm.
- ▶ Insert new washer blade ① in the holder on wiper arm ③.

When doing so, take into account the different lengths of the wiper blades:

- Driver's side: long wiper blade
 - Front passenger side: short wiper blade
- ▶ Slide catch ② downwards until it engages.
 - ▶ Fold wiper arm ③ back onto the windscreen.

Replacing the windscreen wiper blades (WET WIPER SYSTEM)

- ⚠ WARNING** Risk of becoming trapped if the windscreen wipers are switched on while wiper blades are being replaced

If the windscreen wipers begin to move while you are changing the wiper blades, you can be trapped by the wiper arm.

- ▶ Always switch off the windscreen wipers and ignition before changing the wiper blades.

- ⚠ WARNING** Risk of injury from using the windscreen wipers while the engine bonnet is open

When the engine bonnet is open, and the windscreen wipers are set in motion, you can be trapped by the wiper linkage.

- ▶ Always switch off the windscreen wipers and ignition before opening the engine bonnet.

- ⓘ If the wiper blades are worn out, they will not wipe the windscreen properly. Replace the wiper blades twice a year, preferably in spring and autumn.

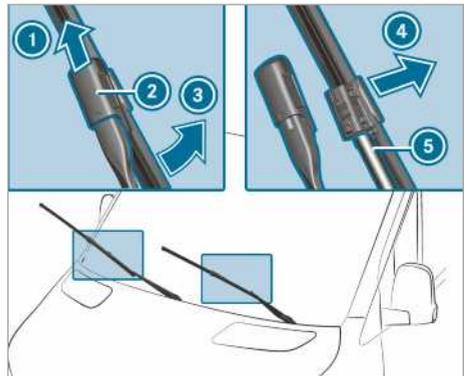

- ▶ Fold wiper arm ③ away from the windscreen.
- ▶ Hold wiper arm ③ and turn the wiper blade away from wiper arm ③ in the direction of the arrow as far as it will go.
- ▶ Slide catch ② upwards in the direction of the arrow until it engages.
- ▶ Remove wiper blade ① from the wiper arm in the direction of arrow ④.
- ▶ Carefully remove hose ⑤ from the wiper blade.
- ▶ Attach hose ⑤ to the new wiper blade.
- ▶ Insert new washer blade ① in the holder on wiper arm ③.

When doing so, take into account the different lengths of the wiper blades:

- Driver's side: long wiper blade
 - Front passenger side: short wiper blade
- ▶ Slide catch ② downwards until it engages.
 - ▶ Fold back the wiper blade onto the wiper arm.

- ▶ Fold wiper arm ③ back onto the windscreen.

Replacing the rear window wiper blade

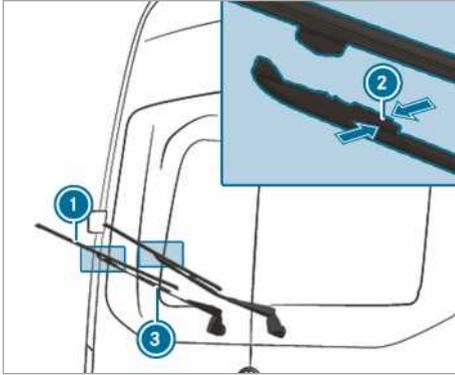

- ▶ Fold wiper arm ③ away from the rear window.
- ▶ Press both retaining clips ② in the direction of the arrow and swivel the wiper blade away from the wiper arm.
- ▶ Pull wiper blade ① upwards out of the holder on wiper arm ③.
- ▶ Insert new washer blade ① in the holder on wiper arm ③.
- ▶ Push the new wiper blade ① onto the wiper arm ③ until the retaining clips engage.
- ▶ Fold the wiper arm ③ back onto the rear window.

Mirrors

Operating the outside mirrors

- ⚠ **WARNING** Risk of injury through adjusting vehicle settings while the vehicle is in motion

You could lose control of the vehicle in the following situations:

- if you adjust the driver's seat, the head restraints, the steering wheel or the mirror while the vehicle is in motion
- if you fasten your seat belt while the vehicle is in motion
- ▶ Before starting the engine: adjust the driver's seat, the head restraints, the

steering wheel or the mirror and fasten your seat belt.

- ⚠ **WARNING** Risk of accident due to misjudgement of distances when using the outside mirror

The outside mirrors reflect objects on a smaller scale. The objects in view are in fact closer than they appear.

As a result, you may misjudge the distance between you and the road user driving behind you, e.g. when changing lanes.

- ▶ Therefore, always look over your shoulder in order to ensure that you are aware of the actual distance between you and the road users driving behind you.

Adjusting the outside mirrors manually

- ▶ Adjust the outside mirrors to the correct position manually.
- ▶ **To engage an outside mirror that has been pushed out of position:** push the outside mirror into position manually.

Adjusting the outside mirrors electrically

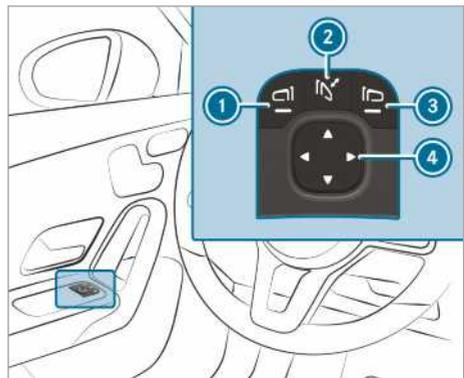

Example image

- ⓘ **NOTE** Damage to the electric outside mirrors

If you fold the electric outside mirrors in or out manually, you may damage the outside mirrors and they will not lock in place properly.

If the outside mirrors are not folded in when washing the vehicle in a car wash, the washer brushes may fold them in forcibly and damage them.

- ▶ The outside mirrors must only be folded in and out electrically.
- ▶ Fold the outside mirrors in before washing the vehicle in a car wash.

▶ Before driving off, switch on the power supply or the ignition.

▶ **To fold in or out:** briefly press button ②.

▶ **To adjust:** use button ① or ③ to select the outside mirror to be adjusted.

▶ Set the position of the mirror glass by pressing button ④.

▶ **To engage an outside mirror that has been pushed out of position:** press and hold button ②.

You will hear a click and the mirror will audibly engage in position. The outside mirror is set in the correct position.

Heating the outside mirrors

▶ **Vehicles without a rear window heater:** at low temperatures, the mirror heating switches on automatically when the engine is started.

▶ **Vehicles with a rear window heater:** at low temperatures, the mirror heater switches on automatically when the engine is started. The mirror heater can also be switched on together with the rear window heater using the rear window heater button.

▶ **To dim the inside rearview mirror:** move anti-dazzle lever ① in the direction of the arrow.

Operating sun visors

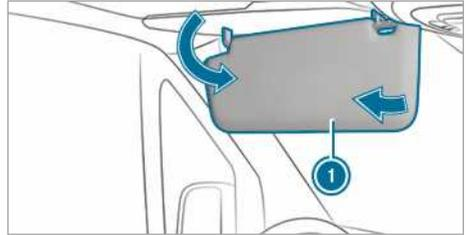

▶ **Glare from front:** Fold the sun visor ① downwards.

▶ **Glare from the side:** Swivel the sun visor ① to the side.

Dimming the inside rearview mirror

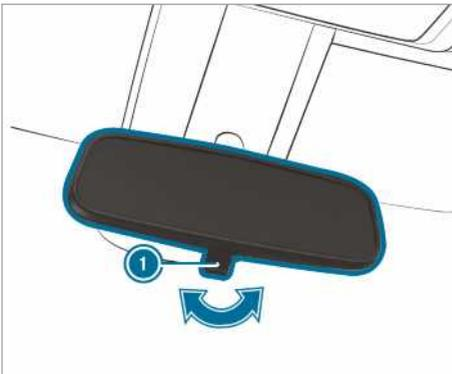

Overview of climate control systems

Heating system overview

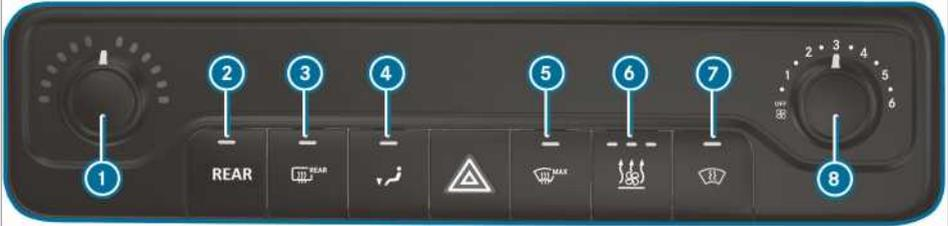

- ① Sets the temperature
- ② **REAR** /  Switches the rear-compartment heating on/off
- ③  Switches the rear window heater on/off (→ page 106)
- ④  Switches footwell air distribution on/off
- ⑤  Switches windscreen defrosting on/off (→ page 105)
- ⑥ Vehicles with stationary heater or heater booster:  switches the stationary heater or heater booster on/off (→ page 108)
- ⑦  Vehicles with windscreen heating:
- ⑧ Sets the airflow

switches windscreen heating on/off (→ page 106)

Vehicles with windscreen heating:

- ① The indicator lamps on the buttons signal that the function in question has been activated.

TEMPMATIC overview

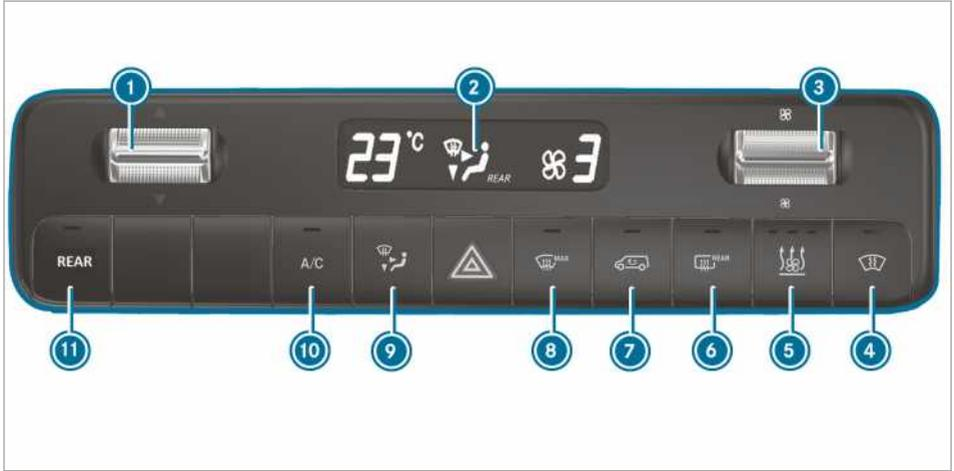

- ① Sets the temperature
 - ② Display
 - ③ Sets the airflow
 - ④ Vehicles with windscreen heating: switches windscreen heating on/off (→ page 106)
 - ⑤ Vehicles with stationary heater or heater booster: switches the stationary heater or heater booster on/off (→ page 108)
 - ⑥ Vehicles with rear window heating: switches rear window heating on/off (→ page 106)
 - ⑦ Switches air-recirculation mode on/off (→ page 106)
 - ⑧ Switches windshield defrosting on/off (→ page 105)
 - ⑨ Adjusts the air distribution (→ page 105)
 - ⑩ Switches the A/C function on/off (→ page 104)
 - ⑪ Vehicles with dual-zone climate control systems: adjusts the rear-compartment climate control/heating (indicator lamp flashes) (→ page 104)
- i** The indicator lamps on the buttons signal that the function in question has been activated.

THERMOTRONIC overview

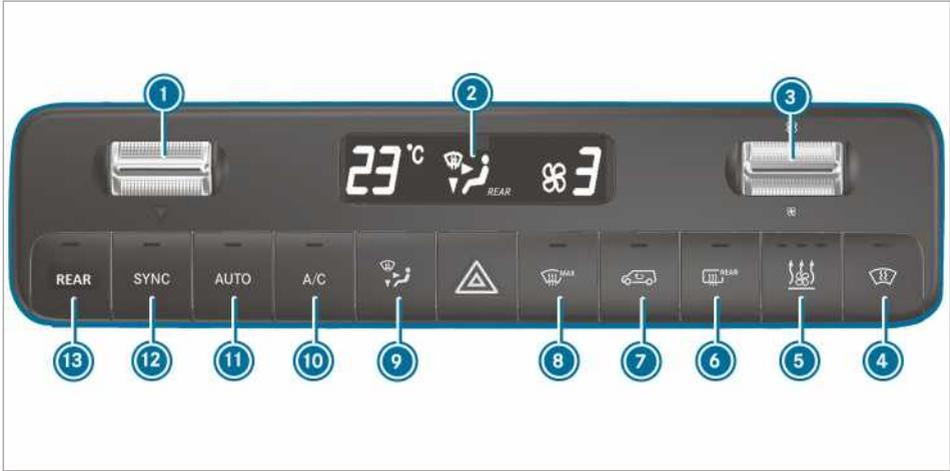

1 ▼▲ Sets the temperature

2 Display

3  Sets the airflow



Vehicles with windscreen heating: switches windscreen heating on/off (→ page 106)

5 Vehicles with stationary heater or heater booster:  switches the station-

ary heater or heater booster on/off (→ page 108)

6 Vehicles with rear window heating:  switches rear window heating on/off (→ page 106)

7  Switches air-recirculation mode on/off (→ page 106)

8  Switches windscreen defrosting on/off (→ page 105)

9  Adjusts the air distribution (→ page 105)

10  Switches the A/C function on/off (→ page 104)

11  Automatically controls the climate control, front (→ page 104) and rear (→ page 104)

12  Switches synchronisation on/off (→ page 105)

13  Vehicles with dual-zone climate control systems: adjusts the rear-compartment climate control/heating (indicator lamp flashes) (→ page 104)

i The indicator lamps on the buttons signal that the function in question has been activated.

i When the climate control system is switched off, the windows may mist up more quickly. Switch the climate control system off only briefly.

i If the front-compartment system has already been switched on and the rear-compartment system has been switched off, you can switch it on by turning up the fan on the rear-compartment menu. If the front-compartment system is switched on, the rear-compartment system will automatically switch on as well.

Operating climate control systems

Switching the climate control system on or off

▶ **To switch on:** set the airflow to 1 or higher on the front-compartment menu.

▶ **To switch off:** set the airflow to 0 or **OFF** on the front-compartment menu. **OFF** appears on the climate control system display.

Adjusting the rear-compartment climate control

Requirements:

- The climate control system has been switched on (→ page 103).

Switching on the temperature and airflow and adjusting TEMP/MATIC and THERMOTRONIC

Press the  /  button.

The indicator lamp on the  /  but-

ton and the  /  symbol on the climate control system display will flash.

The display switches to the temperature and the blower in the rear menu.

- Use rocker switches   and  to set the required temperature and airflow on the rear-compartment menu.

-  If there are significant differences between the temperature settings of the front and rear systems, these cannot be controlled accurately.
-  If the rear-compartment climate control has been switched off, you can switch it on automatically by pressing the  button.

Depending on the vehicle equipment, climate control switches on the overhead air-conditioning system or rear-compartment heating as required:

- Vehicles with an overhead air-conditioning system:** the rear compartment can be cooled only.
- Vehicles with rear-compartment heating:** the rear compartment can be heated only.

Switching off TEMP/MATIC and THERMOTRONIC rear-compartment climate control

Press the  /  button.

If the indicator lamp on the  /  but-

ton and the  /  symbol on the climate control system display flash, set the airflow to 0 on the rear-compartment menu.

-  Indicator lamp on: rear-compartment climate control has been switched on.
Indicator lamp off: rear-compartment climate control has been switched off.
Indicator lamp flashes: the setting mode of the rear-compartment climate control is active.

Switching the A/C function on and off

Requirements:

- The climate control system has been switched on (→ page 103).

The A/C function controls the climate and dries the air inside the vehicle.

- Press the  button.

-  Switch off the A/C function only briefly. Otherwise, the windows could mist up faster.
-  Condensation may leak from the underside of the vehicle in cooling mode. This is not a sign of a defect.

Automatically regulating climate control

Requirements:

- The climate control system is switched on (→ page 103).

Switching on automatic climate control

In automatic mode, the temperature, airflow and air distribution are regulated and kept constant.

- Press the  button.

The display will show the temperature. The airflow and air distribution will disappear from the display.

If the rear-compartment climate control has been switched on, the setting for the rear is carried over.

Switching off automatic climate control

- Use the rocker switch  to change the airflow setting and air distribution (→ page 105).
The other setting remains unaffected by the change.

Automatically controlling the climate control in the rear

Requirements:

- Rear-compartment climate control has been switched on (→ page 104).

In automatic mode, the temperature, airflow and air distribution are regulated and kept constant.

▶ Press the  /  button.

▶ Press the  button.

- ① Even if the front-compartment system is in automatic mode, the rear-compartment system can exit automatic mode if you adjust the blower on the rear-compartment menu.
- ① If the air is cooled and the driver, front passenger or sliding door is opened, the rear air conditioning system blower is turned down after around 15 minutes. When all doors have been closed again, the blower will be reset to the previous setting after around one minute.

Information on the air distribution settings

The symbols on the display indicate the vents through which the air is being directed.

TEMPMATIC

-  Defroster and centre vents
-  All vents
-  Centre vents
-  Centre and footwell vents

THERMOTRONIC

-  Defroster vents
-  Defroster and centre vents
-  All vents
-  Defroster and footwell vents
-  Centre vents
-  Centre and footwell vents
-  Footwell vents

Setting the air distribution

Requirements:

- The climate control system is switched on.
- ▶ Press the  button repeatedly until the desired air distribution appears in the air conditioning system display.

Switching the synchronisation function on and off

Requirements:

- The climate control system has been switched on (→ page 103).

The synchronisation function controls the climate control function centrally. The settings for the temperature and airflow in the front zone are automatically adopted for the rear zone.

▶ Press the  button.

- ① If the rear-compartment climate control has been switched off, you can switch it on automatically by pressing the  button.

Demisting the windows

Misting on the inside of windows

▶ Press the  button.

When the windscreen defroster is switched on, the temperature and airflow cannot be adjusted.

▶ In vehicles with a heating system and a manual air-conditioning system, also close the side and centre air vents (→ page 106) as well as the air vents for the rear compartment (→ page 107).

▶ Vehicles with TEMPMATIC or

THERMOTRONIC: press the  button and, if necessary, use the  button to direct the air onto the windscreen .

▶ Increase the airflow as necessary and close all air vents (→ page 106).

▶ If the windows remain misted up: press the  button.

When the windscreen defroster is switched on, the temperature and airflow cannot be adjusted.

 or no symbol will appear on the climate control system display.

▶ **Vehicles with windscreen heating:** press



the button.

▶ Close the centre air vents (→ page 106) and air vents for the headroom (→ page 107) and rear compartment (→ page 107).

Misting on the outside of windows

- ▶ Switch on the windscreen wipers (→ page 97).

Switching air-recirculation mode on and off

- ▶ Press the  button.
The interior air is recirculated.

The air-recirculation mode switches off automatically.

- ⓘ When air-recirculation mode is switched off, the windows may mist up more quickly.

Switch on air-recirculation mode only briefly.

Air-recirculation mode automatically switches on in the following cases:

- at high outside temperatures
- when the vehicle is driving through a tunnel (vehicles with THERMOTRONIC automatic climate control and navigation only)
- when the windscreen wipers are switched on (→ page 97)

The indicator lamp on the  button will not light up in this case. After a maximum of 30 minutes, outside air is automatically introduced again.

Convenience opening/closing via the air recirculation button

- ▶ **Convenience closing:** press the  button until the side windows begin to close automatically.
The initial position of the side windows is saved.
- ▶ **Convenience opening:** press the  button until the side windows begin to open automatically.
The side windows open automatically until they have reached their previously saved position.

Switching the windscreen heating on and off

- ⓘ In the event of high outside temperatures, the windscreen heater may not turn on.
- ▶ Press the button for the windscreen heater. If the indicator lamp lights up, the windscreen heater is switched on.
- ⓘ The windscreen heater switches off automatically after a few minutes.

- ⓘ If the battery voltage is too low, it may not be possible to switch the windscreen heater on. If the battery voltage becomes too low while the windscreen heater is in operation, the windscreen heater will switch off automatically.

Switching the rear window heater on or off

- ▶ Press the  button.
If the indicator lamp lights up, the rear window heater is switched on.

Operating air vents

Adjusting the front-compartment air vents

- ⚠ **WARNING** - Risk of burns/frostbite due to not maintaining a sufficient distance to the air vents

Very hot or very cold air can flow from the air vents.

This could result in burns or frostbite in the immediate vicinity of the air vents.

- ▶ Always ensure that all vehicle occupants maintain a sufficient distance to the air vents.
- ▶ If necessary, redirect the airflow to another area of the vehicle interior.

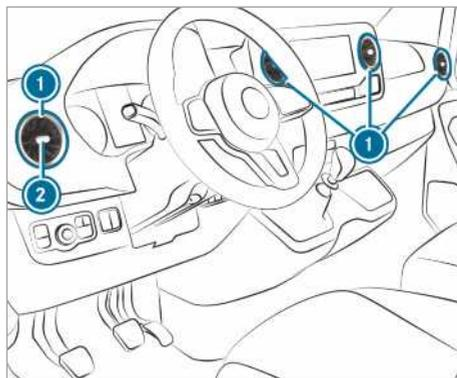

- ▶ **To open or close:** hold the centre  of the air vent  and turn it to the left or right as far as it will go.
- ▶ **To set the air direction:** hold the centre  of the air vent  and swivel it upwards, downwards, to the left or to the right.

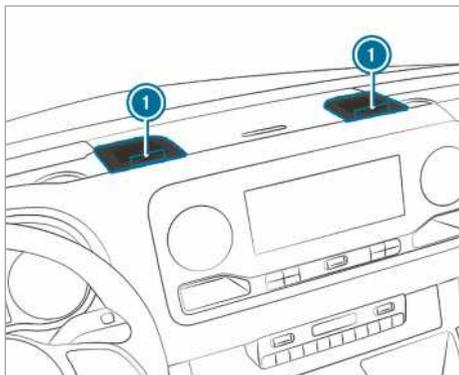

▶ **To open or close:** turn the adjustment wheels ① on the high-power air vents to the left or right as far as they will go.

ⓘ Cooled air will flow out of the high-power air vents. Heating will not be possible. Open the high-power air vents only in summer during cooling mode and keep them closed in winter.

Adjusting air vents in the roof air duct



In vehicles with rear-compartment air conditioning, adjustable air vents have been integrated in the roof air duct.

▶ **Adjusting the airflow:** if necessary, open or close the air flaps in the air vents ①.

▶ **Adjusting the air distribution:** turn the air vents ① to the required position.

Ventilation nozzles in the rear

⚠ WARNING - Risk of burns/frostbite due to not maintaining a sufficient distance to the air vents

Very hot or very cold air can flow from the air vents.

This could result in burns or frostbite in the immediate vicinity of the air vents.

- ▶ Always ensure that all vehicle occupants maintain a sufficient distance to the air vents.
- ▶ If necessary, redirect the airflow to another area of the vehicle interior.

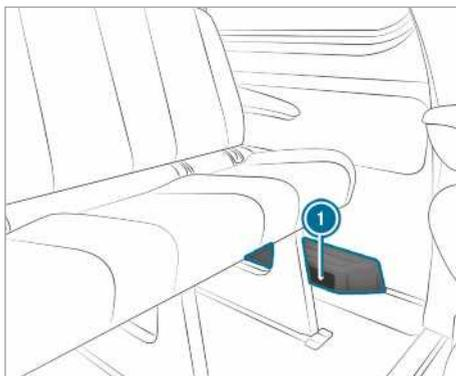

Depending on the vehicle equipment, there will be an air duct or a heater with additional air nozzles in the rear footwell on the left-hand side ①. No objects may be placed there. Passengers must maintain a sufficient distance due to the warm air flow and air intake.

Auxiliary heating

Function of the auxiliary heating

⚠ DANGER Risk of fatal injury due to poisonous exhaust gases

If the tailpipe is blocked or sufficient ventilation is not possible, poisonous exhaust gases such as carbon monoxide may enter the vehicle. This is the case in enclosed spaces or if the vehicle gets stuck in snow, for example.

- ▶ Always switch the stationary heater off in enclosed spaces without an air extraction systems, e.g. in garages.

- ▶ Keep the tailpipe and the area around the vehicle free from snow when the engine or the stationary heater are running.
- ▶ Open a window on the windward side of the vehicle to ensure an adequate supply of fresh air.

⚠ WARNING Risk of fire due to hot stationary heater components

When the stationary heater is switched on, parts of the vehicle can become very hot, e.g. the stationary heater exhaust system.

Flammable materials such as leaves, grass or twigs may ignite if they come into contact with:

- hot parts of the stationary heater exhaust system
- the exhaust gas itself

There is a risk of fire.

- ▶ When the stationary heater is switched on, make sure that:
 - hot vehicle parts do not come into contact with flammable materials.
 - the exhaust gas can flow out of the stationary heater exhaust pipe unhindered.
 - the exhaust gas does not come into contact with flammable materials.

ℹ NOTE Damage to the auxiliary heating

If the auxiliary heating is not used for an extended period of time, it can be damaged.

- ▶ Switch the auxiliary heating on for around ten minutes at least once a month.

ℹ NOTE Damage to the auxiliary heating due to overheating

If the hot air flow is blocked, the auxiliary heating can overheat and switch off.

- ▶ Do not block the hot air flow.

- ℹ Vehicles with modified fuel displays:** if an externally operated consumer is connected via the cable for the auxiliary heater, this is not taken into consideration on the "range remaining" display of the on-board computer.

In this case, observe the fuel display. The fuel display provides the current level.

If you are transporting hazardous materials, comply with the relevant safety regulations. Always place objects at a sufficient distance from the outlet opening of the auxiliary heating.

Auxiliary heating works independently of the engine and complements the climate control system in the vehicle. Auxiliary heating heats the air inside the vehicle to the set temperature.

Hot-water auxiliary heater

Function of the hot-water auxiliary heater

The hot-water auxiliary heater complements your vehicle's climate control system, and has a heater booster, auxiliary heating and auxiliary ventilation function. In addition, the auxiliary heating system heats the engine coolant to protect the engine and save fuel during the warming-up phase. The auxiliary heating heats the air inside the vehicle to the set temperature. It is not dependent on the heat output of the running engine. The auxiliary heating is operated directly using the vehicle's fuel. For this reason, the fuel tank must have been filled above the reserve fuel level so that the auxiliary heating can work. The auxiliary heating automatically adapts its operating mode to the outside temperature and weather. It is therefore possible that the auxiliary heating may switch from ventilation to heating mode or from heating to ventilation mode. When the engine is running, auxiliary ventilation is not active. Auxiliary heating automatically switches itself off after a maximum of 50 minutes. You cannot use the "auxiliary ventilation" operating mode to cool the air inside the vehicle to below the outside temperature. Auxiliary heating helps to heat up the vehicle while the engine is running and at low outside temperatures.

Operating the hot-water auxiliary heater draws power from the vehicle battery. Therefore, drive a reasonably long distance after heating or ventilating the vehicle twice in succession at most.

Switching the hot-water auxiliary heater on and off with the button

Requirements:

- The fuel tank is filled above the reserve fuel level.

Switching auxiliary heating on and off

- ▶ **To switch on:** press the  button.

- ▶ **To switch off:** press the  button.

Switching on the specified temperature

- ▶ Switch on the ignition.
- ▶ **To switch on:** press the  button.
- ▶ **To switch off:** press the  button.
- ▶ Set the temperature using the  button.
- ▶ Press the  button.
The red or blue indicator lamp on the  button goes on or off.

Colours of the indicator lamp:

- **Blue:** auxiliary ventilation has been switched on.
- **Red:** auxiliary heating has been switched on.
- **Yellow:** departure time has been pre-selected.

Auxiliary heating or ventilation switches off after a maximum of 50 minutes.

Switching heater booster mode on and off

- ▶ **To switch on:** start the engine.
- ▶ Press the  button.
- ▶ **To switch off:** press the  button.
Heater booster mode will be switched on at an outside temperature of less than 0 °C when necessary.

- ⓘ Heater booster mode is available only for vehicles with hot-water auxiliary heaters.

Adjusting the hot water auxiliary heater by remote control

Requirements:

- The fuel tank is filled above the reserve fuel level.

Switching on immediately



- ▶ Press and hold the  button until the **ON** message appears on the remote control's display.

Setting the departure time

- ▶ Briefly press the  button.
- ▶ Continue to press the  or  button until the time to be changed appears on the display.
- ▶ Press the  and  buttons simultaneously. The  symbol on the remote control display will flash.
- ▶ Set the required departure time with the  and  buttons.
- ▶ Press the  and  buttons simultaneously. The new departure time will be saved.

Up to three departure times can be saved.

- ▶ **To activate the departure time:** briefly press the  button.
- ▶ Select the required departure time with the  and  buttons.
- ▶ Press and hold the  button. The  symbol, the departure time and, depending on the selected departure time, letter **A**, **B** or **C** will appear on the remote control's display.
- ▶ **To deactivate the departure time:** select the required departure time and press and hold the  button. **OFF** will appear on the display.
- ▶ **To check the status of the active stationary heater:** briefly press the  button.

Switching off immediately

▶ Press and hold the **OFF** button.

Overview of remote control displays (stationary heating/ventilation)

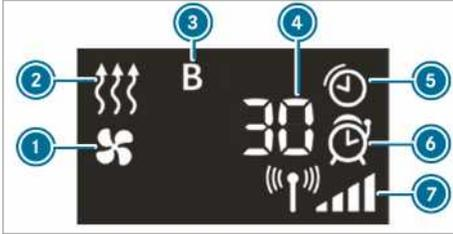

- ① Stationary ventilation switched on
- ② Stationary heating switched on
- ③ Selected departure time
- ④ Remaining stationary heating or ventilation time (in minutes)
- ⑤ Stationary heating or ventilation active
- ⑥ Departure time activated
- ⑦ Signal strength

Further display options:

- **Time:** The selected departure time.
- **0 minutes:** The runtime of the stationary heating extends as the engine has not yet reached the operating temperature.
- **OFF:** Stationary heating or ventilation has been switched off.

Changing the remote control's battery (stationary heating)

⚠ DANGER Serious damage to health caused by swallowing batteries

Batteries contain toxic and corrosive substances. Swallowing batteries may cause serious damage to health.

There is a risk of fatal injury.

- ▶ Keep batteries out of the reach of children.
- ▶ If batteries are swallowed, seek medical attention immediately.

🔥 ENVIRONMENTAL NOTE Environmental damage due to improper disposal of batteries



Batteries contain toxic and corrosive substances.



Take discharged batteries to a qualified specialist workshop or to a collection point for used batteries.

Requirements:

- A CR2450 lithium battery is available.

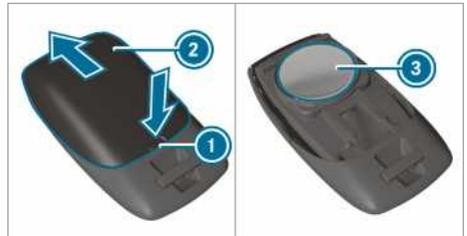

- ▶ Push a pointed object into the recess ①.
- ▶ Slide battery cover ② backwards in the direction of the arrow.
- ▶ Insert the new battery ③ with the lettering facing upwards.
- ▶ Slide the battery cover ② onto the remote control in the opposite direction to the arrow until the battery cover engages.

Adjusting the hot-water auxiliary heater with the on-board computer

Requirements:

- The fuel tank is filled above the reserve fuel level.
- The ignition is switched on.

On-board computer:

➤ **Settings** ➤ **Heating**

Setting the switch-on time

- ▶ Select **Settings**.
- ▶ Select the desired departure time.

Activating the departure time

- ▶ Activate the departure time by ticking the box.
- ⓘ Ensure that A, B and C each correspond to a programmed departure time.
- ⓘ The programmed time remains set only until the next time the engine is started.

Selecting programmed time

- ▶ Set the required programmed time A, B or C.
- ⓘ The required programmed time A, B or C will appear only if the box to activate the departure time is ticked.
- ▶ Select the required programmed time by swiping left or right, e.g. A, B or C.

Problems with hot water auxiliary heating

Problem	Possible causes/consequences and ▶ Solutions
FAIL 	Signal transmission between transmitter and vehicle is malfunctioning. ▶ Change your position in relation to the vehicle, moving closer if necessary.
FAIL	The starter battery is not sufficiently charged. ▶ Charge the starter battery.
	The fuel tank is not filled up to the reserve level. ▶ Refuel at the nearest filling station.
FAIL 	Auxiliary heating is malfunctioning. ▶ Have the auxiliary heating checked at a qualified specialist workshop.

Auxiliary warm-air heater

Timer overview

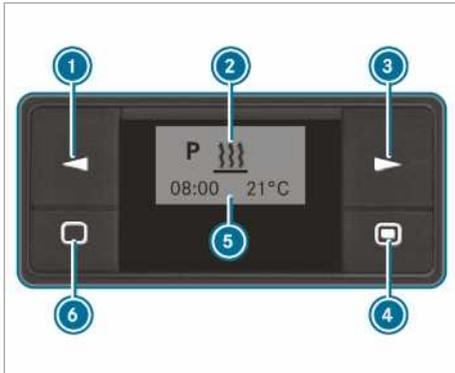

- ① Select option/change values
- ② Menu bar
- ③ Select option
- ④ Press briefly to select or confirm a setting/press and hold to switch immediate heating mode on/off

- ⑤ Status bar
- ⑥ Press briefly to switch on the timer/cancel or terminate the settings in a menu; press and hold to terminate all functions

Setting the timer

- ▶ Press the ⑥ button.
- ⓘ The timer will switch to standby mode after ten seconds. The display will go off.

Setting the timer

Setting the time

You must reset the day, time and default value for the operating duration in the following cases:

- initial operation
- after a voltage supply interruption (e.g. if the battery has been disconnected)
- after a malfunction
- ▶ Press button ① or ③ until  flashes on the menu bar ②.
- ▶ Press the ④ button.
- ▶ Press button ① or ③ until  flashes.
- ▶ Press the ④ button.
- ▶ Set the hour with button ① or ③.

- ▶ Press the **4** button.
- ▶ Set the minutes with button **1** or **3**.
- ▶ Press the **4** button.

Setting the time format

- ▶ Press button **1** or **3** until  flashes on the menu bar **2**.
- ▶ Press the **4** button.
- ▶ Press button **1** or **3** until the symbol for the time format flashes.
- ▶ Press the **4** button.
- ▶ Select the desired time format using button **1** or **3**.
- ▶ Press the **4** button.

Setting the day

- ▶ Press button **1** or **3** until  flashes on the menu bar **2**.
- ▶ Press the **4** button.
- ▶ Press the **1** or **3** button until the symbol for the day flashes.
- ▶ Press the **4** button.
- ▶ Use the **1** or **3** button to select the required day of the week.
- ▶ Press the **4** button.

Switching immediate heating mode on/off

- ▶ **To switch on:** press button **4** until  flashes on menu bar **2**.
On briefly appears on the display and then the remaining operating duration or the  symbol for continuous operation.
- ▶ **To switch on:** press button **4** until Off appears on the display.

Setting the departure time

You can set three departure times with the switch clock. Following malfunctions or if the battery

has been disconnected, you will need to re-set the departure times.

- ▶ **To set the departure time:** press the **1** or **3** button until **P** flashes on the **2** menu row.
- ▶ Press the **4** button.
The numbers of the program memories are shown in the program column **5**. The tick denotes activated program memories.
- ▶ Use the **1** or **3** button to select the required program memory.
- ▶ Press the **4** button.
- ▶ **To activate/deactivate program memories:** use the **1** or **3** button to select On or Off.
- ▶ Press button **4**.
- ▶ **To edit the program memory:** use the **1** or **3** button to select .
- ▶ Press the **4** button.
- ▶ Set the day of the week and the time (→ page 111).

Setting the temperature and operating duration

- ▶ Press the **4** button.
- ▶ Set the temperature with button **1** or **3**.
- ▶ Press the **4** button.
- ▶ Set the operating duration with button **1** or **3** or select the  symbol for continuous operation.
- ▶ Press the **4** button.
- ▶ **i** The operating duration set is the default setting for immediate heating mode. You can set the operating duration within a range of 10 to 120 minutes or to continuous operation.

Problems with the auxiliary warm-air heater

Problem	Possible causes/consequences and ▶ Solutions
The message ERROR appears on the switch clock's display.	A malfunction has occurred. ▶ Have the auxiliary heating checked at a qualified specialist workshop.
The message INIT appears on the switch clock's display.	The power supply has been interrupted. All saved settings have been deleted. Automatic hardware detection is currently active.

Problem	Possible causes/consequences and ► Solutions
	<ul style="list-style-type: none"> ► When automatic hardware detection is complete, set the day of the week, time and operating duration (→ page 111). ► Set the departure time (→ page 112).
Auxiliary heating automatically switches off and/or cannot be switched on.	<p>The low-voltage protection system integrated in the control unit switches auxiliary heating off as the on-board voltage is below 10 V.</p> <ul style="list-style-type: none"> ► Have the generator and the battery checked. <p>The electrical fuse has blown.</p> <ul style="list-style-type: none"> ► Replace the electrical fuse; see "Fuse assignment" supplement. ► Have the cause of the faulty fuse investigated at a qualified specialist workshop.
The auxiliary warm-air heating is overheated.	<p>The air ducts are clogged.</p> <ul style="list-style-type: none"> ► Ensure that the flow of hot air is not blocked. ► Have the auxiliary heating checked at a qualified specialist workshop.

Operating cargo compartment ventilation

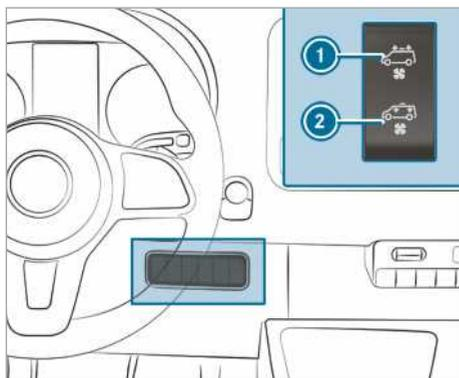

If your vehicle is equipped with a roof ventilator, you can admit fresh air to the load compartment, or extract air from it as well.

- Switch on the ignition.
- **To switch on and extract:** press the switch ① at the top.
The roof ventilator removes used air from the load compartment.
- **To switch on and admit fresh air:** press the switch ② at the bottom.
The roof ventilator feeds fresh air into the load compartment.
- **To switch off:** place the switch in the centre position.

Driving

Switching on power supply or ignition with the start/stop button

▲ WARNING Risk of accident and injury due to children left unattended in the vehicle

If children are left unattended in the vehicle, they could:

- open doors, thereby endangering other persons or road users.
- get out of the vehicle and be hit by oncoming traffic.
- operate vehicle equipment and become trapped, for example.

In addition, children could also set the vehicle in motion, for example, by:

- releasing the parking brake.
- shifting the automatic transmission out of park position **P** or shifting manual transmission into neutral.
- starting the engine.

- ▶ When leaving the vehicle, always take the key with you and lock the vehicle.
- ▶ Never leave children and animals unattended in the vehicle.
- ▶ Keep the vehicle key out of reach of children.

▲ DANGER Risk of fatal injuries due to exhaust gases

Combustion engines emit poisonous exhaust gases such as carbon monoxide. Inhaling these exhaust gases is hazardous to health and can lead to poisoning.

- ▶ Never leave the engine running in an enclosed space without sufficient ventilation.

▲ WARNING Risk of fire caused by flammable material on the exhaust system

Flammable materials brought in by either animals or environmental influences may ignite if they come into contact with hot parts of the engine or exhaust system.

- ▶ Therefore, check regularly that there are no flammable materials in the engine compartment or on the exhaust system.

Requirements:

- the key is in detection range of the aerial (→ page 45) and the key battery is not discharged.

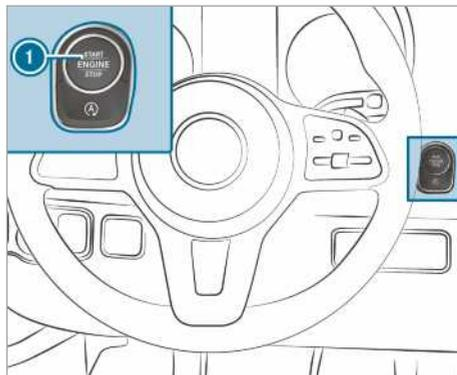

- ▶ **To switch on the power supply:** press button ① once.
You can now activate the windscreen wipers, for example.

The power supply is switched off again when one of the following conditions is met:

- the driver's door is open.
- you press button ① twice.

- ▶ **To switch on the ignition:** press button ① twice.
The indicator lamps appear in the instrument cluster.

The ignition is switched off again when one of the following conditions is met:

- you do not start the vehicle within 15 minutes.
- you press button ① once.

Starting the engine

Starting the vehicle with the start/stop button

⚠ WARNING Risk of accident and injury due to children left unattended in the vehicle

If children are left unattended in the vehicle, they could:

- open doors, thereby endangering other persons or road users.
- get out of the vehicle and be hit by oncoming traffic.
- operate vehicle equipment and become trapped, for example.

In addition, children could also set the vehicle in motion, for example, by:

- releasing the parking brake.
- shifting the automatic transmission out of park position **P** or shifting manual transmission into neutral.
- starting the engine.

- ▶ When leaving the vehicle, always take the key with you and lock the vehicle.
- ▶ Never leave children and animals unattended in the vehicle.
- ▶ Keep the vehicle key out of reach of children.

Requirements:

- the key is in detection range of the aerial (→ page 45) and the key battery is not discharged.

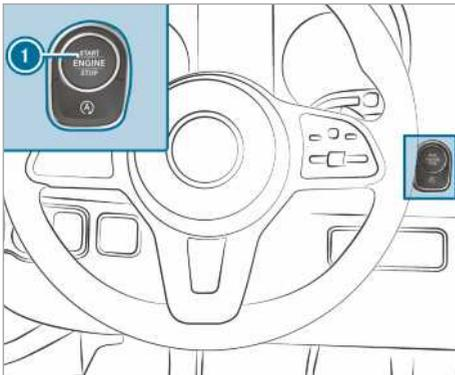

▶ **Vehicles with manual transmission:**
depress the clutch pedal.

▶ **Vehicles with automatic transmission:**
shift the transmission to position **P** or **N**.

▶ Depress the brake pedal and press button **1** once.

▶ If the vehicle does not start: switch off unnecessary consumers and press button **1** once.

▶ If the vehicle still does not start and the display message **Place the key in the marked space** See *Owner's Manual* appears in the multifunction display: start the vehicle in emergency operation mode.

Starting the vehicle in emergency operation mode

⚠ WARNING Risk of accident and injury due to children left unattended in the vehicle

If children are left unattended in the vehicle, they could:

- open doors, thereby endangering other persons or road users.
- get out of the vehicle and be hit by oncoming traffic.
- operate vehicle equipment and become trapped, for example.

In addition, children could also set the vehicle in motion, for example, by:

- releasing the parking brake.
- shifting the automatic transmission out of park position **P** or shifting manual transmission into neutral.
- starting the engine.

- ▶ When leaving the vehicle, always take the key with you and lock the vehicle.
- ▶ Never leave children and animals unattended in the vehicle.
- ▶ Keep the vehicle key out of reach of children.

If the vehicle does not start and the display message **Place the key in the marked space** See *Owner's Manual* appears in the multifunction display, you can start the vehicle in emergency operation mode.

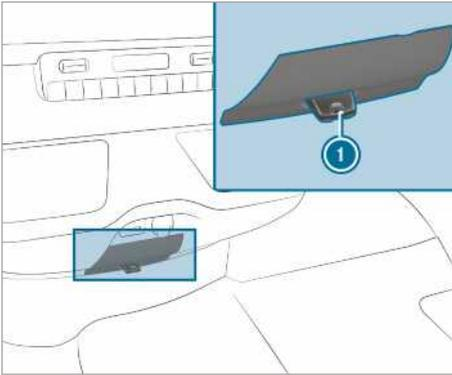

- ▶ Remove the key ① from your key ring.
- ▶ Insert the key ① in the slot.
The vehicle is started after a brief time.
- ▶ Leave the key inserted during the entire journey.
- ▶ If you pull the key ① out of the slot, the engine continues to run.
- ▶ Have the key ① checked at a qualified specialist workshop.

If the vehicle does not start:

- ▶ leave the key ① in the slot.
 - ▶ **Vehicles with manual transmission:**
depress the clutch pedal.
 - ▶ **Vehicles with automatic transmission:**
depress the brake pedal.
 - ▶ Start the vehicle with the start/stop button.
- ① You can also switch on the power supply or the ignition with the start/stop button.

Running-in notes

Protect the engine during the first 1,500 km by:

- driving at varying road and engine speeds.
- shifting to the next gear up when or before the rev counter needle is $\frac{2}{3}$ of the way to the red area.
- avoiding stress on the vehicle such as driving at full throttle.
- not shifting manually to a lower gear to brake.
- after 1,500 km, gradually increasing the engine speed and accelerate the vehicle up to full speed.

- **vehicles with automatic transmission:** not depressing the accelerator pedal beyond the pressure point (kickdown).

This also applies if the engine or parts of the drivetrain have been replaced.

Also observe the following running-in notes:

- The sensors of the ESP® driving safety system adjust automatically while a certain distance is being driven after the vehicle has been delivered or after repairs. Full system effectiveness is not reached until the end of this teach-in process.
- New or exchanged brakepads, brake discs and tyres only provide optimal braking and bonding after several hundred kilometres. Until then, compensate for the reduced braking effect by applying greater pressure to the brake pedal.

Driving tips

Notes on driving

- ⚠ WARNING** Risk of accident due to objects in the driver's footwell

Objects in the driver's footwell may impede pedal travel or block a depressed pedal.

This jeopardises the operating and road safety of the vehicle.

- ▶ Stow all objects in the vehicle securely so that they cannot get into the driver's footwell.
- ▶ Ensure floor mats and carpets cannot slip and provide sufficient room for the pedals.
- ▶ Do not lay multiple floor mats or carpets on top of one another.

- ⚠ WARNING** Risk of accident due to unsuitable footwear

Operating the pedals may be impaired by wearing unsuitable footwear, e.g.:

- platform shoes
 - high-heeled shoes
 - slippers
- ▶ Always wear suitable footwear when driving so that you can operate the pedals safely.

⚠ WARNING Risk of accident when the ignition is switched off due to steering wheel lock

If you switch off the ignition while the vehicle is at a standstill, the steering wheel lock engages in vehicles with manual transmission.

You can no longer steer the vehicle.

- ▶ Turn on the ignition before rolling the vehicle to deactivate the steering wheel lock.

⚠ WARNING Risk of accident when switching off the ignition when driving

If you switch off the ignition while driving, safety functions are restricted or no longer available. This may affect the power steering system and the brake force boosting, for example.

You will then need to use considerably more force to steer and brake.

- ▶ Do not switch off the ignition while driving.

⚠ DANGER Risk of fatal injuries due to exhaust gases

Combustion engines emit poisonous exhaust gases such as carbon monoxide. Inhaling these exhaust gases is hazardous to health and can lead to poisoning.

- ▶ Never leave the engine running in an enclosed space without sufficient ventilation.

⚠ DANGER Risk of fatal injuries due to poisonous exhaust gases

If the tailpipe is blocked or sufficient ventilation is not possible, poisonous exhaust gases such as carbon monoxide may enter the vehicle. This is the case, for example, if the vehicle is stuck in snow.

- ▶ When the engine or the stationary heater are running, keep the tailpipe and the area around the vehicle clear of snow.
- ▶ Open a window on the side of the vehicle facing the wind to ensure an adequate supply of fresh air.

⚠ WARNING Risk of accident due to overheated brake system

If you rest your foot on the brake pedal during while driving, the brake system may overheat. This increases the braking distance and the brake system may even fail.

- ▶ Never use the brake pedal as a footrest.
- ▶ Do not press the brake pedal and accelerator pedal simultaneously while driving.

On long and steep downhill gradients, you should change down to a lower gear in good time. Take particular note of this when driving a laden vehicle. By doing so, you will make use of the engine's braking effect. This relieves the load on the brake system and prevents the brakes from overheating and wearing too quickly.

! NOTE Causing wear to the brake linings by permanently depressing the brake pedal

- ▶ Do not permanently depress the brake pedal while driving.
- ▶ To use braking effect of the engine, shift to a lower gear in good time.

! NOTE Damage to the drivetrain and engine when pulling away

- ▶ Do not warm up the engine while the vehicle is stationary. Pull away immediately.
- ▶ Avoid high engine speeds and driving at full throttle until the engine has reached its operating temperature.

! NOTE Damage to the catalytic converter due to non-combusted fuel

The engine is not running smoothly and is misfiring.

Non-combusted fuel may get into the catalytic converter.

- ▶ Only depress the accelerator pedal slightly.
- ▶ Have the cause rectified immediately at a qualified specialist workshop.

Information about short-distance trips

If the vehicle is predominantly used for short-distance driving, fuel may accumulate in the engine oil and cause engine damage.

Vehicles with a malfunction display (during short-distance trips)

If one of the following displays appears, drive at an engine speed of at least 2,000 rpm until the indicator lamp or the display message in the display disappears, at the earliest possible opportunity:

- the indicator lamp for the diesel particle filter in the instrument display lights up.
Observe the notes on regeneration (→ page 125).
- the **Exhaust filter Drive at high engine speeds** See *Owner's Manual* message appears on the multifunction display.

On vehicles with automatic transmission, shift to a lower gear (→ page 130).

Switch the ECO start/stop function off in vehicles with this function.

The diesel particulate filter's burn-off process is assisted by the intentional temperature increase.

If the indicator lamp or the display message does not go out after approximately 40 minutes, consult a qualified specialist workshop immediately.

Vehicles without a malfunction display (during short-distance trips)

If you mainly drive short distances, you should drive on a motorway or go for a country drive for 20 minutes every 500 km. This facilitates the regeneration of the diesel particulate filter.

Notes on the speed limitation

▲ WARNING Risk of injury through exceeding the specified tyre load-bearing capacity or the permissible speed rating

Exceeding the specified tyre load-bearing capacity or the permissible speed rating may lead to tyre damage and to the tyres bursting.

- ▶ Therefore, only use tyre types and sizes approved for your vehicle model.
- ▶ Observe the tyre load-bearing capacity rating and speed rating required for your vehicle.

As the driver, you must find out about the maximum permissible speed for the tyres (tyre and

tyre pressure). In particular, observe the legal requirements for tyres for the country you are in. You can permanently limit the speed of your vehicle.

Mercedes-Benz recommends a qualified specialist workshop for programming the speed limitation.

On vehicles with a limiter, you can temporarily or permanently limit the speed of your vehicle using the on-board computer (→ page 157).

Before overtaking, take into consideration that the engine speed limiter prevents the speed increasing beyond the programmed speed limitation.

On downhill gradients, the speed limitation may be exceeded. Apply the brakes if necessary.

Display messages indicate that you are approaching the limit speed.

Information about foreign trips**Service**

An extensive Mercedes-Benz service is also available abroad. Nevertheless, please remember that services or spare parts may not be available immediately. The relevant workshop directories are available from a Mercedes-Benz Service Centre.

Fuel

In some countries, only fuels with a low octane number or increased sulphur content are available.

Mercedes-Benz recommends installing a fuel filter with a water separator for countries with an increased water content in diesel.

Unsuitable fuel can cause engine damage. Information about fuel can be found in the "Fuel" section (→ page 350).

Information about transport by rail

Transporting your vehicle by rail may be subject to certain restrictions or require special measures to be taken in some countries due to varying tunnel heights and loading standards.

You can obtain information about this from any Mercedes-Benz Service Centre.

Notes on brakes

⚠ WARNING Risk of skidding and of an accident due to shifting down on slippery road surfaces

If you shift down on slippery road surfaces to increase the engine braking effect, the drive wheels may lose traction.

- ▶ Do not shift down on slippery road surfaces to increase the engine braking effect.

⚠ WARNING Risk of accident due to the brake system overheating

If you leave your foot on the brake pedal when driving, the brake system may overheat.

This increases the braking distance and the brake system may even fail.

- ▶ Never use the brake pedal as a footrest.
- ▶ Do not depress the brake pedal and the accelerator pedal at the same time while driving.

Downhill gradients

On long and steep downhill gradients you should observe the following instructions:

- in vehicles with an automatic transmission, shift down to shift ranges **2** or **1** in good time so that the engine is running at a medium to high engine speed (→ page 130).
- in vehicles with a manual transmission, shift down to a lower gear in good time, so that the engine is running at a medium to high engine speed.

i Change the shift range in good time when cruise control or the speed limiter are activated. Observe the driving tips (→ page 116).

You thereby make use of the braking effect of the engine and do not have to brake as often to maintain the speed. This relieves the load on the service brake and prevents the brakes from overheating and wearing too quickly.

Heavy and light loads

⚠ WARNING Risk of accident due to the brake system overheating

If you leave your foot on the brake pedal when driving, the brake system may overheat.

This increases the braking distance and the brake system may even fail.

- ▶ Never use the brake pedal as a footrest.
- ▶ Do not depress the brake pedal and the accelerator pedal at the same time while driving.

If the brakes have been subjected to a heavy load, do not stop the vehicle immediately. Drive on for a short while. The brakes cool down more quickly in the airflow.

If the brakes have been used only moderately, you should occasionally test their effectiveness. To do this, brake more firmly from a higher speed while paying attention to the traffic conditions. The brakes will grip better as a result.

Wet road surfaces

If you have been driving for a long time in heavy rain without braking, there may be a delayed response when you first apply the brakes. This may also occur after driving through a car wash or deep water. You must depress the brake pedal more firmly. Maintain a longer distance to the vehicle in front.

While paying attention to the traffic conditions, you should brake the vehicle firmly after driving on a wet road surface or through a car wash. This heats the brake discs so that they dry more quickly, which protects them against corrosion.

Limited braking effect on salt-treated roads:

- a layer of salt on the brake discs or brakepads can increase braking distances considerably, or braking may happen on only one side
- maintain an especially large safe distance to the vehicle in front

To remove the layer of salt:

- apply the brakes from time to time, paying attention to traffic conditions
- carefully depress the brake pedal at the end of a journey and after the start of a new journey

New brake discs and brakepads

New brakepads and brake discs only reach their optimal braking effect after approximately 100 km.

Until then, compensate for the reduced braking effect by applying greater pressure to the brake pedal. For safety reasons, Mercedes-Benz recommends that you only have brakepads and brake

discs which are approved by Mercedes-Benz installed on your vehicle.

Other brake discs or brakepads may compromise the safety of your vehicle.

Always replace all brake discs and brakepads on an axle at the same time. Always fit new brakepads when replacing brake discs.

Parking brake

▲ WARNING Risk of skidding or an accident by braking with the parking brake

If you have to brake your vehicle with the parking brake, the braking distance is considerably longer and the wheels may lock. There is an increased risk of skidding and/or accident.

- ▶ Only brake the vehicle with the parking brake if the service brake has failed.
- ▶ In this case, do not apply the parking brake with too much force.
- ▶ If the wheels lock, immediately release the parking brake as much as required for the wheels to turn again.

Vehicles with a manual parking brake

When driving on wet roads or dirt-covered surfaces, road salt or dirt may get into the parking brake. This causes corrosion and a reduction of braking force.

In order to prevent this, drive with the parking brake lightly applied from time to time.

When doing so, drive for a distance of approximately 100 m at a maximum speed of 20 km/h.

The brake lights do not light up when you brake the vehicle with the parking brake.

Information about driving on wet roads

Aquaplaning

▲ WARNING Risk of aquaplaning because tyre tread is too low

Depending on the depth of the water on the roadway, aquaplaning can occur despite sufficient tyre tread depth and low speed.

- ▶ Avoid tyre ruts and brake carefully.

Therefore, in heavy rain or other conditions in which aquaplaning can occur, drive as follows:

- reduce your speed.
- avoid tyre ruts.

- brake carefully.

Driving on flooded roads

Bear in mind that vehicles travelling in front or in the opposite direction create waves. This may cause the maximum permissible depth of water to be exceeded. These notes must be observed under all circumstances. Otherwise, you can damage the engine, electrics and transmission.

If you have to drive on stretches of road on which water has collected, please bear in mind the following:

- the water level of standing water may not be above the lower edge of the front bumper.
- you may drive no faster than walking pace.

Observe the notes on fording while off-road for all-wheel drive vehicles (→ page 121).

Information about driving in winter

▲ DANGER Risk of fatal injuries due to poisonous exhaust gases

If the tailpipe is blocked or sufficient ventilation is not possible, poisonous exhaust gases such as carbon monoxide may enter the vehicle. This is the case, for example, if the vehicle is stuck in snow.

- ▶ When the engine or the stationary heater are running, keep the tailpipe and the area around the vehicle clear of snow.
- ▶ Open a window on the side of the vehicle facing the wind to ensure an adequate supply of fresh air.

▲ WARNING Risk of skidding and of an accident due to shifting down on slippery road surfaces

If you shift down on slippery road surfaces to increase the engine braking effect, the drive wheels may lose traction.

- ▶ Do not shift down on slippery road surfaces to increase the engine braking effect.

Vehicles with automatic transmissions may roll in neutral position **[N]** for only a short time. Allowing the wheels to roll for longer, e.g. when towing, causes transmission damage.

If the vehicle threatens to skid, or cannot be stopped when travelling at a low speed, you can stabilise the vehicle using the following measures:

- shift the automatic transmission to neutral position **N**.
- shift the manual transmission into neutral or depress the clutch pedal.
- try to maintain control of the vehicle using corrective steering.

Drive particularly carefully on slippery roads. Avoid sudden acceleration, steering and braking manoeuvres.

Have your vehicle winterproofed at a qualified specialist workshop in good time at the onset of winter.

Observe the instructions in the section "Notes on snow chains" (→ page 312).

Regularly check the vehicle and remove snow or ice when travelling in wintry conditions.

An accumulation of snow and ice, particularly when frozen, in the area around the air intake, moving parts, the axles and the wheel housing, may cause the following problems:

- obstruction of the air intake
- damage to vehicle parts
- malfunctions due to restriction of mobility intended by the design (e.g. reduced steering movement)

If there is any damage, inform a qualified specialist workshop.

Information about driving off-road

⚠ WARNING Risk of accident if you do not keep to line of fall on inclines

If you drive at an angle or turn on an incline, the vehicle could slip sideways, tip and roll-over.

- ▶ Always drive on inclines in the line of fall (straight up or down) and do not turn.

⚠ WARNING Risk of injury due to accelerating force during off-road driving

When driving off-road on uneven surfaces, the force of the vehicle's acceleration affects your body from all directions.

You could, for example, be thrown from your seat.

- ▶ Always wear a seat belt when driving off-road.

⚠ WARNING Risk of injury to the hands when driving over obstacles

If you drive over obstacles or in tyre ruts, the steering wheel may whip around and cause injuries to the hands.

- ▶ Steering wheel must always be held securely with both hands.
- ▶ When driving over obstacles, expect increased steering forces at short notice.

⚠ WARNING Risk of fire due to flammable materials on hot parts of the exhaust system

Flammable material such as leaves, grass or twigs may ignite if they come into contact with hot parts of the exhaust system.

- ▶ When driving on unpaved roads or off-road, regularly check the vehicle underside.
- ▶ Remove trapped plants or other flammable material, in particular.
- ▶ If there is damage, consult a qualified specialist workshop immediately.

ℹ NOTE Damage to the vehicle after driving off-road

When driving off-road or on unpaved surfaces, foreign bodies such as stones and branches could become trapped on the vehicle underside, on wheels and tyres, causing damage to the vehicle.

Foreign bodies could cause the following damage:

- damage the suspension, the fuel tank or the brake system.
- disturb the balance and cause vibrations.
- ▶ Regularly remove any trapped foreign bodies, e.g. stones and branches.
- ▶ After driving off-road, check carefully whether there is any damage to the vehicle.
- ▶ If there is damage, have the vehicle checked at a qualified specialist workshop.

When driving off-road or on unpaved surfaces, check the vehicle underside, wheels and tyres regularly at regular intervals. In particular, remove any trapped foreign bodies, e.g. stones and branches.

Observe the following notes regarding foreign bodies of this kind:

- They may damage the suspension, the fuel tank or the brake system.
- They may disturb the balance and cause vibrations.
- They may be flung out from the vehicle when you continue driving.

If there is any damage, inform a qualified specialist workshop.

When driving off-road on steep inclines, you must make sure that the AdBlue® tank is sufficiently filled. Therefore, ensure a level of at least ten litres before off-road driving.

When driving off-road and on construction sites, sand, mud and water, also mixed with oil, can get into the brakes. This may lead to a reduction in braking effect or total brake failure, also as a result of increased wear. The braking characteristics will vary depending on the material that has got into the system. Clean the brakes after driving off-road. If you then notice a reduced braking effect or hear scraping noises, have the brake system checked immediately at a qualified specialist workshop. Adjust your driving style to the changed braking characteristics.

Driving off-road or on construction sites increases the possibility of vehicle damage which may in turn lead to the failure of certain major assemblies and systems. Adapt your driving style to the off-road driving conditions. Drive carefully. Have any vehicle damage rectified at a qualified specialist workshop as soon as possible.

When driving on rough cross-country terrain, do not shift the transmission into the neutral position and do not disengage the clutch. You could lose control when attempting to brake the vehicle with the service brake. If your vehicle cannot manage an uphill incline, drive back down in reverse gear.

When loading your vehicle for off-road driving or on a construction site, keep the vehicle's centre of gravity as low as possible.

Checklist before off-road driving

- Check the fuel and AdBlue® levels (→ page 180) and top up if necessary (→ page 139).
- **Engine:** check the oil level and top up with oil if necessary (→ page 281). Before driving up or down extreme inclines or slopes, fill the oil to the maximum level.
- **i** If you drive up or down extreme inclines or slopes, the  symbol may appear in the multifunction display. The engine operating safety is not put at risk if you have filled the engine oil to the maximum level before the journey.
- **Vehicle tool kit:** check that the jack is working (→ page 334).
- Make sure that a wheel wrench (→ page 334), a wooden underlay for the jack, a robust tow rope, a folding spade and a wheel chock are carried in the vehicle.
- **Tyres and wheels:** check the tyre tread depth (→ page 311) and the tyre pressure (→ page 328).

Rules for off-road driving

Always be aware of the ground clearance of the vehicle and avoid obstacles such as deep tyre ruts.

Obstacles can damage the following parts of the vehicle, for example:

- suspension
- drivetrain
- fuel and supply tanks

Therefore, always drive slowly when off-road. If you must drive over obstacles, have the co-driver instruct you.

- **i** Mercedes-Benz recommends that you additionally carry a shovel and a recovery rope with a shackle in the vehicle.
- Make sure that loads and items of luggage are securely stored or lashed down (→ page 77).
- Before driving off-road, stop the vehicle and engage a low gear.
- **Vehicles with DSR:** activate DSR when you are driving downhill (→ page 134).
- **All-wheel drive vehicles:** activate the all-wheel drive (→ page 132) and, if necessary, activate the LOW RANGE transmission ratio (→ page 133).

- If the surface requires, temporarily deactivate ASR when pulling away (→ page 132).
- Only drive off-road with the engine running and a gear engaged.
- Drive slowly and smoothly. Walking pace is necessary in many situations.
- Avoid spinning the driven wheels.
- Always ensure that the wheels remain in contact with the ground.
- Exercise the utmost caution when driving across unfamiliar, unpredictable terrain. As a precaution, get out of the vehicle to take a look at the route to be taken first.
- Look out for obstacles (e.g. rocks, holes, tree stumps and tyre ruts).
- Avoid edges where the surface could crumble or break away.

Rules for fording off-road (all-wheel drive vehicles)

- Observe the safety notes and general notes on driving off-road.
- Check the depth and characteristics of the body of water before fording. The water must not be deeper than 60 cm.
- The climate control system is switched off (→ page 103).
- The auxiliary heating is switched off (→ page 108).
- Switch on all-wheel drive (→ page 132) and engage it on vehicles with the LOW RANGE transmission ratio (→ page 133).
- Restrict the shift range to **1** or **2**.
- Avoid high engine speeds.
- Drive slowly and smoothly at no more than a walking pace.
- Ensure that no bow wave forms while driving.
- After fording, dry the brakes.

After driving through a body of water deeper than 50 cm, make sure to check all vehicle fluids for any signs of penetration by water.

Checklist after driving off-road

If you find damage to the vehicle after off-road driving, have the vehicle checked at a qualified specialist workshop immediately.

Driving over rough terrain places greater demands on your vehicle than normal road operation. Check your vehicle after driving on rough terrain. This allows you to detect damage

promptly and reduce the risk of an accident for yourself and other road users. Clean your vehicle thoroughly before driving on public roads.

Observe the following points after driving off-road, on construction sites and before driving on public roads:

- **Vehicles with DSR:** deactivate DSR (→ page 134).
- **All-wheel drive vehicles:** deactivate the all-wheel drive (→ page 132).
- Activate ASR (→ page 132).
- Clean the exterior lighting, particularly the headlamps and tail lamps, and check them for damage.
- Clean the front and rear licence plates.
- Clean the windscreen, windows and outside mirrors.
- Clean the steps, entrances and grab handles. This increases the safety of your footing.
- Clean the wheels and tyres, wheel wells and the underbody of the vehicle with a water jet. This increases road adhesion, especially on wet roadways.
- Check the wheels and tyres and wheel wells for trapped foreign objects and remove them. Trapped foreign objects can damage the wheels and tyres or may be flung out from the vehicle when continuing the journey.
- Check the underbody for trapped branches or other parts of plants and remove them.
- Clean the brake discs, brakepads and axle joints, particularly after operation in sand, mud, grit and gravel, water or similarly dirty conditions.
- Check the entire floor assembly, the tyres, wheels, bodywork structure, brakes, steering, suspension and exhaust system for any damage.
- Check the service brake for operating safety, e.g. carry out a brake test.
- If you notice strong vibrations after driving off-road, check the wheels and drivetrain for foreign objects again. Remove any foreign objects which can lead to imbalances and thus cause vibrations. In the event of damage to the wheels and the drive train, visit a qualified specialist workshop immediately.

Information about driving in mountainous areas

Vehicles with diesel engines: the operating safety of the diesel engine is guaranteed up to an altitude of 2,500 m above sea level. You may exceed this height for a short time, e.g. in mountainous terrain. Do not drive continuously at altitudes above 2,500 m. Otherwise, you may damage the diesel engine.

When driving in mountainous areas, note that the engine power, and therefore its gradient-climbing capability, decrease with increasing altitude. The ECO Start function is no longer available when driving at altitudes of 2,500 m above sea level. Notes on braking on downhill gradients can be found in Notes on braking (→ page 119).

ECO start/stop function

ECO start/stop function operation

The engine is switched off automatically if the following conditions are met:

- **Vehicles with manual transmission:** you decelerate the vehicle to a lower speed, then engage neutral **[N]** and then release the clutch pedal.
- **Vehicles with automatic transmission:** you stop the vehicle in transmission position **[D]** or **[N]**.
- All on vehicle conditions for automatic engine stop are met.

When stationary, the **[A]** symbol appears in the multifunction display. If all on vehicle conditions are not met, the **[A]** symbol appears in the multifunction display.

The engine restarts automatically in the following cases:

- **Vehicles with manual transmission:** you depress the clutch pedal.
- **Vehicles with manual transmission:** you engage reverse gear **[R]**.
- **Vehicles with automatic transmission:** you release the brake pedal in transmission position **[D]** and with the HOLD function deactivated.
- **Vehicles with automatic transmission:** you shift out of transmission position **[P]**.
- **Vehicles with automatic transmission:** you select transmission position **[D]** or **[R]**.
- you depress the accelerator pedal.

- an on vehicle automatic engine start is required.

If the engine was switched off by the ECO start/stop function and you leave the vehicle, a warning tone sounds. Additionally, the **Vehicle is operational Switch off the ignition before exiting** display message appears in the multifunction display. If you do not switch off the ignition, the ignition is automatically deactivated after one minute.

Switching the ECO start/stop function off/on

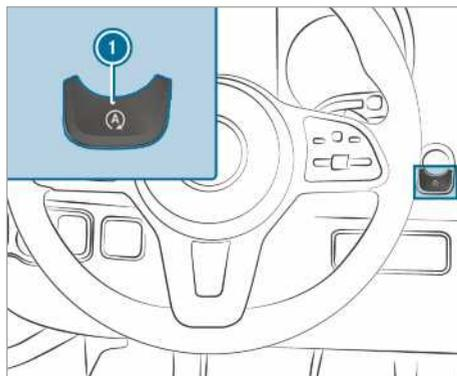

- ▶ Press the **1** button. A display appears in the instrument cluster when the ECO start/stop function is switched off or on.
- ⓘ When the vehicle is stationary, a display appears in the instrument cluster while the ECO start/stop function is switched off.

ECO display function

The ECO display summarises the driving characteristics from the start of the journey to its completion and assists you in achieving the most economical driving style.

You can influence consumption if you:

- anticipate road and traffic conditions.
- observe the gearshift recommendations.

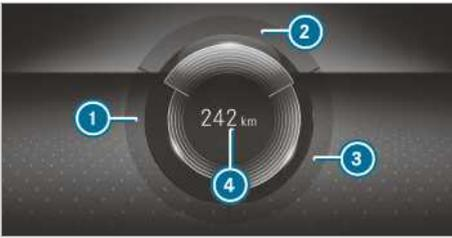

Instrument display with colour display

The segment's lettering lights up bright, the outer edge lights up and the segment is filled, in the following cases:

- ① **ACCELERATION**: moderate acceleration
- ② **CONSTANT**: consistent speed
- ③ **COASTING**: gentle deceleration and rolling

The segment's lettering is grey, the outer edge is dark and the segment is emptied, in the following cases:

- ① **ACCELERATION**: sporty acceleration
- ② **CONSTANT**: fluctuations in speed
- ③ **COASTING**: heavy braking

You have driven economically when:

- the three segments fill up completely at the same time
- the edge around all three segments lights up

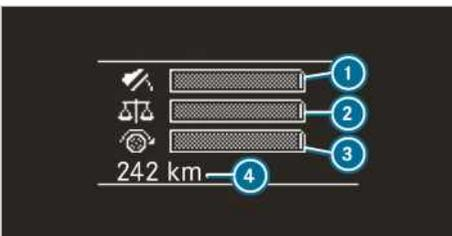

Instrument display with black and white display

The bars fill up in the following cases:

- ① Moderate acceleration
- ② Consistent speed
- ③ Gentle deceleration and rolling

The bars empty in the following cases:

- ① Sporty acceleration
- ② Fluctuations in speed

- ③ Heavy braking

The display shows the additional range ④ **Bonus XXX miles From start** or **XXX miles From start** achieved as a result of your driving style in comparison to a driver with a very sporty driving style. The range displayed does not indicate a fixed reduction in consumption.

Diesel particulate filter

Notes on regeneration

⚠ DANGER Risk of fatal injuries due to exhaust gases

Combustion engines emit poisonous exhaust gases such as carbon monoxide. Inhaling these exhaust gases is hazardous to health and can lead to poisoning.

- ▶ Never leave the engine running in an enclosed space without sufficient ventilation.

⚠ WARNING Risk of fire caused by hot exhaust system parts

Flammable material such as leaves, grass or twigs may ignite if they come into contact with hot parts of the exhaust system or exhaust gas flow.

- ▶ Park the vehicle so that no flammable material can come into contact with hot vehicle components.
- ▶ In particular, do not park on dry grassland or harvested grain fields.

If the vehicle is predominantly used for short-distance driving or power take-off is used when stationary, it could lead to malfunctions in the automatic cleaning function of the diesel particulate filter. The diesel particulate filter may become overloaded causing loss of engine power.

- ① If your vehicle has a particulate filter load display or a regeneration display, you can display this in the multifunction display. If necessary, you can request regeneration of the diesel particulate filter via the regeneration display. (→ page 126)
- ① Regular regeneration of the diesel particulate filter can prevent malfunctions, thinning of the engine oil and loss of engine power.

NOTE Damage due to hot exhaust gases

During regeneration, extremely hot exhaust gases escape from the tailpipe.

- ▶ During regeneration, maintain a minimum distance of 2 m from other objects, e.g. parked vehicles.

Starting and cancelling regeneration**Requirements:**

- all system requirements have been met.
- the load condition of the diesel particulate filter is above 50 %.
- the vehicle is being driven.

- ⓘ If your vehicle is equipped with a diesel particulate filter load display or a regeneration display, you can view this via the multifunction display. If necessary, you can request regeneration of the diesel particulate filter via the regeneration display. (→ page 126)

On-board computer:

↳ Service ▶ Particle filter

NOTE Damage due to hot exhaust gases

During regeneration, extremely hot exhaust gases escape from the tailpipe.

- ▶ During regeneration, maintain a minimum distance of 2 m from other objects, e.g. parked vehicles.

If the vehicle is used under normal operating conditions, it is not necessary to additionally request regeneration.

- ▶ Select **Request regeneration: OK**. The **Manual regeneration requested** message appears.

Depending on the operating status and the ambient conditions, it can take up to 20 minutes until regeneration starts.

The **Regeneration active** message appears when regeneration starts. Regeneration lasts approx. 15 minutes.

- ▶ During regeneration, drive with an engine speed of at least 2000 rpm, as far as is possible.

The temperature increase generated helps support the diesel particulate filter's burn-off process.

- ▶ **To cancel regeneration:** switch off the engine.

Regeneration is cancelled. If regeneration is not completed, you can restart regeneration after starting the engine.

Depending on the load condition of the diesel particulate filter, regeneration starts automatically when next driving.

Battery main switch**Notes on the battery main switch****NOTE** Damage to the electrical system

If you remove or disconnect the battery main switch, it could lead to the electrical system becoming damaged.

- ▶ Make sure that the ignition is switched off and that at least 15 minutes have passed before removing or reconnecting the battery main switch. Otherwise, electrical system components could be damaged.

You can use the battery main switch to disconnect the current to all your vehicle's consumers. This will prevent uncontrolled battery discharge caused by quiescent current consumers.

If your vehicle is equipped with an auxiliary battery in the engine compartment or in the base of the co-driver's seat, you must disconnect both batteries. Only then is the electrical system fully disconnected from the power supply.

- ⓘ Only disconnect the vehicle from the power supply using the battery main switch in the following situations:

- the vehicle is stationary for a long time
- it is absolutely necessary to disconnect the vehicle from the power supply

After switching on the power supply, you will need to reset the side windows (→ page 58) and the electric sliding door (→ page 53).

- ⓘ A break in the power supply is entered in the DTCO (digital tachograph) as an event in the fault memory. See the separate DTCO operating instructions.

Switching the power supply on/off

Switching off the power supply

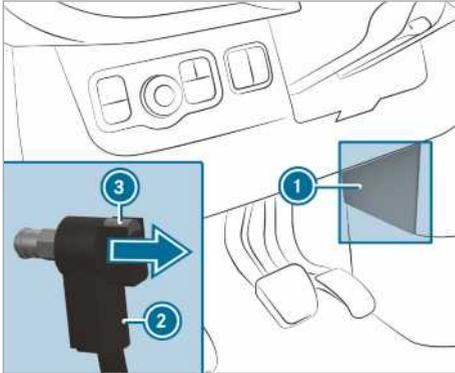

- ▶ Switch off the ignition and wait at least 15 minutes.
- ▶ Remove cover ①.
- ▶ Press and hold button ③.
- ▶ Pull plug ② out of the earth pin.
- ▶ Push plug ② as far as possible in the direction of the arrow so that it cannot make contact with the earth pin.
All starter battery consumers are disconnected from the power supply.

Switching on the power supply

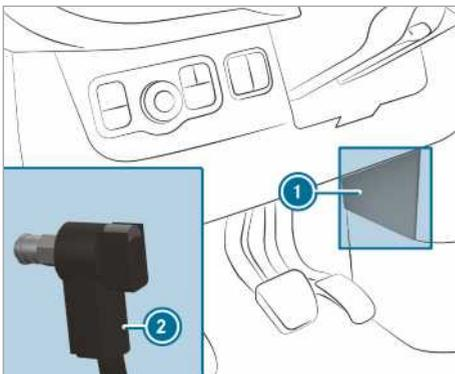

- ▶ Press plug ② onto the earth pin until you feel it engage and plug ② is in full contact with the earth pin.
All starter battery consumers are reconnected to the power supply.
- ▶ Fasten cover ①.

Manual transmission

Using the gearshift lever

- ❗ **NOTE** Damage to the engine and transmission by shifting to a gear that is too low

- ▶ When changing between gears ⑤ and ⑥ push the gearshift lever to the right.
- ▶ Do not shift down at high speeds.

- ❗ **NOTE** Damage to the transmission by shifting to reverse gear [R] while the vehicle is in motion

- ▶ Only shift into reverse gear [R] when the vehicle is stationary.

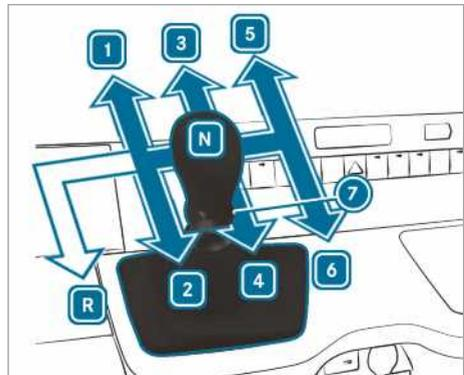

Vehicles with rear wheel drive

- [R] Reverse gear
- [1] - [6] Forward gears
- ⑦ Reverse gear pull ring
- [N] Neutral

- ▶ Depress the clutch pedal and move the gearshift lever to the desired position.

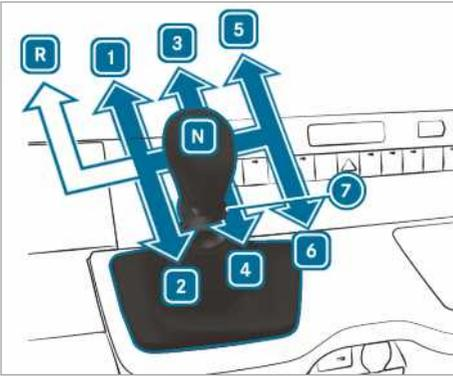

Vehicles with front wheel drive

- R** Reverse gear
- 1** - **6** Forward gears
- 7** Reverse gear pull ring
- N** Neutral

▶ Depress the clutch pedal and move the gear-shift lever to the desired position.

Gearshift recommendation

The gearshift recommendation provides instructions for a fuel-saving driving style.

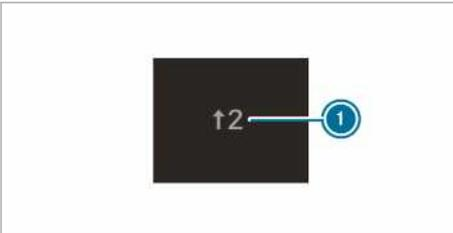

Example image

▶ If the gearshift recommendation **1** appears on the multifunction display, shift to the recommended gear.

i In vehicles with an ECO start/stop function, a gearshift recommendation to switch to neutral **N** is displayed as well.

Automatic transmission

DIRECT SELECT lever

Function of the DIRECT SELECT lever

⚠ WARNING Risk of accident and injury due to children left unattended in the vehicle

If children are left unattended in the vehicle, they could:

- open doors, thereby endangering other persons or road users.
- get out of the vehicle and be hit by oncoming traffic.
- operate vehicle equipment and become trapped, for example.

In addition, children could also set the vehicle in motion, for example, by:

- releasing the parking brake.
- shifting the automatic transmission out of park position **P**.
- starting the engine.

▶ Never leave children and animals unattended in the vehicle.

▶ When leaving the vehicle, always take the key with you and lock the vehicle.

▶ Keep the key out of the reach of children.

⚠ WARNING Risk of accident due to incorrect gearshifting

If the engine speed is higher than the idle speed and you engage the transmission position **D** or **R**, the vehicle may accelerate sharply.

▶ If you engage the transmission position **D** or **R** always depress the brake pedal firmly and do not accelerate at the same time.

You use the DIRECT SELECT lever to switch the transmission position. The current transmission position appears in the multifunction display.

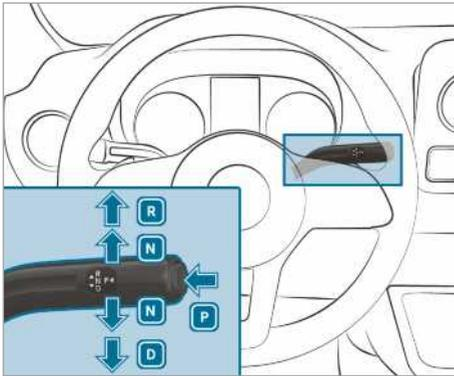

- P** Park position
- R** Reverse gear
- N** Neutral
- D** Drive position

Engaging reverse gear R

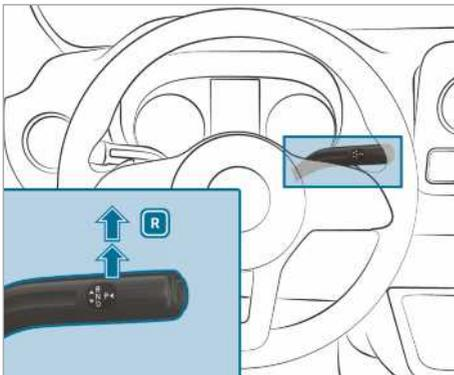

- ▶ Depress the brake pedal and push the DIRECT SELECT lever upwards past the first point of resistance. Transmission position display **R** is shown in the multifunction display.

Selecting neutral N

⚠ WARNING Risk of accident and injury when neutral position engaged

The vehicle can roll away if the parking brake is not applied and you park the vehicle with the neutral position **N** engaged.

There is a risk of accident and injury.

- ▶ Before parking the vehicle, apply the parking brake.

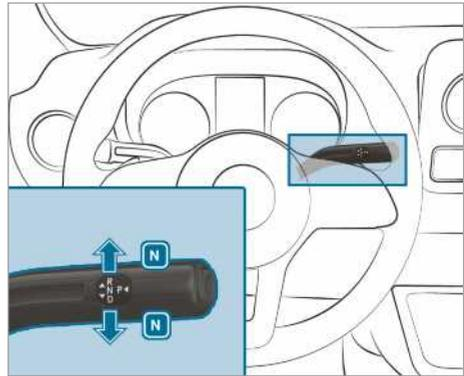

- ▶ Press the brake pedal and the DIRECT SELECT lever upwards or downwards to the first point of resistance. Transmission position display **N** is shown in the multifunction display.

Releasing the brake pedal will allow you to move the vehicle freely, e.g. to push it or tow it.

If the automatic transmission should also stay in neutral **N when the ignition is switched off, carry out the following:**

- ▶ start the vehicle.
 - ▶ depress the brake pedal and shift to neutral **N**.
 - ▶ release the brake pedal.
 - ▶ switch off the ignition.
- i** If you then leave the vehicle and the key is still in the vehicle, the automatic transmission will stay in neutral **N** from then on.

Engaging park position P

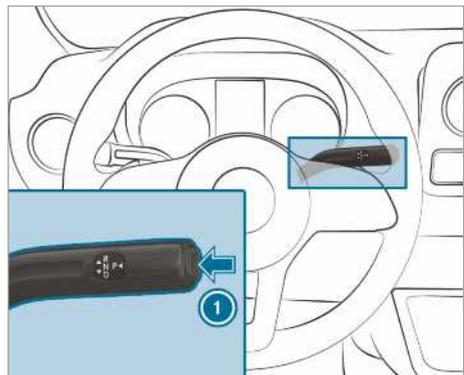

▶ Press button ①.

Transmission position display **P** is shown in the multifunction display.

Park position **P** is engaged automatically when one of the following conditions is met:

- you switch off the engine in transmission position **D** or **R**.
- you open the driver's door when the vehicle is stationary or when driving at a very low speed and in transmission position **D** or **R**.
- you open the seat belt buckle when the vehicle is stationary or when driving at a very low speed.
- you leave your seat when the vehicle is stationary or when driving at a very low speed.

Engaging drive position D

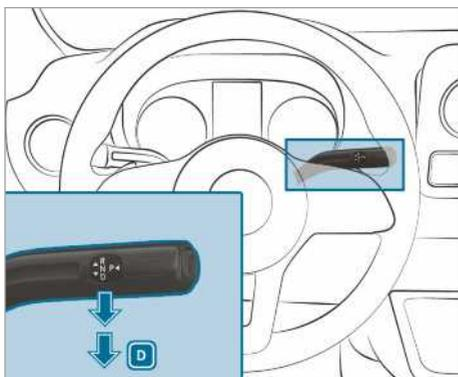

- ▶ Depress the brake pedal and push the DIRECT SELECT lever downwards past the first point of resistance. Transmission position display **D** is shown in the multifunction display.

The automatic transmission shifts through the individual gears automatically when it is in transmission position **D**. This is determined by the following factors:

- position of the accelerator pedal
- driving speed

Restricting the shift range

Requirements:

- transmission position **D** is engaged (→ page 130).

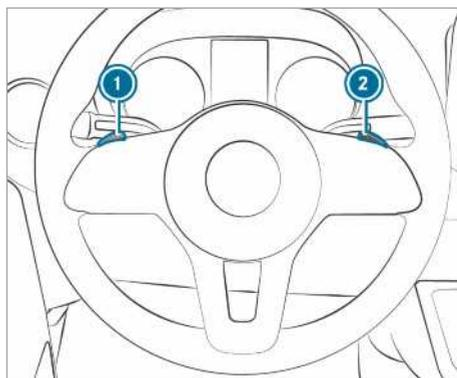

- ▶ **To restrict the shift range:** briefly pull the steering wheel gearshift paddle ①. The automatic transmission shifts to the next gear down, depending on the gear currently engaged. The shift range is also restricted. The shift range selected is shown in the multifunction display. The automatic transmission shifts only as far as the selected gear.
- ▶ Pull and hold the steering wheel gearshift paddle ①. The automatic transmission will change to a shift range which allows easy acceleration and deceleration. To do this, the automatic transmission shifts down one or more gears and restricts the shift range. The shift range selected is shown in the multifunction display. The automatic transmission shifts only as far as the selected gear.

- ⓘ The automatic transmission does not shift down if you pull the steering wheel gearshift paddle ① whilst travelling at too high a speed. If the shift range is restricted and the maximum engine speed for the restricted shift range is reached, the automatic transmission will not shift up.

- ▶ **To derestrict the shift range:** briefly pull the steering wheel gearshift paddle ②. The automatic transmission shifts to the next gear up, depending on the gear currently engaged. This derestricts the shift range at the same time. The shift range selected is shown in the multifunction display. The automatic transmission shifts only as far as the selected gear.
- ▶ **To derestrict the shift range:** pull and hold the steering wheel gearshift paddle ②.

or

- ▶ engage transmission position **D** again (→ page 130).
The automatic transmission shifts up one or more gears depending on the gear currently engaged. Simultaneously, the shift range restriction is deactivated and the transmission position appears in the multifunction display **D**.

Adapting the shift range to the driving situation:

- 3** Use the engine's braking effect.
- 2** Use the engine's braking effect on downhill gradients and when driving on steep roads, in mountainous areas as well as under arduous operating conditions.
- 1** Use the engine's braking effect on extremely steep downhill gradients and on long downhill stretches.

Using kickdown

- ▶ **For maximum acceleration:** depress the accelerator pedal beyond the pressure point.
- ▶ Ease off the accelerator pedal once the desired speed is reached.

Deactivating the park pawl manually (vehicles with front wheel drive)

- i** **Vehicles with automatic transmission and front wheel drive:** in the event of damage to the electrics, the automatic transmission may be locked in position **P**. In this case the park pawl can be deactivated mechanically, e.g. to tow away the vehicle (→ page 303).
- i** Mechanical park pawl deactivation is only possible on automatic vehicles with front wheel drive.

Requirements:

- you require the release tool from the vehicle tool kit (→ page 309).

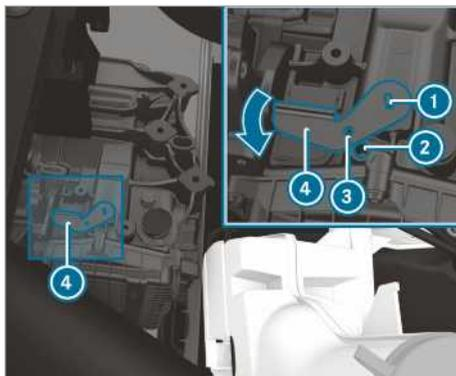

- ▶ Apply the parking brake.
- ▶ Open the bonnet (→ page 278).
- ▶ Attach the release tool **4** to the transmission **1** and turn in the direction of the arrow.
- ▶ Insert a suitable tool, e.g. a screwdriver, through the hole on the release tool **3** and into the transmission **2**.
The release tool **4** is securely in position. The park pawl is deactivated.
- ▶ Position **P** cannot be engaged while release tool **4** is attached to the transmission.
- ▶ Observe the notes on towing away (→ page 303).
- i** When release tool **4** is removed, the transmission automatically springs back to position **P**.

All-wheel drive

Notes on all-wheel drive

All-wheel drive ensures permanent drive for all four wheels, and together with ESP® it improves the traction of the vehicle.

The traction control of the all-wheel drive also takes place via the brake system. Therefore, the brake system can overheat during extreme off-road use. In this case, ease off the accelerator pedal or stop to allow the brake system to cool down.

If a driven wheel spins due to insufficient traction, observe the following notes:

- when pulling away, make use of the traction control integrated in ESP®. Depress the accelerator pedal as far as necessary.

- take your foot off the accelerator pedal, slowly, while the vehicle is in motion.

In wintry driving conditions, always use winter tyres (M+S tyres) and, if necessary, snow chains (→ page 312). Only in this way can the maximum effect of all-wheel drive be achieved.

Use DSR (Downhill Speed Regulation) when driving downhill off-road (→ page 134).

If you fail to adapt your driving style or if you are inattentive, the all-wheel drive system can neither reduce the risk of an accident nor override the laws of physics. The all-wheel drive system cannot take road, weather and traffic conditions into account. The all-wheel drive system is only an aid. You are responsible for maintaining a safe distance from the vehicle in front, for vehicle speed, for braking in good time and for staying in lane.

! **NOTE** Risk of damage to the drivetrain and the brake system

If you operate vehicles with all-wheel drive on a one-axle test stand, you may damage the drivetrain or the brake system.

- ▶ A function or performance test should only be carried out on a two-axle test stand.
- ▶ If you wish to operate the vehicle on such a test stand, please consult a qualified specialist workshop in advance.

! **NOTE** Risk of damage to the transfer case

If you tow the vehicle with a raised axle, the transfer case can get damaged. Such damage is not covered by Mercedes-Benz implied warranty.

- ▶ Never tow the vehicle with a raised axle.
- ▶ Only tow the vehicle with all wheels on the ground or fully raised.
- ▶ Note the instructions on towing the vehicle with full contact with the ground for all wheels.

Engaging all-wheel drive

Conditions for engaging/disengaging

You can engage and deactivate the all-wheel drive when stationary or while driving slowly.

When stationary, the following must be observed:

- the engine is running.
- the steering wheel in the straight-ahead position.

If the all-wheel drive cannot be engaged when stationary:

▶ **vehicles with manual transmission:**

depress the clutch pedal.

▶ **vehicles with automatic transmission:**

shift the selector lever from **[N]** to **[D]** from **[D]** to **[N]** from **[N]** to **[R]** and back to **[N]**.

Engaging and disengaging the all-wheel drive can be made easier in this way.

Observe the following when driving slowly:

- the engine is running.
- the vehicle is not travelling faster than 10 km/h.
- the vehicle is not being driven around a bend.

If it is not possible to engage all-wheel drive when the vehicle is rolling:

▶ **vehicles with manual transmission:**

depress the clutch pedal.

▶ **vehicles with automatic transmission:**

briefly move the selector lever to **[N]**.

- ⓘ If you engage the all-wheel drive, the variable limiter deactivates automatically. The corresponding display message is not shown. You must activate the variable limiter again after disengaging the all-wheel drive if necessary (→ page 158).

Engaging/disengaging all-wheel drive

! **NOTE** Risk of damage to the transfer case

If you step on the accelerator pedal while the all-wheel drive is engaged or disengaged, the transfer case may be damaged.

- ▶ Do not step on the accelerator pedal when the indicator lamp in the switch for the all-wheel drive is flashing.

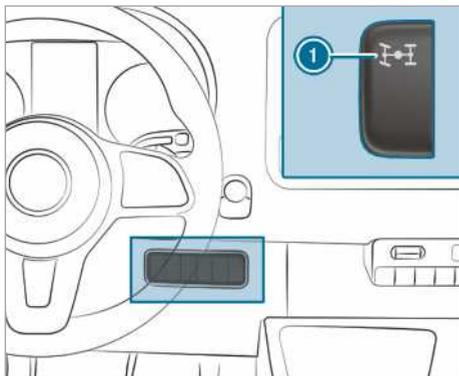

► **To engage/disengage:** press the upper section of switch ①.

The indicator lamp in the switch ① flashes while the all-wheel drive is engaged or disengaged.

The  and  warning lamps light up in the instrument display. ESP® and ASR are deactivated for the duration of the shift operation. If the shift operation is successful, the  and  warning lamps in the instrument display go out and ESP® and ASR are reactivated.

As long as the indicator lamp in the switch ① is flashing, you can cancel the shift operation by pressing switch ① again. If the shift operation fails, the indicator lamp in the switch ① briefly flashes three times. One of the shift conditions was not met.

If the indicator lamp in the switch ① lights up, all-wheel drive is engaged. A relevant message appears in the display of the on-board computer.

ⓘ If the LOW RANGE gear reduction is engaged, the all-wheel drive cannot be disengaged.

Function of the LOW RANGE gear reduction

The LOW RANGE gear reduction enables very slow driving in the respective gears. If you engage LOW RANGE, the engine's performance characteristics and the automatic transmission's shifting characteristics are adjusted accordingly. The transmission ratio from the engine to the wheels is around 40% lower than in the road position. The drive torque is increased correspondingly.

Conditions for engaging/disengaging

The following shifting conditions must be met in order to engage or disengage LOW RANGE:

- all-wheel drive is engaged (→ page 132).
- the engine is running.
- the vehicle is stationary.
- you depress the brake pedal.
- **vehicles with manual transmission:** the manual transmission is in neutral.
- **vehicles with automatic transmission:** the selector lever is in position  or .

Engaging and disengaging LOW range

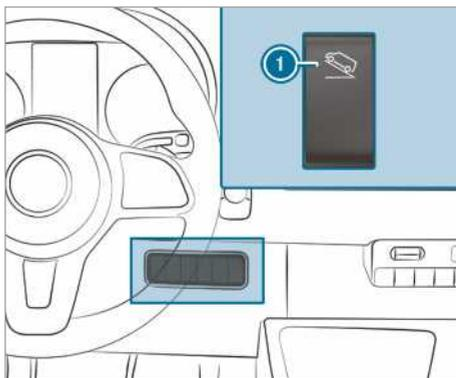

① Engaging and disengaging LOW range

ⓘ On vehicles with DSR (Downhill Speed Regulation), the switch ① is replaced with the switch for DSR.

► **To engage and disengage:** press the upper section of switch ①.

The  indicator lamp flashes in the instrument display for the duration of the shift operation.

- When the shift operation takes place and LOW RANGE is engaged, the  indicator lamp lights up.
- When the shift operation takes place and LOW RANGE is disengaged, the  indicator lamp goes out.

As long as the indicator lamp  is flashing, you can cancel the shift operation by pressing button ① again. If the shift operation fails, the indicator lamp  briefly flashes three times. One of the shift conditions was not met.

DSR (Downhill Speed Regulation)

Notes on DSR

If you fail to adapt your driving style or you are inattentive, DSR can neither reduce the risk of accident nor override the laws of physics. DSR cannot take road, weather and traffic conditions into account. DSR is only an aid. You are responsible for a safe distance to the vehicle in front, for vehicle speed and for braking in good time.

DSR supports you when driving downhill. DSR maintains a set speed for you on downhill gradients by applying the brakes as required. Maintaining the speed is dependent on the road surface conditions and the downhill gradient and cannot therefore be guaranteed in all situations.

You can set the speed depending on the gear range to between 4 km/h and 18 km/h using the brake and accelerator pedals or the rocker switch on the steering wheel.

DSR automatically controls in the following situations:

- if the vehicle is stationary, or its speed is less than 4 km/h, the speed is set to 4 km/h or it is set to the minimum speed for the respective gear range.
- if you drive faster than 18 km/h off-road, DSR switches to standby mode. DSR remains activated, but does not brake automatically.
- if you drive downhill slower than 18 km/h, DSR sets the speed to the previously set speed.
- if you drive faster than 45 km/h, DSR switches off automatically.

Activating/deactivating DSR

Activating DSR

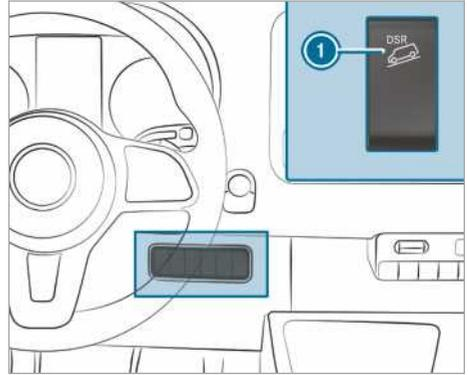

You can activate DSR when the vehicle is stationary or moving.

- ▶ Press the upper section of switch ①.
- ▶ Brake or accelerate the vehicle to the desired speed between 4 km/h and 18 km/h.
- ▶ Release the brake or accelerator pedal. The current speed is stored. When stationary, 4 km/h or the minimum possible speed for each gear range is stored. DSR maintains the stored speed on the downhill gradient and brakes automatically.

When DSR is activated and the vehicle pulls away, accelerates or brakes, the speed set corresponds to the speed at which the accelerator or brake pedal is released or the rocker switch is pressed during DSR regulation. This is only the case if you are not driving faster than 18 km/h.

DSR status display in the on-board computer

- **DSR is activated:**
 - DSR and the set speed appear in the status area of the on-board computer.
- **DSR is activated, but is not intervening:**
 - you are driving between 18 km/h and 45 km/h.
 - DSR and the speed 18 km/h appear in the status area of the on-board computer. DSR is in standby mode.
- **DSR is inactive:**
 - as soon as you exceed a speed of 45 km/h.

- DSR appears in the status area of the on-board computer. In addition, the DSR off message appears.
- DSR --- appears in the status area of the on-board computer.

Setting the speed while driving downhill

You can set the speed depending on the gear range to between 4 km/h and 18 km/h using the brake and accelerator pedals or the rocker switch on the steering wheel.



- ▶ Brake or accelerate the vehicle to the desired speed on the downhill gradient.
- ▶ Release the brake or accelerator pedal. The current speed is stored.

or

- ▶ Press the rocker switch ① up or down during a DSR regulation. The last saved speed is increased or reduced.
- ▶ Release the rocker switch ①. The current speed is stored.

or

- ▶ Press the rocker switch ① up or down until desired speed is reached.
- ▶ Release the rocker switch ①. The current speed is stored.

- ① It may be a moment before the vehicle starts to brake to the set speed. Take this delay into account when setting the speed with the rocker switch ①.

Deactivating DSR

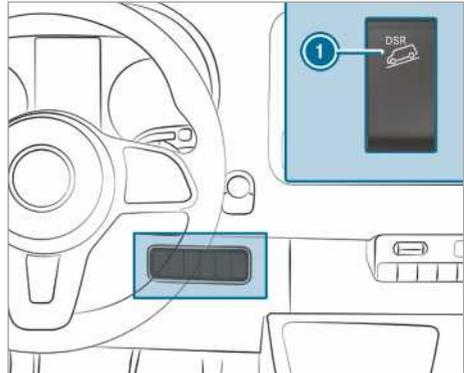

- ▶ Press the upper section of switch ①.
- or

- ▶ Accelerate and drive faster than 45 km/h.

DSR deactivates automatically in the following situations:

- as soon as you exceed a speed of 45 km/h.
- there is a malfunction in the ESP® or ABS system.

Electronic level control

Function of ENR (electronic level control)

- ⚠ **WARNING** Risk of entrapment from vehicle lowering

When lowering the vehicle, other people could become trapped if their limbs are between the vehicle body and the tyres or underneath the vehicle.

- ▶ Make sure no one is underneath the vehicle or in the immediate vicinity of the wheel arches when you lower the vehicle.

- ⚠ **WARNING** Risk of injury from jack tipping

If you park a vehicle with air suspension, the air suspension may remain activated for up to one hour, even when the ignition is switched off. If you then raise the vehicle with the jack, the air suspension will attempt to adjust the vehicle level.

The jack may tip.

- ▶ Press the Service button on the air suspension remote control before raising the vehicle.

This prevents automatic readjustment of the vehicle level and prevents it from being raised or lowered manually.

⚠ WARNING Risk of accident due to lowered or raised chassis

Driving with a lowered or raised chassis may greatly impair braking and handling characteristics. You may also exceed the permissible vehicle height when the chassis is raised.

- ▶ Set the driving level before pulling away.

⚠ WARNING Risk of accident from malfunction of electronic level control

If electronic level control is malfunctioning, the vehicle level may be asymmetrical, too high or too low.

The driving and steering characteristics of the vehicle may be noticeably different.

- ▶ Adapt your driving style accordingly and drive carefully.
- ▶ Stop, paying attention to road and traffic conditions.
- ▶ Consult a qualified specialist workshop.

ℹ NOTE Risk of damage to the chassis from lowered vehicle level

If electronic level control is malfunctioning or readjusts while you are driving, the vehicle level may be lowered.

- ▶ Pay attention to the road conditions and ensure there is sufficient ground clearance.
- ▶ Drive carefully.

The level of the vehicle depends on vehicle load and the load distribution. Electronic level control adjusts the level of the rear axle automatically on vehicles with an air-sprung rear axle. The vehicle level is thereby always maintained at the driving level, regardless of vehicle load. Driving dynamics remain unaffected. The height difference between the sides of the vehicle may be up to 1 cm.

Electronic level control is not engine-dependent and is only operational when the ignition is

switched on. The electronic level control compressor works audibly.

- ⓘ If the compressor works constantly or starts up several times per minute, electronic level control is malfunctioning.

Depending on the vehicle equipment, electronic level control switches between manual and automatic mode depending on either the vehicle speed or the position of the parking brake.

If electronic level control switches depending on vehicle speed, manual operation is automatically activated when the vehicle is stationary. You may raise or lower the vehicle level. If you subsequently drive faster than 10 km/h, manual mode is automatically deactivated and automatic mode sets the vehicle level.

If electronic level control switches depending on the parking brake position, manual mode is automatically activated when the parking brake is applied. You may raise or lower the vehicle level to load and unload. If you release the parking brake, manual mode is automatically deactivated and automatic mode sets the driving level.

When working on the vehicle or changing a wheel, you can deactivate electronic level control (→ page 137).

If electronic level control is malfunctioning or the vehicle level is too high or too low, an audible signal sounds.

The driving and steering characteristics of the vehicle will be noticeably different. Electronic level control adjusts the vehicle level to the normal level as soon as possible. Continue driving carefully until the audible signal stops. Only then is the vehicle at normal level.

Automatic mode and electronic level control automatically switch on again to restore the vehicle level, depending on the option selected:

- when the parking brake is released
- from speeds of approximately 10 km/h

If the electronic level control compressor threatens to overheat, e.g. due to repeated raising or lowering within a short period, electronic level control is deactivated. You can raise or lower the vehicle level again after approximately one minute.

Raising and lowering the vehicle level

Using the remote control

The remote control is located in a holder on the B-pillar on the driver's side. Remove the remote control from the holder before use.

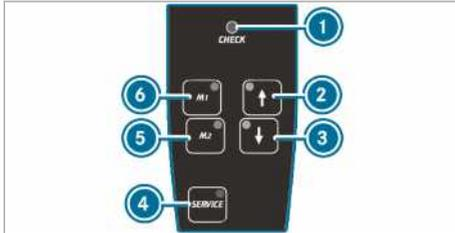

Electronic level control performs a self-check regularly when it is activated and while in use. Indicator lamp ① on the remote control lights up for approximately one second when you switch on either the ignition or electronic level control with button ④.

There is a malfunction if indicator lamp ① behaves in the following ways:

- the indicator lamp does not light up when you switch on the ignition or electronic level control
or
- the indicator lamp does not go out after one second
or
- the indicator lamp then lights up again or flashes

In addition, a warning tone is emitted from the remote control for approximately 30 seconds. The fault that has been detected can be shown using the indicator lamps (signalling of fault codes).

- ▶ Park the vehicle, leaving the ignition switched on.
- ▶ **To raise or lower the vehicle level:** press and hold button ② or ③ until the vehicle level reaches the required height. The indicator lamp on button ② or ③ flashes as long as the vehicle level is being changed. When the vehicle level has been set, the indicator lamp on button ② or ③ lights up.

- ▶ **To lower automatically:** briefly press button ③.

Electronic level control automatically lowers the vehicle down to the lowest position.

The indicator lamp on button ③ flashes as long as the vehicle level is being changed. When the vehicle level has been set, the indicator lamp on button ③ lights up.

- ▶ To stop the movement, briefly press button ②.

- ▶ **To raise or lower to driving level:** briefly press button ② or ③.

Electronic level control automatically raises or lowers the vehicle to driving level.

The indicator lamp on button ② or ③ flashes as long as the vehicle level is being changed. When the vehicle level has been set, the indicator lamp on button ② or ③ lights up.

- ▶ To stop the movement, briefly press the other button.

- ▶ **To save the set vehicle level:** set the required vehicle level.

- ▶ Press and hold button ⑤ or ⑥ until you hear a tone.

The vehicle level set has been saved on corresponding button ⑤ or ⑥.

- ▶ **To call up the saved vehicle level:** briefly press button ⑤ or ⑥.

Electronic level control automatically raises or lowers the vehicle to the saved driving level.

The indicator lamp on button ⑤ or ⑥ flashes as long as the vehicle level is being changed. When the vehicle level has been set, the indicator lamp on button ⑤ or ⑥ lights up.

- ▶ To stop the movement, briefly press button ② or ③.

- ▶ **To switch on automatically:** drive at over 10 km/h or release the parking brake.

Electronic level control controls the vehicle level automatically.

- ▶ To stop the movement, briefly press button ② or ③.

Switching electronic level control off/on

- ▶ **To switch electronic level control off:** press button ④.

The indicator lamp on button ④ lights up.

- ▶ **To switch electronic level control on again:** press button ④ again.
The indicator lamp on button ④ goes out.

Using the button in the control panel

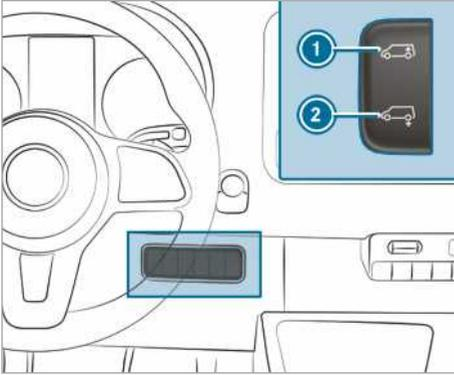

- ▶ Park the vehicle, leaving the ignition switched on.
- ▶ **To lower automatically:** briefly press the lower section of switch ②.
Electronic level control automatically lowers the vehicle.
- ▶ To stop the movement, briefly press the upper section of switch ①.
- ▶ **To raise to driving level:** briefly press the upper section of switch ①.
Electronic level control automatically raises the vehicle to the driving level.
- ▶ To stop the movement, briefly press the lower section of switch ②.
- ▶ **To switch on automatically:** drive at over 10 km/h or release the parking brake.
Electronic level control controls the vehicle level automatically.

Using electronic level control for charging with air in an emergency

Only for vehicles with valves for electronic level control emergency charging. If electronic level

control is malfunctioning and the vehicle is leaning, you can raise or lower the vehicle by connecting an external compressed-air source to one of the emergency valves (tyre valves). If electronic level control is deactivated, you can drive on carefully to the nearest qualified specialist workshop and have the malfunction remedied.

NOTE Damage due to pressure being too high

If the pressure in the air suspension bellows is too high, the compressed-air lines or the air suspension bellows may be damaged.

- ▶ Ensure you observe the maximum permissible operating pressure of 600 kPa (6 bar/87 psi).

- ▶ Apply the parking brake.
- ▶ **Vehicles with automatic transmission:** shift the transmission to position **P**.
- ▶ Switch off electronic level control (→ page 137).
- ▶ Switch off the engine and open the bonnet (→ page 278).
- ▶ Unscrew the valve cap of the corresponding valve.
- ▶ Connect the external compressed-air source.
- ▶ Raise or lower the vehicle level by charging or releasing compressed air until the driving level has been reached and the vehicle is in a horizontal position. While doing so, ensure you observe the maximum permissible operating pressure of 600 kPa (6 bar/87 psi).
- ▶ Disconnect the external compressed-air source.
- ▶ Tighten the valve caps on the valves.
- ▶ Close the bonnet (→ page 278).
- ▶ Drive on carefully to the nearest qualified specialist workshop.

Problems with the electronic level control

Problem	Possible causes/consequences and ▶ Solutions
You cannot raise or lower the vehicle level when stationary.	The compressor is in danger of overheating. After repeatedly raising and lowering the vehicle, electronic level control (play protection) is deactivated.

Problem	Possible causes/consequences and ► Solutions
	<ul style="list-style-type: none"> ► Try to set the vehicle level manually again after approximately one minute. <p>Electric level control has been deactivated due to undervoltage. The battery may not be charging.</p> <p>Handling and ride comfort may suffer.</p> <ul style="list-style-type: none"> ► Start the engine. ► Consult a qualified specialist workshop as soon as possible.

Refuelling

Refuelling the vehicle

⚠ **WARNING** Risk of fire or explosion from fuel

Fuels are highly flammable.

- Fire, naked flames, smoking and creation of sparks must be avoided.
- Switch off the ignition and, if available, the stationary heater, before and while refuelling the vehicle.

⚠ **WARNING** Risk of injury from fuels

Fuels are poisonous and hazardous to your health.

- Do not swallow fuel or let it come into contact with skin, eyes or clothing.
- Do not inhale fuel vapour.
- Keep children away from fuel.
- Keep doors and windows closed during the refuelling process.

If you or other people come into contact with fuel, observe the following:

- Immediately rinse fuel off your skin with soap and water.
- If fuel comes into contact with your eyes, immediately rinse them thoroughly with clean water. Seek medical attention immediately.
- If you swallow fuel, seek medical attention immediately. Do not induce vomiting.
- Change immediately out of clothing that has come into contact with fuel.

⚠ **WARNING** Risk of fire or explosion from electrostatic charge

Electrostatic charge can create sparks and thereby ignite fuel vapours.

- Before opening the fuel filler cap or taking hold of the pump nozzle, touch the metallic body of the vehicle. This discharges any electrostatic charge that may have built up.
- Do not get into the vehicle again during the refuelling process. Otherwise, electrostatic charge could build up again.

⚠ **WARNING** Risk of fire from fuel mixture

Vehicles with a diesel engine:

If you mix diesel fuel with petrol, the flash point of the fuel mixture is lower than that of pure diesel fuel.

While the engine is running, component parts in the exhaust system may overheat without warning.

- Never refuel using petrol.
- Never mix petrol with diesel fuel.

! **NOTE** Do not use petrol to refuel vehicles with a diesel engine.

If you accidentally refuel with the wrong fuel:

- Do not switch the ignition on. Otherwise, fuel can enter the fuel system.
- Even small amounts of the wrong fuel could result in damage to the fuel system and the engine. The repair costs are high.
- Consult a qualified specialist workshop.
 - Have the fuel tank and fuel lines drained completely.

! **NOTE** Damage to the fuel system caused by overfilled fuel tanks.

▶ Only fill the fuel tank until the pump nozzle switches off.

! **NOTE** Fuel may spray out when you remove the fuel pump nozzle.

▶ Only fill the fuel tank until the pump nozzle switches off.

! **Note** Damage to painted surfaces due to fuel

▶ Do not spill any fuel on painted surfaces.

🔥 ENVIRONMENTAL NOTE Environmental damage due to improper handling of fuel

If fuels are handled improperly, they pose a danger to persons and the environment.

▶ Do not allow fuels to run into the sewage system, the surface waters, the ground water or into the ground.

Requirements:

- the vehicle is unlocked.
 - the auxiliary heating is deactivated.
 - the ignition is switched off
 - the front left-hand door is open.
- i** Do not get back into the vehicle during the refuelling process. Otherwise, electrostatic charge could build up again.

Observe the notes on operating fluids (→ page 349).

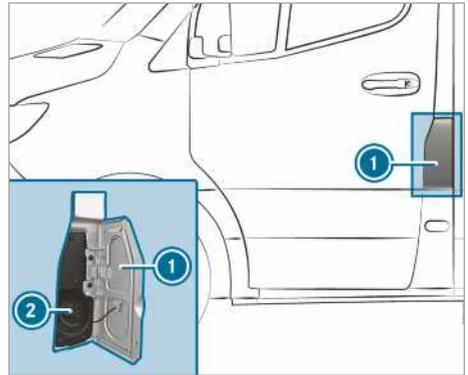

- 1** Fuel filler flap
- 2** Fuel filler cap

i The fuel filler flap is beside the front left-hand door when viewed in the direction of travel. The position of the fuel filler cap is also shown in the  instrument display. The arrow on the filling pump specifies the side of the vehicle.

- ▶ Open fuel filler flap **1**.
 - ▶ Turn fuel filler cap **2** anti-clockwise and remove it.
 - ▶ Close all vehicle doors to prevent fuel vapours from entering the vehicle interior.
 - ▶ Completely slide the filler neck of the pump nozzle into the tank, hook in place and refuel.
 - ▶ Fill the fuel tank only until the pump nozzle switches off.
 - ▶ Replace fuel filler cap **2** and turn it clockwise. You will hear a click when the fuel filler cap is closed fully.
 - ▶ Open the front left-hand door.
 - ▶ Close fuel filler flap **1**.
- i** **Vehicles with a diesel engine and incorrect fuelling protector against refuelling with petrol:** the filler neck is designed for refuelling at diesel filling pumps for passenger vehicles.
- i** **Vehicles with a diesel engine without incorrect fuelling protector:** you can also refuel at a diesel filling pump for lorries.
- i** If the fuel tank has been run completely dry, top up with at least 5 l of fuel.

Problems with the fuel and fuel tank

Problem	Possible causes/consequences and ► Solutions
Fuel is leaking from the vehicle.	<p>The fuel line or the fuel tank is faulty.</p> <ul style="list-style-type: none"> ► Apply the parking brake. ► Switch off the engine. ► Remove the key from the ignition lock. <p>Or, on vehicles with KEYLESS-GO:</p> <ul style="list-style-type: none"> ► Open the driver's door. <p>The on-board electronics are in position 0. This corresponds to the "key removed".</p> <ul style="list-style-type: none"> ► Do not restart the engine under any circumstances. ► Consult a qualified specialist workshop.
The engine does not start.	<p>The fuel tank has been run completely dry.</p> <ul style="list-style-type: none"> ► Refuel the vehicle with at least 5 l of fuel. ► Switch the ignition on for approximately ten seconds. ► Start the engine continuously for a maximum of ten seconds until it runs smoothly. <p>If the engine does not start:</p> <ul style="list-style-type: none"> ► Switch the ignition on for approximately ten seconds. ► Start the engine continuously for a maximum of ten seconds until it runs smoothly. <p>If the engine does not start after three attempts:</p> <ul style="list-style-type: none"> ► Consult a qualified specialist workshop.

AdBlue®

Notes on AdBlue®

! **NOTE** When you open the AdBlue® tank, small amounts of ammonia vapour may escape.

- Only fill the AdBlue® tank in well-ventilated areas.
- Do not let AdBlue® come into contact with skin, eyes or clothes.
- Keep AdBlue® away from children.

! **NOTE** Do not ingest AdBlue®.

If AdBlue® is swallowed:

- Immediately rinse out your mouth thoroughly.
- Drink plenty of water.
- Seek medical attention immediately.

! **NOTE** Damage caused by additives in AdBlue® or by diluting AdBlue®

The AdBlue® exhaust gas aftertreatment system could be destroyed by the following:

- additives in AdBlue®
 - diluting AdBlue®
- Only use AdBlue® in accordance with ISO 22241.
 - Do not mix additives.
 - Do not dilute AdBlue®.

! **NOTE** Damage and malfunctions caused by impurities in AdBlue®

Impurities in AdBlue® result in the following:

- higher emission values
- damage to the catalytic converter

- engine damage
 - malfunctions in the AdBlue® exhaust gas aftertreatment system
- ▶ Avoid impurities in AdBlue®.

! **NOTE** AdBlue® residue crystallises after some time. Remove AdBlue® residue.

- ▶ Immediately rinse surfaces that come in contact with AdBlue® when filling with water.
- ▶ AdBlue® can also be removed with a damp cloth and cold water.
- ▶ If AdBlue® has already crystallised, clean using a sponge and cold water.

AdBlue® is a liquid urea solution used for exhaust gas aftertreatment of diesel engines. In order for the exhaust gas aftertreatment to function properly, only use AdBlue® in accordance with ISO 22241.

AdBlue® has the following properties:

- non-toxic
- colourless and odourless
- non-flammable

AdBlue® availability:

- you can have AdBlue® topped up by fast service at a qualified specialist workshop, e.g. a Mercedes-Benz Service Centre.
- AdBlue® is available at numerous filling stations via AdBlue® filling pumps.
- alternatively, AdBlue® is available at qualified specialist workshops, e.g. a Mercedes-Benz Service Centre, and at numerous filling stations as an AdBlue® refill canister or AdBlue® refill bottle.

- i** AdBlue® freezes at a temperature of approximately -11 °C. The vehicle is equipped with an AdBlue® preheating system at the factory. This means that winter operation is also ensured for temperatures below -11 °C. If you top up AdBlue® at temperatures below -11 °C, the AdBlue® level in the instrument cluster may not be displayed correctly. If the AdBlue® is frozen, drive for at least 20 minutes and then park the vehicle for a minimum of 30 seconds, so that the level is correctly displayed. In extreme winter condi-

tions, the time needed to detect the top-up amount may be considerably longer. Park the vehicle in a warm garage to speed up this process.

- i** Ensure the connection between the refill container and vehicle filler neck does not drip.

Calling up the AdBlue® range and AdBlue® level gauge

On-board computer:

➔ **Service**

- ▶ Select **AdBlue** and confirm. The AdBlue® fill level and the AdBlue® range appear.

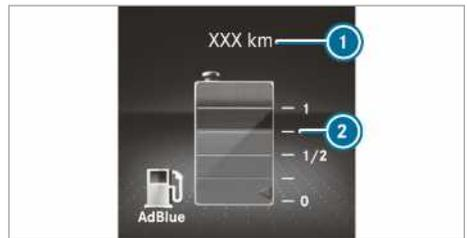

Instrument display with colour display

- 1** AdBlue® range
- 2** AdBlue® fill level

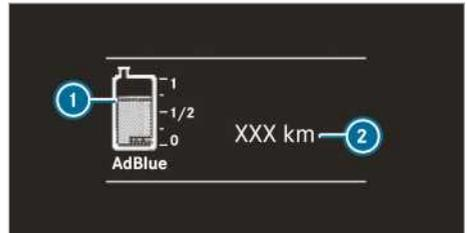

Instrument display with black and white display

- 1** AdBlue® fill level
- 2** AdBlue® range

Topping up AdBlue®

! **NOTE** Engine damage due to AdBlue® being in the fuel

- ▶ AdBlue® must not be used to fill the fuel tank.
- ▶ Only use AdBlue® to fill the AdBlue® tank.

- ▶ Do not overfill the AdBlue® tank.

! **NOTE** Contamination of the vehicle interior due to AdBlue® leakage

- ▶ After topping up, carefully close the AdBlue® refill container.
- ▶ Avoid carrying AdBlue® refill containers permanently in the vehicle.

Requirements:

- the ignition is switched off

Vehicles with passenger vehicle approval: the following messages that appear in succession in the multifunction display indicate that you need to refill the AdBlue® tank:

- **Refill AdBlue See Owner's Manual**

The AdBlue® tank has dropped to the reserve level.

- **Top up AdBlue Perf. reduced in XXX miles**

You will only be able to drive the vehicle the distance shown. Refill AdBlue® as quickly as possible.

- **Top up AdBlue Perf. reduced: 12 mph No start in XXX miles**

Vehicle speed is limited to approximately 20 km/h. You will only be able to drive the vehicle the distance shown. Subsequently, it will no longer be possible to start the engine.

- **Refill AdBlue Start not possible**

The vehicle can no longer be started.

Vehicles with commercial vehicle approval: the following messages that appear in succession in the multifunction display indicate that you need to refill the AdBlue® tank:

- **Refill AdBlue See Owner's Manual**

The AdBlue® tank has dropped to the reserve level.

- **Top up AdBlue Power reduced**
- **Top up AdBlue Performance reduced after eng. restart: 12 mph**

The vehicle cannot be driven at a speed exceeding 20 km/h after engine restart.

- **Top up AdBlue Performance reduced: 12 mph**

The vehicle cannot be driven at a speed exceeding 20 km/h.

You can also have the AdBlue® fill level and the AdBlue® range displayed (→ page 142).

Opening the AdBlue® filler cap on filler caps that are not lockable

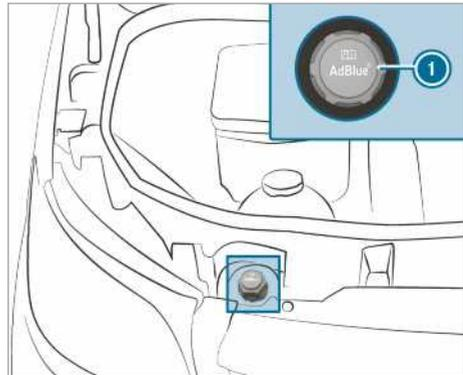

- ▶ Open the bonnet.
- ▶ Turn AdBlue® filler cap ① anti-clockwise and remove it.

Opening the AdBlue® filler cap on lockable filler caps

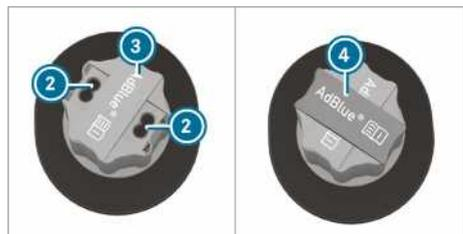
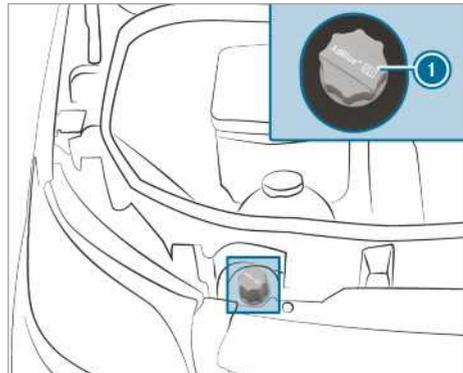

- ▶ Open the bonnet.

- ▶ Take tool ④ for unlocking AdBlue® filler cap ① from the vehicle tool kit.
- ▶ Pull cover ③ on AdBlue® filler cap ① up, turn 90° and release.
- ▶ Insert tool ④ in holes ② of AdBlue® filler cap ①.
- ▶ Turn AdBlue® filler cap ① anti-clockwise and remove it.

Preparing the AdBlue® refill canister



Variant 1



Variant 2

- ▶ Unscrew the cap on AdBlue® refill canister ②.
- ▶ Screw disposable hose ① onto the opening of AdBlue® refill canister ② until hand-tight.

Topping up AdBlue®

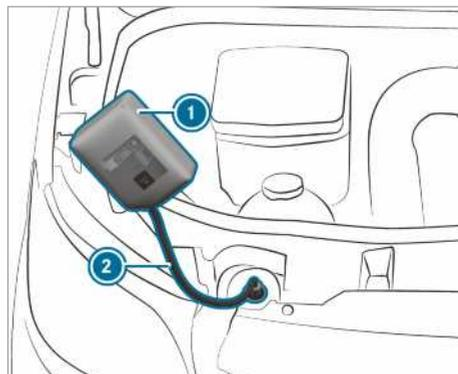

Variant 1

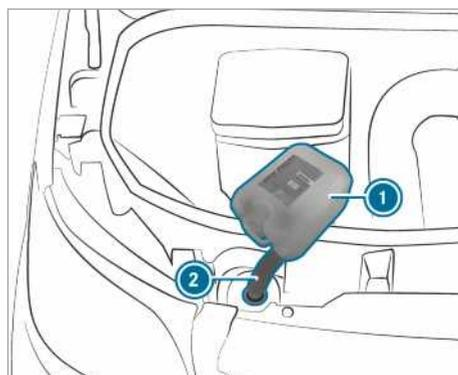

Variant 2

- ▶ Screw disposable hose ② onto the filler neck of the vehicle until hand-tight.
 - ▶ Lift up and tip AdBlue® refill canister ①. The filling process stops when the AdBlue® tank is completely full.
- AdBlue® refill canister ① can be removed when it has been only partially emptied.
- ▶ Unscrew disposable hose ② and close AdBlue® refill canister ① in reverse order.
 - ▶ Switch on the ignition for at least 60 seconds.
 - ▶ start the vehicle.
- ⓘ Avoid storing AdBlue® containers permanently in the vehicle.

AdBlue® refill bottle

Only screw the AdBlue® refill bottle hand-tight onto the filler opening in the engine compartment. It may otherwise be damaged.



AdBlue® refill bottles ① can be obtained at many filling stations or at a qualified specialist workshop. Refill bottles without a threaded cap offer no overflow protection. AdBlue® may leak out as a result of overfilling. Mercedes-Benz offers special refill bottles with a threaded cap. These are available at any Mercedes-Benz Service Centre.

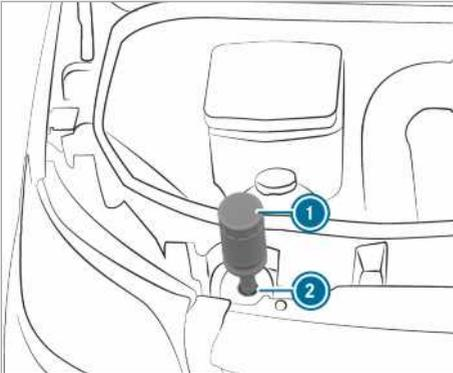

- ▶ Unscrew the protective cap from AdBlue® refill bottle ①.
- ▶ Place AdBlue® refill bottle ① as shown on filler opening ② and screw it on clockwise until hand-tight.
- ▶ Press AdBlue® refill bottle ① towards filler opening ②. The AdBlue® tank is filled. This could take up to one minute.

- ① When the AdBlue® refill bottle is no longer pressed down, filling stops. The bottle can be removed when it has been only partially emptied.

- ▶ Release AdBlue® refill bottle ①.
- ▶ Turn AdBlue® refill bottle ① anti-clockwise and remove it.
- ▶ Screw the protective cap onto AdBlue® refill bottle ① again.

Filling procedure with the pump nozzle of an AdBlue® filling pump

- ▶ Insert the pump nozzle into the filler neck and top up with AdBlue®. When doing so, do not overfill the AdBlue® tank.

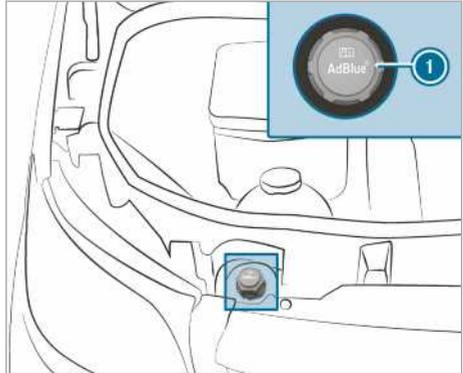
Closing the AdBlue® filler cap on filler caps that are not lockable

- ▶ After filling the AdBlue® tank, place AdBlue® filler cap ① on the filler neck and tighten it clockwise.
- ▶ Turn the AdBlue® filler cap until the lettering is legible and horizontal. The filler neck is only locked correctly when this is the case.
- ▶ Close the bonnet.

Closing the AdBlue® filler cap on lockable filler caps

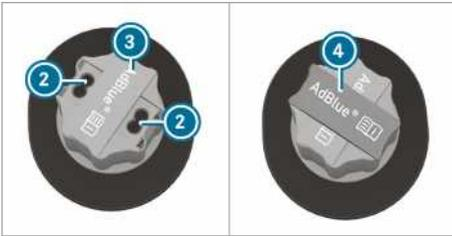
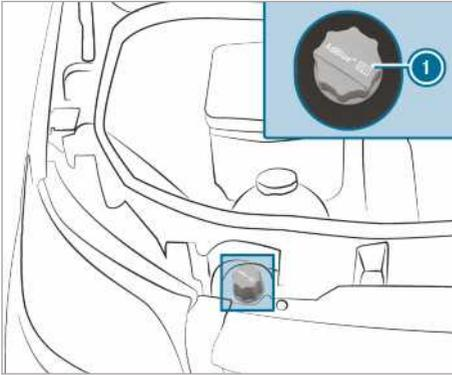

- ▶ After filling the AdBlue® tank, place AdBlue® filler cap ① on the filler neck and tighten it clockwise.
 - ▶ Remove tool ④ from AdBlue® filler cap ① and store it in the vehicle tool kit.
 - ▶ Pull cover ③ on AdBlue® filler cap ① up over holes ② of AdBlue® filler cap ①, turn and release.
 - ▶ Turn AdBlue® filler cap ①.
- If AdBlue® filler cap ① turns freely, the AdBlue® tank is closed.

Parking

Parking the vehicle

- ▲ **WARNING** Risk of fire caused by hot exhaust system parts

Flammable material such as leaves, grass or twigs may ignite if they come into contact with hot parts of the exhaust system or exhaust gas flow.

- ▶ Park the vehicle so that no flammable material can come into contact with hot vehicle components.
- ▶ In particular, do not park on dry grass-land or harvested grain fields.

- ▲ **WARNING** Risk of accident and injury due to children left unattended in the vehicle

If children are left unattended in the vehicle, they could:

- open doors, thereby endangering other persons or road users.
- get out of the vehicle and be hit by oncoming traffic.
- operate vehicle equipment and become trapped, for example.

In addition, children could also set the vehicle in motion, for example, by:

- releasing the parking brake.
- shifting the automatic transmission out of park position **P** or shifting manual transmission into neutral.
- starting the engine.

- ▶ When leaving the vehicle, always take the key with you and lock the vehicle.
- ▶ Never leave children and animals unattended in the vehicle.
- ▶ Keep the vehicle key out of reach of children.

- ! **NOTE** Damage to the vehicle or the drivetrain due to rolling away

- ▶ Always park your vehicle safely and according to legal requirements.
- ▶ Always properly secure the vehicle against rolling away.

- ▲ **WARNING** Risk of accident and injury if parking brake is not applied

If you park the vehicle with the transmission in park position **P** and the parking brake is not engaged, the vehicle may roll away.

Engaging park position **P** is not a fully adequate replacement for the parking brake.

There is a risk of accident and injury!

- ▶ Secure the vehicle against rolling away as described below.

Observe the following points to ensure that the vehicle is properly secured against rolling away unintentionally:

- ▶ always apply the parking brake.
 - ▶ **Vehicles with manual transmission:** engage first or reverse gear.
 - ▶ **Vehicles with automatic transmission:** engage transmission position **P**.
 - ▶ **On uphill or downhill inclines:** turn the front wheels towards the kerb.
 - ▶ **On uphill or downhill inclines:** secure the rear axle with a chock or an object without sharp edges (→ page 151).
- i** You can operate the side windows for five minutes after you have switched off the vehicle.

Manual parking brake

Applying/releasing the handbrake lever

- ⚠ WARNING** Risk of skidding or an accident by braking with the parking brake

If you have to brake your vehicle with the parking brake, the braking distance is considerably longer and the wheels may lock. There is an increased risk of skidding and/or accident.

- ▶ Only brake the vehicle with the parking brake if the service brake has failed.
- ▶ In this case, do not apply the parking brake with too much force.
- ▶ If the wheels lock, immediately release the parking brake as much as required for the wheels to turn again.

- ⚠ WARNING** Risk of fire and an accident if the parking brake is not released

If the parking brake is not fully released when driving, the following situations can occur:

- the parking brake can overheat and cause a fire
 - the parking brake can lose its holding function
- ▶ Completely release the parking brake before driving off.

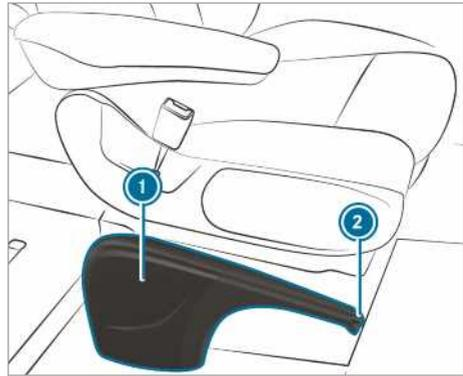

The brake lights do not light up when you brake the vehicle with the parking brake.

Generally, you may only apply the parking brake when the vehicle is stationary.

- ▶ **To apply the parking brake:** pull handbrake lever **1** up as far as the last possible detent. When the engine is running, the **(P)** indicator lamp lights up in the instrument display. If the vehicle is in motion, a warning tone sounds.

- i** In vehicles with a folding handbrake lever, you can then press handbrake lever **1** down as far as it will go.

- ▶ **To release the parking brake:** on vehicles with a folding handbrake lever, first pull handbrake lever **1** up as far as it will go.
- ▶ Pull handbrake lever **1** slightly and press release knob **2**.
- ▶ Guide handbrake lever **1** down to as far as it will go. The **(P)** indicator lamp in the instrument display goes out.

Folding the handbrake lever up or down (only in vehicles with a folding handbrake lever)

Requirements:

- The handbrake lever is applied.
- ▶ **To fold down the handbrake lever:** push the handbrake lever down as far as it will go.
 - ▶ **To raise the handbrake lever:** pull the handbrake lever up as far as it will go.

Performing emergency braking with the hand-brake lever

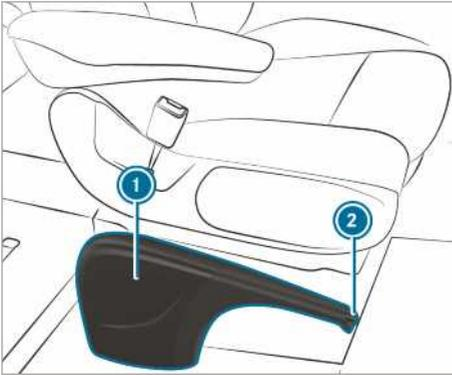

If, in exceptional cases, the service brake fails, you may use the parking brake to perform emergency braking.

► **Emergency braking:** press and hold release button ② and carefully pull brake lever ①.

Electric parking brake

Information on the electric parking brake

⚠ WARNING Risk of accident and injury due to children left unattended in the vehicle

If children are left unattended in the vehicle, they could:

- Open doors, thereby endangering other persons or road users.
- Get out and be struck by oncoming traffic.
- Operate vehicle equipment and become trapped, for example.

In addition, the children could also set the vehicle in motion, for example by:

- Releasing the parking brake.
- Changing the transmission position.
- Starting the vehicle.

- Never leave children unattended in the vehicle.
- When leaving the vehicle, always take the key with you and lock the vehicle.
- Keep the vehicle key out of reach of children.

For the automatic functions to work correctly, the driver must be seated in the correct seat position (→ page 64).

The function of the electric parking brake is dependent on the on-board electrical system voltage. If the on-board electrical system voltage is low or there is a malfunction in the system, it may not be possible to apply the electric parking brake and the yellow  indicator lamp lights up.

In this case, park the vehicle in the following way:

- Park the vehicle on level ground and secure it to prevent it from rolling away.
- **Vehicles with automatic transmission:** shift the transmission to position .
- **Vehicles with manual transmission:** engage first gear.

i The electric parking brake is only actually applied when the red  indicator lamp lights up continuously.

It may not be possible to release a parking brake if the on-board electrical system voltage is low or if there is a malfunction in the system. Inform a qualified specialist workshop. When the engine is switched off, the electric parking brake carries out a function test at regular intervals. Noises are normal in this process.

Automatically applying the electric parking brake

Vehicles with automatic transmission:

The electric parking brake is automatically applied when the transmission is in position .

In addition, at least one of the following conditions must be fulfilled:

- the engine is switched off
- the driver is not sitting in the driver's seat
- the belt buckle is undone

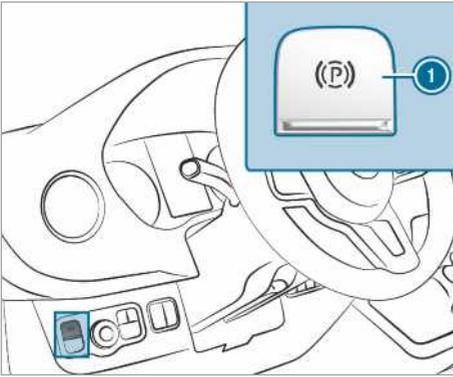

To prevent the electric parking brake from applying automatically, pull switch ①.

The electric parking brake is also automatically applied if Active Distance Assist DISTRONIC has brought the vehicle to a standstill.

In addition, at least one of the following conditions must be fulfilled:

- the engine is switched off
- the driver is not sitting in the driver's seat
- the belt buckle is undone
- there is a system malfunction
- the power supply is insufficient
- the vehicle is stationary for a long time

The red  indicator lamp in the instrument display lights up. The electric parking brake is only actually applied when the red  indicator lamp lights up continuously.

Vehicles with manual transmission:

The electric parking brake is automatically applied if at least one of the following conditions has been fulfilled:

- the engine is switched off
- the driver leaves the driver's seat
- the belt buckle is undone

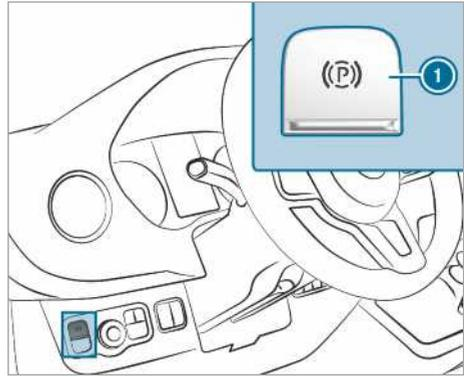

To prevent the electric parking brake from applying automatically, pull switch ①.

Releasing the electric parking brake automatically

Vehicles with automatic transmission:

The electric parking brake of your vehicle is released when all of the following conditions are fulfilled:

- The driver is sitting in the driver's seat.
- The driver is belted.
- The engine is running.
- The transmission is in position  or  and you depress the accelerator

or

you switch from transmission position  to position  or . You must also depress the accelerator if travelling on steep uphill gradients.

- If the transmission is in position , the rear doors must be closed.

Vehicles with manual transmission:

The electric parking brake of your vehicle is released when all of the following conditions are fulfilled:

- The driver is sitting in the driver's seat.
- The driver is belted.
- The engine is running.
- A gear is engaged.
- You release the clutch pedal and depress the accelerator pedal at the same time.
- When reverse gear is selected, the rear doors must be closed.

Applying/releasing the electric parking brake manually

▲ WARNING Risk of accident and injury due to children left unattended in the vehicle

If children are left unattended in the vehicle, they could:

- Open doors, thereby endangering other persons or road users.
- Get out and be struck by oncoming traffic.
- Operate vehicle equipment and become trapped, for example.

In addition, the children could also set the vehicle in motion, for example by:

- Releasing the parking brake.
- Changing the transmission position.
- Starting the vehicle.

- ▶ Never leave children unattended in the vehicle.
- ▶ When leaving the vehicle, always take the key with you and lock the vehicle.
- ▶ Keep the vehicle key out of reach of children.

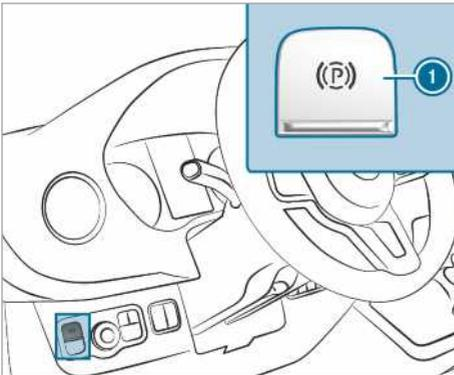

- ▶ **To apply:** press switch ①. When the electric parking brake is applied, the red  indicator lamp lights up in the instrument display. The electric parking brake is only actually applied when the red  indicator lamp lights up continuously. It is also possible to apply the electric parking brake when the ignition is switched off.

- ▶ **To release:** pull switch ①. The red  indicator lamp in the instrument display goes out. You may only release the electric parking brake if the ignition is switched on with the start/stop button.

Emergency braking

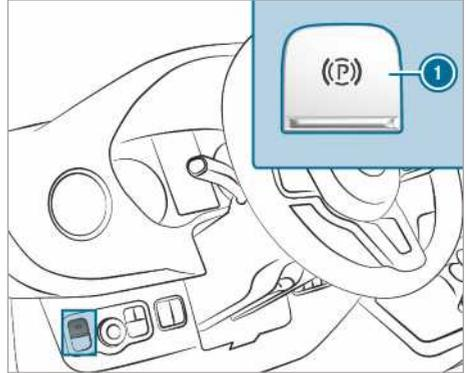

In the event of an emergency, you can brake the vehicle while it is in motion with the electric parking brake.

- ▶ While driving, press switch ① of the electric parking brake. The vehicle is braked as long as you keep switch ① of the electric parking brake depressed. The longer electric parking brake switch ① is depressed, the greater the braking force.

During the braking procedure, you will receive the following feedback from the vehicle:

- a warning tone sounds
- the "Release parking brake" display message appears
- the red  indicator lamp in the instrument display flashes

When the vehicle has been braked to a standstill, the electric parking brake is applied.

Parking up the vehicle

Parking up the vehicle for longer than four weeks

- ▶ **Method 1:** connect the batteries to a trickle charger.

▶ **Method 2:** disconnect the vehicle starter battery.

▶ **Method 3:** switch off the power supply using the battery main switch and disconnect the auxiliary battery on the vehicle.

▶ **Method 4:** interrupt the power supply by activating standby mode (→ page 151).

The charge level of the battery must be checked every three weeks if no measures are taken to maintain the battery charge.

▶ **Battery voltage below 12.2 V:** charge the battery to prevent deep discharge damage.

ⓘ Further information can be obtained at a qualified specialist workshop.

Standby mode

Activating/deactivating standby mode

Requirements:

- the engine is switched off.

On-board computer:

↳ Settings ▶ Vehicle

▶ Ruhezustand (Standby)

▶ **To activate/deactivate:** select **Yes** or **No**.

Using the chock

Use the chock to provide additional safety to prevent the vehicle from rolling away, e.g. when parking or changing a wheel.

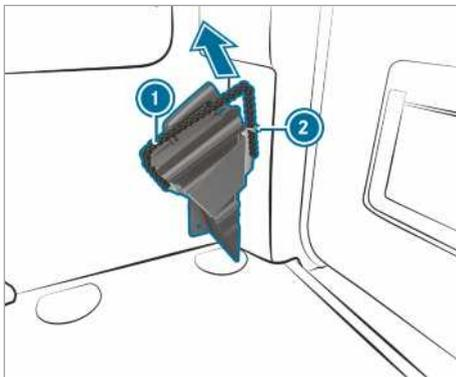

Chock in luggage/passenger compartment

▶ **To remove the chock:** pull the holding rope ⓘ slightly downwards and then remove it from bracket ⓘ.

▶ Remove the chock.

ⓘ When stowing it away, ensure that the chock has been secured in the bracket by the holding rope ⓘ.

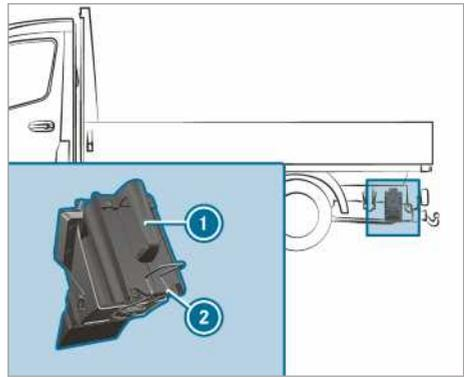

Chock at rear of chassis on left side of vehicle (example)

▶ **To remove the chock on platform vehicles:** pull the safety spring ⓘ downwards and remove the chock ⓘ.

ⓘ When stowing it away, ensure that the chock has been secured in the bracket by the safety spring.

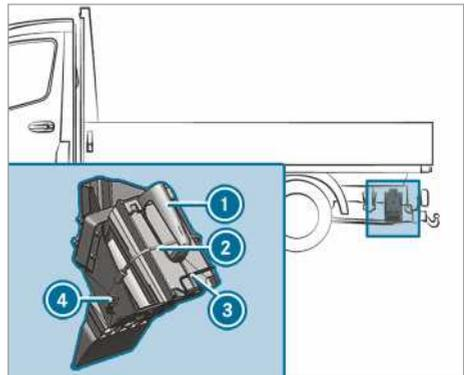

Chock at rear of chassis on left side of vehicle (example: front-wheel drive-vehicle)

▶ **To remove the chock on platform vehicles:** detach the rubber strap ⓘ from the hook ⓘ.

▶ Pull the safety spring ⓘ downwards and remove the chock ⓘ.

- ① When stowing it away, ensure that the chock has been secured in the bracket by the safety spring.

Driving and driving safety systems

Note on driving systems and your responsibility

Your vehicle is equipped with driving systems which assist you in driving, parking and manoeuvring the vehicle. The driving systems are aids and do not relieve you of your responsibility. Always pay attention to the traffic and intervene if necessary. Be aware of the limitations regarding the safe use of these systems.

Information about sensors

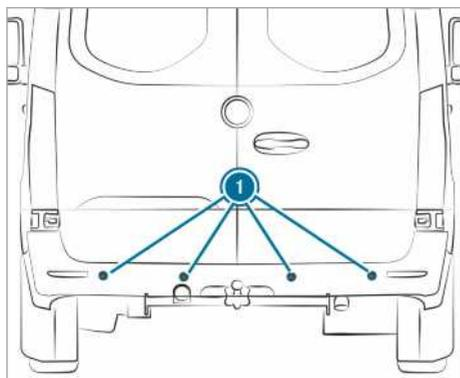

Certain driving and driving safety systems use sensors ① to monitor the area in front of, behind or next to the vehicle (depending on the vehicle's equipment).

Depending on the vehicle's equipment, the radar sensors are integrated behind the bumpers and/or behind the radiator grille. Keep these parts free of dirt, ice and slush (→ page 287). The sensors must not be covered, for example by bicycle racks, overhanging loads or stickers. After a collision, have the function of the radar sensors checked at a qualified specialist workshop as damage (both visible or non-visible) may have occurred to the bumper or radiator trim.

Function of driving systems and driving safety systems

In this section, you will find information about the following driving systems and driving safety systems:

- ABS (**A**nti-**l**ock **b**raking **s**ystem) (→ page 152)
- ASC (**A**cceleration **S**kid **C**ontrol) (→ page 153)
- BAS (**B**rake **A**ssist **S**ystem) (→ page 153)
- ESP® (**E**lectronic **S**tability **P**rogram) (→ page 153)
- EBD (**E**lectronic **B**rake**f**orce **D**istribution) (→ page 154)
- Active Brake Assist (→ page 155)
- Adaptive brake lights (→ page 157)
- Cruise control (→ page 157) and limiter (→ page 157)
- Active Distance Assist DISTRONIC (→ page 159)
- Hill start assist
- HOLD function (→ page 162)
- Parking Assist PARKTRONIC (→ page 162)
- Reversing camera (→ page 163)
- 360° Camera (→ page 165)
- ATTENTION ASSIST (→ page 168)
- Traffic Sign Assist (→ page 169)
- Blind Spot Assist (→ page 170)
- Active Lane Keeping Assist (→ page 173)

Functions of ABS (Anti-lock Braking System)

Observe the important safety guidelines for the driving safety system.

ABS controls the brake pressure in critical situations:

- the wheels are prevented from locking when braking, e.g. during maximum full-stop braking or when there is insufficient tyre traction
- the steerability of the vehicle in terms of physical possibilities is ensured when braking
- ABS is active from speeds of approx. 5 km/h. On a slippery road surface, ABS intervenes even if you only brake gently.

System limitations

If there is a malfunction and the yellow  ABS warning lamp lights up continuously in the instru-

ment display after starting the engine, ABS may be impaired or inoperative.

If ABS intervenes, you will feel a pulsing in the brake pedal. The pulsating brake pedal may be an indication of hazardous road conditions and functions as a reminder to take extra care while driving.

If ABS intervenes: keep the brake pedal firmly depressed until the braking situation has passed.

To carry out maximum full-stop braking: depress the brake pedal with full force.

Function of BAS (Brake Assist System)

⚠ WARNING Risk of an accident caused by a malfunction in BAS (Brake Assist System)

If BAS is malfunctioning, the braking distance in an emergency braking situation is increased.

▶ Depress the brake pedal with full force in emergency braking situations. ABS prevents the wheels from locking.

BAS supports you with additional braking force in an emergency braking situation.

If you depress the brake pedal quickly, BAS is activated:

- BAS automatically boosts the braking force of the brakes
- BAS can shorten the braking distance
- ABS prevents the wheels from locking

When you release the brake pedal, the brakes function as usual again. BAS is deactivated.

Functions of ASR (Acceleration Skid Control)

ASR can neither reduce the risk of an accident nor override the laws of physics if the driver does not pay attention when pulling away or accelerating. ASR is only an aid. Always adapt your driving style to suit the prevailing road and weather conditions.

If you activate or deactivate the all-wheel drive in a vehicle with this option, ASR will be deactivated for the duration of the activation/deactivation process.

Vehicles without steering wheel buttons: if ASR is malfunctioning, the  indicator lamp

lights up while the engine is running and the engine output may be reduced (→ page 27).

ASR improves traction, i.e. the transfer of power from the tyres to the road surface, for a sustained period and, thereby, also improves the driving stability of the vehicle. If the driving wheels start to spin, ASR brakes individual drive wheels and limits the engine torque. ASR thus significantly assists you when pulling away and accelerating, especially on wet or slippery roads.

If traction on the road surface is not sufficient, even ASR will not allow you to pull away without difficulty. The type of tyres and total weight of the vehicle as well as the gradient of the road also play a crucial role.

If ASR intervenes, the  warning lamp in the instrument display flashes.

Functions of ESP® (Electronic Stability Program)

⚠ WARNING Risk of skidding if ESP® is malfunctioning

If ESP® is malfunctioning, ESP® cannot carry out vehicle stabilisation. In addition, other driving safety systems are switched off.

- ▶ Drive on carefully.
- ▶ Have ESP® checked at a qualified specialist workshop.

⚠ WARNING Risk of skidding if ESP® is deactivated

If you deactivate ESP®, ESP® cannot carry out vehicle stabilisation.

- ▶ ESP® should only be deactivated in the following situations.

Do not operate the vehicle on a roller dynamometer (e.g. for a performance test). If you have to operate the vehicle on a roller dynamometer, consult a qualified specialist workshop beforehand.

If you activate or deactivate the all-wheel drive in a vehicle with this option, ESP® will be deactivated for the duration of the activation/deactivation process.

If ESP® is malfunctioning or deactivated, the  warning lamp lights up while the engine is running and the engine output may be reduced (→ page 27).

- ⓘ Only use wheels with the recommended tyre sizes. Only then will ESP® function properly.

Activating/deactivating ESP® (Electronic Stability Program)

Multimedia system:

→  → Settings → Quick access

→ ESP

- ⓘ ESP® can only be activated and deactivated via quick access when at least one other function is available in quick access. Otherwise, you can find ESP® in the Assistance menu.

▶ Select ESP.

A prompt appears.

▶ Select On or  Off.

If the  ESP® OFF warning lamp lights up constantly in the instrument cluster, ESP® is deactivated.

Observe the information on warning lamps and display messages which may appear in the instrument cluster.

Functions of ESP® Crosswind Assist

Crosswind Assist does not work if ESP® is deactivated or disabled due to a malfunction.

Crosswind Assist does not react under the following conditions:

- The vehicle is subjected to severe jolts and vibrations, e.g. as a result of uneven surfaces or potholes.
- The vehicle loses traction, e.g. on snow or ice or when aquaplaning.
- The driver is performing sudden and large steering movements.

Crosswind Assist is operational again as soon as the driving conditions return to normal.

Crosswind Assist detects strong crosswind gusts that can impair ability of your vehicle to drive straight ahead. Crosswind Assist intervenes depending on the direction and strength of the crosswind.

A stabilising brake application helps you to keep the vehicle on track.

Information is shown in the instrument cluster in the event of a clearly discernible intervention by Crosswind Assist.

Crosswind Assist is active above a vehicle speed of 80 km/h when the vehicle is driving straight ahead or cornering gently.

Function of ESP® trailer stabilisation

⚠ WARNING Risk of accident in poor road and weather conditions

In poor road and weather conditions, the trailer stabilisation cannot prevent lurching of the vehicle/trailer combination. Trailers with a high centre of gravity may tip over before ESP® detects this.

▶ Always adapt your driving style to suit the current road and weather conditions.

ESP® trailer stabilisation counteracts critical driving situations in good time and thereby provides considerable assistance when driving with a trailer. Trailer stabilisation is part of ESP®.

If the sensor system and evaluation logic detect trailer swinging movements, ESP® trailer stabilisation initially brakes individual vehicle wheels in a targeted manner. It thus counteracts swinging movements. If the swinging movements do not stop, the vehicle is braked until the vehicle/trailer combination is stabilised. If necessary, the vehicle's engine output is limited.

If your vehicle with trailer (vehicle/trailer combination) starts to swerve, you are able to stabilise the vehicle/trailer combination only by braking. ESP® trailer stabilisation helps you to stabilise the vehicle/trailer combination in this situation.

ESP® trailer stabilisation is active above speeds of 65 km/h.

If ESP® is deactivated because of a malfunction, trailer stabilisation will not function.

Function of EBD (Electronic Brakeforce Distribution)

EBD has the following characteristics:

- monitoring and controlling the braking force on the rear wheels
- improving driving stabilisation when braking, especially on bends

Function of Active Brake Assist

Active Brake Assist consists of the following functions:

- Distance warning function
- Autonomous braking function
- Situation-dependent braking assistance

Active Brake Assist can help you to minimise the risk of a collision with vehicles or pedestrians or to reduce the effects of such a collision.

If Active Brake Assist has detected a risk of collision, you will be warned visually and acoustically. If you do not react to the visual or acoustic warning, autonomous braking can be initiated in critical situations.

If there are pedestrians and cyclists crossing; in especially critical situations, Active Brake Assist can initiate autonomous braking directly. In this case, the visual and acoustic warning occurs simultaneously with the braking application.

If you apply the brake yourself in a critical situation, or apply the brakes during autonomous braking, situation-dependent braking assistance occurs. The brake pressure increases up to maximum full-stop braking if necessary. Situation-dependent braking assistance only intervenes when the brakes are applied firmly; otherwise, it remains within the autonomous braking process.

⚠ WARNING Risk of accident caused by limited detection performance of Active Brake Assist

Active Brake Assist cannot always clearly identify objects and complex traffic situations.

Due to the nature of the system, complex driving conditions may also cause Brake Assist to intervene or not intervene without

reason. In such cases, and in the event of Active Brake Assist malfunctioning, the brake system will continue to be available with full brake boost and BAS.

- ▶ Always pay careful attention to the traffic situation; do not rely on Active Brake Assist alone. Active Brake Assist is only an aid. The driver of the vehicle is responsible for keeping a sufficiently safe distance to the vehicle in front, for vehicle speed and for braking in good time.
- ▶ Be prepared to brake or swerve if necessary.

Also observe the system limitations of Active Brake Assist.

The individual subfunctions are available in the following speed ranges: Distance warning function

The distance warning function warns you in the following situations:

- At speeds greater than approximately 30 km/h, if over several seconds the distance maintained to the vehicle travelling in front is insufficient for the driven speed.

The  distance warning lamp then lights up in the instrument cluster.

- At speeds greater than approximately 7 km/h, if your vehicle is critically close to a vehicle or pedestrian.

An intermittent warning tone sounds and the  distance warning lamp lights up in the instrument cluster.

Brake immediately or take evasive action, provided it is safe to do so and the traffic situation allows this.

The distance warning function can aid you in the following situations with an intermittent warning tone and a warning lamp:

Vehicles travelling in front	Stationary vehicles	Crossing vehicles	Crossing pedestrians/cyclists	Stationary pedestrians
Up to approx. 250 km/h	Up to approx. 200 km/h	No reaction	Up to approx. 60 km/h	No reaction

Autonomous braking function

The autonomous braking function may intervene at speeds starting from approximately 7 km/h in the following situations:

Vehicles travelling in front	Stationary vehicles	Crossing vehicles	Crossing pedestrians/cyclists	Stationary pedestrians
Up to approx. 250 km/h	Up to approx. 200 km/h	No reaction	Up to approx. 60 km/h	No reaction

Situation-dependent braking assistance

Situation-dependent braking assistance may intervene at speeds starting from approximately 7 km/h in the following situations:

Vehicles travelling in front	Stationary vehicles	Crossing vehicles	Crossing pedestrians/cyclists	Stationary pedestrians
Up to approx. 250 km/h	Up to approx. 80 km/h	No reaction	Up to approx. 60 km/h	No reaction

Cancelling a brake application of Active Brake Assist

You can cancel a brake application of Active Brake Assist at any time by:

- Fully depressing the accelerator pedal or with kickdown.
- Fully releasing the brake pedal (only during situation-dependent braking assistance).

Active Brake Assist may cancel the brake application when one of the following conditions is fulfilled:

- You manoeuvre to avoid the obstacle.
- There is no longer a risk of collision.
- An obstacle is no longer detected in front of your vehicle.

System limitations

The system may be impaired or may not function in the following situations:

- The sensors are affected by snow, rain, fog or heavy spray.
- The sensors are dirty, misted up, damaged or covered.
- The sensors are affected by interference from other radar sources, e.g. strong radar reflections in multi-storey car parks.
- If a loss of tyre pressure or a defective tyre has been detected and displayed.

- Full system performance is not available for a few seconds after switching on the ignition or after driving off.

The system may not react correctly in the following situations:

- In complex traffic situations, objects may not always be clearly detected.
- Pedestrians or vehicles move quickly into the detection range of the sensors.
- Pedestrians are obscured by other objects.
- In bends with a narrow radius.

Setting Active Brake Assist

Requirements:

- The ignition is switched on

Multimedia system:

  **» Settings » Assistance**
» Active Brake Assist

The following settings are available:

- [Early](#)
- [Medium](#)
- [Late](#)

 Select a setting.

The [Medium](#) setting is selected automatically every time the engine is started.

Deactivating Active Brake Assist

- ❗ It is recommended that Active Brake Assist is always left activated.
- ▶ **Select Off.**
The distance warning function and autonomous braking function are deactivated.
- ❗ When Active Brake Assist is deactivated, the  symbol appears in the status area of the multifunction display.

Function of Adaptive Brake Lights

Adaptive Brake Lights warn following traffic in an emergency braking situation with the following signals:

- flashing the brake lamps
- activating the hazard warning lights

If the vehicle is braked sharply from speeds above 50 km/h, the brake lamps flash rapidly. This provides traffic travelling behind you with an even more noticeable warning.

If the vehicle is travelling at speeds of more than 70 km/h at the beginning of the brake application, the hazard warning lights switch on once the vehicle is stationary. When you pull away again, the hazard warning lights will switch off automatically at approximately 10 km/h. You can also switch off the hazard warning lights using the hazard warning button.

Cruise control and limiter

Function of cruise control

Cruise control accelerates and brakes the vehicle automatically in order to maintain a previously stored speed.

If you accelerate to overtake, for example, the stored speed is not deleted. If you remove your foot from the accelerator pedal after overtaking, cruise control will resume speed regulation back to the stored speed.

Cruise control is operated using the corresponding steering wheel buttons. You can store any road speed above 20 km/h.

If you fail to adapt your driving style, cruise control can neither reduce the risk of an accident nor override the laws of physics. It cannot take into account road, weather or traffic conditions. Cruise control is only an aid. You are responsible for the distance to the vehicle in front, for vehicle

speed, braking in good time and for staying in your lane.

Displays in the multifunction display

The status of cruise control and the stored speed are shown in the multifunction display.



Display in the instrument display (colour display)

- ❶ Cruise control is selected
- ❷ Set speed grey: speed is stored, cruise control is deactivated
- ❸ Set speed green: speed is stored, cruise control is activated

System limitations

Cruise control may be unable to maintain the stored speed on uphill gradients. The stored speed is resumed when the gradient evens out.

On long and steep downhill gradients, you should change down to a lower gear in good time. Take particular note of this when driving a laden vehicle. By doing so, you will make use of the engine's braking effect. This relieves the load on the brake system and prevents the brakes from overheating and wearing too quickly.

Do not use cruise control in the following situations:

- In traffic situations where frequent speed changes are required, e.g. in heavy traffic or on winding roads.
- On slippery roads. Accelerating can cause the drive wheels to lose traction and the vehicle could then skid.
- If you are driving when visibility is poor.

Function of the limiter

Vehicle with a permissible gross mass of up to 3.5 t: the limiter limits the vehicle's speed. To reduce the speed swiftly to the set speed, the limiter applies the brakes automatically.

Vehicle with a permissible gross mass of over 3.5 t: the limiter limits the vehicle's speed.

You can limit the speed as follows:

- Variable: for speed limits, e.g. in built-up areas.
- Permanent: for long-term speed restrictions, e.g. when driving in winter tyre mode.

The variable limiter is operated using the corresponding steering-wheel buttons. You can store any road speed above 20 km/h. You can also perform settings while the vehicle is stationary if the vehicle has been started.

If you exceed the set speed with the variable limiter by over 3 km/h, the **LIM** symbol flashes in the instrument display. The **Limiter set speed exceeded** message appears. The flashing stops as soon as the speed drops below the set speed again.

If you fail to adapt your driving style, the limiter can neither reduce the risk of an accident nor override the laws of physics. It cannot take into account road, weather or traffic conditions. The limiter is only an aid. You are responsible for the distance to the vehicle in front, for vehicle speed, braking in good time and for staying in your lane.

Displays in the multifunction display

The status of the limiter and the stored speed are shown in the multifunction display.

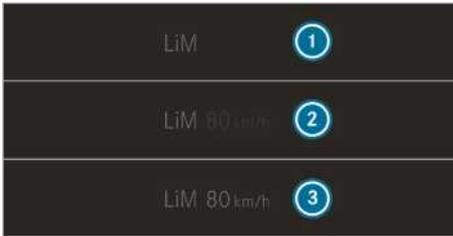

Instrument display (colour display)

- ① Limiter is selected
- ② Set speed grey: speed is stored, limiter is deactivated
- ③ Set speed green: speed is stored, limiter is activated

Kickdown

If you depress the accelerator pedal beyond the pressure point (kickdown), the limiter switches to passive mode.

If you exceed the set speed with the variable limiter by over 3 km/h, the **LIM** symbol flashes in the instrument display. The **Limiter set speed exceeded** message appears.

After completion of kickdown, the variable limiter is activated again in the following situations:

- If the driven speed drops below the stored speed.
- If the stored speed is called up.
- If you store a new speed.

Operating cruise control or the variable limiter

⚠ WARNING Risk of accident due to stored speed

If you call up the stored speed and this is lower than your current speed, the vehicle decelerates.

- ▶ Take into account the traffic situation before calling up the stored speed.

Requirements:

Cruise control

- Cruise control is selected.
- ESP® is activated, but may not intervene.
- The driving speed is at least 20 km/h.

Variable limiter

- The vehicle has been started.
- The variable limiter is selected.

Switching between cruise control and the variable speed limiter

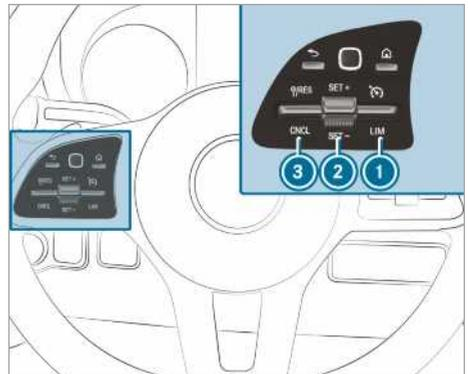

- ▶ **To select cruise control:** push rocker switch ① up.
- ▶ **To select the variable limiter:** push rocker switch ① down.

- ① Vehicles with Active Distance Assist DISTRONIC: the variable limiter is selected by a different button (→ page 161).

Activating cruise control or the variable limiter

- ▶ Push rocker switch ② up (SET+) or down (SET-).
- ▶ Remove your foot from the accelerator pedal. The current speed is stored and the vehicle maintains this speed (cruise control) or does not exceed it (variable speed limiter).

Increasing/decreasing speed

- ▶ Push rocker switch ② up/down. The stored speed is increased or reduced by 1 km/h.
- or
- ▶ Press rocker switch ② up or down and hold. The stored speed is increased or reduced in 1 km/h increments.
- or
- ▶ Push rocker switch ② up or down beyond the pressure point. The stored speed is increased or reduced by 10 km/h.
- or
- ▶ Press rocker switch ② up or down beyond the pressure point and hold. The stored speed is increased or reduced in 10 km/h increments.
- or
- ▶ Accelerate the vehicle to the desired speed.
- ▶ Push rocker switch ② up (SET+) or down (SET-).
- ▶ Remove your foot from the accelerator pedal. The current speed is stored and the vehicle maintains this speed (cruise control) or does not exceed it (variable speed limiter).
- ① **Vehicles with manual transmission:** if the engine speed is very low, cruise control or the limiter is deactivated. When the engine speed approaches maximum engine speed, the transmission is in neutral or the clutch pedal is depressed for longer than six seconds, cruise control is deactivated.

Adopting the detected speed

If cruise control/the variable limiter is activated and Traffic Sign Assist has detected a speed restriction sign, and this maximum permissible speed is displayed in the instrument display:

- ▶ Push rocker switch ③ up. The maximum permissible speed shown by the traffic sign is stored and the vehicle maintains or does not exceed this speed.

Deactivating cruise control or the variable limiter

- ▶ Press rocker switch ③ (CNCL) down.

When cruise control or the variable limiter is deactivated:

- rocker switch ② (SET+) or (SET-) stores the current speed and the vehicle maintains this speed.
- rocker switch ③ (RES) calls up the last speed stored and the vehicle maintains this speed.

- ① If you brake, deactivate ESP® or if ESP® intervenes, cruise control is deactivated. The variable limiter is not deactivated. When you switch off the vehicle, the last speed stored is cleared.

Information on the permanent limiter

If the vehicle should never exceed a specific speed (e.g. for driving in winter tyre mode), you can set this speed with the permanent limiter.

You do this by limiting the speed to a value between 120 km/h and 180 km/h in the multimedia system (→ page 159).

Shortly before the set speed is reached, it appears in the multifunction display. When you confirm the message with , display messages no longer appear until you switch off the vehicle. The speed will only be displayed again once the vehicle has been restarted.

The permanent limiter does not switch to passive mode even during kickdown and the driven speed remains below the set speed.

Setting the speed limitation for winter tyres

Multimedia system:

-  ▶ Settings ▶ Fahrzeug (Vehicle) ▶ Winter tyres limit
- ▶ Select a speed or deactivate the function.

Active Distance Assist DISTRONIC

Function of Active Distance Assist DISTRONIC

Active Distance Assist DISTRONIC maintains the set speed on free-flowing roads. If vehicles ahead are detected, the set distance is maintained, if necessary until the vehicle comes to a halt. The vehicle accelerates or brakes depending on the

distance to the vehicle in front and the set speed. Speed and distance are set and stored on the steering wheel. The speed can be set in the range between 20 km/h and 160 km/h or between 20 km/h and the vehicle's maximum speed.

Other features of Active Distance Assist DISTRONIC:

- Depending on the preselected distance, DISTRONIC intervenes either dynamically (short distance) or to save fuel (long distance).
- Depending on the vehicle mass detected, the dynamics of the DISTRONIC intervention are reduced.
- Rapid acceleration to the stored speed is initiated if the turn signal indicator is switched on to change to the overtaking lane.

Active Distance Assist DISTRONIC is only an aid. The driver is responsible for the distance to the vehicle in front, for vehicle speed and for braking in good time.

System limitations

The system may be impaired or may not function in the following instances:

- The radar sensors are affected by snow, rain, fog, heavy spray, glare, direct sunlight or greatly varying light conditions.
- The radar sensors may malfunction in multi-storey car parks or on roads with steep uphill or downhill gradients.
- If the radar sensors are dirty or covered.
- On icy or slippery roads, braking or accelerating can cause the drive wheels to lose traction and the vehicle could then skid.
- Stationary objects are not detected if these were not previously detected as moving.
- On bends, target vehicles may be lost or not recognised correctly. As a result, a target vehicle is not used to regulate the speed which may lead to unwanted acceleration.

Do not use Active Distance Assist DISTRONIC in these situations.

⚠ WARNING Risk of accident from acceleration or braking by Active Distance Assist DISTRONIC

Active Distance Assist DISTRONIC may accelerate or brake in the following cases, for example:

- If the vehicle pulls away using Active Distance Assist DISTRONIC.
 - If the stored speed is called up and is considerably faster or slower than the currently driven speed.
 - If Active Distance Assist DISTRONIC no longer detects a vehicle in front or does not react to relevant objects.
- ▶ Always carefully observe the traffic conditions and be ready to brake at all times.
- ▶ Take into account the traffic situation before calling up the stored speed.

⚠ WARNING Risk of accident due to insufficient deceleration by Active Distance Assist DISTRONIC

Active Distance Assist DISTRONIC brakes your vehicle with up to 50 % of the maximum possible deceleration. If this deceleration is not sufficient, Active Distance Assist DISTRONIC alerts you with a visual and acoustic warning.

- ▶ In these cases, adjust your speed and keep a sufficient distance.
- ▶ Brake the vehicle yourself and/or take evasive action.

⚠ WARNING Risk of accident if detection function of Active Distance Assist DISTRONIC is impaired

Active Distance Assist DISTRONIC does not react or has a limited reaction:

- when driving on a different lane or when changing lanes
- to pedestrians, animals, bicycles or stationary vehicles, or unexpected obstacles
- to complex traffic conditions
- to oncoming vehicles and crossing traffic

As a result, Active Distance Assist DISTRONIC may neither give warnings nor intervene in such situations.

- ▶ Always observe the traffic conditions carefully and react accordingly.

Active Distance Assist DISTRONIC may not detect narrow vehicles driving in front, e.g. motorcycles and vehicles driving on a different line.

Operating Active Distance Assist DISTRONIC

Requirements:

- The vehicle has been started.
- The parking brake has been released.
- ESP® is activated and is not intervening.
- The transmission is in position **D**.
- The driver's and the co-driver door are closed.
- The seat occupancy recognition on the driver's seat has detected that the driver has fastened the seat belt.
- The check of the radar sensor system has been successfully completed.

Switching between the limiter and Active Distance Assist DISTRONIC

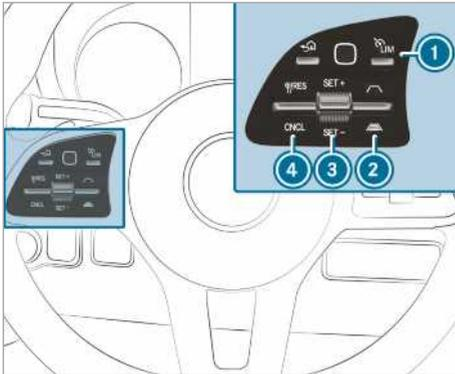

- ▶ Press button **1**.

Activating Active Distance Assist DISTRONIC or the variable limiter

- ▶ **To activate without a stored speed:** press rocker switch **3** up (SET+) or down (SET-). The current speed is stored and maintained by the vehicle (Active Distance Assist DISTRONIC) or limited (variable limiter).

or

- ▶ **To activate with a stored speed:** press rocker switch **4** up (RES).

- i** If rocker switch **4** is pressed up twice, Active Distance Assist DISTRONIC or the vari-

able limiter is activated with the speed restriction displayed in the instrument cluster.

Accepting the displayed speed limit when Distance Assist DISTRONIC or limiter is activated

- ▶ Press rocker switch **4** up (RES). The speed limit displayed in the instrument cluster is adopted as the stored speed. The vehicle adapts its speed to that of the vehicle in front, but only up to the stored speed.

Pulling away again with Active Distance Assist DISTRONIC

- ▶ Remove your foot from the brake pedal.
 - ▶ Press rocker switch **4** up (RES).
- or
- ▶ Depress the accelerator pedal briefly with force. The functions of Active Distance Assist DISTRONIC continue to be carried out.

Deactivating Active Distance Assist DISTRONIC

- ⚠ WARNING** Risk of accident due to Active Distance Assist DISTRONIC still being activated when you leave the driver's seat

If you leave the driver's seat while the vehicle is being braked by Active Distance Assist DISTRONIC only, the vehicle can roll away.

- ▶ Always deactivate Active Distance Assist DISTRONIC and secure the vehicle to prevent it from rolling away before you leave the driver's seat.

- ▶ Press rocker switch **4** down (CNCL).
- ▶ Depress the brake pedal.

Increasing or reducing the speed

- ▶ Push rocker switch **3** up (SET+) or down (SET-). The stored speed is increased or reduced by 1 km/h.

or

- ▶ Press and hold rocker switch **3** up (SET+)/down (SET-). The stored speed is increased or reduced in 1 km/h increments.

or

- ▶ Push rocker switch ③ beyond the pressure point.
The stored speed is increased or reduced by 10 km/h.

or

- ▶ Push rocker switch ③ beyond the pressure point and hold.
The stored speed is increased or reduced in 10 km/h increments.

Increasing or reducing the specified distance from the vehicle in front

- ▶ **To increase the specified distance:** press

rocker switch ② down .

- ▶ **To reduce the specified distance:** press

rocker switch ② up .

Information on Hill Start Assist

Hill Start Assist holds the vehicle for a short time when pulling away on a hill under the following conditions:

- **Vehicles with manual transmission:** a gear is engaged.
- **Vehicles with automatic transmission:** the transmission is in position **D** or **R**.
- The parking brake has been released.

This gives you enough time to move your foot from the brake pedal to the accelerator pedal and depress it before the vehicle begins to roll.

▲ WARNING Risk of accident and injury due to the vehicle rolling away

After a short time, Hill Start Assist no longer holds the vehicle and it can roll away.

- ▶ Therefore, swiftly move your foot from the brake pedal to the accelerator pedal. Never attempt to leave the vehicle if it is being held by Hill Start Assist.

HOLD function

HOLD function

Requirements:

- The seat occupancy recognition on the driver's seat has detected that the driver has fastened the seat belt.

The HOLD function holds the vehicle at a standstill without requiring you to depress the brake pedal, e.g. when pulling away on steep slopes. When you depress the accelerator pedal to pull away, the braking effect is cancelled and the HOLD function is deactivated.

System limitations

- The incline must not be greater than 30%.

Parking Assist PARKTRONIC

Function of Parking Assist PARKTRONIC

Parking Assist PARKTRONIC is an electronic parking assistance system with ultrasound. It monitors the area around your vehicle using six sensors on the front bumper and six sensors on the rear bumper. Parking Assist PARKTRONIC indicates visually and audibly the distance between your vehicle and an object.

Parking Assist PARKTRONIC is only an aid. It is not a substitute for your attention to the surroundings. The responsibility for safe manoeuvring and parking remains with you. Make sure that there are no persons, animals or objects in the manoeuvring area while manoeuvring and parking in/ exiting parking spaces.

In the standard setting, an intermittent warning tone sounds from a distance of approximately 0.4 m to an obstacle. A continuous tone sounds from a distance of approximately 0.3 m. You can set the warning tone in the multimedia system so that it will sound earlier at a greater distance of approximately 1 m (→ page 163).

Parking Assist PARKTRONIC display in the multimedia system

If the Parking Assist PARKTRONIC display in the multimedia system is not active and an obstacle is detected in the path of the vehicle, a pop-up window for Parking Assist PARKTRONIC appears in the multimedia system at speeds up to approximately 10 km/h.

System limitations

Parking Assist PARKTRONIC does not necessarily take into account the following obstacles:

- Obstacles below the detection range, e.g. persons, animals or objects.
- Obstacles above the detection range, e.g. overhanging loads, overhangs or loading ramps of lorries.

The sensors must be free of dirt, ice and slush. Otherwise, they may not function correctly. Clean

the sensors regularly, taking care not to scratch or damage them.

Vehicles with trailer hitch: Parking Assist PARKTRONIC is deactivated for the rear zone when you establish an electrical connection between your vehicle and a trailer.

Deactivating/activating Parking Assist PARKTRONIC

! **NOTE** Risk of an accident from objects at close range

Parking Assist PARKTRONIC may not detect certain objects at close range.

- ▶ When parking or manoeuvring the vehicle, pay particular attention to any objects which are above or below the sensors, e.g. flowerpots or drawbars. The vehicle or other objects could otherwise be damaged.

Multimedia system:

→  ▶ Settings ▶ Quick access

- ▶ Select **PARKTRONIC On**.
The function is activated or deactivated depending on the previous setting.
- ⓘ Parking Assist PARKTRONIC is automatically activated when starting the vehicle.

Setting the warning tones of Parking Assist PARKTRONIC

Multimedia system:

→ Settings ▶ Assistance
▶ Camera & parking ▶ Set warning tone

Adjusting the volume of the warning tones

- ▶ Select **Warning tone volume**.
- ▶ Adjust the value.

Adjusting the pitch of the warning tones

- ▶ Select **Warning tone pitch**.
- ▶ Adjust the value.

Specifying the starting point for the warning tones

You can specify whether the Parking Assist PARKTRONIC warning tones should commence when the vehicle is further away from an obstacle.

- ▶ Select **Warn early all-round**.
- ▶ Activate or deactivate the function.

Activating or deactivating audio fadeout

You can specify whether the volume of a media source in the multimedia system is to be reduced when Parking Assist PARKTRONIC gives a warning tone.

- ▶ Select **Audio fadeout during warning tones**.
- ▶ Activate or deactivate the function.

Reversing camera

Function of the reversing camera

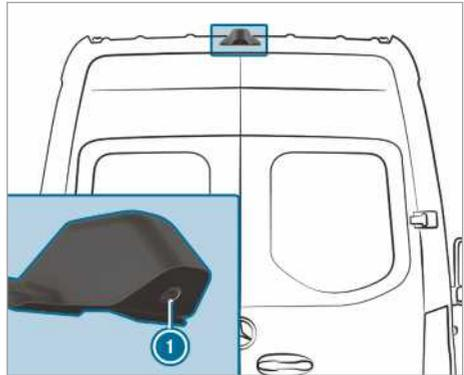

If you have activated the function in the multimedia system, the image from reversing camera ① appears in the multimedia system when reverse gear is selected. Dynamic guide lines show the path the vehicle will take with the steering wheel in its current position. This helps you to orient yourself and to avoid obstacles when reversing.

The image from reversing camera ① appears in the multimedia system when the following conditions are fulfilled:

- The ignition is switched on.
- Reverse gear has not been engaged.
- The rear doors are opened.

This means that the area behind the vehicle can be monitored.

When the rear doors are closed, the image from the reversing camera is switched off after approximately ten seconds.

The reversing camera is only an aid. It is not a substitute for your attention to the surroundings. The responsibility for safe manoeuvring and parking remains with you. Make sure that there are no persons, animals or objects etc., in the manoeuvring area while manoeuvring and parking.

The reversing camera may show a distorted view of obstacles, show them incorrectly or not at all. The reversing camera cannot display all objects which are very near to or under the rear bumper. It will not warn you of a collision, people or objects.

You can select from the following views:

- Normal view
- Wide-angle view
- Trailer view

The area behind the vehicle is displayed as a mirror image, as in the inside rearview mirror.

System limitations

The reversing camera will not function or will only partially function in the following situations:

- There is heavy rain, snow or fog.
- The light conditions are poor, e.g. at night.
- The area is lit by fluorescent light (the display may flicker).
- If there is a sudden change in temperature, e.g. when driving into a heated garage in winter.
- The ambient temperature is very high.
- The camera lens is obstructed, dirty or misted up. Observe the notes on cleaning the reversing camera (→ page 287).
- The camera or rear of your vehicle is damaged. In this event, have the camera, its position and its setting checked at a qualified specialist workshop.

The field of vision and other functions of the reversing camera may be restricted due to additional accessories on the rear of the vehicle (e.g. a loading tailgate).

- i** The display contrast may be impaired due to incident sunlight or other light sources. In this case, pay particular attention.
- i** Have the display repaired or replaced if, for example, pixel errors considerably restrict its use.
- i** Objects that are not at ground level appear further away than they actually are. This includes, for example:
 - The bumper of a vehicle parked behind.
 - The drawbar of a trailer.
 - The ball neck of a trailer coupling.
 - The rear end of a lorry.

- Slanted posts.

Only use the guide lines of the camera image for orientation. Do not travel further than the lowest horizontal guide line when approaching objects. You may otherwise damage your vehicle and/or the object.

Vehicles without Parking Assist PARKTRONIC

The following camera views are available in the multimedia system:

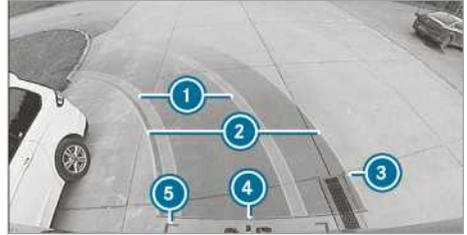

Normal view

- 1** Yellow lane marking the course the tyres will take at the current steering wheel angle (dynamic)
- 2** Yellow guide line, vehicle width (driven surface) depending on the current steering wheel angle (dynamic)
- 3** Marking at a distance of approximately 1.0 m (the rear doors can still be opened completely)
- 4** Red guide line at a distance of approximately 0.3 m from the rear area
- 5** Red guide line at a distance of approximately 0.2 m from the rear area, vehicle width with outside mirror



Wide-angle view

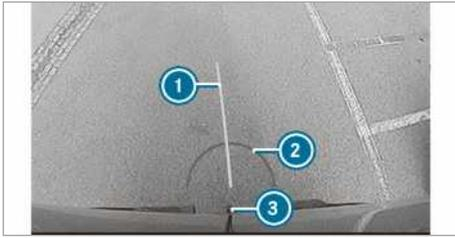

View of trailer (if trailer hitch is fitted)

- ① Yellow guide line, locating aid
- ② Red guide line at a distance of approximately 0.3 m from the ball head of the trailer hitch
- ③ Ball head of the trailer hitch

Vehicles with Parking Assist PARKTRONIC

The following camera views are available in the multimedia system:

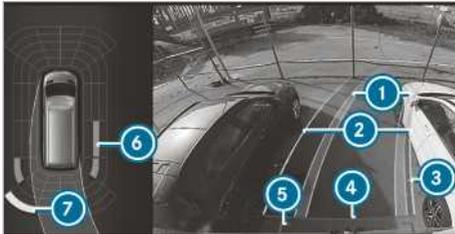

Normal view

- ① Yellow lane marking the course the tyres will take at the current steering wheel angle (dynamic)
- ② Yellow guide line, vehicle width (driven surface) depending on the current steering wheel angle (dynamic)
- ③ Marking at a distance of approximately 1.0 m (the rear doors can still be opened completely)
- ④ Red guide line at a distance of approximately 0.3 m from the rear area
- ⑤ Red guide line at a distance of approximately 0.2 m from the rear area, vehicle width with outside mirror
- ⑥ Orange warning display of Parking Assist PARKTRONIC: obstacles are a medium distance away (between approximately 0.4 m and 0.6 m)
- ⑦ Yellow warning display of Parking Assist PARKTRONIC: obstacles are at a distance of between approximately 0.6 m and 1.0 m

ⓘ If the distance to the obstacle is less than approx. 0.4 m, the warning display of Parking Assist PARKTRONIC will be red.

ⓘ If the entire system fails, the inner segments of the warning display are shown in red.

If the system fails at the rear, the display of the segments changes as follows:

- The rear segments are shown in red when reversing.
- The rear segments are hidden when driving forwards.

If Parking Assist PARKTRONIC is deactivated, the warning display fades out.



Wide-angle view

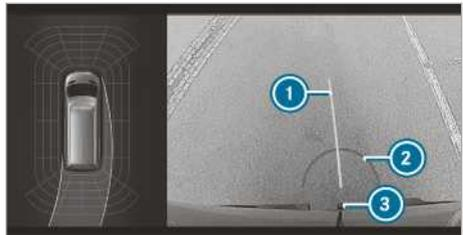

View of trailer (if trailer hitch is fitted)

- ① Yellow guide line, locating aid
- ② Red guide line at a distance of approximately 0.3 m from the ball head of the trailer hitch
- ③ Ball head of the trailer hitch

360° Camera

Function of the 360° Camera

The 360° Camera is a system that consists of four cameras. The cameras cover the immediate vehicle surroundings. The system assists you, e.g. when parking or at exits with reduced visibility.

The 360° Camera is only an aid. It is not a substitute for your attention to the surroundings. The

responsibility for safe manoeuvring and parking remains with you. Make sure that there are no persons, animals or objects etc., in the manoeuvring area while manoeuvring and parking.

The system evaluates images from the following cameras:

- Reversing camera
- Front camera
- Two side cameras in the outside mirrors

Views of the 360° Camera

You can select from different views:

Top view



- ① Yellow lane marking the course the tyres will take at the current steering wheel angle (dynamic)
- ② Yellow guide line, vehicle width (driven surface) depending on the current steering wheel angle (dynamic)
- ③ Marking at a distance of approximately 1.0 m (the rear doors can still be opened completely)
- ④ Red guide line at a distance of approximately 0.3 m from the rear area
- ⑤ Red guide line at a distance of approximately 0.2 m from the rear area, vehicle width with outside mirror
- ⑥ Red warning display of Parking Assist PARKTRONIC: obstacles at a distance of approximately 0.4 m or less

When Parking Assist PARKTRONIC is operational and no object is detected, the segments of the warning display are shown in grey.

- ① If the entire system fails, the segments of the warning display are shown in red.

If the system fails at the rear, the display of the segments changes as follows:

- The rear segments are shown in red when reversing.

- The rear segments are hidden when driving forwards.

If Parking Assist PARKTRONIC is deactivated, the warning display fades out.

Guide lines

- ① The guide lines in the multimedia system display show the distances to your vehicle. The distances only apply to road level. In trailer mode, the guide lines are shown at the level of the trailer hitch.

View of trailer (if trailer hitch is fitted)

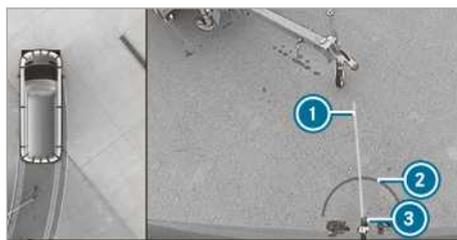

View of trailer (if trailer hitch is fitted)

- ① Yellow guide line, locating aid
- ② Red guide line at a distance of approximately 0.3 m from the ball head of the trailer hitch
- ③ Ball head of the trailer hitch

Side view of the mirror cameras

The sides of the vehicle can be seen in this view.

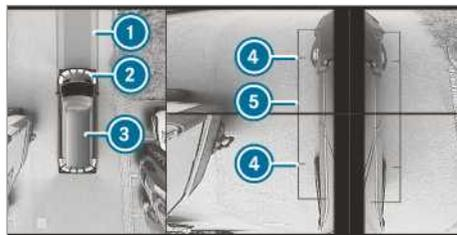

- ① Lane indicating the route the vehicle will take with the steering wheel in its current position
- ② Yellow warning display of Parking Assist PARKTRONIC: obstacles at a distance of approximately 1.0 m or less
- ③ Your vehicle from above
- ④ Marker of the wheel contact points
- ⑤ Guide line of external vehicle dimensions with outside mirrors folded out

If the distance to the object lessens, the colour of warning display ② changes.

System failure

If there is no operational readiness, the following message appears in the multimedia system:



System limitations

The 360° Camera will not function or will only partially function in the following situations:

- The front doors are open.
- The side mirrors are folded in.
- There is heavy rain, snow or fog.
- The light conditions are poor, e.g. at night.
- The area is lit by fluorescent light (the display may flicker).
- If there is a sudden change in temperature, e.g. when driving into a heated garage in winter.
- The ambient temperature is very high.
- The camera lens is obstructed, dirty or misted up.
- Cameras, or vehicle components in which the cameras are fitted, are damaged. In this event, have the cameras, their positions and their setting checked at a qualified specialist workshop.

Do not use the 360° Camera under such circumstances. You could otherwise injure others or collide with objects when parking the vehicle.

On vehicles with height-adjustable suspension or if the vehicle is carrying a heavy load, leaving the standard height can result in inaccuracies in the guide lines and in the display of the generated images, depending on technical conditions.

The field of vision and other functions of the camera system may be restricted due to additional attachments on the vehicle (e.g. loading tailgate).

- ⓘ The contrast of the display may be impaired by abrupt direct sunlight or by other light sources, e.g. when driving out of a garage. In this case, pay particular attention.

- ⓘ Have the display repaired or replaced if, for example, pixel errors considerably restrict its use.

The image from the 360° Camera appears automatically in the multimedia system when the following conditions are fulfilled:

- The ignition is switched on.
- The rear doors are opened.

This means that the area behind the vehicle can be monitored.

When the rear doors are closed, the image from the reversing camera is switched off after approximately ten seconds.

See the notes on cleaning the 360° Camera (→ page 287).

Selecting a view for the 360° Camera

Requirements:

- The **Auto reversing camera** is activated in the multimedia system (→ page 167).

- ▶ Engage reverse gear.
- ▶ Select the desired view in the multimedia system.

Activating/deactivating automatic operation of the reversing camera

The reversing camera is only an aid. It is not a substitute for you paying attention to the surroundings. You are always responsible for safe manoeuvring, parking and exiting of a parking space. Make sure that no persons, animals or objects etc. are in the path of your vehicle. Pay attention to your surroundings and be ready to brake at all times.

Multimedia system:

- ▶ ▶ Settings ▶ Assistance
- ▶ Camera & parking

- ▶ Activate or deactivate **Auto reversing camera**.

Activating/deactivating manoeuvring assistance

Multimedia system:

- ▶ ▶ Settings ▶ Assistance
- ▶ Camera & parking

- ▶ Activate or deactivate **Manoeuvring assist..**

- ⓘ When manoeuvring assistance is activated, the following functions are active:
 - Drive Away Assist (→ page 171)
 - Rear Cross Traffic Alert (→ page 172)

ATTENTION ASSIST

Function of ATTENTION ASSIST

ATTENTION ASSIST can assist you on long, monotonous journeys, e.g. on motorways and trunk roads. If ATTENTION ASSIST detects indicators of fatigue or increased lapses in concentration on the part of the driver, it suggests taking a break.

ATTENTION ASSIST is only an aid. It cannot always detect drowsiness or increased lapses in concentration in good time. The system is not a substitute for a well-rested and attentive driver. On long journeys, take regular and timely breaks that allow you to rest properly.

You can choose between two settings:

- **Standard:** normal system sensitivity
- **Sensitive:** higher system sensitivity. The driver is warned earlier and the attention level detected by the system (Attention Level) is adapted accordingly.

If fatigue or increased lapses in concentration are detected, the **ATTENTION ASSIST: Take a break!** warning appears in the Instrument Display. You can acknowledge the message and take a break if necessary. If you do not take a break and ATTENTION ASSIST continues to detect increased lapses in concentration, you will be warned again after a minimum of 15 minutes.



Instrument display (colour display)

You can have the following status information for ATTENTION ASSIST displayed in the Assistance menu of the on-board computer:

- the journey length since the last break
- the attention level determined by ATTENTION ASSIST:
 - the fuller the circle is, the higher the detected attention level is
 - the circle in the centre of the display empties from the outside inwards as attentiveness decreases

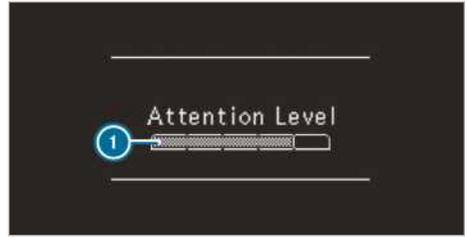

Instrument Display (black and white display)

You can have the following status information for ATTENTION ASSIST displayed in the Assistance menu of the on-board computer:

- the journey length since the last break
- the attention level determined by ATTENTION ASSIST:
 - the fuller the bar is, the higher the detected attention level is
 - the bar empties as attentiveness decreases

If ATTENTION ASSIST cannot calculate the attention level and cannot issue a warning, the **Attention level** message appears.

If a warning is displayed in the instrument display, the multimedia system offers to search for a rest area. You can select a rest area and start navigation to this rest area. This function can be activated and deactivated in the multimedia system.

If ATTENTION ASSIST is deactivated, the  symbol appears in the assistance graphic in the instrument display when the engine is running. ATTENTION ASSIST is activated automatically when the engine is re-started. The last selected sensitivity level remains stored.

System limitations

ATTENTION ASSIST is active in the 60 km/h to 200 km/h speed range.

The functionality of ATTENTION ASSIST is restricted, and warnings may be delayed or not occur at all, in the following situations:

- the journey lasts less than approximately 30 minutes
- the road condition is poor (uneven road surface or potholes)
- the vehicle is subjected to a strong crosswind
- you have a sporty driving style (high cornering speeds or high rates of acceleration)
- the time is set incorrectly

- you change lanes and vary your speed frequently in active driving situations

The ATTENTION ASSIST drowsiness or alertness assessment is deleted and restarted when continuing the journey in the following situations:

- if you switch off the engine
- if you unfasten your seat belt and open the driver's door (e.g. change drivers or take a break)

Setting ATTENTION ASSIST

Multimedia system:

→  >> Settings >> Assistance
>> Attention Assist

Setting options

▶ Select **Standard**, **Sensitive** or **Off**.

Suggesting a rest area

- ▶ Select **Suggest rest area**.
- ▶ Activate or deactivate the function. If ATTENTION ASSIST detects fatigue or an increasing lack of attention, it suggests a nearby rest area.
- ▶ Select a suggested rest area. You are guided to the selected rest area.

Traffic Sign Assist

Function of Traffic Sign Assist

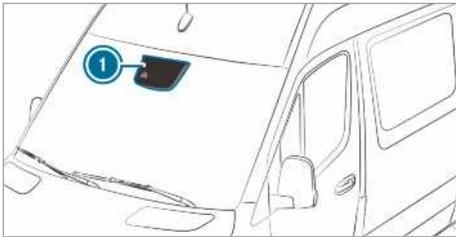

Traffic Sign Assist detects traffic signs with multi-function camera ①. It assists you by displaying detected speed limits and overtaking restrictions in the instrument cluster.

Since Traffic Sign Assist also uses the data stored in the navigation system, it can also update the display without detecting traffic signs:

- when the vehicle changes roads, e.g. motorway exit or slip road
- when a village or town boundary stored in the digital map is passed

If the system detects that you are driving onto a section of road in the wrong direction of travel, it triggers a warning.

The camera also detects traffic signs with a restriction indicated by an additional sign (e.g. in wet conditions).

Warning when the maximum permissible speed is exceeded

The system can warn you if you unintentionally exceed the maximum permissible speed. To do this, you can specify in the multimedia system by how much the maximum permissible speed can be exceeded before a warning is issued. You can specify whether the warning is to be just a visual warning or an audible one as well.

Display in the instrument display

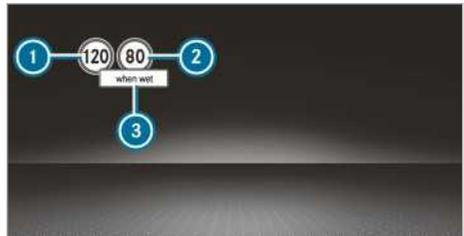

Instrument display (colour display)

- ① Permissible speed
- ② Permissible speed when there is a restriction
- ③ Additional sign with a restriction
- i Only one of traffic signs ① or ② is displayed at any one time in the instrument display, if necessary with additional sign ③. If two valid traffic signs are detected at the same time, a plus sign appears next to the traffic sign in the instrument display as an indication that both traffic signs are displayed in the navigation system.

Since Traffic Sign Assist also uses the data stored in the navigation system, it can also update the display without detecting traffic signs:

- when the vehicle changes roads, e.g. motorway exit or slip road
- when a village or town boundary stored in the digital map is passed

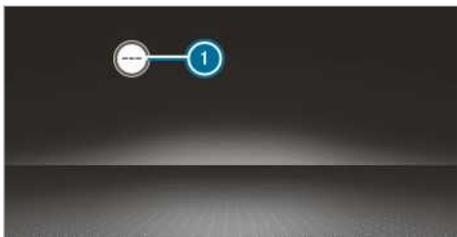

Traffic Sign Assist is not available in all countries. If it is unavailable, display ① is shown in the speedometer.

System limitations

The system may be impaired or may not function in the following situations:

- The system is affected by poor visibility, e.g. due to insufficient illumination of the road, highly variable shade conditions, or due to rain, snow, fog or heavy spray
- The system is impaired by glare, e.g. from oncoming traffic, direct sunlight or reflections
- The system is affected by dirt on the windscreen in the area of the multifunction camera, or because the camera is misted up, damaged or covered
- The traffic signs are hard to detect, e.g. due to dirt, because they are covered, due to snow or insufficient lighting
- The information in the navigation system's digital map is incorrect or out-of-date
- The system is affected by ambiguous signs, e.g. traffic signs on construction sites or in adjacent lanes

Setting Traffic Sign Assist

Multimedia system:

- ▶ ▶ Settings ▶ Assistance
- ▶ Traffic Sign Assist

Displaying detected traffic signs in the media display

- ▶ Select [Display in head unit](#).
- ▶ Activate or deactivate the function.

Setting the type of warning

- ▶ Select [Visual & audible](#), [Visual](#) or [None](#).

Setting the warning threshold

This value determines at which point the warning is given once a speed limit is exceeded.

- ▶ Select [Warning threshold](#).
- ▶ Set a speed.

Blind Spot Assist

Function of Blind Spot Assist with exit warning

Blind Spot Assist uses two lateral, rear-facing radar sensors to monitor the area directly next to and on the side behind the vehicle.

▲ WARNING Risk of accident despite Blind Spot Assist

Blind Spot Assist reacts neither to stationary objects nor to vehicles approaching and overtaking you at a greatly different speed.

As a result, Blind Spot Assist cannot warn drivers in these situations.

- ▶ Always pay careful attention to the traffic situation and maintain a safe distance at the side of the vehicle.

Blind Spot Assist is only an aid. It may fail to detect some vehicles and is no substitute for attentive driving. Always ensure that there is sufficient distance to the side for other road users and obstacles.

If a vehicle is detected above speeds of approximately 12 km/h and this vehicle subsequently enters the monitoring range directly next to your vehicle, the warning lamp in the outside mirror lights up red.

- ① When a trailer is connected, the radar sensor's field of vision may be impaired, thereby making limited monitoring possible. Always pay careful attention to the traffic situation and maintain a safe distance at the side of the vehicle.

If a vehicle is detected close to your vehicle in the lateral monitoring range and you switch on the turn signal indicator in the corresponding direction, a warning tone sounds. The red warning lamp in the outside mirror flashes. If the turn signal indicator remains switched on, all other detected vehicles are indicated only by the flashing of the red warning lamp.

If you overtake a vehicle quickly, no warning is given.

Exit warning

The exit warning is an additional function of Blind Spot Assist and warns vehicle occupants when

leaving the vehicle about any approaching vehicles.

⚠ WARNING Risk of accident despite exit warning

The exit warning reacts neither to stationary objects nor to vehicles approaching you at a greatly different speed.

As a result, the exit warning cannot warn drivers in these situations.

- ▶ Always pay particular attention to the traffic situation when opening the doors and make sure there is sufficient clearance.

- ⓘ An exit warning is not issued for sliding doors and rear-end doors.

Overview

When the vehicle is stationary, an object is detected from behind in the monitoring range.	Display in outside mirror
When the vehicle is stationary, a door on the relevant side of the vehicle is opened. An object which is close to your vehicle is detected in the monitoring range.	Visual and audible warning

- ⓘ This additional function is only available when Blind Spot Assist is activated and up to a maximum of three minutes after the ignition has been switched off. The end of the availability of the exit warning function is indicated by a series of flashes in the outside mirror.

The exit warning function is only an aid and is no substitute for the attentiveness of the vehicle occupants. Responsibility always lies with the vehicle occupants when opening doors and leaving the vehicle.

System limitations

Blind Spot Assist and the exit warning function may be limited in the following situations:

- if there is dirt on the sensors or the sensors are obscured
- if there is poor visibility, e.g. due to fog, heavy rain, snow or spray

- if narrow vehicles are within the monitoring range, e.g. bicycles

- ⓘ Stationary or slowly moving objects are not displayed.

Warnings may be issued in error when driving close to crash barriers or similar solid lane borders. Warnings may be interrupted when driving alongside long vehicles, for example lorries, for a prolonged time.

Blind Spot Assist is not operational when reverse gear is engaged.

The exit warning function may be limited in the following situations:

- when the sensor is blocked by adjacent vehicles in narrow parking spaces
- when people are approaching

Activating/deactivating Blind Spot Assist

Multimedia system:

→  → Settings → Assistance

- ▶ Activate or deactivate [Blind Spot Assist](#).

Function of Drive Away Assist

- ⓘ Drive Away Assist is only available for vehicles with automatic transmission.

Drive Away Assist can reduce the severity of an impact when pulling away. If an obstacle is detected in the direction of travel, the vehicle's speed is briefly reduced to approx. 2 km/h. If a critical situation is detected, a symbol appears on the camera image of the multimedia system.

⚠ WARNING Risk of accident caused by limited detection performance of Drive Away Assist

Drive Away Assist cannot always clearly identify objects and traffic situations.

In such cases, Drive Away Assist might:

- Warn you without reason and limit the vehicle speed.
- Not warn you or not limit the vehicle speed.

▶ Always pay careful attention to the traffic situation; do not rely on Drive Away Assist alone.

▶ Be prepared to brake or swerve as necessary, provided the traffic situation

permits and that it is safe to take evasive action.

Drive Away Assist is only an aid. It is not a substitute for your attention to the surroundings. The responsibility for safe manoeuvring and parking remains with you. Make sure that no persons, animals or objects etc. are in the manoeuvring range.

A risk of a collision may arise in the following situations, for example:

- If the driver mixes up the accelerator and brake pedals.
- If the wrong gear is selected.

The Drive Away Assist function is active under the following conditions:

- If Parking Assist PARKTRONIC is activated.
- Every time the gear is changed to **R** or **D** when the vehicle is at a standstill.
- If the detected obstacle is less than approx. 1.0 m away.
- If the manoeuvring assistance function is activated in the multimedia system.

System limitations

Drive Away Assist is not available on inclines and when driving with a trailer.

Function of Rear Cross Traffic Alert

The radar sensors in the bumper are used for the system. This way the area adjacent to the vehicle is continually monitored. If the radar sensors are obscured by vehicles or other objects, detection is not possible.

i Also read the notes on Blind Spot Assist (→ page 170).

Vehicles with Blind Spot Assist: drivers can also be warned of any crossing traffic when reversing out of a parking space. If a vehicle is detected, the warning lamp in the outside mirror on the relevant side lights up red. If it detects a critical situation, a warning tone also sounds.

Vehicles with Blind Spot Assist and Parking Assist PARKTRONIC: drivers can also be warned of any crossing traffic when reversing out of a parking space. If a critical situation is detected, a warning symbol appears on the camera image of the multimedia system. If the driver does not respond to the warning, the vehicle's brakes can

be applied automatically. In this case, a warning tone sounds.

The Rear Cross Traffic Alert function is active under the following conditions:

- Blind Spot Assist is activated.
- Reverse gear is engaged or the vehicle is reversing at walking pace.
- If the manoeuvring assistance function is activated in the multimedia system.

The Rear Cross Traffic Alert function is unavailable when driving with a trailer.

Lane Keeping Assist and Active Lane Keeping Assist

Functions of Lane Keeping Assist

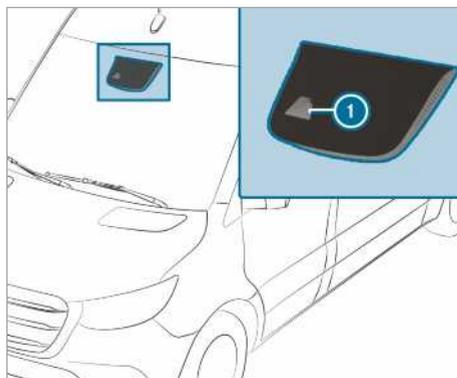

Lane Keeping Assist monitors the area in front of your vehicle with multifunction camera **1**. It serves to protect you against unintentionally leaving your lane. You may also be warned by a vibrating message from the steering wheel and by the status symbol flashing in the instrument display.

The warning is issued when the following conditions are met at the same time:

- Lane Keeping Assist detects lane markings.
- A front wheel passes over the lane markings.

You can activate and deactivate the Lane Keeping Assist warning.

If you fail to adapt your driving style, Lane Keeping Assist can neither reduce the risk of accident nor override the laws of physics. It cannot take into account road, weather or traffic conditions. Lane Keeping Assist is only an aid and is not intended to keep the vehicle in the lane without

the driver's cooperation. You are responsible for the distance to the vehicle in front, for vehicle speed, braking in good time and for staying in your lane.

System limitations

The system may be impaired or may not function in the following situations:

- There is poor visibility, e.g. due to insufficient illumination of the road, highly variable shade conditions, or due to rain, snow, fog or heavy spray.
- Dazzle from oncoming traffic, direct sunlight or reflections.
- There is dirt on the windscreen in the vicinity of the multifunction camera or the camera is misted up, damaged or obscured.
- No or several, unclear lane markings are present for one lane, e.g. in a construction area.
- The lane markings are worn, dark or covered.
- The distance to the vehicle in front is too small, and therefore the lane markings cannot be detected.
- The lane markings change quickly, e.g. lanes branch off, cross one another or merge.
- The carriageway is very narrow and winding.

Functions of Active Lane Keeping Assist

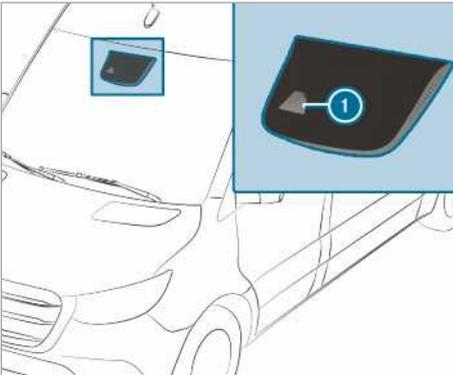

Active Lane Keeping Assist monitors the area in front of your vehicle by means of multifunction camera ①. It serves to protect you against unintentionally leaving your lane. You may also be warned by a vibrating message from the steering wheel and by the status symbol flashing in the instrument display. In addition, you may be guided back into your lane by a lane-correcting

brake application. A relevant message appears in the instrument display.

The warning is issued when the following conditions are met at the same time:

- The driving system detects lane markings.
- A front wheel passes over the lane markings.

A lane-correcting brake application occurs when the following conditions are met:

- Active Lane Keeping Assist detects lane markings on both sides of the vehicle.
- A front wheel drives over a solid lane marking.

A relevant message appears in the instrument display.

The brake application is available in the speed range between approximately 60 km/h and 160 km/h.

You can either deactivate the Active Lane Keeping Assist warning or switch off the system completely.

If you fail to adapt your driving style, Active Lane Keeping Assist can neither reduce the risk of an accident nor override the laws of physics. It cannot take into account road, weather or traffic conditions. The driving system is an aid for when you unintentionally leave or cross the lane and not a system for automatically keeping to the lane. You are responsible for the distance to the vehicle in front, for vehicle speed, braking in good time and for staying in your lane.



If a lane-correcting brake application from Active Lane Keeping Assist occurs, display ① appears in the multifunction display.

System limitations

No lane-correcting brake application from Active Lane Keeping Assist occurs in the following situations:

- You clearly and actively steer, brake or accelerate.

- You switch on the turn signal.
- A driving safety system intervenes, such as ESP® or Active Brake Assist.
- You have adopted a sporty driving style with high cornering speeds or high rates of acceleration.
- ESP® has been switched off.
- When driving with a trailer, the electrical connection to the trailer has been correctly established.
- If a loss of tyre pressure or a defective tyre has been detected and displayed.

The system may be impaired or may not function in the following situations:

- There is poor visibility, e.g. due to insufficient illumination of the road, highly variable shade conditions, or due to rain, snow, fog or heavy spray.
- Dazzle from oncoming traffic, direct sunlight or reflections.
- There is dirt on the windscreen in the vicinity of the multifunction camera or the camera is misted up, damaged or obscured.
- No or several, unclear lane markings are present for one lane, e.g. in a construction area.
- The lane markings are worn, dark or covered.
- The distance to the vehicle in front is too small, and therefore the lane markings cannot be detected.
- The lane markings change quickly, e.g. lanes branch off, cross one another or merge.
- The carriageway is very narrow and winding.

Activating/deactivating Lane Keeping Assist or Active Lane Keeping Assist

Multimedia system:

➔  ➔ Settings ➔ Assistance

- ▶ Select **Lane Keeping Assist** or **Act. Lane Keep. Asst On**.

Activating or deactivating warning

- ▶ Select **Lane Keeping Assist** or **Act. Lane Keep. Asst On**.
- ▶ Select **Warning**.

Work mode

Activating/deactivating power take-off

Observe the following notes:

- if there is severe strain on the power take-off, e.g. due to a high power draw at high outside temperatures, the transmission oil temperature can increase to impermissible levels. In this case, operate the power take-off at regular intervals for about five to ten minutes under a partial load.
- only activate the power take-off when the vehicle is stationary and the transmission is in neutral position.
- make sure that the engine speed is not higher than 2500 rpm during operation.
- manual transmission is disabled in vehicles with shift lock when the power take-off is activated.
- you can engage 1st or 2nd gear and drive after activating power take-off in vehicles without shift lock. Do not change gear while the vehicle is in motion when power take-off is activated. Therefore, pull away in 1st or 2nd gear depending on the desired speed.
- observe the notes in the manufacturer's operating instructions before using the power take-off in conjunction with the body.

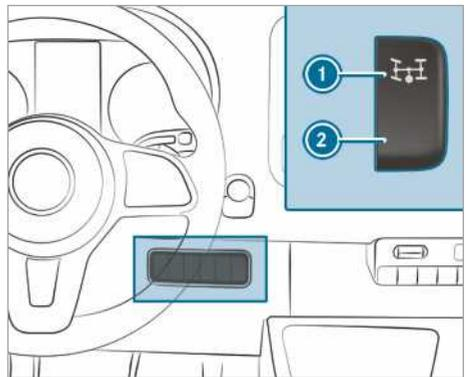

- ▶ **To activate:** stop the vehicle and shift the transmission to neutral.
 - ▶ depress the clutch pedal.
 - ▶ wait about five seconds and with the engine running press the upper section of the switch ①.
 - ▶ release the clutch pedal.
- On vehicles with a working speed governor (ADR), the engine speed automatically increases to a preset speed or a speed you have set, the constant engine speed. The **Working speed governor active** and **Power-take off**

active messages are shown in the multifunction display.

- ▶ **To deactivate:** stop the vehicle and shift the transmission to neutral.
- ▶ depress the clutch pedal.
- ▶ wait about five seconds and with the engine running press the lower section of the switch ②.
- ▶ release the clutch pedal.

ADR (working speed control)

Function of ADR (working speed control)

When activated, ADR automatically increases the engine speed to a preset speed or a speed you have set.

- ① After a cold start, the idle speed of the engine is increased automatically. If the preset working speed is lower than the increased idle speed, the working speed is only reached once the engine has completed the warm-up phase.

It is only possible to activate ADR with the vehicle stationary and the parking brake applied.

On vehicles with automatic transmission, the selector lever must be in position **P**.

Activating/deactivating ADR

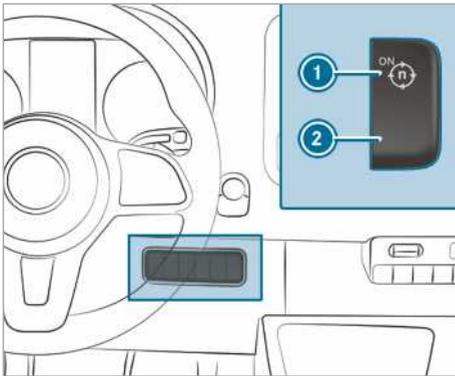

- ▶ **To activate:** while the engine is running, press switch ①. The **Working speed governor active** message appears in the multifunction display.
- ▶ **To deactivate:** while the engine is running, press switch ②.

The ADR goes out automatically in the following situations:

- you release the parking brake.
- you depress the brake pedal.
- the vehicle moves.
- the control unit detects a malfunction.

Adjusting ADR

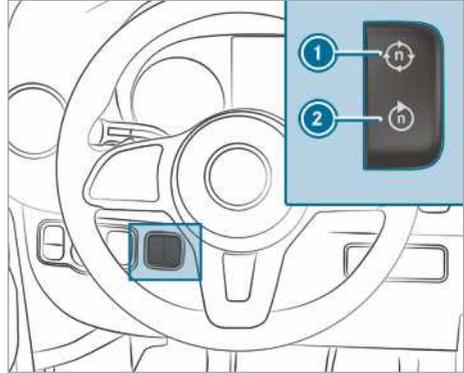

- ▶ Engage power take-off (→ page 174) or activate ADR.
- ▶ **To increase:** press the switch ①.
- ▶ **To reduce:** press the switch ②.

Trailer operation

Notes on towing a trailer

- ▲ **WARNING** Risk of accident- and injury if the load is exceeded

If you exceed the permitted load when using the rack, the rack system may disconnect from the vehicle and endanger other road users.

- ▶ Always comply with the permitted load when using the rack.

- ▲ **WARNING** Swerving of the car/trailer combination due to increased speed

If the car/trailer combination swerves, you can lose control of it.

The car/trailer combination can even tip over.

- ▶ Under no circumstances should you try to increase the speed to straighten the car/trailer combination.

- ▶ Reduce speed and do not counter-steer.
- ▶ If necessary, apply the brakes.

⚠ WARNING Risk of accident due to the brake system overheating

If you leave your foot on the brake pedal when driving, the brake system may overheat.

This increases the braking distance and the brake system may even fail.

- ▶ Never use the brake pedal as a footrest.
- ▶ Do not depress the brake pedal and the accelerator pedal at the same time while driving.

! NOTE Causing wear to the brake linings by permanently depressing the brake pedal

- ▶ Do not permanently depress the brake pedal while driving.
- ▶ To use braking effect of the engine, shift to a lower gear in good time.

If the trailer coupling is removable, it is essential to comply with the operating instructions of the trailer coupling manufacturer.

Place your vehicle/trailer combination on surfaces that are as even as possible and secure it against rolling away (→ page 146). Couple and uncouple the trailer carefully.

When reversing the towing vehicle, ensure that there is no-one between the vehicle and the trailer.

If you do not connect the trailer to the towing vehicle correctly, the trailer may become detached. Once it has been connected and is roadworthy, the trailer must be in a horizontal position behind the towing vehicle.

Note the following regarding the tongue weight:

- Make full use of the maximum tongue weight, where possible
- Do not exceed or fall below the permitted tongue weight

Do not exceed the following values:

- Permitted braked or unbraked towing capacity
The maximum permissible towing capacity for trailers without a separate braking system is 750 kg.

- Permissible rear axle load of the towing vehicle
- Permissible gross mass of the towing vehicle
- Permissible gross mass of the trailer
- Permissible gross towing mass
- Maximum permissible speed of the trailer

The relevant permitted values, which must not be exceeded, can be found in the following places:

- In your vehicle documents
- On the identification plate of the trailer hitch
- On the trailer's identification plate
- On the vehicle identification plate

If there are discrepancies between the values, the lowest one shall apply.

Before driving off, ensure the following:

- The tyre pressure on the rear axle of the towing vehicle has been set for the maximum load.
- The headlamps have been set correctly.

Your vehicle will act differently with a trailer relative to without a trailer:

- The vehicle/trailer combination will be heavier.
- The vehicle/trailer combination will be restricted in its acceleration and climbing ability.
- The vehicle/trailer combination will have an increased braking distance.
- The vehicle/trailer combination will be more susceptible to crosswind gusts.
- The vehicle/trailer combination will require more sensitive steering.
- The vehicle/trailer combination will have a larger turning circle.

This may impair the vehicle's driving characteristics.

When driving with a vehicle/trailer combination, always adapt your speed to the current road and weather conditions. Drive carefully. Keep a sufficient safe distance.

Comply with the maximum speed of 80 km/h or 100 km/h, even in countries in which higher speeds are permitted for vehicle/trailer combinations.

Comply with the legally prescribed maximum speed for vehicle/trailer combinations in force in

the country in question. Before driving, consult the trailer's vehicle documents to see the maximum permissible speed for your trailer.

The trailer hitch is one of the most important vehicle parts for road safety. Comply with the instructions on operating, maintaining and servicing in the manufacturer's operating instructions.

- ① When using a trailer, remember that PARKTRONIC is available only to a limited extent, if at all.
- ② The ball head height will change depending on the vehicle's load. In this case, use a trailer with a height-adjustable drawbar.

Driving notes

The maximum permissible speed for vehicle/trailer combinations depends on the type of trailer. Before driving, consult the trailer's vehicle documents to see the maximum permissible speed for your trailer.

Your vehicle will act differently with a trailer relative to without a trailer, and will consume more fuel. In the case of a long and steep descent, you must select shift range **3**, **2** or **1** in good time.

- ③ This also applies if the cruise control or the speed limiter is switched on.

You will thereby make use of the engine's braking effect and will not have to brake as often to control the speed. This will take some of the strain off the brake system and prevent the brakes from overheating and wearing too quickly. If you need additional braking, depress the brake pedal intermittently rather than continuously.

Driving tips

If the trailer sways, remember the following points:

- Do not accelerate under any circumstances.
- Do not countersteer.
- If necessary, apply the brakes.
- ④ You can prevent the trailer from swaying and rocking by retrofitting stabiliser bars or trailer stability programs. You can obtain further information from a Mercedes-Benz service centre.
- Maintain a larger distance than when driving without a trailer.
- Avoid braking abruptly. If possible, brake gently first of all so that the trailer closes up behind your vehicle. Then, increase the braking force rapidly.

- The values given for start-off gradeability refer to sea level. When driving in mountainous areas, note that engine output, and therefore start-off gradeability, will decrease with increasing altitude.

Attaching the ball coupling

▲ WARNING Danger of accident- and injury due to incorrectly installed and secured ball coupling

If the ball coupling has not engaged, it can become detached during driving and endanger other road users.

- ▶ Engage the ball coupling as described and ensure that it is securely installed.

▲ WARNING Danger of accident due to non-engaged ball coupling

If the ball coupling has not engaged, the trailer can become detached.

- ▶ Always engage the ball coupling as described and ensure that it is securely installed.

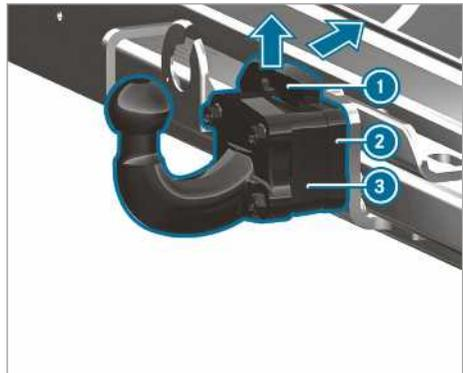

- ▶ Use the parking brake to secure the vehicle against rolling away.
- ▶ Pull safety spring ① of ball coupling ③ upwards in the direction of the arrow, push it backwards and hold it in this position.

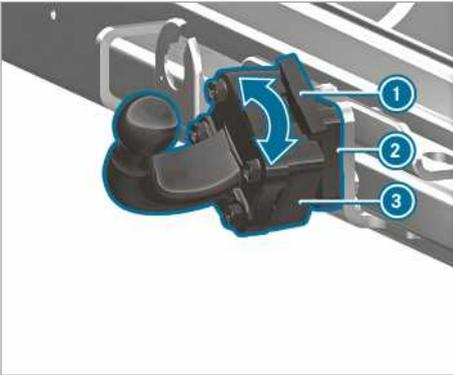

- ▶ Place ball coupling ③ onto ball coupling mount ② and turn it in the direction of the arrow until ball coupling ③ points vertically upwards.
- ▶ Re-attach safety spring ①.
- ⓘ If the ball coupling is dirty, clean it before installation.

Detaching the ball neck

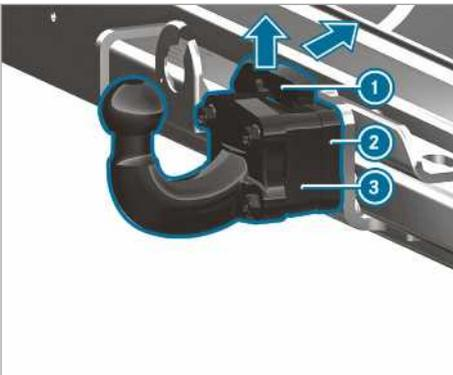

- ▶ Use the parking brake to secure the vehicle against rolling away.
- ▶ Pull the safety spring ① upwards in the direction of the arrow and push it to the rear.
- ▶ Hold the ball neck ③ in place.
- ▶ Turn the ball neck ③ in the direction of the arrow and remove it from the ball neck mount ②.
- ▶ Place the plastic covering on the ball neck mount ②.
- ▶ If the ball neck is dirty, clean it.

- ▶ Place the cover on the ball head.
- ▶ Stow and secure the ball neck properly.

Coupling/uncoupling a trailer

Requirements:

- The ball neck must be engaged in a securely locked position.

Trailers with 7-pin plugs can be connected to the vehicle using the following adapters:

- Adapter plug
- Adapter cable

Coupling a trailer

! **NOTE** Damage to the vehicle battery due to full discharge

Charging the trailer battery using the power supply of the trailer can damage the vehicle battery.

- ▶ Do not use the vehicle's power supply to charge the trailer battery.

▶ **Vehicles with automatic transmission:** shift the selector lever to position **P**.

- ▶ Apply the vehicle's parking brake.
- ▶ Close all the doors.
- ▶ Remove the cover cap from the ball head and stow it away safely (→ page 77).

ⓘ The ball head height changes depending on the vehicle's load. In this case, use a trailer with a height-adjustable trailer drawbar.

- ▶ Attach the trailer's breakaway cable to the eyelet on the ball neck.
- ▶ Remove objects or devices which prevent the trailer from rolling, e.g. wheel chocks.
- ▶ Release the trailer's parking brake.
- ▶ Place the trailer in a horizontal position behind the vehicle and couple it.



- ▶ Open the cover of the socket.
- ▶ Insert the plug with the tab ❶ into the socket's groove ❸.
- ▶ Turn the bayonet coupling ❷ to the right as far as it will go.
- ▶ Let the cover engage.
- ▶ Attach the cable to the trailer with cable ties (only in the case of adapter cable).
- ▶ Ensure that the cable has unobstructed movement for driving around bends.
- ▶ Push the combination switch upwards/downwards and check whether the correct turn signal light is flashing on the trailer.

Even if the trailer is connected correctly, a display message will nevertheless appear on the multi-function display in the following cases:

- LEDs have been installed on the trailer's lighting system.
 - The minimum power (50 mA) of the trailer lighting is not reached.
- ❶ You can connect accessories up to a maximum of 240 W to the permanent power supply.

- ▶ Place the cover on the ball head.
- ❶ On vehicles with detachable trailer tow hitches: once the trailer has been uncoupled, remove the ball neck and place the plastic covering on the ball neck mount on the vehicle.

Uncoupling a trailer

⚠ WARNING Risk of being crushed and becoming trapped when uncoupling a trailer

When uncoupling a trailer with an engaged inertia-activated brake, your hand may become trapped between the vehicle and the trailer drawbar.

- ▶ Do not uncouple trailers with an engaged overrun brake.

Do not uncouple a trailer with an overrun brake in a state of overrun. Otherwise, the rebound of the overrun brake can damage your vehicle.

- ▶ **Vehicles with automatic transmission:** shift the selector lever to position **P**.
- ▶ Apply the vehicle's parking brake.
- ▶ Close all the doors.
- ▶ Apply the trailer's parking brake.
- ▶ Secure the trailer against rolling away with a wheel chock or similar object.
- ▶ Disconnect the electrical connection between the vehicle and trailer.
- ▶ Uncouple the trailer

Overview of instrument display

⚠ WARNING Risk of accident due to an instrument display malfunction

If the Instrument Display has failed or malfunctioned, you may not recognise function restrictions applying to safety relevant systems.

The operating safety of your vehicle may be impaired.

- ▶ Drive on carefully.
- ▶ Have the vehicle checked immediately at a qualified specialist workshop.

If your vehicle's operational safety is impaired, park the vehicle in a safe location immediately. Inform a qualified specialist workshop.

Instrument display

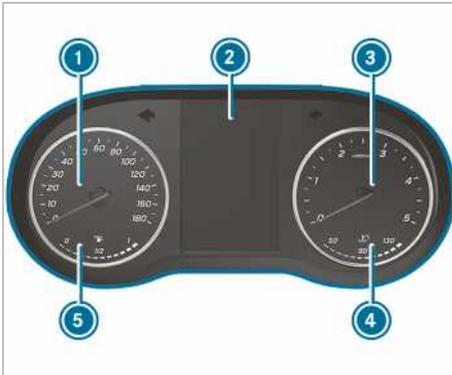

Instrument display with colour display (example)

- ① Speedometer
- ② Multifunction display
- ③ Rev counter
- ④ Coolant temperature display
- ⑤ Fuel level and tank cap position display

In normal driving mode, the coolant temperature display ④ is permitted to rise to 120 °C.

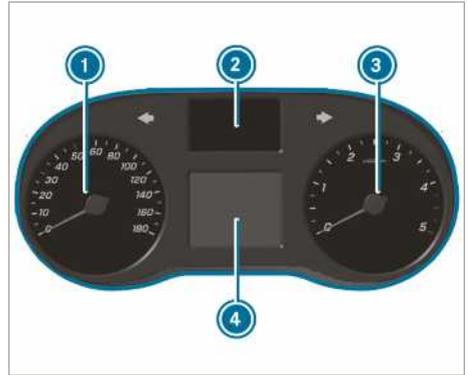

Instrument display with black and white display (example)

- ① Speedometer
- ② Indicator lamps display
- ③ Rev counter
- ④ Multifunction display

! NOTE Engine damage due to excessively high engine speeds

The engine will be damaged if you drive with the engine in the overrevving range.

- ▶ Do not drive with the engine in the overrevving range.

When the red marking in the rev counter ③ is reached (overspeed range), the fuel supply will be interrupted in order to protect the engine.

⚠ WARNING Danger of burns when opening the bonnet

If you open the engine bonnet when the engine has overheated or during a fire in the engine compartment, you could come into contact with hot gases or other escaping operating fluids.

- ▶ Before opening the bonnet, allow the engine to cool down.
- ▶ In the event of a fire in the engine compartment, keep the engine bonnet closed and call the fire service.

Overview of the buttons on the steering wheel

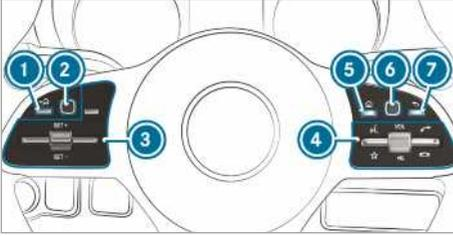

- ①  Back button, left (on-board computer)
- ②  Touch Control, left (on-board computer)
- ③  Button group for cruise control or Active Distance Assist DISTRONIC
- ④  Button group:
 -  Voice-operated control
 -  Display favourites (multimedia system)
 VOL: using the  control, increases/reduces the volume or switches off the sound
 -  Makes/accepts a call
 -  Rejects/ends a call
- ⑤  Main menu button (multimedia system)
- ⑥  Touch Control, right (multimedia system)
- ⑦  Back button, right (multimedia system)

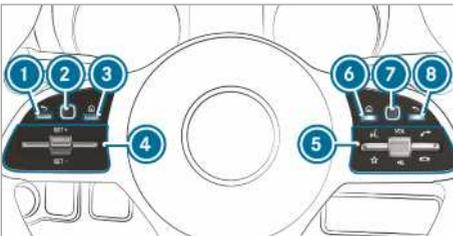

- ①  Back button, left (on-board computer)
- ②  Touch Control, left (on-board computer)
- ③  Main menu button (on-board computer)
- ④  Button group for cruise control or Active Distance Assist DISTRONIC
- ⑤  Button group:
 -  Voice-operated control
 -  Display favourites (multimedia system)
 VOL: using the  control, increases/reduces the volume or switches off the sound
 -  Makes/accepts a call

 Rejects/ends a call

- ⑥  Main menu button (multimedia system)
- ⑦  Touch Control, right (multimedia system)
- ⑧  Back button, right (multimedia system)

Operating the on-board computer

⚠ WARNING Risk of distraction from information systems and communications equipment

If you operate information and communication equipment integrated in the vehicle when driving, you will be distracted from the traffic situation. This could also cause you to lose control of the vehicle.

- ▶ Only operate this equipment when the traffic situation permits.
- ▶ If you cannot be sure of this, stop the vehicle whilst paying attention to road and traffic conditions and operate the equipment with the vehicle stationary.

You must observe the legal requirements for the country in which you are currently driving when operating the on-board computer.

Operating the on-board computer (vehicles with steering wheel buttons)

- ① The display of the on-board computer appears on the multifunction display (→ page 182).

When the function is switched on, different signal tones give feedback while the on-board computer is being operated. These include a signal tone when the end of a list is reached or when a list is being scrolled through.

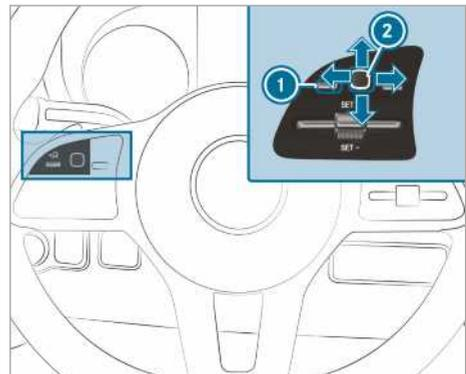

The on-board computer is operated via left-hand Touch Control ② and the back button on the left ①.

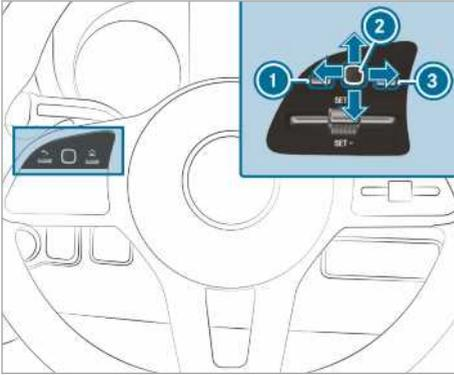

The on-board computer is operated using the following buttons:

- the back button on the left ①
- the left-hand Touch Control ②
- the main menu button on the left ③

The following menus are available:

- Service
- Assistance
- Trip
- Navigation
- Radio
- Media
- Telephone
- Settings

▶ **To call up the main menu:** press the back button on the left ① repeatedly, or press and hold it.

① **VEHICLES without Active Distance Assist DISTRONIC:** you can call up the main menu of the on-board computer with the  button.

▶ **To browse through the menu bar:** swipe to the left or right on left-hand Touch Control ②.

▶ **To call up a menu or confirm a selection:** press left-hand Touch Control ②.

▶ **To browse through displays or lists in the menu:** swipe upwards or downwards on left-hand Touch Control ②.

▶ **To call up a submenu or confirm a selection:** press left-hand Touch Control ②.

▶ **To exit a submenu:** press the back button on the left ①.

If you are in a submenu and press and hold the back button on the left ①, the main menu appears.

Overview of the displays on the multifunction display

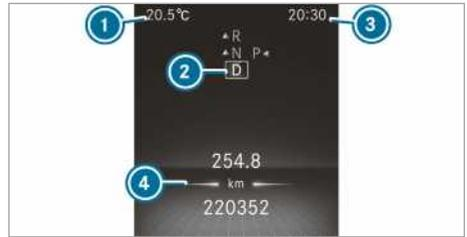

Instrument display with colour display

- ① Outside temperature
- ② Transmission position
- ③ Time
- ④ Display section



Instrument display with black and white display

- ① Outside temperature
- ② Display section
- ③ Time
- ④ Transmission position

Further displays on the multifunction display:

- ↑ Gearshift recommendation
-  Parking Assist PARKTRONIC switched off
-  Cruise control (→ page 157)
-  Active Distance Assist DISTRONIC (→ page 159)

- LIM** Speed limiter (→ page 157)
- DSR** DSR (→ page 134)
- (A)** ECO start/stop function (→ page 124)
- HOLD** HOLD function (→ page 162)
- (D)** Adaptive Highbeam Assist (→ page 88)
- 120 km/h!** Maximum permitted speed exceeded (for certain countries only)
- OFF** ATTENTION ASSIST deactivated
- (D)** A door is not fully closed.
- (W)** Rear window wiper switched on (→ page 97)
- LOW RANGE** LOW RANGE active (→ page 133)
- (R)** Retarder (see separate operating manual)

SOS NOT READY Emergency call system not active

- (LKA OFF)** Active Lane Keeping Assist switched off (→ page 173)
- (ABS OFF)** Active Brake Assist deactivated (→ page 155)
- (BSM OFF)** Blind Spot Assist switched off (→ page 170)

Vehicles with Traffic Sign Assist: detected traffic signs and messages (→ page 169).

Setting the instrument lighting

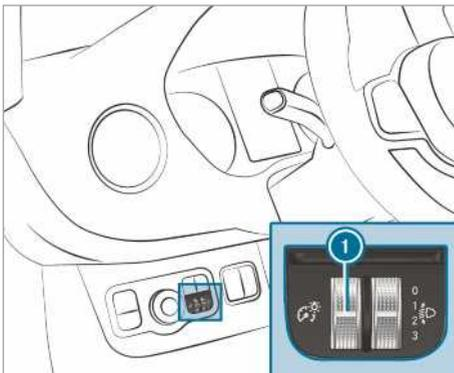

- ▶ Turn brightness control knob ① upwards or downwards.
The lighting on the instrument display and the control elements in the vehicle interior is set.
- ① In vehicles without brightness control knob ①, the instrument lighting can be set via the on-board computer (→ page 187).

Menus and submenus

Calling up functions on the service menu

On-board computer:

↳ Service

- ▶ Select and confirm the required function.

The following functions are available on the Service menu:

- **Messages:** message memory (→ page 360)
- **AdBlue:** Displays the AdBlue® range and level (→ page 142)
- **Tyres:**
 - Checks the tyre pressure with the tyre pressure monitoring system (→ page 328)
 - Restarts the tyre pressure monitoring system (→ page 329)
- **ASSYST PLUS:** calls up the service due date (→ page 278)
- **Engine oil level:** measures engine oil level
- **Consumption info:** starts regeneration (→ page 125)
- **Long-term consumption**

Calling up the assistant display

On-board computer:

↳ Assistance

- ▶ Select the desired display and confirm.

The following displays are available on the assistant display:

- Assistant display
- Attention level (→ page 168)
- ▶ Switch between the displays and confirm the selected display.

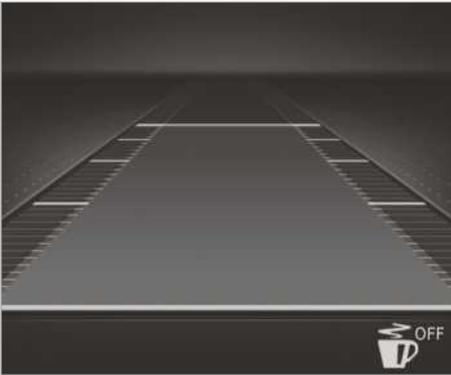

Instrument display with colour display

The following status displays are available on the assistant display:

- : ATTENTION ASSIST switched off
- Displays of the Active Distance Assist DISTRONIC (→ page 159)

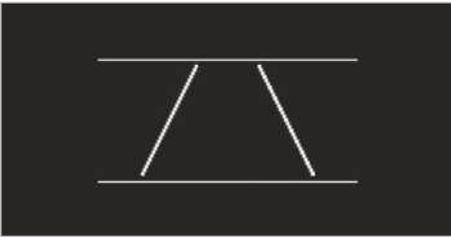

Instrument display with black and white display

The following status displays are available on the assistant display:

- Lane markings dotted: Lane Keeping Assist switched off
- Lane markings solid and thin: Lane Keeping Assist switched on, not ready to issue warnings
- Lane markings solid and thick: Lane Keeping Assist ready to issue warnings

Calling up displays on the trip menu

On-board computer:



- ▶ Select the desired display and confirm.

The following displays are available on the trip menu:

- Standard display

- Range and current fuel consumption
With certain engines a recuperation display is also shown. If only a small amount of fuel is left in the fuel tank, a vehicle being refuelled appears instead of the approximate range.
- ECO display (→ page 124)
- Trip computer:
 - From start
 - From reset
- Digital speedometer



Instrument display with colour display

Standard display (example)

- ① Trip distance
- ② Total distance



Instrument display with black and white display

Standard display (example)

- ① Trip distance
- ② Total distance

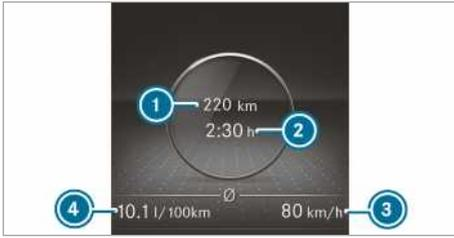

Instrument display with colour display
Trip computer (example)

- ① Distance covered (from start / from reset)
- ② Driving time (from start / from reset)
- ③ Average speed (from start / from reset)
- ④ Average fuel consumption (from start / from reset)

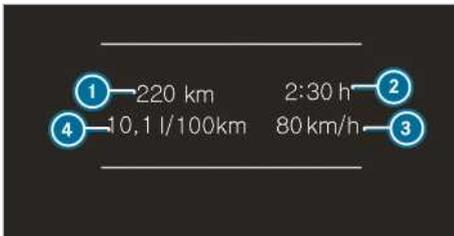

Instrument display with black and white display
Trip computer (example)

- ① Distance covered (from start / from reset)
- ② Driving time (from start / from reset)
- ③ Average speed (from start / from reset)
- ④ Average fuel consumption (from start / from reset)

Resetting values on the on-board computer trip menu

On-board computer:



Trip

- ⓘ The spelling of the displayed main menu may differ. Therefore, pay attention to the menu overview for the instrument display (→ page 181).

You can reset the values of the following functions:

- Trip meter:
 - Reset trip meter?
- Trip computer:
 - From start

- From reset

- ECO display



Select the function that is to be reset and confirm this selection.



Confirm the **Reset values?** prompt with **Yes**.

Calling up navigation instructions on the on-board computer

On-board computer:



Navigation



No change of direction announced (example)

- ① Distance to the next destination
- ② Estimated arrival time
- ③ Distance to the next change of direction
- ④ Name of current road



Change of direction announced (example)

- ① Street into which the change of direction leads
- ① Destination route of the change of direction
- ② Distance to the change of direction
- ③ Change of direction symbol
- ④ Recommended lane and the new lane that appears during the change of direction (white)
- ⑤ Possible lane
- ⑥ Unrecommended lane (dark grey)

Further possible displays are available on the Navigation menu:

- **Direction of travel:** The direction of travel and the road currently being travelled are displayed.
- **New route... or Calculating route...:** A new route is being calculated.
- **Road not mapped:** The road is not known, e.g. it has only recently been constructed.
- **No route:** The route to the selected destination cannot be calculated.
- **Off map:** The map for the current position is not available.
- **Area of destination reached:** You have reached the target area.
- **📍:** You have reached the destination or an intermediate destination.

▶ Exit the menu or select and confirm a destination.

If a destination is entered and confirmed, route guidance starts.

▶ If route guidance was previously active, a query appears whether the current route guidance is to be terminated.

▶ Confirm the prompt.
Route guidance is started.

Selecting a radio station

On-board computer:

➔ Trip



- 1 Frequency range
- 2 Station
- 3 Name of the track
- 4 Artist's name

The following displays are available:

- Frequency range
- Station list

▶ Select the radio station's frequency or a radio station from the station list.

▶ Confirm the selection.

When you select a station in the station memory, the storage location appears beside the station name. When you select a saved station in the frequency range, a star appears beside the station name.

Operating media playback with the on-board computer

On-board computer:

➔ Media



- 1 Media source
- 2 Current track and track number
- 3 Artist's name
- 4 Name of the album

The following displays are available on the media menu:

- Media source selection list
- Current playback

▶ Select and confirm the media source.

▶ Select and confirm the required playback.

ⓘ This is how to select a station when TV is the media source.

Dialling a telephone number using the on-board computer

⚠ WARNING Risk of distraction from information systems and communications equipment

If you operate information and communication equipment integrated in the vehicle when driving, you will be distracted from the traffic situation. This could also cause you to lose control of the vehicle.

- ▶ Only operate this equipment when the traffic situation permits.
- ▶ If you cannot be sure of this, stop the vehicle whilst paying attention to road and traffic conditions and operate the equipment with the vehicle stationary.

When using the phone, you must observe the legal requirements for the country in which you are currently driving.

Requirements:

- The mobile phone is connected to the multimedia system.

On-board computer:

☞ Telephone

Select one of the following options:

- Previous calls
- Phone book
- Call status

Vehicles with MBUX multimedia system: The most recent telephone calls (dialled numbers, accepted and missed calls) are displayed on the [Telephone](#) menu.

- ▶ Select and confirm a telephone number.
If only one telephone number has been saved for the entry: The telephone number is dialled.
- ▶ **If several telephone numbers have been saved for the entry:** Select and confirm a telephone number.
The telephone number is dialled.

Instead of the selected telephone numbers, the following displays may appear:

- **Please wait:** The application is currently starting. If no Bluetooth® connection to the mobile phone is established, the menu for authorising and connecting a mobile phone will be displayed in the multimedia system (→ page 247).
- **Updating data:** The call list is being updated.
- **Importing contacts:** The mobile phone's contacts, or a memory medium's contacts are being imported.

Accepting/rejecting a call

When you are called, the [Incoming call](#) message appears on the display.

- ▶ Press  to accept the call or  to reject it.

You can also accept or reject the call using the  or  buttons on the steering wheel.

Calling up settings on the on-board computer

On-board computer:

☞ Settings

The following entries can be set on the Settings menu:

- [Lights](#)
 - Setting [Instrument lighting](#)
- [Vehicle](#)
 - Switching [Regensensor](#) (Rain sensor) on and off
- Setting [Heating](#)
- [Anzeige und Bedienung](#)
 - Switching permanent [Anzeige AdBlue Level](#) on and off

- ▶ Select an entry and confirm the selection.
- ▶ Make the necessary changes.

Notes on operating safety

- ▲ WARNING** Risk of distraction from information systems and communications equipment

If you operate information and communication equipment integrated in the vehicle when driving, you will be distracted from the traffic situation. This could also cause you to lose control of the vehicle.

- ▶ Only operate this equipment when the traffic situation permits.
- ▶ If you cannot be sure of this, stop the vehicle whilst paying attention to road and traffic conditions and operate the equipment with the vehicle stationary.

- ▲ WARNING** Risk of distraction from operating mobile communication equipment while the vehicle is in motion

If you operate mobile communication equipment when driving, you will be distracted from the traffic situation. This could also cause you to lose control of the vehicle.

- ▶ Only operate this equipment when the vehicle is stationary.

For your own safety, always observe the following points when operating mobile communications equipment and especially your voice control system:

- Observe the legal requirements for the country in which you are driving.
- While driving, only operate mobile communications equipment and your voice control system when the traffic conditions permit it. You may otherwise be distracted from the traffic conditions and cause an accident, injuring yourself and others.
- If you use the voice control system in an emergency your voice can change and your telephone call, e.g. an emergency call, can thereby be unnecessarily delayed.
- Familiarise yourself with the voice control system functions before starting the journey.

Operation

Multifunction steering wheel operation overview

LINGUATRONIC is operational approximately thirty seconds after the ignition is switched on.

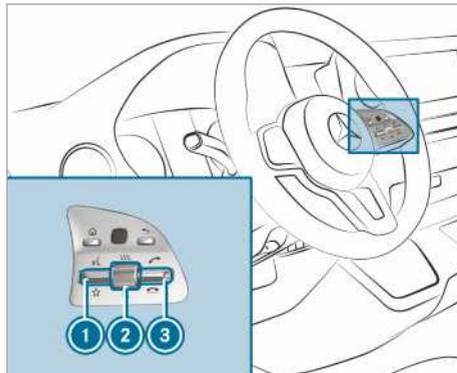

- ① Press the rocker switch up:  starts the dialogue
- ② Press the control knob:  switches the sound off or on (ends the dialogue)
Turn the control knob up/down: increases/decreases the volume
- ③ Press the rocker switch down:  rejects/ends a call (ends the dialogue)

Conducting a dialogue with LINGUATRONIC

For the dialogue with LINGUATRONIC, you can use complete sentences of colloquial language as voice commands, such as, for example, "Please show me the list of the last calls" or "How warm is it outside?". It is also not necessary to first change to the relevant application such as "Telephone" or "Vehicle function".

- ▶ **To activate or continue dialogue by using a keyword:** say "Hello Mercedes" to activate LINGUATRONIC. Voice activation must be switched on in the multimedia system (→ page 189). For this, it is not necessary to press up the  rocker switch on the multifunction steering wheel.
Voice activation can also be directly combined with a voice command, e.g. "Hello Mercedes, how fast can I drive?".

or

- ▶ Press the  rocker switch up on the multi-function steering wheel.
You can say a voice command after an acoustic signal.
- ▶ **To correct an entry:** say the Correction voice command.
- ▶ **To select an entry from the selection list:** say the line number or the contents.
- ▶ **To browse the selection list:** say the Next or Back voice command.
- ▶ **To interrupt the dialogue:** say the Pause voice command.
The dialogue can be continued with the "Hello Mercedes" voice command or by pressing up the  rocker switch on the multifunction steering wheel.
- ▶ **To jump to the preceding dialogue:** say the Back voice command.
- ▶ **To jump back to the top dialogue level:** say the Home voice command.
- ▶ **To cancel the dialogue:** say the Close voice command or press the  or  button on the multifunction steering wheel.
- ▶ **To interrupt a voice output:** speak in the middle of a voice dialogue when the system is still answering.
The voice output is shortened and the conclusion is reached more quickly.
The corresponding option must be switched on in the multimedia system.

Operable functions

You can use the LINGUATRONIC voice control system to operate the following functions depending on the equipment:

- Telephone
- Text messages
- Navigation
- Address book
- Radio
- Media
- Vehicle functions
- Weather

Full functionality is only available with online voice control active (→ page 189).

Overview of types of voice commands

A distinction is made between the following voice commands:

- **Global voice commands** can be said at any time and regardless of the current application, e.g. the voice commands Navigate to, Call or Text message to.
- **Application-specific voice commands** are only available for the active application.

On the display next to the active application, examples of global voice commands and the corresponding application-specific voice commands are displayed on an autocue. The lists can be scrolled or operated by voice.

Number entry functions

- The numbers allowed are zero to nine.
- Telephone numbers can be entered as single digits.

Notes on the language setting

You can change the language of LINGUATRONIC via the system language settings. If the set system language is not supported by LINGUATRONIC, English will be selected.

LINGUATRONIC is available in the following languages:

- German
- English
- French
- Italian
- Dutch
- Polish
- Portuguese
- Russian
- Swedish
- Spanish
- Czech
- Turkish

Setting LINGUATRONIC (multimedia system)

Requirements:

For online voice control:

- Your vehicle is connected with your Mercedes PRO user account (→ page 199).

- There is an Internet connection (→ page 257).

For activation of contacts for online use:

- Online voice control is activated.

Multimedia system:

→  >> Settings >> System
>> LINGUATRONIC

Switching voice activation for LINGUATRONIC on/off

- ▶ Select **Voice activation "Hi Mercedes"**.
The function is activated or deactivated depending on the previous status.
When the function is active, the "Hi Mercedes" voice command can activate the dialogue.

Activating voice interruption

- ▶ Select **Voice barge-in**.
When the function is active, you can speak a command during voice output from the system.

Switching online voice control on/off

- ▶ Activate **Online recognition**.
-  Online voice control is activated at the factory.
- ▶ Select **Online recognition subscrip..**
You will be forwarded to the Mercedes PRO portal.
- ▶ Activate online voice control in the Mercedes PRO portal.

Activating contacts for online use

- ▶ Select **Contact upload for online recognition**.
When active the function allows contacts to be found more easily using voice input. Also, the quality of the pronunciation of contact names through the system is enhanced.

Using LINGUATRONIC effectively

Help functions

You receive information and help for:

- **For optimal operation:** say the Voice control tutorial voice command or call up the Digital Owner's Manual with I want to read the Owner's Manual for LINGUATRONIC, for example. The full extent of the Digital Own-

er's Manual is available when the vehicle is stationary.

- **Current application:** on the multifunction steering wheel, press the  rocker switch up and say the Help voice command. You will receive suggestions and information about operation of LINGUATRONIC for the current application.
- **Continued dialogue:** say the Help voice command during a voice dialogue. You receive aligned information for each step of the dialogue.
- **Specific function:** say the voice command for the desired function, e.g. with "Hi Mercedes, I would like to have help with my radio" or, after pressing the  rocker switch on the multifunction steering wheel up, say the Help for phone voice command, for example.

Notes on how to improve speech quality

If LINGUATRONIC does not understand you:

- activate online services. Recognition is improved.
- only operate LINGUATRONIC from the driver's seat.
- say the voice commands coherently and clearly, but do not exaggerate the words.
- avoid loud noises that cause interference while making a voice command entry, e.g. the entertainment in the rear-passenger compartment.
- say the voice tag with the same intonation when creating voice tags.
- **For telephone or address book entries:**
 - only create sensible address book entries in the system/mobile phone, e.g. enter surname and first name in the correct field.
 - do not use any abbreviations, unnecessary spaces or special characters.
- **For radio programme names:** say the Read out station list voice command and say the desired station name in the way the voice output reads aloud to you.

Information on the online services

The online services enable improved recognition and provide better and additional results based

on the external information, e.g. about weather or news. For this reason, we recommend you activate the online services.

To do this, you need a user account in the Mercedes PRO portal. If you do not yet have a user account, this must be created.

For more information consult a Mercedes-Benz service centre or visit the Mercedes PRO portal: <http://www.mercedes.pro>

Basic voice commands

Notes on the voice commands

Aside from the exact voice commands (see the "Voice command" column in the following tables)

Switch voice commands

Voice command	Colloquial example	Function
Switch to navigation	I would like to go to navigation	Switches to navigation
Switch to address book	I would like to switch to the address book	Switches to the address book
Switch to telephone	I would like to switch to the phone	Switches to the telephone
Switch to messages	Can you switch to messages please?	Switches to the messages application
Switch to radio	I would like to switch to the radio	Switches to radio
Switch to media	I would like to switch to the media application	Switches to media
Switch to comfort	I would like to go to the comfort application	Switches to the comfort settings
Switch to vehicle info	I would like to go to the vehicle application	Switches to vehicle information
Switch to settings	I would like to go to the settings menu	Switches to the menu with the setting options

Overview of navigation voice commands

Using navigation voice commands, you can enter POIs or conventional addresses as well as directly change important navigation settings.

to call up specific functions, in most cases LINGUATRONIC also understands a great many phrases from daily usage. Examples of these are listed in the "Colloquial examples" column. For some languages however these examples are only available to a limited extent.

Overview of switch voice commands

Switch voice commands can be used to open certain applications.

The following list offers just a small selection of the possible navigation commands. You will receive additional suggestions if you say Help for navigation.

Navigation voice commands

Voice command	Colloquial example	Function
Navigate to <address>	Navigate to address "100 King Street, Leeds"	Starts navigation to an address in the address book directly
Navigate to <name>	Drive/bring me to the private address of John Smith	Destination entry to a contact in the address book
Home	Home/To my own address	Starts navigation to home address
Navigate to <3 word address>	Drive to Takeover Dot Desk Dot Stumps	Starts navigation to a 3 word address, e.g. to the Mercedes-Benz Museum
Work	To my office/business/my job	Starts navigation to your workspace
Navigate to <POI>	Navigate me to McDonald's	Starts navigation to a POI directly
Enter POI	Bring me to a POI	Destination entry for a POI, e.g. the POI Brandenburg Gate.
I would like to navigate to <POI>	Find/search in the Internet/web for a <POI>	Conducts a POI search on the Internet only
Enter address in <country>	I would like to enter a new address in "France"	Enters a destination in the desired country
Enter country	Enter a new country	Enters a country
Enter city	I would like to enter a specific address	Enters a town
Search for district	I would like to look for a district	Enters a district
Navigate to an intersection	Drive me to a crossing	Navigate to an intersection
Enter the house number	Enter the number.	Enter the house number
Enter postcode	Start route guidance to a new postcode	Enters a postcode
Last destinations	Show the previous destinations	Selects a destination from the list of last entered destinations
Show alternative routes	Search for alternative routes	Switches route guidance to another route

Voice command	Colloquial example	Function
Start route guidance	I would like to start route guidance/Navigate there	Starts route guidance after entering a valid destination
Cancel route guidance	Can you quit route guidance?	Cancels route guidance
Driving recommendations on	Switch on driving recommendations	Switches on voice output for route guidance
Driving recommendations off	Mute the driving instructions	Switches off the voice output for route guidance
Display the traffic map	Switch to the map with the traffic disruptions	Switches on the traffic map
Hide traffic map	Switch off the traffic jam messages	Switches off the traffic map
POI symbols on	Show the symbols on the map	Switches on display of POI symbols on the map
Hide POI icons	Delete the map symbols	Switches off the POI symbols display on the map

Overview of telephone voice commands

You can use the telephone voice commands to make phone calls or search through the address book. The following list offers just a small selec-

tion of the possible telephone commands. You will receive additional suggestions if you say Help for phone.

Telephone voice commands

Voice command	Colloquial example	Function
Call <telephone number>	I would like you to dial <telephone number>	Makes a telephone call by entering the telephone number directly
Call <contact>	Call Jane Smith on her mobile	Makes a telephone call directly by entering a name from the address book
Latest calls	Show me the list of missed calls	The list of missed calls is shown
Call name	Dial a name	Makes a phone call. All address book names are available.
Search for contact	Find a specific name in the phone book	Searches for a contact. All address book names are available.
Previous calls	Show the latest call list	Displays all outgoing, incoming and missed telephone calls.
Latest calls	Show me the list of missed calls	The list of missed calls is shown

Voice command	Colloquial example	Function
Incoming calls	Show me the calls received	The list of incoming calls is shown
Outgoing calls	Show me the list of outgoing calls	The list of outgoing calls is shown
Redial	Redial/Call last phone number	Selects the last phone number dialled
Change phone	Could you please switch to the second phone?	Changes the primary telephones
Call MB emergency	Could you call the Mercedes-Benz emergency centre?	An emergency call is initiated
Call Mercedes PRO	Call Mercedes-Benz breakdown assistance	Mercedes PRO is called

Overview of the radio voice commands

Radio voice commands can also be used when the radio application runs in the background and another application is visible in the foreground.

The following list offers just a small selection of the possible radio voice commands. You will receive additional suggestions if you say Help for radio.

Radio voice commands

Voice command	Colloquial example	Function
Station <station name>	Change to station/channel Radio 1	To select the station/channel mentioned
Station <station name>	I would like to select station "Cool FM"	To select the radio station mentioned
Frequency <Frequency>	Go to station/radio frequency "eighty seven point five megahertz".	To enter a radio frequency, e.g. for the FM area
Next station	Find another station/Change station	To switch to the next station that can be received
Next radio station	Call up the next radio station	The next radio station in a list is called up
Previous station	Switch to the last station/to the previous programme	To switch to the previous station
Save station	Save station name	To save the current station in the favourites list
Store radio stations	Save the radio station, please	To save a station name for a radio station

Voice command	Colloquial example	Function
Show station list	Please show me the list of all stations	To show the list of stations that can be received
Read out station list	I'd like to listen to the station/programme list, please	To listen to the names of all receivable stations
Read out radio station list	Please read out the radio program	To have the list of available stations for the currently selected radio application read aloud
Traffic information on	Switch on traffic info	To switch on traffic announcements
Traffic information off	Switch off traffic information	To switch off traffic announcements
Radio info on	I want you to turn on additional radio station text	To switch on information about the current station
Radio info off	I want you to turn off additional radio station text	To switch off information about the current station

Overview of media player voice commands

Media player voice commands can also be used when the media player application runs in the background and another application is visible in

the foreground. The following list offers just a small selection of the possible media player voice commands. You will receive additional suggestions if you say Help for media or Help for player.

Media player voice commands

Voice command	Colloquial example	Function
Play <track/albums/artists/composers/music genres>	Play "Hey Jude"	The names of all available tracks, albums, artists, composers or genres are accepted during the search. In the case of a clear search result the track found is played back immediately.
Play track <track>	Play song "So What"	The available tracks are played back.
Play album <album>	Play album "A Night at the Opera"	The available albums are played back.
Play artist <artist>	I want to listen to the artist "Madonna"	The available artists are played back.
Play composer <composer>	I'd like to hear the composer "Ludwig van Beethoven"	The available composers are played back.
Play music genre <music genre>	I'd like to hear the music genre "Rock"	The available music genres are played back.

Voice command	Colloquial example	Function
Search for track <track>	I would like to search for the song "Sailing"	The names of all available tracks are accepted during the search. A selection list appears from which you can select the desired music. If you wish to play all the tracks in a selection list, say "Play all tracks".
Search for album <album>	Search for album "A Night at the Opera"	The names of all available albums are accepted during the search. A selection list appears from which you can select the desired music. If you wish to play all the tracks in a selection list, say "Play all tracks".
Search for artist <artist>	I would like to search for the artist "Elton John"	The names of all available artists are accepted during the search. A selection list appears from which you can select the desired music. If you wish to play all the tracks in a selection list, say "Play all tracks".
Search for composer <composer>	Search for composer "Beethoven"	The names of all available composers are accepted during the search. A selection list appears from which you can select the desired music. If you wish to play all the tracks in a selection list, say "Play all tracks".
Search for music genre <music genre>	Search for music genre "Pop"	The names of all available music genres are accepted during the search. A selection list appears from which you can select the desired music. If you wish to play all the tracks in a selection list, say "Play all tracks".
Next track	Start the next song/ video clip/film	Plays back the next track
Previous track	Play the last song/ composition/clip again	Plays back the previous track
Repeat this track	I'd like to listen to this track again	The current track is played back from the beginning
Play similar music	I'd like to hear similar music	Similar tracks are played back
Play random music	Play me a random track	Random tracks are played back
Random track list on	Turn random playback on	Switches on random mode
Random track list off	Switch off shuffle mode	Switches off random mode
What am I listening to?	Which music is currently playing?	The information about the track currently playing is read aloud

Overview of message voice commands

Text messages and e-mails can be created, edited and listened to using the message voice commands. The following list offers just a small selec-

tion of the possible message commands. You will receive additional suggestions if you say Help for messaging.

Message voice commands

Voice command	Colloquial example	Function
Text message to <Name>	Dictate a new text message to my brother Ben	To create a text message. All address book names are available.
Text message to <Name><Text>	Write a new message to Ms. Anne Harvey, business: "When is the next meeting?"	To write a text message to the person called up. The content of the text can be spoken immediately if online voice control has been activated.
Forward text message	Forward text	To forward selected or open text messages.
Read out new text messages	Read out all new texts	To read out new text messages.
Read out the last text message from <Name>	Read out last text message from "John, private"	The last text message from the person mentioned is read.
Reply	Send a message/e-mail/text message to the sender	To reply to a message
Reply in <language>	Reply to this message/text message in French	A reply is made to the message just read in another language.

Overview of vehicle voice commands

You can use the vehicle voice commands to directly call up the corresponding menus for the vehicle settings. The following list offers just a

small selection of the possible vehicle voice commands. You will receive additional suggestions if you say Help for vehicle settings or Help for vehicle functions.

Vehicle voice commands

Voice command	Colloquial example	Function
Current speed limit	Tell me the maximum permitted speed	To call up the current speed limit
Outside temperature	How cold is it outside?/How warm is it?	To call up the outside temperature
Average consumption	Read out the average fuel consumption	To call up average consumption
Vehicle data	Can you please display the vehicle data menu?	To call up vehicle data

Voice command	Colloquial example	Function
Engine data	Can I switch to the motor menu?	To call up engine data
Next service	Tell me my next service appointment	To call up the next service due date
Range	Tell me the current range	To call up range data
Consumption	Open the consumption menu	To call up consumption settings
Display and styles menu	Go to display and styles menu settings	To show display settings
Assistance menu	Show me the driver assistance settings	To display assistance settings
Light menu	Switch to the light settings	To display light settings

Information about Mercedes PRO

When you log in with a user account to the Mercedes PRO portal, then services and offers from Mercedes-Benz Vans will be available to you.

Availability is country-dependent. You can check the availability of Mercedes PRO in your country at the following page: <http://www.mercedes.pro>

For more information on Mercedes PRO contact a Mercedes-Benz service centre or visit the Mercedes PRO portal.

Information about Mercedes PRO connect

Mercedes PRO connect provides the following services:

- Accident and breakdown management (breakdown assistance call button or automatic accident or breakdown detection)

Use the breakdown assistance call button in the overhead control panel to make a call to the Mercedes-Benz Customer Centre (→ page 199).

You can also select a menu entry in the multimedia system (→ page 199).

- Mercedes-BenzEmergency call system

Use the  button (SOS button) in the overhead control panel to make a call to the Mercedes-Benz emergency call centre (→ page 199).

Mercedes PRO connect accident and breakdown management and the Mercedes-Benz emergency call centre are available for you around the clock for the use of the services.

Please note that Mercedes PRO connect is a Mercedes-Benz service. In emergencies, always call the national emergency services first using the standard national emergency service phone numbers. In emergencies, you can also use the Mercedes-Benzemergency call system (→ page 292).

The following conditions must be met to use Mercedes PRO connect services in the vehicle:

- you have access to a GSM network
- the contract partner's GSM network coverage is available in the respective region
- the ignition is switched on, so that vehicle data can be transferred automatically

Calling the Mercedes-Benz Customer Centre using the multimedia system

Multimedia system:



- ▶ Call **Mercedes PRO connect**.

After confirmation, the multimedia system sends the required vehicle data. The data transfer is shown in the media display.

Then, you can select a service and be connected to a specialist at the Mercedes-Benz Customer Centre.

Making a call via the overhead control panel

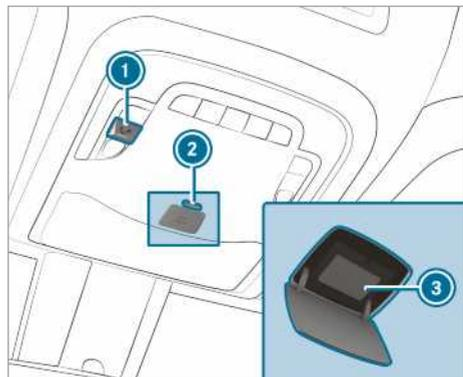

- ① Breakdown assistance call button
- ② Release catch for the cover on the  button (SOS button)
- ③  button (SOS button)

- ▶ **To make a breakdown assistance call:** press button ①.

- ▶ **To make an emergency call:** press the release catch for the cover on  button ② briefly to open.

- ▶ Press and hold  button ③ for at least one second.

An emergency call can still be triggered when a breakdown assistance call is active. This has priority over all other active calls.

Information on the breakdown assistance call via the overhead control panel

A call to the Mercedes-Benz Customer Centre using the breakdown assistance button has been initiated via the overhead control panel:

In the event of a breakdown, you will get support:

- A qualified Mercedes-Benz technician carries out repairs on site and/or the vehicle will be towed to the nearest Mercedes-Benz service centre.

You may be charged for these services.

You can find information on the following topics:

- activation of Mercedes PRO connect
- operating the vehicle
- nearest Mercedes-Benz service centre
- other products and services from Mercedes-Benz

Data is transmitted during the connection to the Mercedes-Benz Customer Centre (→ page 200).

Information on Mercedes PRO connect accident management

The Mercedes PRO connect accident management is an extension of the Mercedes-Benz emergency call system (→ page 292).

An emergency call is made to the Mercedes-Benz emergency call centre after an accident:

- a voice connection is made to a contact person at the Mercedes-Benz emergency call centre
- if necessary, the contact person at the Mercedes-Benz emergency call centre forwards the call to Mercedes PRO connect accident management
- if necessary, the vehicle will be towed to a Mercedes-Benz service centre

If the vehicle detects a minor accident, a message appears in the multimedia system.

The message is confirmed in the multimedia system:

- a voice connection is made to a contact person at Mercedes PRO connect accident management.
- if necessary, the vehicle will be towed to a Mercedes-Benz service centre

Giving consent to data transfer for Mercedes PRO connect

Requirements:

- There is an active breakdown assistance call (→ page 199).

If the accident and breakdown management services are not activated on Mercedes PRO, the [Do you want to transmit vehicle data and the vehicle's position to the Mercedes-Benz Customer Centre in order to improve the processing of your request?](#) message is shown.

Select Yes.

Relevant identification data is transmitted automatically.

More information on Mercedes PRO and the terms of use: <http://www.mercedes.pro>

Transmitted data during a breakdown assistance call

In certain countries you must confirm the data transfer.

When you make a breakdown assistance call via Mercedes PRO connect, data will be transferred.

Depending on which service is activated, the following data is transmitted when a call is made:

- vehicle identification number
- reason for the initiation of the call
- language set in the multimedia system
- confirmation of the data protection prompt
- current vehicle location
- mileage and maintenance data
- selected data about the status of the vehicle

The following data is transferred if no service is activated and the data protection prompt has been confirmed:

- vehicle identification number
- reason for the initiation of the call
- language set in the multimedia system
- confirmation of the data protection prompt

The following data is transmitted if the data protection prompt has been rejected:

- reason for initiating the call
- rejection of the data protection prompt

Overview and operation

Overview of the MBUX multimedia system

⚠ WARNING Risk of distraction from information systems and communications equipment

If you operate information and communication equipment integrated in the vehicle when driving, you will be distracted from the traffic situation. This could also cause you to lose control of the vehicle.

- ▶ Only operate this equipment when the traffic situation permits.
- ▶ If you cannot be sure of this, stop the vehicle whilst paying attention to road and traffic conditions and operate the equipment with the vehicle stationary.

You must observe the legal requirements for the country in which you are currently driving when operating the multimedia system. MBUX stands for Mercedes-Benz User Experience.

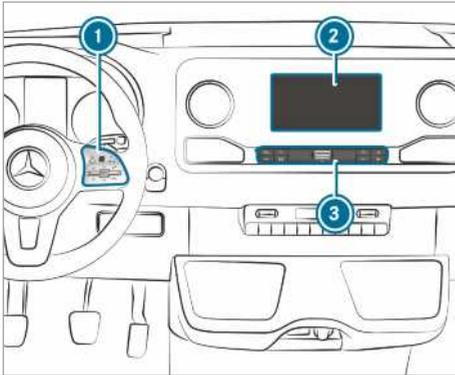

- ① Touch Control and multimedia system control panel
- ② Media display with touch functionality
Opens/closes the centre console stowage compartment above the display (→ page 78)
- ③ Operating strip, calls up applications

In the centre console stowage compartment you can find the following ports and interfaces:

- Two USB ports or one USB port

The USB port with the  symbol facilitates the connection of the mobile phone with the multimedia system using a suitable cable.

This will enable you to use the functions of the mobile phone via Apple CarPlay™ or Android Auto.

- Stowage space with charging interface and NFC interface (if available)

You can operate the multimedia system with the following central control elements:

- Touch Control ①
Operation takes place by cursor control.
- Media display (touchscreen) ②
- Buttons on operating strip ③

④ Alternatively you can conduct a dialogue with LINGUATRONIC (→ page 188).

Multiple applications are available for you. You can call these up using the home screen or using the buttons on operating strip ③.

You can conveniently call up and add favourites on the steering wheel using the  rocker switch. Quick-access in the home screen and in the applications serve to select functions more quickly.

If you use the learn function of the multimedia system, you will receive suggestions during operation of the most probable navigation destinations, radio stations and contacts. The configuration of the suggestions takes place in your profile. You can compile your profile from various vehicle settings and settings of the multimedia system.

The Notifications Centre collects incoming notifications, e.g. about an available software update. Depending on the type of notification it offers various actions. You can call up the Notifications Centre on the home screen and in the menus of the applications.

With the global search in the vehicle you can search on-board across many categories as well as online in the Internet. You can use the global search in the home screen and in the notifications.

Anti-theft protection

This device is equipped with technical provisions to protect it against theft. More detailed information about anti-theft protection can be obtained at a qualified specialist workshop.

Notes on the media display

Observe the notes on caring for the interior (→ page 289).

Automatic temperature-controlled switch-off

feature: if the temperature is too high, the brightness is initially reduced automatically. The media display may then switch off completely for a while.

- ⓘ If you are wearing polarised sunglasses, it may be difficult to read the media display.

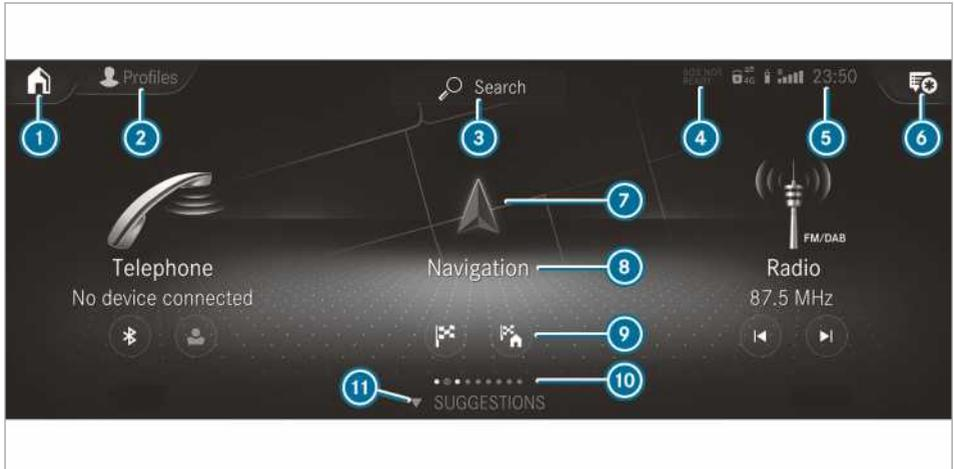
Home screen overview

- ① On the home screen: displays the first three applications
In other displays: calls up the home screen
- ② Calls up the profile
- ③ Calls up the global search
- ④ SOS NOT READY display only when the Mercedes-Benz emergency call system is not available
- ⑤ Displays, for example network display, battery status of the mobile phone connected, signal strength of the mobile phone network, time
- ⑥ Calls up the Notifications Centre
The star indicates new notifications.
- ⑦ Calls up an application using the symbol
- ⑧ Name of the application, beneath the current selection or information
- ⑨ Quick-access (in the example: calls up destination entry and enters the destination address for home)
- ⑩ Number of applications and currently selected display area
- ⑪ Calls up **SUGGESTIONS** and **FAVOURITES**

Touch Control

Operating Touch Control (multimedia system)

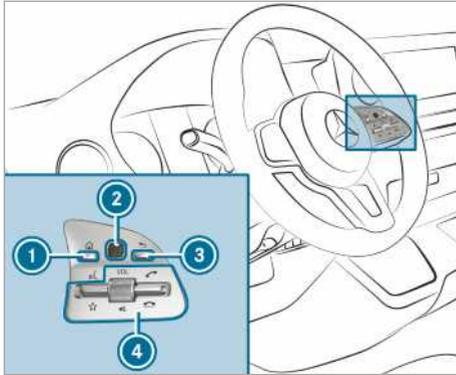

- ① button
Calls up the home screen
- ② Touch Control
- ③ Back button
Returns to the previous display
- ④ Control panel for multimedia system
Press the rocker switch down: shows favourites
Turn the control knob: sets the volume
Press the control knob: switches sound off
Press the rocker switch up: makes or accepts a call
Press the rocker switch down: ends or declines a call

▶ **To call up the home screen:** press button ①.

or

- ▶ Press and hold button ③.
- ▶ **To open a menu or list:** press Touch Control ②.
- ▶ **To close a menu or list:** press button ③.
- ▶ **To select a menu item:** swipe up, down, left or right on Touch Control ②.
- ▶ Press Touch Control ②.
- ▶ **To move the digital map:** swipe in any direction.

Setting the sensitivity for the Touch Control

Multimedia system:

- ▶ ▶ Settings ▶ System
- ▶ ▶ Controls ▶ Touch Control sensitivity

▶ Select **Fast**, **Medium** or **Slow**.

Switching acoustic operating feedback for the Touch Control on/off

Multimedia system:

- ▶ ▶ Settings ▶ System
- ▶ ▶ Controls

The function is supported by the selection in a list.

- ▶ Select **Acoustic operating feedback**.
- ▶ Set **Normal**, **Loud** or **Off**.
If the function is activated you will hear a clicking sound when scrolling in a list. When the beginning or end of the list is reached you will hear another clicking sound.

Touchscreen

Operating the touchscreen

Tapping

- ▶ **To select a menu item or entry:** tap on a symbol or an entry.
- ▶ **To increase the map scale:** tap twice quickly with one finger.
- ▶ **To reduce the map scale:** tap with two fingers.
- ▶ **To enter characters with the keyboard:** tap on a button.

Single-finger swipe

- ▶ **To navigate in menus:** swipe up, down, left or right.
- ▶ **To move the digital map:** swipe in any direction.
- ▶ **To use handwriting to enter characters:** write the character with one finger on the touchscreen.

Two-finger swipe

- ▶ **To zoom in and out of the map:** move two fingers together or apart.
- ▶ **To enlarge or reduce the size of a section of a website:** move two fingers together or apart.
- ▶ **To turn the map:** turn anti-clockwise or clockwise using two fingers.

Touching, holding and moving

- ▶ **To move the map:** touch the touchscreen and move your finger in any direction.
- ▶ **To set the volume on a scale:** touch the touchscreen and move the finger to the left or right.

Touching and holding

- ▶ **To save the destination in the map:** touch the touchscreen and hold until a message is shown.
- ▶ **To call up a global menu in the applications:** touch the touchscreen and hold until the **OPTIONS** menu appears.

Setting acoustic operation feedback for the touchscreen

Multimedia system:

-  ▶ Settings ▶ System
- ▶▶ Controls ▶▶ Touch Control sensitivity

The function is supported by the selection in a list.

- ▶ Select **Acoustic operating feedback**.
- ▶ Set **Normal**, **Loud** or **Off**.
If the function is activated you will hear a clicking sound when scrolling in a list. When the beginning or end of the list is reached you will hear another clicking sound.

Applications

Calling up applications

Using buttons on the operating strip

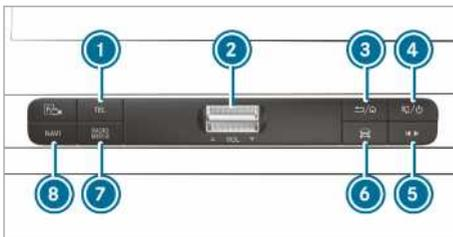

- ① **TEL** button
Calls up the telephone
- ② Volume rocker switch
Adjusts the volume (→ page 205)
- ③  button
Press briefly: returns to the previous display
Press and hold: calls up the home screen

- ④  button
Press briefly: switches sound off
Press and hold: activates/deactivates the multimedia system
- ⑤ Quick-access button for media
Calls up the control menu of the last active media source
- ⑥ Vehicle button
Sets vehicle functions
- ⑦ **RADIO MEDIA** button
Pressing repeatedly calls up the desired audio source
- ⑧ **NAVI** button
Calls up navigation

▶ To access stations and music tracks quickly: press button ⑤.

The control menu appears for the audio source that was last selected.

▶ Swipe to the left or right.

Radio: the previous or next station is set.

Media source: the previous or the next music track is selected.

▶ To hide the control menu: press button ⑤.

Using the home screen

The home screen is shown in the media display when you start the vehicle.

- ▶ Select the application by swiping and tapping.
or

- ▶ **In any display:** press the  button on the Touch Control.

or

- ▶ Tap on the  symbol on the touchscreen. The applications are displayed.
- ▶ Select the application by swiping and tapping.

Changing the arrangement of applications on the home screen

- ▶ Call up the home screen
- ▶ Touch and hold an application on the touchscreen until symbols appear.
- ▶ Tap on  or  and move the application in the menu.
- ▶ Tap on .

Switching the sound on/off

On the multifunction steering wheel

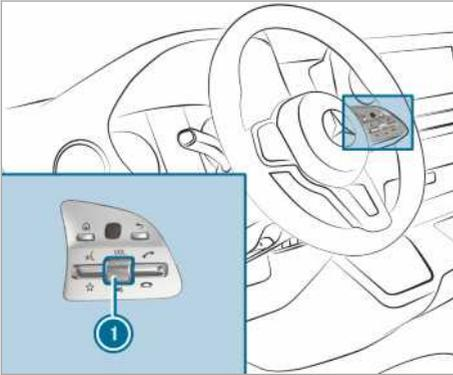

- ▶ **To mute:** press volume control ①. The  symbol appears in the status line of the multimedia system display. You will also hear traffic announcements and navigation announcements even when the sound is muted.
- ▶ **To switch on:** turn volume control ① or change the media source.

On the multimedia system



- ▶ **To switch off:** briefly press button ①. The  symbol appears in the status line of the multimedia system display. You will also hear traffic announcements and navigation announcements even when the sound is muted.
- ▶ **To switch on:** briefly press button ① or change the media source.

Adjusting the volume

On the multifunction steering wheel

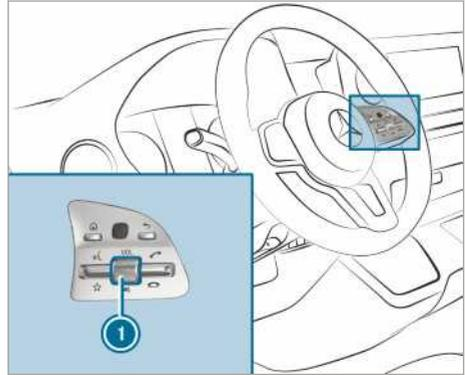

- ▶ Turn volume control ①. The volume of the current radio or media source is set. The volume of other audio sources can be adjusted separately.

Adjust the volume in the following situations:

- during a traffic announcement
- during a navigation announcement

The volume of the current media source changes in accordance with the volume of the navigation announcement.

- during a telephone call

On the multimedia system

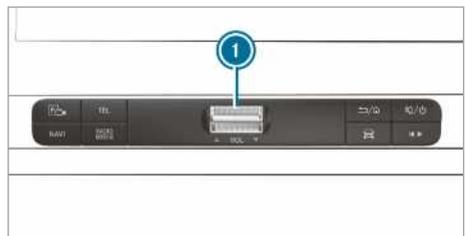

- ▶ **To raise/reduce the volume in steps:** briefly press rocker switch ① up or down.
- ▶ **To raise/reduce the volume continuously:** press rocker switch ① up or down until the desired volume is set.

Profile

Overview of profiles

Using the multimedia system up to seven profiles can be created in the vehicle.

Profiles store your personal vehicle settings and settings for the multimedia system.

If the vehicle is used by several drivers, the driver can select their profile before the journey, without changing the settings of other drivers.

You can select the profile:

- when entering (→ page 206)
- on the home screen (→ page 202)

The profile settings are activated as soon as a profile is selected.

Profile content

The following settings can be saved in your profile, for example:

- Radio (including station list)
- Last destinations
- Favourites and suggestions

Creating a new profile

Multimedia system:

   Profiles

- ▶ Select  **Create profile**.
- ▶ Select an avatar.
- ▶ Enter the name and confirm with .
- ▶ Select **Continue** .

▶ **To save the current settings in a profile:** select **Current settings**.

▶ Select **Save**.

or

▶ **To adopt factory settings:** select **Save save directly**.

 Further information on setting a user profile (→ page 206).

▶ Activate Bluetooth® and select **Connect phone**, to connect a mobile phone with the user profile (→ page 247).

You can also set up a user profile without registering a mobile phone.

▶ Select **Finished**.
The user profile is saved.

Selecting profile options

Multimedia system:

   Profiles

- ▶ Select  for a profile.
- ▶ **To edit a profile:** select **Edit profile**.
- ▶ Select an avatar.

▶ Change the name, if necessary.

▶ Select **Save**.

▶ **To configure suggestions:** select **Suggestions settings** (→ page 207).

▶ **To reset favourites:** select **Reset favourites to factory settings**.

▶ Select **Yes**.

▶ **To reset a profile:** select **Reset profile to factory settings**.

▶ Select **Yes**.

▶ **To delete a profile:** select **Delete profile**.

▶ Select **Yes**.

 The guest profile cannot be deleted.

Selecting a profile

Multimedia system:

   Profiles

▶ Select a profile.

▶ Press the  button to confirm the message.

The profile is loaded and activated.

 Alternatively, the profile can already be selected when the vehicle is entered (→ page 206).

Showing the profile selection when entering

Requirements:

- At least one profile has been created.

Multimedia system:

   Profiles

▶ Select **General settings**.

▶ Activate **Show profile selection when entering**.

When the vehicle is started, the media display shows the active profile.

Suggestions

Suggestions overview

The vehicle can learn the habits of the driver. Based on the habits that have been learned by the system, the most likely navigation destinations, music tracks, radio stations or contacts are offered under **SUGGESTIONS**.

Suggestions are shown when the following requirements are fulfilled:

- A profile has been created (→ page 206).

No suggestions are available in the **Guest** profile.

- A profile has been selected.
- You have accepted data recording.
- From the beginning of usage, the multimedia system must analyse the user habits. When sufficient data is collected then the suggestions are available.

If the requirements mentioned are not fulfilled, a preview with a description of the function appears in the **SUGGESTIONS** menu.

You can configure the data recording (→ page 207) or delete unsuitable suggestions (→ page 207) in order to improve suggestions.

Calling up suggestions

Requirements:

- An individual user profile has been created and is selected (→ page 206).
- i** The guest profile is active when the multimedia system is first started.
- ▶ Tap on  in the media display. The home screen is shown.
 - ▶ Swipe up until the **SUGGESTIONS** menu is shown.
 - ▶ Select a navigation destination, a music track, a radio station or a contact.
- i** If route guidance is already active, you can start a suggestion as a new route guidance or set an intermediate destination for the existing route.

Configuring suggestions

Multimedia system:

- ▶    Profiles
- ▶ Select  for a profile.
- ▶ Select **Suggestions settings**.
- ▶ **To switch suggestions display on/off:** switch **Allow destination suggestions**, **Allow music suggestions** and **Allow contact suggestions** on or off.
If an option is switched on, suggestions for navigation destinations, music tracks, radio stations or contacts are shown.
If the option is switched off, no suggestions are shown.
- ▶ **To deactivate the learn function for one day:** activate **Deact. learn. for 24h**.
For 24 hours no new actions will be trained and no data recorded for the active profile.

Suggestions will continue to be shown. The remaining time is shown next to **Deact. learn. for 24h**.

Before the time runs out, a message is shown that the multimedia system will continue the learn function shortly.

Example: if the option is switched on and a route to a new destination has been calculated, this destination would not be taken into account for the learn function.

- ▶ **To reset the suggestion history:** select **Reset suggestion history**.

i This process cannot be reversed.

- ▶ Select **Yes**.

Renaming suggestions

Only navigation destinations can be renamed.

- ▶ Tap on the  symbol in the media display. The home screen is shown.
- ▶ Swipe up until the **SUGGESTIONS** menu is shown.
- ▶ Highlight a navigation destination and press until the **OPTIONS** menu is shown.
- ▶ Select **Rename**.
- ▶ Enter the name.
- ▶ **To confirm the entry:** select **Yes**.

Deleting a suggestion

- ▶ Tap on  in the media display. The home screen is shown.
- ▶ Swipe up until the **SUGGESTIONS** menu is shown.
- ▶ Highlight a suggestion and press until the **OPTIONS** menu is shown.
- ▶ Select **Delete**.

Deleting suggestions in the applications

You can delete suggestions in the previous destinations, in the radio station list and in the contacts.

- ▶ Select  for a suggestion.
- ▶ Select **Do not suggest**.
- ▶ **To delete the suggestion from the current list:** select **Not now**.
The suggestion will be shown again at a later time in the list.
- ▶ **To delete a suggestion permanently:** select **Never**.

- ▶ Select **Yes**.
The suggestion will not be shown again in future. All suggestions are reset.
- ▶ **To cancel the function:** select **Cancel**.

Favourites

Overview of favourites

Favourites offer you quick access to frequently used applications. It is possible to create 20 favourites in total.

You can select favourites from categories or you add favourites directly from an application.

Calling up favourites

In the media display

- ▶ Tap on .
The home screen is shown.
- ▶ Swipe up until **FAVOURITES** is shown.

Using the steering wheel

- ▶ Press the  rocker switch on the steering wheel down.

Adding favourites

Selecting favourites from categories

- ▶ Tap on  in the media display.
The home screen is shown.
- ▶ Swipe up until **FAVOURITES** is shown.
- ▶ Select  **Create favourite**.
The categories are displayed.
- ▶ Select the category.
The favourites are displayed.
- ▶ Select a favourite.
The favourite is stored at the next available position.
- ▶ **All positions in the favourites are taken:** confirm the message shown with **OK**.
A list shows all the favourites.
- ▶ Select a favourite which should be overwritten.

Adding a favourite from an application

Examples of adding from an application are:

- Saving a contact.
- Storing a radio station.
- Adding a media source.
- Saving a navigation destination.

- ▶ **To save a contact as a global favourite:** select a contact (→ page 251).
The details are displayed.
- ▶ Press on a phone number until the **OPTIONS** menu is shown.
- ▶ Select **Save as favourite**.
The contact is added as a favourite.
- ▶ **To store a radio station as a global favourite:** set a radio station (→ page 268).
- ▶ Press on the radio station until the **OPTIONS** menu is shown.
- ▶ Select **Save as favourite**.
The radio station is added as a favourite.

Renaming favourites

- ▶ Tap on  in the media display.
The home screen is shown.
- ▶ Swipe up until **FAVOURITES** is shown.
- ▶ Press on a favourite until the **OPTIONS** menu is shown.
- ▶ Select **Rename**.
- ▶ Enter the name.
- ▶ Select **OK**.

Moving favourites

Moving favourites in the favourites menu

- ▶ Tap on  in the media display.
The home screen is shown.
- ▶ Swipe up until **FAVOURITES** is shown.
- ▶ Press on a favourite until the **OPTIONS** menu is shown.
- ▶ Select **Move**.
- ▶ Move the favourite to the new position.
- ▶ Tap on .

Moving the favourites menu in the personalisation

- ▶ Tap on  in the media display.
The home screen is shown.
- ▶ Swipe up until **Set new order** is shown.
- ▶ Select **Set new order**.
- ▶ Move **Favourites** to the new position.
- ▶ Tap on .
- ▶ **To close the menu:** select **Close**.

Deleting favourites

- ▶ Tap on  in the media display.
The home screen is shown.

- ▶ Swipe up until **FAVOURITES** is shown.
- ▶ Press on a favourite until the **OPTIONS** menu is shown.
- ▶ Select **Delete**.
- ▶ Select **Yes**.

Notifications Centre

Overview of the Notifications Centre

The following communications are collected in the Notifications Centre:

- Communications which are generated by the vehicle or from multimedia system.
- Communications which are received through the use of services.

The following notification types are available for you:

- Navigable destinations and routes
- Messages (text messages)
- System information, e.g. software update available
- Other notifications, e.g. from additional online services that can be subscribed to

The Notifications Centre  can be found on the home screen, in menus and at the top right of the navigation map (→ page 202).

A star in the  symbol informs you of new notifications.

Notifications are normally briefly shown as they are received. This occurs for nearly every application that you are currently using. If you take no action, these are stored for future access in the Notifications Centre.

The notifications are sorted chronologically. The most recent notifications are at the top.

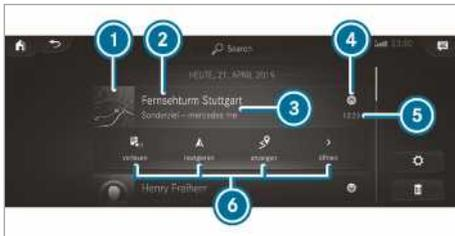

A notification shows the following information:

- Symbol or image **1** for the application

- Title **2**, which contains the name, a telephone number or a navigation destination, for example
- The service and additional information **3**
- A time stamp **5**
- If several actions are available, symbol **4** to open or close the notification.

Depending on the type of notification, up to four different actions **6** are available.

Examples of actions include:

- Read aloud
- Placing a call
- Replying
- Calling up a web page
- Navigating

Some notifications, e.g. a navigation destination, are stored longer. Therefore, it is not necessary to carry out available actions directly on the receipt of the notifications. A route guidance can be started at a later time.

 You can start a global search in the Notifications Centre (→ page 210).

Calling up notifications

Multimedia system:



Opening the Notifications Centre

▶ **On the touchscreen:** tap on the  symbol for the Notifications Centre.

or

▶ **On the Touch Control:** mark the  symbol for the Notifications Centre by swiping.

▶ Press on the control element.

Selecting a notification

▶ Swipe up or down.

▶ Tap or press on the control element.

Calling up old notifications

If notifications have not been called up after four hours, these are stored in the archive.

▶ Swipe upwards and select **Archive**.

▶ Select the notification.

Selecting actions for a notification

The following options are available:

- Select the action directly in an application after a notification is received and shown.

- Select the action later after calling up in the Notifications Centre.

- ▶ **An action is available:** select the action.
- ▶ **Several actions are available:** if the notification is not open, select the  symbol.
- ▶ Select the action.
The notification is still available.

Editing notifications

Multimedia system:

- ▶  Call up the Notifications Centre (→ page 209).
- ▶ **To make settings:** select .
- ▶ **i** If no settings can be made, a message appears.
- ▶ Activate or deactivate the setting.
- ▶ **To delete:** select the recycle bin.
- ▶ Select **Delete** or **Delete all**.
Delete deletes a single notification.
Delete all deletes all notifications currently shown.
- ▶ With **Finished** you will exit delete mode.

Global search

Global search overview

You can use the global search in the home screen and in the notifications.

The global search provides search results for the following categories and their sub-categories:

- Navigation
- Media
- Telephone, social media
- User interface and Digital Owner's Manual
- Internet

This enables you to search for towns, roads and tourist attractions with the navigation system, for example.

- ▶ **i** You can also search for 3 word addresses (→ page 225).
When you enter a 3 word address in the global search, separate each of the words with a space or a full stop.

During the entry process the most likely suggestions are shown beneath the search field. When you enter "S", "Stuttgart", "Steak" and "Sandra" are shown, for example. If you select "Stuttgart",

you receive the suggestions "Starbucks", "Steak" and "City railway", for example.

The search results in the list are shown, sorted according to category. Next to the category is the number of results. You will be shown the best results from each category. Additional results can be found after selecting the respective category.

If you confirm an entry with **OK**, all categories and the number of results will be shown in a summary. After selecting a category you can select the search results within the category. When you select a search result the detailed view opens. In the detailed view you can choose whether and which actions you want to carry out with the respective search result. For example, you can start route guidance or place a call to somebody. The actions are named correspondingly.

The search can be carried out with the following input methods:

- Entering characters using the on-screen keyboard
- Entering characters with handwriting recognition
- Dictation function

Using the global search

Multimedia system:

- ▶  Select  **Search**.
- ▶ or
- ▶ Call up the notifications (→ page 209).
- ▶ Select **Search**.
- ▶ Enter the search term into the search field. Use the character input function. During the entry process the three most likely suggestions are offered beneath the search field.
In the list on the right, the top two search results are shown for each category.
- ▶ **i** Alternatively, you can use the  dictation function for the search.
- ▶ **To accept a suggestion:** select the suggestion.
The three most likely suggestions are offered.
- ▶ Continue the search or accept a suggestion.
- ▶ **To accept the second search result:** select the search result.
An action starts or a list is shown.
- ▶ Select a search result or an action in the list.

- ▶ **To show all categories:** select **OK**.
- ▶ **To show search results for a category:** select a category.
- ▶ **To show details:** select a search result.
- ▶ **To start an action:** select an action.
After selection of an action, a track is played back or the route to a destination is calculated, for example.

Entering characters

Using the character input function

⚠ WARNING Risk of distraction from information systems and communications equipment

If you operate information and communication equipment integrated in the vehicle when driving, you will be distracted from the traffic situation. This could also cause you to lose control of the vehicle.

- ▶ Only operate this equipment when the traffic situation permits.
- ▶ If you cannot be sure of this, stop the vehicle whilst paying attention to road and traffic conditions and operate the equipment with the vehicle stationary.

You must observe the legal requirements for the country in which you are currently driving when operating the multimedia system.

Character entry can be carried out with these control elements:

- Touch Control
- Touchscreen (media display)

Character entry takes place by cursor control when using the Touch Control.

Character input can be started with a control element and resumed with another.

- ▶ When the keyboard is shown, enter the characters on the control element by swiping and pressing or by tapping (touchscreen).
or

- ▶ Write the character on the touchscreen.

Examples of character entry:

- Renaming a favourite
- Entering a destination address in the navigation system
- Entering a web address

Entering characters on the touchscreen

Requirements:

- An online connection is required for some functions.

Using the keyboard



- | | | |
|---|---|---|
| <ul style="list-style-type: none"> ① Input line ② Shows suggestions during entry (if available) ③ Deletes an entry ④ Deletes
Pressing or pressing briefly deletes the last character entered
Pressing and holding deletes the entry ⑤ Accepts an entry | <ul style="list-style-type: none"> ⑥ Switches to handwriting input ⑦ Enters a space ⑧ Changes the keyboard language ⑨ Switches to special characters ⑩ Switches to digits and additional special characters (if available for the current character set) | <ul style="list-style-type: none"> ABC switches to letters (level 2) ⑪ Pressing or pressing briefly switches between upper-case and lower-case letters (if available for the current character set)
Pressing and holding switches to upper-case letters permanently |
|---|---|---|

If available, the  symbol allows you to change to voice input.

- ▶ Call up the character entry to rename a favourite, for example (→ page 208). The keyboard is shown.
- ▶ Press briefly on a character key. The character is entered in input line ①. Suggestions are shown in ②.
- ▶ **To select a suggestion:** select one of the entries.

- ▶ If available, display additional suggestions with  or .
 - ▶ Resume character input.
 - ▶ **To enter an alternative character:** press and hold a character.
 - ▶ Select the character.
 - ▶ **To end character input:** press the  button.
- ① The available editing functions depend on the editing task, the language set and the character level.

Using handwriting input

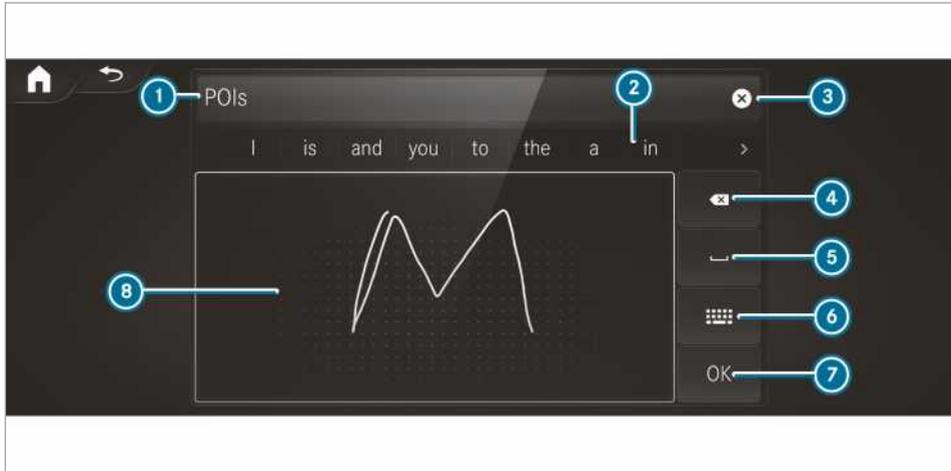

- | | |
|--|--|
| ① Input line | Pressing and holding deletes the entry |
| ② Shows suggestions during entry | ⑤ Enters a space |
| ③ Deletes an entry | ⑥ Switches to input using the keyboard |
| ④ Deletes
Pressing or pressing briefly deletes the last character entered | ⑦ Accepts an entry |
| | ⑧ Writes characters on the drawing surface |

If available, the  symbol allows you to change to voice input.

- ▶ Call up the character entry to rename a favourite, for example (→ page 208).
- ▶ When the keyboard is displayed, select .
- ▶ Write the character with one finger on the touchscreen.
The character is entered in input line ①. Suggestions are shown in ②.
- ▶ **To select a suggestion:** select one of the entries.
- ▶ If available, display additional suggestions with  or .
- ▶ Resume character input. The letters can be written next to each other or above each other.
- ▶ **To end character input:** press the  button.

Setting the keyboard for character entry

Multimedia system:

- ▶ Settings ▶ System ▶ Controls
- ▶ Keyboards and handwriting

- ▶ Confirm **Select keyboards**.
Select the keyboard language in the list.

System settings

Display

Configuring display settings

Multimedia system:

- ▶ Settings ▶ System
- ▶ Styles & display

Styles

- ▶ Select **Classic**, **Sport** or **Progressive**.

Display brightness

- ▶ Select **Display brightness**.
- ▶ Select a brightness value.

Switching the display off/on

- ▶ **Off:** select [Display off](#).
- ▶ **On:** press a button, , for example.

Display design

- ▶ Select [Day/night design](#).
- ▶ Select [Automatic](#), [Day design](#) or [Night design](#).

Time and date

Setting the time and date automatically

Multimedia system:

→  ▶▶ [System](#) ▶▶ [Time and date](#)

- ▶ Deactivate [Manual time adjustment](#).
The time and date are set automatically for the selected time zone and summer time option.

- ⓘ The correct time is required for the following functions:
 - Route guidance with time-dependent traffic guidance.
 - Calculation of expected time of arrival.

Setting the time zone

Requirements:

- **For setting the time zone manually:** the [Automatic time zone](#) function is activated.

Multimedia system:

→  ▶▶ [Settings](#) ▶▶ [System](#)
▶▶ [Time and date](#)

Setting the time zone manually

- ▶ Select [Time zone](#):

The list of countries is displayed.

- ⓘ If there are several time zones available in a country, these will be shown after the country is selected.
- ▶ Select a country and, if required, a time zone.
The time zone set is displayed after [Time zone](#):

Setting the time zone automatically

- ▶ Activate [Automatic time zone](#).

Setting the time and date format

Multimedia system:

→  ▶▶ [Settings](#) ▶▶ [System](#)
▶▶ [Time and date](#) ▶▶ [Set format](#)

- ▶ Set the date and time format •.

Setting the time and date manually

Requirements:

- The [Manual time adjustment](#) function is switched on.
- **For setting the date manually:** no GPS is installed in the vehicle.

Multimedia system:

→  ▶▶ [Settings](#) ▶▶ [System](#)
▶▶ [Time and date](#)

Setting the time (without time zone)

- ▶ Select [Set time](#).
- ▶ Set a time.

Setting the time (with time zone)

- ▶ Select [Set time](#).

If a time zone is set the time is set automatically using the time zone. The time can be adjusted by a maximum of plus or minus 60 minutes.

- ▶ Adjust the time using the slide control.

Setting the date

- ▶ Select [Set date](#).
- ▶ Set a date.

- ⓘ In vehicles with GPS, a date cannot be set even with active manual time adjustments. The date is then set automatically through the selected time zone.

Bluetooth®

Information about Bluetooth®

Bluetooth® technology is a standard for short-range wireless data transfer up to approximately 10 m.

You can use Bluetooth® to connect your mobile phone to the multimedia system and use the following functions, for example:

- Hands-free system with access to the following options:
 - Call lists (→ page 252)
- Internet connection
- Listening to music via Bluetooth® audio
- Transferring business cards (vCards) into the vehicle

Bluetooth® is a registered trademark of Bluetooth Special Interest Group (SIG) Inc.

-  Internet connection via Bluetooth® is not available in all countries.

Activating/deactivating Bluetooth®

Multimedia system:

  **Settings**  **System**
 **Wi-Fi & Bluetooth**

-  **To switch on Bluetooth®:** select **Connect via Bluetooth**.
-  Activate **Bluetooth**.
-  **To switch off Bluetooth®:** select **Settings**.
-  Deactivate **Bluetooth**.

Wi-Fi

Wi-Fi connection overview

You can use Wi-Fi to establish a connection with a Wi-Fi network and to access the Internet or other network devices.

The following connection options are available:

- **Wi-Fi connection**
The Wi-Fi connection is established to a Wi-Fi-capable device, e.g. to the customer's mobile phone or tablet PC.
- **Multimedia system as a Wi-Fi hotspot**
Using this function, a tablet PC or notebook can be connected, for example.

To establish a connection, you can use the following methods:

- **WPS PIN**
The connection to a secure Wi-Fi network is made via a PIN.
- **WPS PBC**
The connection to a secure Wi-Fi network is made by pressing a button (push button).
- **Security key**
The connection to a secure Wi-Fi network is made via a security key.

Setting up Wi-Fi

Requirements:

- The device to be connected supports one of the three means of connection described.

Multimedia system:

  **Settings**  **System (System)**
 **Wi-Fi & Bluetooth**

Switching on Wi-Fi

-  Select **Wi-Fi**.
The Wi-Fi is switched on and you can connect the multimedia system with external hot-spots.

Switching off Wi-Fi

-  Select **Settings**.
-  Deactivate **Wi-Fi**.
If **Wi-Fi** is deactivated, communication via Wi-Fi to all devices is interrupted. This also means that a connection to the communication module cannot be established. Then some functions such as dynamic route guidance with Live Traffic Information are not available.

Connecting the multimedia system with a new device via Wi-Fi

This function is available if a communication module is not installed.

The type of connection established must be selected on the multimedia system and on the device to be connected.

-  The connection procedure may differ depending on the device. Follow the instructions that are shown in the display. Further information (see the manufacturer's operating instructions).

-  Select **Internet settings**.
-  Select **Connect via Wi-Fi**.
-  Select **Add hotspot**.

Connecting using a security key

-  Select the options  of the desired Wi-Fi network.
-  Select **Connect using security key**.
-  Have the security key displayed on the device to be connected (see the manufacturer's operating instructions).
-  Enter this security key on the multimedia system.
-  Confirm the entry with **ok**.

-  All devices support a security key as a means of connection.

Connecting using a WPS PIN

- ▶ Select the options  of the desired Wi-Fi network.
- ▶ Select [Connect using WPS PIN input](#).
The multimedia system generates an eight-digit PIN.
- ▶ Enter this PIN on the device to be connected.
- ▶ Confirm the entry.

Connecting using a button

- ▶ Select the options  of the desired Wi-Fi network.
- ▶ Select [Connect via WPS PBC](#).
- ▶ Select "Connect via WPS PBC" in the options on the device to be connected (see the manufacturer's operating instructions).
- ▶ Press the WPS button on the device to be connected.
- ▶ Select [Continue](#) in the multimedia system.

Activating automatic connection

- ▶ Select [Connect via Wi-Fi](#).
- ▶ Select the options  of the desired Wi-Fi network.
- ▶ Activate [Permanent Internet connection](#).

Connecting with a known Wi-Fi

- ▶ Select [Connect via Wi-Fi](#).
- ▶ Select a Wi-Fi network.
The connection is established again.

Setting up a Wi-Fi hotspot

Multimedia system:

- ↳  ▶ [Settings](#) ▶ [System](#) (System)
- ▶ [Wi-Fi & Bluetooth](#)

Configuring the multimedia system as a Wi-Fi hotspot

The type of connection established depends on the device to be connected. The function must be supported by the multimedia system and by the device to be connected. The type of connection established must be selected on the multimedia system and on the device to be connected.

- ▶ Select [Vehicle hotspot](#).
- ▶ Select [Connect device to vehicle hotspot](#).

Connecting using WPS PIN generation

- ▶ Select [Connect using WPS PIN generation](#).
- ▶ Enter the PIN shown in the media display on the device to be connected and confirm.

Connecting using WPS PIN entry

- ▶ Select [Connect using WPS PIN input](#).
- ▶ Enter the PIN that is shown on the external device's display on the multimedia system.

Connecting using a button

- ▶ Select [Connect via WPS PBC](#).
- ▶ Press the push button on the device to be connected (see the manufacturer's operating instructions).
- ▶ Select [Continue](#).

Connecting using a security key

- ▶ Select [Connect device to vehicle hotspot](#).
A security key is displayed.
- ▶ Select the vehicle from the device to be connected. It will be shown with the [DIRECT-MB Hotspot 12345](#) network name.
- ▶ Enter the security key which is shown in the media display on the device to be connected.
- ▶ Confirm the entry.

Connecting using NFC

- ▶ Select [Connect via NFC](#).
- ▶ Activate NFC on the mobile device (see the manufacturer's operating instructions).
- ▶ Bring the mobile device into the NFC area of the vehicle (→ page 248).
- ▶ Select [Finished](#).
The mobile device is now connected to the multimedia system hotspot via NFC.

Generating a new security key:

- ▶ Select [Vehicle hotspot](#).
- ▶ Select [Generate security key](#).
A connection will be established with the newly created security key.
- ▶ **To save a security key:** select [Save](#).
When a new security key is saved, all existing Wi-Fi connections are then disconnected. If the Wi-Fi connections are being re-established, the new security key must be entered.

System language

Notes on the system language

This function allows you to determine the language for the menu displays and the navigation messages. The selected language affects the characters available for entry. The navigation announcements are not available in all languages.

If a language is not available, the navigation announcements will be in English.

Setting the system language

Multimedia system:

→  >> Settings >> System
>> Language

▶ Set the language.

-  If you are using Arabic map data, the text information can also be shown in Arabic on the navigation map. To do so, select العربية as the language from the language list. Navigation announcements are then also made in Arabic.

Setting the distance unit

Multimedia system:

→  >> System >> Units

▶ Select km or mi.

▶ In the multifunction display of the instrument display, switch the [Additional speedometer](#) display on.

Data import and data export

Data import/export function

The following functions are possible:

- transfer data from one system or vehicle to another system or vehicle.
- make a backup copy of your personal data and load it again.
- protect your personal data against unwanted export with PIN protection.

-  Please note that the NTFS file system is not supported. The FAT32 file system is recommended.

Importing/exporting data

 **NOTE** Loss of data due to premature removal

▶ Do not remove the data storage medium when data is being exported.

Mercedes-Benz is not liable for any loss of data.

Requirements:

- The vehicle is stationary.
- The ignition is switched on

- A USB device is connected .

Multimedia system:

→  >> System >> System backup

▶ Select [Import data](#) or [Export data](#).

Importing

▶ Select a data storage medium.

A prompt appears asking whether you really wish to overwrite the current data. If data originates from another vehicle, this is recognised during data reading.

The multimedia system is restarted once the data has been imported.

-  Current vehicle settings can be edited after the import.

Exporting

If PIN protection is activated, your PIN is requested.

▶ Enter the four-digit PIN.

▶ Select a data storage medium.

The data is exported. The data export may take several minutes.

-  After successful export, the data is saved in the "MyMercedesBackup" directory which can be found on the storage medium.

Activating/deactivating PIN protection

Multimedia system:

→  >> Settings >> System
>> PIN protection

Setting the PIN

▶ Select [Set PIN](#).

▶ Enter a four-digit PIN.

▶ Enter the four-digit PIN again.

If both PINs match, PIN protection is active.

Changing the PIN

▶ Select [Change settings](#).

▶ Enter the current PIN.

▶ Select [Change PIN](#).

▶ Set a new PIN.

Activating PIN protection for data export

▶ Select [Change settings](#).

▶ Confirm with the PIN.

▶ Select [Protect data export](#).

▶ Activate or deactivate the function.

Unblocking the PIN

- ▶ Consult a Mercedes-Benz service centre and have the PIN protection reset.

Software update

Information on software updates

A software update consists of three steps:

- Downloading or copying of the data required for installation
- Installation of the update
- Activation of the update by restarting the system

The multimedia system provides a message when an update is available.

Depending on the source, you can perform various updates:

Software update

Source of the update	Update type
Internet	Navigation map, system updates, Digital Owner's Manual
External storage medium, e.g. USB flash drive	Navigation maps

Advantages of updating software

Software updates ensure your vehicle's technology is always up-to-date.

In order to constantly improve the quality of our services you will receive future updates for your multimedia system, the Mercedes PRO connect services and your vehicle's communication module. These will conveniently be sent to you via the mobile phone connection in your vehicle and, in many cases, installed automatically. You can monitor the status of your updates at any time via the Mercedes PRO portal and find information about potential innovations.

Your advantages at a glance:

- conveniently receive software updates via the mobile phone network
- the long-term quality and availability of Mercedes PRO connect is guaranteed
- keep your multimedia system and communication module up-to-date

Further information about software updates can be found at <http://www.mercedes.pro>

Performing a software update

Requirements:

- **For online updates:** an Internet connection is established (→ page 257).
- **For automatic online updates:** your vehicle has a permanently installed communication module.

Multimedia system:

↳ Settings ▶ System ▶ Software update

Automatically

- ▶ Activate [Automatic online updates](#).
The updates will be downloaded and installed automatically.
The current status of the updates is displayed.

Manually

- ▶ Deactivate [Automatic online updates](#).
- ▶ Select an update from the list and start the update.

Activating the software update

- ▶ Restart the system.
The modifications from the software update will be active.

Important system updates

Important system updates may be necessary for the security of your multimedia system's data. Please install these updates, or else the security of your multimedia system cannot be ensured.

- ⓘ If automatic software updates are activated, the system updates will be downloaded automatically (→ page 218).

As soon as an update is available for download, a corresponding message appears on the media display.

You have the following selection options:

- **Download**
The update will be downloaded in the background.
- **Details**
Information about the pending system update is displayed.
- **Later**
The update can be downloaded manually at a later time (→ page 218).

Deep system updates

Deep system updates access vehicle or system settings and can therefore only be carried out when the vehicle is stationary and the ignition is switched off.

If the download of a deep system update is completed and the update is ready for installation, you will be informed of this after the next ignition cycle, for example.

- ❗ Park the vehicle safely in a suitable location before starting the installation.

Requirements for the installation:

- The ignition is switched off.
- Notes and warnings have been read and accepted.
- The parking brake is applied.

If all requirements are met, the update will be installed. The multimedia system cannot be operated while the update is being installed and vehicle functions are restricted.

If errors should occur during the installation, the multimedia system automatically attempts to restore the previous version. If restoration of the previous version is not possible, a symbol appears on the media display. Please consult a qualified specialist workshop to resolve the problem.

Reset function (resetting)

Multimedia system:

→  » Settings » System » Reset

Resetting via the multimedia system

Personal data is deleted, for example:

- Station presets
- Connected mobile phones
- Individual user profiles

- ❗ The guest profile is reset when the settings are restored to the factory settings.

- ▶ Select **Yes**.

If PIN protection is activated, a prompt appears asking if you also wish to restore this to the factory settings during a reset.

- ▶ Select **Yes**.
- ▶ Enter the current PIN.
- ▶ The PIN is reset.

Or

- ▶ Select **No**.
The current PIN stays the same after resetting.

- ❗ If you have forgotten your PIN, a Mercedes-Benz service centre can deactivate the PIN protection for you.

A prompt appears again asking whether you really wish to reset.

- ▶ Select **Yes**.
The multimedia system is reset to the factory settings.

Resetting using a button

- ▶ Press both the  and  buttons at the same time until the multimedia system restarts (at least 15 seconds).
The multimedia system is restarted. No data is deleted during this process.

Vehicle information

Displaying vehicle data

Multimedia system:

→  » Info

- ▶ Select **Vehicle**.
The vehicle data is displayed.

Displaying engine data

Multimedia system:

→  » Info

- ▶ Select **Engine**.
The engine data is displayed.
- ❗ The values for engine output and engine torque may deviate from the nominal values.
Items that can influence this are, for example:
 - Engine speed
 - Sea level
 - Fuel grade
 - Outside temperature

Calling up the fuel consumption indicator

Multimedia system:

→  » Info

- ▶ Select **Consumption**.
A display with current and average consumption figures is displayed.

Navigation

Switching navigation on

Multimedia system:

→  >> [Navigation](#) (Navigation)

Alternatively: press the **NAVI** button.
The map appears. The current vehicle position is shown. The navigation menu is shown.

The navigation menu is hidden if route guidance is active.

The navigation menu is hidden if route guidance is active.

▶ **To show:** tap on the touchscreen.
or

▶ Press the Touch Control.
▶ **To hide:** the navigation menu is hidden automatically.

Showing/hiding the navigation menu

→  >> [Navigation](#) (Navigation)

If route guidance is not active the map appears.
The navigation menu is shown.

Navigation overview

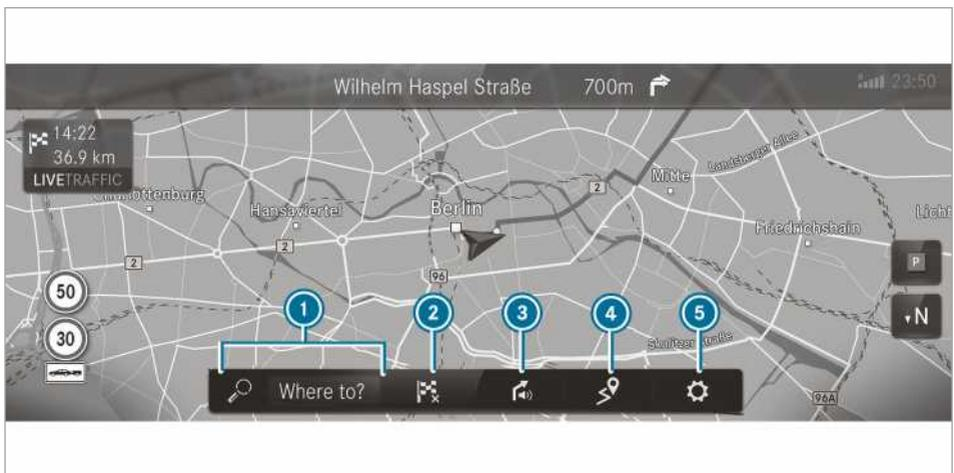

Example: digital map with navigation menu

- ① To enter a POI or address and additional destination entry options
- ② To interrupt route guidance (if route guidance is active)
- ③ To repeat a navigation announcement and switch navigation announcements on/off
- ④ To call up the **ON ROUTE** menu

- To show **Route overview**
- To select **Alternative routes**
- **Report traffic incident (Car-to-X)**
- To call up the **TRAFFIC** menu
- ◊ To show **Traffic announcements**
- ◊ To show **Area messages**
- ◊ To show **Live Traffic Subscription Info**

- To show **Route list**
- To call up the **POSITION** menu
- ◊ **Store position**
- ◊ To show **Compass**
- ◊ To show **Qibla** (available in selected countries)
- ⑤ **Quick-access and settings**
- To show **Traffic**
- To show **Parking**
- To show **Motorway information**

- Via [Advanced](#) options to use [View, Announcements](#) and [Route](#)

- ① Some options are not available in all countries.
- ① You can enter 3 word addresses in the online search (→ page 225). This option is not available in all countries.

Destination entry

Notes on destination entry

⚠ WARNING Risk of distraction from operating integrated communication equipment while the vehicle is in motion

If you operate communication equipment integrated in the vehicle when driving, you will be distracted from the traffic situation. This could also cause you to lose control of the vehicle.

- ▶ Only operate this equipment when the traffic situation permits.
- ▶ If you cannot be sure of this, stop the vehicle whilst paying attention to road and traffic conditions and operate the equipment with the vehicle stationary.

You must observe the legal requirements for the country in which you are currently driving when operating the multimedia system.

Entering a POI or address

⚠ WARNING Risk of distraction from information systems and communications equipment

If you operate information and communication equipment integrated in the vehicle when

driving, you will be distracted from the traffic situation. This could also cause you to lose control of the vehicle.

- ▶ Only operate this equipment when the traffic situation permits.
- ▶ If you cannot be sure of this, stop the vehicle whilst paying attention to road and traffic conditions and operate the equipment with the vehicle stationary.

You must observe the legal requirements for the country in which you are currently driving when operating the multimedia system.

Requirements:

- **For the online search:** Mercedes PRO connect is available.
- You have a user account for the Mercedes PRO portal.
- The service is available.
- The service has been activated at a Mercedes-Benz service centre.

Further information can be found at: <http://www.mercedes.pro>

Multimedia system:

- ▶  ▶ [Navigation](#) (Navigation)
- ▶  [Where to?](#)

Using the on-board search function



Destination entry uses the on-board search of the database stored in the multimedia system.

The country in which the vehicle is located is set **1**.

▶ Enter the POI or the address using the keyboard (in the image) or using handwriting recognition **6** in **2**. The entries can be made in any order.

During destination entry, suggestions are made under **2** by the multimedia system. Destination selection takes place in list **3** or with **OK**.

If the multimedia system is equipped with a small display, calling up list **3** is carried out using a list symbol at the top right.

The following entries can be made, for example:

- Town, street, house number
- Street, town
- Postcode
- POI name
- POI category, e.g. **Tankstelle** (Filling station)
- Town, POI name
- Telephone number, if this is available for the POI
- Contact name

Example of quick address entry:

- If you are searching for Königsstraße in Stuttgart, for example, you can enter STUT and KÖN.
- If you are searching for a POI in the United Kingdom, for example, you can enter THE SHARD.

If you would like to try out both examples, you may also need to change the country.

▶ As an alternative, voice input **8** can also be used.

▶ **To switch to handwriting recognition:** select **6**.

▶ Write the character on the touchscreen. The letters can be written next to each other or above each other (→ page 211).

▶ **To return to entry using the keyboard:** select **11**.

▶ **To delete an entry:** select **4**. The characters are deleted individually.

or

▶ If characters have been entered in **2**, select **10** next to the input line. The complete entry is deleted.

▶ **To switch to upper-case or lower-case letters:** select **11**.

▶ **To switch to digits, special characters and symbols:** select **10**. 123 changes to ABC.

Display **11** changes to #+=.

▶ Select ⑪ and switch to additional special characters.

▶ **To enter a space:** select ⑦.

▶ **To set the language:** select ⑨.

▶ Select the language.

① This function is useful for countries in which several character sets are supported. An example is Russia, which uses Cyrillic and Latin characters.

▶ **To change the country:** select country indicator ①.

▶ Enter the country indicator, e.g. F for France. The list is filtered.

▶ Select the country on list ③.
The destination can be entered.

▶ **To accept a destination:** select the destination in list ⑤.

▶ If the destination is ambiguous, select the destination in the list.
The destination address is shown. The route can be calculated.

Using online search

① Requirements: the media display shows an Internet connection with a double-arrow symbol in the status line.

Online search is not available in all countries.

Destination entry uses online map services. If the on-board search finds no suitable destinations or if you change countries, the online search is available.

For the destination you can enter an address, a POI or a three-word address.

▶ Select country indicator ①.

▶ Select the provider for the online service from the countries list.

or

▶ If the on-board search delivers no search results, select [Online search](#).

▶ Enter the destination in the input line. The entry order is not relevant, e.g. street and town. Use the functions described for the on-board search.
The search results are displayed.

▶ Select the destination in the list.
The detailed view for the route is displayed.

Selecting previous destinations

Requirements:

- Previous destinations are stored.
- **For destination suggestions:** you have created a profile (→ page 206).
- The [Allow destination suggestions](#) option is switched on (→ page 207).
- The multimedia system has already gathered sufficient data in order to show destination suggestions.

Multimedia system:

→  ▶ [Navigation](#) ▶  [Where to?](#)
▶ [PREV. DESTINATIONS](#)

The following destinations can be selected:

- Destination suggestions (→ page 236)
- Destinations
- Routes

▶ Select the destination or route.
The destination address is shown. The route can be calculated.

① If you save a previous destination or a suggestion as a favourite (→ page 236), you can select these from the favourites (→ page 225).

Selecting a POI

Requirements:

- **For use of personal POIs:** a USB device is connected with the multimedia system.
- Personal POIs with the GPS Exchange format (.gpx) have been saved in the "PersonalPOI" folder on the USB device.

Multimedia system:

→  ▶ [Navigation](#) ▶  [Where to?](#)
▶ [POIS](#)

Searching using categories (no route guidance)

▶ Select the category.

or

▶ Select [All categories](#).

▶ Select the category and the sub-category (if available).

The search takes place in the vicinity of the vehicle's current position. The search result are sorted by distance in ascending order.

The POIs show the following information:

- direction of the linear distance to the POI (arrow)
- name of POI
- linear distance to the POI

▶ **To filter according to categories or in search results:** enter a search entry in the  Search text field.

▶ Select a POI from the list.

The destination address is shown. The route can be calculated.

Searching using categories (route guidance active)

▶ Select the category, for example [Tankstelle](#) (Filling station).

or

▶ Select [All categories](#).

▶ Select the category and the sub-category (if available).

▶ **To filter according to categories or in search results:** enter a search entry in the  Search text field.

▶ Select the search positions [In the vicinity](#), [Near destination](#) or [Along the route](#).

▶ If there are intermediate destinations for the route and [Near destination](#) has been selected, select the POI in the route overview.

▶ Select a POI from the list.

The destination address is shown. The route can be calculated.

Searching for personal POIs

▶ Select [Personal POIs](#).

▶ Select a category.

▶ If route guidance is active, select a search position [In the vicinity](#), [Near destination](#) or [Along the route](#).

▶ Select a personal POI.

The destination address is shown. The route can be calculated.

or

▶ Enter a search entry into the search field and filter the list.

▶ Select a personal POI.

Editing personal POI categories

▶ Select a personal POI category from the list



A menu opens.

▶ **To change a name:** select [Change name](#).

▶ Enter the name.

▶ Select .

▶ **To change a symbol:** select [Change icon](#).

▶ Select a symbol.

▶ **To delete a personal POI category:** select [Delete](#).

▶ Select [Yes](#).

Configuring categories for quick-access

You can configure the categories for quick-access.

If you calculate the route, for example, the first three of these categories can be selected as symbols.

▶ Select [All categories](#).

▶ Select the category and the sub-category (if available).

▶ Select ☆ or ★.

☆ adds the category.

★ removes the category.

▶ If all available quick-access positions are full, select the category to be replaced.

Selecting a contact for destination entry

Requirements:

- A mobile phone is connected to the multimedia system (→ page 247).

Multimedia system:

  ▶ [Navigation](#) ▶  [Where to?](#)

▶ [CONTACTS](#)

Using the contact list

▶ Select a contact.

The contact details are displayed.

▶ Select the address.

Using search entry

▶ Enter a name or telephone number, for example, into the search field.

▶ Select .

▶ Select the contact.

▶ Select the address.

The destination address is shown. The route can be calculated.

ⓘ Route guidance to a contact address is reliable in the following cases:

- The contact address is complete.

- The contact data matches the map data in the digital map.

Entering geo-coordinates

Multimedia system:

  **Navigation**  **Where to?**
» GEO-COORDINATES

- ▶ Select **Latitude** or **Longitude**.
- ▶ Select geo-coordinates as latitude and longitude coordinates in degrees, minutes and seconds. To do this swipe up or down respectively.
The map shows the position.
- ▶ Confirm the entry with **OK**.
- ▶ **To set the destination:** select  or .
- ▶ Calculate the route (→ page 226).

Entering the destination as a 3 word address

Requirements:

- Searching for a destination using 3 word addresses is possible in the online search (→ page 221).
 - The media display shows an Internet connection with a double-arrow symbol in the status line.
-  Searching for a destination using 3 word addresses is not possible in all countries.

Multimedia system:

  **Navigation**  **Where to?**

- ▶ Select the country indicator.
 - ▶ Select the provider for the online service from the countries list.
- or
- ▶ If the on-board search delivers no search results, select **Online search**.
 - ▶ Enter the destination address as a 3 word address. Separate each of the words with a full stop.
The search results are displayed.
 - ▶ Select the destination in the list.
The destination address is shown. The route can be calculated.

-  3 word addresses from what3words are an alternative addressing system for multilingual georeferencing of global locations with a resolution of three metres. Using this grid, locations on the Earth's surface are included which do not have a building address such as street and house number, for example.

The Brandenburg Gate in Berlin has the following language dependent 3 word address, for example:

- German: **tapfer.gebäude.verliehen**
- English: **that.lands.winning**
- French: **posteaux.bobineur.ombrant**

3 word addresses are unique, easy to remember and suffice for most routine applications.

The conversion of addresses into and back from 3 word addresses can be carried out here:

- At the website <http://what3words.com>
- In the what3words apps

Selecting a destination on the map

Multimedia system:

  **Navigation**

- ▶ Move the map (→ page 240).
- ▶ When the crosshair marks the destination, press and hold on the control element.
The destination address is shown.
If several destinations are located around the crosshair, a list shows the available roads and POIs.
- ▶ Select the destination in the list.
The destination address is shown. The route can be calculated.

Showing POIs in the vicinity of the map

If several destinations are located around the crosshair, the function is available.

- ▶ Select .
 - ▶ Select **POIs in the vicinity**.
The map appears.
 - ▶ Swipe left or right on the control element.
The previous or next POI is highlighted on the map. The name or the address is shown.
 - ▶ Select the POI symbol.
- or
- ▶ **To filter the display according to the POI category:** scroll on the control element.
 - ▶ Select the POI category.

Selecting a destination from favourites

Requirements:

- Destinations are saved as favourites.
Save a previous destination or a destination suggestion as a favourite (→ page 236).

Multimedia system:

→  » **Navigation**

»  **Where to?** » **FAVOURITES**

▶ Select a favourite.

The destination address is shown. The route can be calculated.

The following options are available in the favourites menu:

- Saving addresses for home and work
- Creating favourites
- Deleting favourites

▶ **If no address has been saved for home and work:** select **Home** or **Work**.

▶ Confirm the prompt with **Yes**.

▶ Enter the favourite as a POI or address (→ page 221).

▶ **To save a favourite:** select **Add favourites**.

▶ Enter the favourite as a POI or address (→ page 221).

or

▶ If all the positions in the favourites are full, first select a favourite which is to be overwritten (→ page 208).

▶ Follow the instructions provided.

▶ **To delete a favourite:** select  for a destination.

▶ Select **Delete**.

or

▶ Press on a favourite until the **OPTIONS** menu is shown.

▶ Select **Delete**.

Route

Calculating a route

Requirements:

- The destination has been entered.
- The destination address is shown.

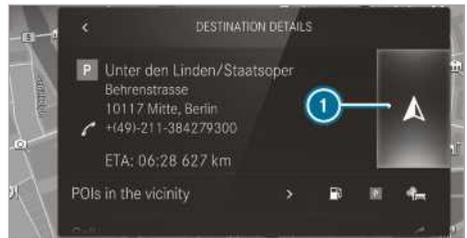

①  No route yet

 A route has been mapped

▶ Select .

The route to the destination is calculated. The map shows the route. Route guidance then begins.

or

▶ Select .

If a route is already mapped, a prompt is shown.

▶ Select **Set as intermediate dest..**

The selected destination address is set as the next intermediate destination. Route guidance begins.

If there are already four intermediate destinations, the multimedia system asks whether intermediate destination 4 should be deleted. Confirm the prompt with **Yes**.

or

▶ Select **Start new route guidance**.

The selected destination address is set as a new destination. The previous destination and the intermediate destinations are deleted. Route guidance to the new destination begins.

Searching for POIs in the vicinity

① The POI symbols to the right of **POIs in the vicinity** show the first three categories for quick-access. You can configure these categories (→ page 223).

▶ Select a POI symbol.

The search results are displayed.

▶ Select a POI.

The destination address is shown. The route can be calculated.

or

▶ Select **POIs in the vicinity** .

▶ Search using categories, enter a search entry or search for a personal POI (→ page 223).

- ▶ Select a POI.
The destination address is shown. The route can be calculated.

Other menu functions

- ▶ **To save the destination:** select  .
 - ▶ Select an option.
The following options are available:
 - Save in "Previous destinations"
 - Save as favourite
 - Save as "Home"
 - Save as "Work"
 - ▶ **To call the destination:** if a telephone number is available, select **Call**.
 - ▶ **To share the destination using NFC or QR code:** select **Share via NFC or QR code**.
 - ▶ Hold the NFC area of the mobile phone (see manufacturer's operating instructions) on the mat or place the mobile phone on it (→ page 248).
- or
- ▶ Hold the mobile phone near to the multimedia system and scan the QR code.
 - ▶ **To call up an Internet address:** if a web address is available, select **www**.
 - ▶ **To show on the map:** select **Display on the map**.

Selecting a route type

Multimedia system:

-   ▶▶ **Navigation** ▶▶ 
- ▶▶ **Advanced** ▶▶ **Route**

- ▶ Select the route type.
If no route has been created, the next route is calculated on the basis of the new route type.
If a route has already been created, the route is calculated on the basis of the new route type.

The following route types are available:

- **Fast**
A route with a quick journey time is calculated.
- **Short**
A route with a short driving distance is calculated.
- **Eco**

An economical route is calculated. The journey time may be somewhat longer than for quicker routes.

- **Trailer**

The option is available if a trailer has been coupled with the vehicle.

A prompt is shown in the multimedia system. Confirm the prompt.

The route is optimised for trailer operation.

For these route types you can select the following dynamic route guidance options:

- ▶ Select **Dynamic route guidance** .
- ▶ Select **Automatic**, **After asking** or **Off**.

Explanation of the options:

- **Automatic**

The route is calculated with the currently set route type.

Traffic messages via Live Traffic Information or FM RDS-TMC are taken into account (→ page 236).

Live Traffic Information and FM RDS-TMC are not available in all countries.

- **After asking**

A prompt appears when a new route is detected with a shorter journey time based on traffic reports. You can continue to use the current route or use the dynamic route instead (→ page 239).

- **Off**

No traffic reports are taken into account for the route.

Calculating alternative routes

- ▶ Activate **Suggest alternative route**.
The display button is activated. Alternative routes are calculated for every route.
- ▶ Select an alternative route (→ page 230).

Selecting route options

Multimedia system:

-   ▶▶ **Navigation** ▶▶ 
- ▶▶ **Advanced** ▶▶ **Route**

Avoiding areas

- ▶ Select **Avoid options**.
- ▶ Select **Avoid areas** (→ page 242).

Avoiding or using motorways, ferries, tunnels, motorail trains, unpaved roads

- ▶ Select [Avoid options](#).
- ▶ Activate or deactivate the avoid option.
To avoid: the display button is activated. The route avoids motorways, for example.
To use: the display button is off. The route takes motorways into consideration, for example.

The selected route options cannot always be implemented. Therefore, a route may include a ferry, for instance, even though the [Avoid ferries](#) avoid option is enabled. A message appears and you will hear a corresponding message.

Avoiding or using toll roads

- ▶ Select [Avoid options](#).
- ▶ Select [Toll roads](#).
- ▶ Activate or deactivate [Avoid all](#).

or

- ▶ Switch the [Payment by cash or card](#) and [Electronic billing](#) options on or off.
To avoid: the display button is activated. The route avoids toll roads with the selected method of payment.
To use: the display button is off. The route takes into account roads that require the payment of a usage fee (toll) corresponding with the payment type selected.

Avoiding or using roads requiring a special toll sticker

- ▶ Select [Avoid options](#).
- ▶ Select [Vignette roads](#).
- ▶ Activate or deactivate [All](#).

or

- ▶ Activate or deactivate the countries.
To avoid: the display button is activated. The route avoids roads requiring a special toll sticker in the selected countries.
To use: the display button is off. The route takes into account roads in the selected country which require you to pay a time-based fee (vignette). A vignette allows for the use of a route network for a limited time period.

 These route options are not available in every country.

Selecting notifications

Requirements:

- **For an audible indication when approaching a personal POI:** the USB device contains personal POIs.
- The USB device is connected with the multimedia system.
- The category in which the personal POI belongs is activated.

Multimedia system:



- ▶ Activate [Announce street names](#).
The display button is activated. The name of the street into which you should turn is announced in the guidance instructions.
This option is not available in all countries and languages.

Selecting messages for TRAFFIC

- ▶ Activate a message.
The display button is activated.
The following options are available:

- [Traffic incidents](#)
Traffic incidents are announced, e.g. road-works and road blocks.
This function is not available in all countries and languages.
- [Announce warnings](#)
Warning messages are announced, e.g. before tailbacks that pose a risk (if available).
This function is not available in all countries and languages.

Audible indication when approaching a personal POI

- ▶ Select [Personal POIs](#).
- ▶ Activate a category.
The display button is activated. When approaching a personal POI in this category an audible indication will be issued.

Showing destination information for the route

Requirements:

- A destination is entered.

Multimedia system:



▶ Select **Route overview**.

When route guidance is active, the destination and intermediate destinations are shown, if these have been entered and not yet been passed.

The route can include up to four intermediate destinations.

▶ Select a destination or an intermediate destination.

The following information is displayed:

- Remaining driving distance
- Time of arrival
- Remaining journey time
- Name, destination address
- Phone number (if available)
- Web address (if available)

Planning routes

Multimedia system:



▶ Select **Set intermediate destination**.

▶ Enter the intermediate destination as a POI or address, for example (→ page 221).

▶ Select the intermediate destination. After selection of an intermediate destination, the route overview is shown again.

▶ Calculate the route with intermediate destinations (→ page 229)

- i** If there are already four intermediate destinations, delete an intermediate destination (→ page 229).

Editing a route with intermediate destinations

Requirements:

- A destination is entered.
- For the moving function there must also be at least one intermediate destination.

Multimedia system:



▶ **To change the sequence of destinations:**

select for an intermediate destination or destination.

A menu opens.

▶ Select **Move**.

is highlighted.

▶ Move the intermediate destination or the destination with or to the desired position.

▶ Tap on .

▶ **To delete a destination:** select for an intermediate destination or destination.

▶ Select **Delete**.

The destination is deleted.

Calculating a route with intermediate destinations

Requirements:

- The destination and at least one intermediate destination have been entered.

Multimedia system:



▶ Select **Start route guidance**.

or

▶ If the route has been edited, select **To Navigation** .

▶ Confirm the prompt with **Yes**.

The route is calculated. Route guidance begins.

Displaying the route list

Multimedia system:



▶ Select **Route list**.

The list shows the route sections. The current vehicle position is marked on the map.

The current vehicle position is shown with the following information:

- The symbol for the current vehicle position is displayed.
- The name of the road on which you are currently driving is shown.

- The road number of the road on which you are currently driving is shown.

The route list is updated during the journey.

- ▶ **To show route sections:** swipe up or down on the control element.

The route section is shown on the map.

Selecting an alternative route

Requirements:

- The [Suggest alternative route](#) option is switched on (→ page 227).

Multimedia system:



- ▶ Select [Alternative routes](#).
The routes are displayed in accordance with the setting made in the route settings.
The routes are numbered.
- ▶ Select the alternative route.
- ▶ **To show the route on the map:** select [Display on the map](#).
- ▶ Move the map (→ page 240).
- ▶ Set the map scale (→ page 240).

Activating a commuter route

Requirements:

- You have created a profile (→ page 206).
- The [Allow destination suggestions](#) option is switched on (→ page 207).
- The [Activate commuter route](#) option is switched on.
- The multimedia system has gathered sufficient data in order to show destination suggestions.
- Routes have been learned for these destination suggestions.

Multimedia system:



▶▶ [Advanced](#) ▶▶ [Route](#)

- ▶ Activate [Activate commuter route](#).
The display button is activated. The navigation system automatically detects that the vehicle is on a commuter route. It automatically starts a route guidance without voice output.

For the daily commuter route, traffic incidents on the route are also reported when driving without active route guidance.

Switching the automatic filling station search on/off

Multimedia system:



- ▶ Activate or deactivate [Filling station search](#).
When the fuel reserve level is reached, and the display button is switched on, a message appears to start searching for filling stations.

Starting an automatic filling station search

Requirements:

- The automatic filling station search is activated (→ page 230).

Driving situation

The fuel level in the fuel tank reaches the reserve fuel level.

The [Fuel tank reserve level Do you want to start the search for filling stations?](#) message is shown.

- ▶ Select [Yes](#).
The automatic filling station search begins.
The available filling stations along the route or in the vicinity of the vehicle's current position are displayed.
- ▶ Select a filling station.
The address of the filling station is displayed.
- ▶ Calculate the route (→ page 226).
The filling station is set as the destination or the next intermediate destination.
- ▶ **If there are already four intermediate destinations:** select [Yes](#) in the prompt.
The filling station is entered in the route overview. Intermediate destination 4 is deleted.
Route guidance begins.

Starting the automatic service station search

Requirements:

- ATTENTION ASSIST and the [Suggest rest area](#) function are activated (→ page 169).
- There are service stations along the route section ahead.

Driving situation

The [Suggest rest area. Do you want to start the rest area search?](#) message is shown.

- ▶ Select [Yes](#).
The service station search starts. The available service stations along the route or in the vicinity of the vehicle's current position are displayed.
- ▶ Select a service station.
The service station address is displayed.

- ▶ Calculate the route (→ page 226).
The service station is set as the destination or the next intermediate destination.

- ▶ **If there are already four intermediate destinations:** select **Yes** in the prompt.
The service station is entered in the route overview. Intermediate destination 4 is deleted. Route guidance begins.

Showing a stored route on the map

Requirements:

- A USB device with stored routes is connected with the multimedia system.
- The route is stored in the "Routes" folder with the GPS Exchange format (.gpx).

Multimedia system:

→  » Navigation »  Where to?
» STORED ROUTES

- ▶ Select a route.
- ▶ Select **Display on the map**.
- ▶ Move the map (→ page 240).

Starting a saved route

Requirements:

- A USB device with stored routes is connected with the multimedia system.
- The route is stored in the "Routes" folder with the GPS Exchange format (.gpx).

Multimedia system:

→  » Navigation »  Where to?
» STORED ROUTES

- ▶ Select a route.
- ▶ Select **Start route guidance from the beginning** or **Start route guidance from current location**.
Route guidance starts.

- ▶  The route can be saved with  in the menu (→ page 226).

Recording a route

Requirements:

- A USB device is connected with the multimedia system.

Multimedia system:

→  » Navigation »  Where to?
» STORED ROUTES

- ▶ **To start recording:** select **Start to record new route**.
A red recording symbol is shown.
The route is stored on the USB device.
- ▶ **To stop recording:** select **End recording**.

Saving a recorded route

Requirements:

- A USB device is connected with the multimedia system.

Multimedia system:

→  » Navigation »  Where to?
» STORED ROUTES

- ▶ Select a route.
- ▶ Select .
- ▶ Select **Save in "Previous destinations"**.
The route is stored in the "Previous destinations" memory and can be called up from there for route guidance.

Editing a stored route

Requirements:

- A USB device with stored routes is connected with the multimedia system (→ page 265).

Multimedia system:

→  » Navigation »  Where to?
» STORED ROUTES

- ▶ Select a route with .
- ▶ **To enter a name:** select **Change name**.
- ▶ Enter the name.
- ▶ Select **OK**.
- ▶ or
- ▶ When the name has been changed, press the  button.
- ▶ Select **Yes**.
- ▶ **To delete a route:** select **Delete**.
- ▶ Select **Yes**.

Route guidance

Notes on route guidance

⚠ WARNING Risk of distraction from operating integrated communication equipment while the vehicle is in motion

If you operate communication equipment integrated in the vehicle when driving, you will be distracted from the traffic situation. This could also cause you to lose control of the vehicle.

- ▶ Only operate this equipment when the traffic situation permits.
- ▶ If you cannot be sure of this, stop the vehicle whilst paying attention to road and traffic conditions and operate the equipment with the vehicle stationary.

You must observe the legal requirements for the country in which you are currently driving when operating the multimedia system. Route guidance begins once a route has been calculated.

The road and traffic rules and regulations always have priority over multimedia system driving instructions.

Driving instructions are:

- Navigation announcements
- Route guidance displays
- Lane recommendations

If you do not follow the driving instructions or if you leave the calculated route, a new route is calculated automatically.

Driving instructions may differ from the actual road and traffic conditions if:

- The route is diverted
- The direction of a one-way street has been changed

For this reason, you must always observe road and traffic rules and regulations during your journey as well as the prevailing traffic conditions.

The route may differ from the ideal route due to the following:

- Roadworks
- Incomplete digital map data

Notes on GPS reception

The correct function of the navigation system depends amongst other things on GPS reception.

In certain situations GPS reception can be impaired, defective or even not possible, e.g. in tunnels or in multi-storey car parks.

Changing direction overview

Changes of direction are shown in the following displays:

- Detailed image of the junction
 - The display appears when you drive into a junction.
- 3D image
 - The display appears when driving on junction-free, multi-lane roads, for example on motorway exits and motorway interchanges.



Example: 3D image of the upcoming change of direction

- ① Changing direction
- ② Manoeuvre point, above this the current distance to the change of direction
- ③ Current vehicle position

There are three phases when changing direction:

- Preparation phase
 - If there is enough time between the changes of direction, the multimedia system prepares you for the upcoming change of direction. A navigation announcement is issued, e.g. "Prepare to turn right".

The map appears in full-screen mode.

The status line shows: the direction information or the name of the road which is to be turned into and the distance to the change of direction.

- Announcement phase
 - The multimedia system announces the upcoming change of direction, e.g. by announcing "Turn right in 100 m".

The display is split into two parts. The map is displayed on the left; on the right, there is a detailed image of the junction or a 3D image of the upcoming change of direction.

- Change-of-direction phase

The multimedia system announces the imminent change of direction, e.g. by announcing "Now turn right".

The display is split into two parts.

The change of direction takes place when the distance to manoeuvre point ② is shown with 0 m and the symbol for vehicle position ③ has reached manoeuvre point ②.

When the change of direction is complete, the map appears in full-screen mode.

- ① Changes of direction are also shown in the Instrument Display.

Lane recommendations overview

This display appears for multi-lane roads.

The multimedia system can show lane recommendations if the digital map contains the relevant data.



- ① Lane not recommended (grey arrow)
- ② Possible lane (white arrow)
- ③ Recommended lane (white arrow, blue background)

Explanation of the displayed lanes:

- Lane not recommended ①
In this lane, you will not be able to complete the next change of direction without changing lane.
- Possible lane ②
In this lane, you will only be able to complete the next change of direction.
- Recommended lane ③
In this lane, you will be able to complete both the next change of direction and the one after that.

During the change of direction, new lanes may be added.

- ① Lane recommendations can also be shown in the Instrument Display.

- ① Live Traffic Information is not available in all countries.

Using motorway information

Requirements:

- The **Motorway information** option is switched on (→ page 241).



When driving on the motorway, upcoming motorway facilities ① and available service facilities ② are shown in the overview. These include filling stations, car parks, service stations and motorway exits, for example.

- ▶ **To open the display:** select . The entries are sorted according to increasing distance from the current vehicle position.
 - ▶ **To close the display:** tap on the map.
- or
- ▶ **To use motorway information:** select an entry.
 - ▶ If several service facilities are available, select a service facility from the list. The destination address and the map position are shown.
 - ▶ Calculate the route (→ page 226).
- or
- ▶ Search for a POI in the vicinity.
- or
- ▶ Use other functions, e.g. save the destination address of the service facility.

Using quick-access for a destination, alternative route and POIs

Requirements:

- The POI categories are configured for quick-access (→ page 223).



- ▶ If route guidance is active, select . The address of the destination or the next intermediate destination is shown.

Using alternative routes

- ▶ Select [Alternative route](#). The routes are displayed in accordance with the setting made in the route settings. The routes are numbered.
- ▶ Select the alternative route.

Setting a POI as an intermediate destination

- ▶ Select a category symbol, e.g. for a car park.
- ▶ Select a POI from the list. The selection takes place on the route. The destination address is shown. The route can be calculated.
- ▶ **To use POI categories for quick-access:** select a search position [In the vicinity](#), [Near destination](#) or [Along the route](#).
- ▶ Select a POI from the list.

or

- ▶ Enter a search entry into the search field and filter the list.
- ▶ Select a POI from the list. The destination address is shown. The route can be calculated.

Saving the current vehicle position

- ▶ Select [Store position](#). The current vehicle position is saved to the "Previous destinations" memory.

Destination reached

Once the destination is reached, you will see the chequered flag. Route guidance is finished.

When an intermediate destination has been reached, you will see the intermediate destination flag with the number of your intermediate destination. Route guidance is continued.

Switching navigation announcements on/off

- ▶ **To switch off:** during a navigation announcement, press the volume control on the steering wheel or the / button on the multimedia system (→ page 205). The [Spoken driving recommendations have been deactivated](#). message appears.

or

- ▶ Show the navigation menu (→ page 220).

- ▶ Select .

The symbol changes to .

- ▶ **To activate:** select .

The current navigation announcement is played.

The symbol changes to .

- ▶ This function can be added and called up from the favourites within the navigation category.

Switching navigation announcements on or off during a phone call

- ▶ Press the button on the steering wheel.

or

- ▶ Press and hold the / button on the multimedia system.

or

- ▶ Tap on in the media display.
- ▶ Select [Settings](#).
- ▶ Select [System](#).
- ▶ Select [Audio](#).
- ▶ Select [Navigation and traffic announcements](#).
- ▶ Switch [Driving recommendations during call](#) on or off. When the option is switched on, the display button is activated.
- ▶ **To leave the menu:** select .

Adjusting the volume of navigation announcements

Multimedia system:

- ▶ ▶ [Settings](#) ▶ [System](#) ▶ [Audio](#)
- ▶ [Navigation and traffic announcements](#)

- ▶ Select [Driving recommendation vol.](#)

- ▶ Set the volume.

Route guidance is active

- ▶ Turn the volume control on the multifunction steering wheel during a navigation announcement.

or

- ▶ Press the volume rocker switch on the multimedia system up or down.

Switching audio fadeout on or off during navigation announcements

- ▶ Press the  button on the steering wheel.
- or
- ▶ Press and hold the  /  button on the multimedia system.
- or
- ▶ Tap on  in the media display.
- ▶ Select **Settings**.
- ▶ Select **System**.
- ▶ Select **Audio**.
- ▶ Activate or deactivate **Audio fadeout**.

Repeating navigation announcements

Requirements:

- A route has been created.
- Route guidance is active.

Multimedia system:

 **Navigation**

- ▶ Select .
 - ▶ Select .
- The current navigation announcement is repeated.

- ▶  This function can be added and called up from the favourites within the navigation category.

Cancelling route guidance

Requirements:

- A route has been created.
- route guidance is active.

- ▶ Show the navigation menu.
- ▶ Select  in the navigation menu (→ page 220).

Overview of route guidance to an off-road destination

An off-road destination is within the digital map. The map contains no roads that lead to the destination.

You can enter geo-coordinates or a three word address for off-road destinations on the map. Route guidance guides you for as long as possible with navigation announcements and displays on roads that are known to the multimedia system.

Shortly before you reach the last known position on the map, you will hear the "Please follow the direction arrow" announcement, for example. The display shows a direction arrow and the linear distance to the destination.

Overview of route guidance from an off-road location to a destination

In an off-road position, the current vehicle position is located within the digital map on roads that are not available.

These displays appear when route guidance begins:

- A message appears that the road is not on the map.
- A direction arrow that shows the linear direction to the destination.

When the vehicle is back on a road known to the multimedia system, route guidance continues as normal.

Overview of off-road status during route guidance

Due to roadworks, for example, there may be differences between the data on the digital map and the actual course of the road. In such cases, the multimedia system will temporarily be unable to locate the vehicle's current position on the digital map. The vehicle is off-road.

When the vehicle is off-road, the following displays are shown:

- A message appears that the road is not on the map.
- A direction arrow showing the linear direction to the POI.

When the vehicle is back on a road known to the multimedia system, route guidance continues as normal.

Destination

Saving the current vehicle position

Multimedia system:

- ▶    **Navigation**   **Position**
 - ▶ Select **Store position**.
- The current vehicle position is saved to the "Previous destinations" memory.

Using quick-access

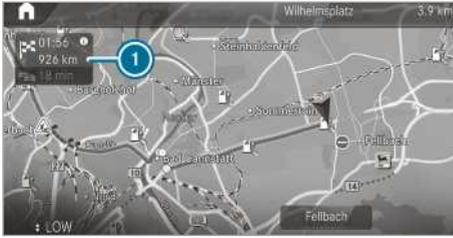

- ▶ If route guidance is active, select . The address of the destination or the next intermediate destination is shown.
- ▶ Select **Store position**.

Editing the previous destinations

Requirements:

- For editing destination suggestions: the **Allow destination suggestions** option is activated (→ page 207).
- The multimedia system has gathered sufficient data in order to show destination suggestions.

Multimedia system:

-  **Navigation** →  **Where to?**
- ▶ **PREV. DESTINATIONS**

The following destinations can be edited:

- Destinations
- Destination suggestions

- ▶ **To no longer display a destination suggestion:** select  for a destination suggestion.
- ▶ Select **Do not suggest**.

Saving the last destination as a favourite

- ① After saving, the destination can be called up via the favourites (→ page 208).
- ▶ Select  for a destination.
- ▶ Select  **Save as favourite**.
- ▶ **To save as a favourite:** select **Save as favourite**.
- ▶ **To save as "Home" address:** select **Save as "Home"**.
- ▶ **To save as "Work" address:** select **Save as "Work"**.

Deleting a previous destination

- ▶ **To delete a destination:** select  for the previous destination.
- ▶ Select **Delete**.
- ▶ Select **Yes**.
- ▶ **To delete all destinations:** select .
- ▶ Select **Delete all**.
- ▶ Select **Yes**.

Route guidance with current traffic reports

Traffic information overview

- ① The services are not available in every country.

Traffic reports can be received with the following services:

- Live Traffic Information
- FM RDS-TMC

It is not possible to use both services simultaneously.

Live Traffic Information or FM RDS-TMC is displayed with a symbol.

- ① Hazard warnings can be received using the Car-to-X service.
- ① There may be differences between the traffic reports received and the actual road and traffic conditions.

Important information on Live Traffic Information:

- Current traffic reports are received via the Internet connection (for selected countries).
- The traffic situation is updated at short, regular intervals.
- In selected countries, the subscription service is available free of charge for a period of three years from the manufacturing date. Subscription information shows the status (→ page 237).

Information on the vehicle's position is regularly sent to Daimler AG. The data is immediately rendered anonymous by Daimler AG and forwarded to the traffic data provider. Using this data, traffic reports relevant to the vehicle's position are sent to the vehicle. The vehicle acts as a sensor for the flow of traffic and helps to improve the quality of the traffic reports.

If you do not wish to transmit a vehicle position, you have the following option:

- You can deactivate the service at Mercedes PRO connect.
- You have the service deactivated at a Mercedes-Benz service centre.

Useful information on FM RDS-TMC:

- A FM RDS-TMC radio station broadcasts traffic reports alongside the radio programme.
- FM RDS-TMC is not available in all countries.

Displaying subscription information for Live Traffic Information

Requirements:

- The vehicle is equipped with Live Traffic Information.

Multimedia system:

   Navigation   Traffic

▶ **To display manually:** select **Live Traffic Subscription Info**.

The traffic data supplier's logo and the status of the subscription are displayed. The subscription is either valid or has expired.

The subscription expiry date is automatically displayed:

- one month before the expiry date
- one week before the expiry date
- on the expiry date

 When the subscription has expired then in selected countries FM RDS-TMC is available. The subscription can be extended (→ page 237).

Registering Live Traffic Information

Requirements:

- The vehicle is equipped with Live Traffic Information.
- You have a user account on the Mercedes PRO website.

The Live Traffic Information service must be registered. This secures the full period of three years.

- ▶ Create a user account at Mercedes PRO at: <http://www.mercedes.pro>. A valid email address is required for this.
- ▶ Register the vehicle using the vehicle identification number (VIN).

- ▶ **Registration in the Mercedes-Benz service centre:** have the connection carried out in a Mercedes-Benz service centre.

Extending a Live Traffic Information subscription

Requirements:

- The vehicle is equipped with Live Traffic Information.
 - You have a user account on the Mercedes PRO website.
- ▶ Call up the Mercedes PRO website.
 - ▶ Call up the Mercedes PRO user account.
 - ▶ Switch to the Mercedes PRO connect online store via the linked vehicle.
 - ▶ Select the Live Traffic Information service.
 - ▶ Select the renewal period.
 - ▶ Add the product to the shopping basket.
 - ▶ Accept the general and specific terms of use. Live Traffic Information remains activated for the selected extension period. Activation begins on the date of extension.

Showing traffic information

Requirements:

- The **Traffic** display is switched on (→ page 238).
- The following traffic displays are switched on (→ page 238):

Traffic incidents

Free-flowing traffic

Delay

Multimedia system:

- ▶ Select **Navigation**.

The map shows the following traffic information:

- traffic incidents, for example:
 - roadworks
 - road blocks
 - warning messages

When route guidance is active, the symbols for traffic incidents will be shown in colour on the route. Off the route they are grey.

- warning message symbols:
 - symbol 

- road safety notes, e.g. when approaching the end of a traffic jam

If the vehicle approaches a danger area on the route, a warning message is displayed on the map. A warning message may also be issued.

- traffic flow information:
 - traffic jam (red line)
 - slow-moving traffic (orange line)
 - heavy traffic (yellow line)
 - free-flowing traffic (green line)
- display for traffic delays on the route lasting at least one minute

Displaying traffic incidents

Requirements:

- The [Traffic incidents](#) display is switched on (→ page 238).

Multimedia system:

  **»» Navigation**  **»» Traffic**

- ▶ Select [Traffic announcements](#).

The list is sorted according to distance and shows the traffic incidents received.

The traffic incidents on the route are shown first.

A traffic incident shows the following information:

- Street number
- Traffic incident symbol
 - On the route: coloured
 - Off the route: grey
- Cause
- Street symbol (traffic incident on the route)
- Distance from current vehicle position

- ▶ Select a traffic incident.

The detailed information is shown, for example the route section.

Showing traffic incidents in the vicinity of the map

- ▶ Select a traffic incident symbol on the map. The details about the traffic incident are displayed.

- ▶ Select .

- ▶ Select [Traffic incidents in vicinity](#).

The map shows the traffic incident symbols in the vicinity.

Traffic incident information is displayed in the status line:

- Traffic incident symbol
- Cause of the traffic incident, e.g. construction work
- Warning message (highlighted red)

- ▶ **To select a traffic incident symbol:** select

 or .

- ▶ **To select a map section:** tap on the touchscreen.

or

- ▶ Press the Touch Control.

- ▶ Move the map.

- ▶ **To return to the navigation map:** tap on

.

or

- ▶ Press the  button on the Touch Control.

Switching the traffic information display on

Multimedia system:

  **»» Navigation** 

- ▶ Activate [Traffic](#).

The display button is activated.

Activating Incidents, Free Flow and Delay

- ▶ Select [Advanced](#).

- ▶ Select [View](#).

- ▶ Select [Map elements](#).

- ▶ In the **TRAFFIC** category, activate the [Traffic incidents](#), [Free-flowing traffic](#) and [Delay](#) entries.

If traffic information has been received, then traffic incidents such as roadworks, road blocks, local area reports (e.g. fog) and warning messages are displayed.

The traffic delay is displayed for the current route. Traffic delays lasting one minute or longer are taken into consideration.

Showing local area messages

Multimedia system:

  **»» Navigation**  **»» Traffic**

- ▶ Select [Area messages](#).

Local area messages are shown, for example fog or heavy rain.

- ▶ Select a local area message.

The details are displayed.

Accepting a detour recommendation after a prompt

Requirements:

- After asking is switched on • in the **DYNAMIC ROUTE GUIDANCE** menu (→ page 227).
- Route guidance is active.
- There are traffic reports for the current route.

If a new route with a shorter driving time is determined, the current and new routes will be shown.

 The notification is shown in another application. Confirm the notification.

 **To accept the new route:** select **Accept recommended detour**.

 **To maintain the current route:** select **Keep to current route**.

Car-to-X-Communication

Overview of Car-to-X-Communication

The following requirements apply for using Car-to-X-Communication:

- The vehicle is equipped with a multimedia system featuring navigation and a communication module with an activated, integrated SIM card.
- You have a user account with Mercedes PRO.
- The Car-to-X-Communication service is activated.

 Car-to-X-Communication is available in selected countries.

The communication module automatically establishes an Internet connection once the ignition is switched on. If there are any hazard warnings, they will be provided shortly thereafter. Depending on the mobile phone connection, the provision takes place from within a second up to about a minute.

Benefits of Car-to-X-Communication:

- Hazards are recognised automatically in the background by the vehicle or may be reported by the driver. These are then sent to vehicles with Car-to-X-Communication in the immediate vicinity.
- If available, current details relating to hazard spots near the vehicle's current position are received.

This gives you sufficient time to adapt your driving style to the traffic conditions.

The use of Car-to-X-Communication requires the regular transmission of vehicle data to Daimler AG. The data is then immediately pseudonymised by Daimler AG. The vehicle data is deleted after an appropriate amount of time has elapsed (several weeks) and is not stored permanently.

 Data which serves as identification is replaced during the pseudonymisation process. In this way, your identity is protected against access by unauthorised third parties.

Displaying hazard warnings

Multimedia system:



 Select **Navigation**.

If hazard warnings are available these will be shown on the map.

The following hazard warnings are shown on the map:

- broken-down vehicles
- accidents
- hazardous weather
- general hazards
- hazard warning lights, when switched on
- mobile roadworks

The display is not available in all countries and regions.

In the Federal Republic of Germany the display is currently available in the Federal State of Hesse.

 If the vehicle is approaching a hazard spot with a vehicle speed of at least 60 km/h, the voice output "Traffic incident ahead" is issued.

The voice output is not issued for hazardous weather.

Sending hazard warnings

Automatically detected hazard warnings are sent by the vehicle.

 **To send a hazard warning yourself:** tap on the media display when the map is shown. The navigation menu is shown.

 Select .

 Select **Report traffic incident**. A prompt is shown.

- ▶ Select **Yes**.
The **Thank you for supporting accident prevention** message appears.

Map and compass

Setting the map scale

Multimedia system:



Zooming in

- ▶ When the map is shown, tap twice quickly with one finger on the media display.
or
- ▶ Move two fingers apart on the media display.

Zooming out

- ▶ Tap with two fingers on the media display.
or
 - ▶ Move two fingers together on the media display.
- i** You can set the unit of measurement of the map scale (→ page 217).

Moving the map

Multimedia system:



- ▶ Move the finger in any direction on the touchscreen when the map is shown.

When the map has been moved the following information appears in the status line, for example:

- The distance from the vehicle's current position is shown.
- Information about the current map position is shown, e.g. the name of the road.

The following functions are available:

- Select a destination on the map (→ page 225).
 - Select a POI (→ page 223).
 - Show traffic incidents on the map (→ page 238).
This function is not available in all countries.
- ▶ **To reset the map to the current position of the vehicle:** tap on symbol

Rotating the map

- ▶ With two fingers, rotate anti-clockwise or clockwise on the media system display.

Selecting the map orientation

Multimedia system:



▶ **Advanced**

- ▶ Select **View**.
- ▶ Select **Map orientation**.
- ▶ Select an option.
The **•** dot indicates the current setting.

The following options are available:

- **2D heading up** option: the 2D map view is aligned to the direction of travel.
- **2D north up** option: the 2D map view is displayed so that north is always at the top.
- **3D** option: the 3D map view is aligned to the direction of travel.

or

- ▶ **Using quick-access:** repeatedly tap or press on the compass symbol on the map. The view changes in the sequence **3D, 2D heading up to 2D north up**.

If the map is moved, it can switch between **3D** and **2D north up**.

Selecting POI symbols for the map display

Multimedia system:



POIs include filling stations and hotels, for example. These can be displayed as symbols on the map. Not all POIs are available everywhere.

Personal POIs are destinations which you have saved on a USB device, for example.

- i** The display of POI symbols on the map can be activated or deactivated as a favourite.

- ▶ **To switch on/off using quick-access:** if available, switch **POI symbols** on or off. The POI symbols for the selected categories are shown on the map.

or

- ▶ **To switch on/off in the menu:** select **Advanced**.
- ▶ Select **View**.
- ▶ Select **Map elements**.
- ▶ Select **POI symbols**.
The **POI SYMBOLS** menu is shown.
- ▶ Switch **Display POIs** on or off.

Selecting categories

- ▶ Select **POI SYMBOLS** in the **All categories** menu .
- ▶ Switch **Show all** on or off. When the option is switched on, the POI symbols for all categories are shown on the map.

or

- ▶ Select the categories and sub-categories (if available) .
- ▶ Activate or deactivate the categories. The POI symbols for the selected categories are shown on the map.

Selecting personal POI categories

- ▶ Select **POI SYMBOLS** in the **Personal POIs** menu .
- ▶ Select a category .
- ▶ Switch **Display on the map** on or off. When the display is switched on and the vehicle approaches a personal POI in this category, a visual and audible notification can be issued.
- ▶ **To set a notification when approaching:** select a category or a personal POI .
- ▶ Switch **Visual warning** and **Acoustic notification** on or off.

Switching display of categories for quick-access on/off

- ▶ Switch a category on or off in the **POI SYMBOLS** menu.

Resetting the POI symbol display

- ▶ Select **POI SYMBOLS Reset POIs** in the menu. The settings are reset to the standard settings.

Selecting text information for display on the map

Multimedia system:



▶▶ **Advanced**

- ▶ Select **View**.
- ▶ Select **Text information**.
- ▶ Select an option in the **FOOTER** category. The • dot indicates the current setting.

The following options are available:

- **Current street** option
The street you are currently on is shown in the bottom bar.

When the map is moved, the street name, the POI name or the area name appears under the crosshair.

- The **Geo-coordinates** option shows the following information in the bottom bar:
 - Longitude and latitude
 - Elevation
The elevation shown may deviate from the actual elevation.
 - Number of satellites from which a signal can be received
When the map is moved, this information does not appear.
- **None** option
The media display shows no text information in the bottom bar.

Switching motorway information on/off

Multimedia system:



- ▶ **Using quick-access:** switch **Motorway information** on or off. The display button is activated or off.

or

- ▶ **Using the menu:** select **Advanced**.
- ▶ Select **View**.
- ▶ Select **Text information**.
- ▶ Activate or deactivate **Motorway information**. When the display button is switched on, additional information about the motorway facilities ahead appears during the motorway journey. These include car parks, service stations and motorway exits, for example.

Displaying the next intersecting street

Requirements:

- Route guidance is not active.

Multimedia system:



▶▶ **Advanced**

- ▶ Select **View**.
- ▶ Select **Text information**.
- ▶ Activate **Next intersecting street**. The display button is activated. If the option is switched on and the journey continues without route guidance, the name of the next intersecting street will be displayed at the upper edge of the display.

Displaying the map version

Multimedia system:



» Advanced

▶ Select **View**.

▶ Select **Map version**.

The detail information is displayed.

- ① The online map update service from Mercedes PRO connect can be used to update the map data (→ page 242). A message is shown in the media display when a new map version is available.
- ① Information about new versions of the digital map can be obtained from a Mercedes-Benz service centre.

Overview of avoiding an area for the route

You can define areas along a route that you would like to avoid.

Motorways or multi-lane expressways, which are routed through an area to be avoided are taken into account for the route.

Avoiding a new area for the route

Multimedia system:



» Advanced » Route » Avoid options

» Avoid areas

▶ Select **Avoid new area**.

▶ **To start in the map:** select **Using map**.

▶ Move the map (→ page 240).

▶ **To start via destination search:** select **Via address entry**.

▶ Enter the address (→ page 221).

▶ Select the destination in the list or accept with **OK**.

The map appears.

▶ **To show an area:** tap or press on the control element.

A red rectangle appears. This designates the area that should be avoided.

▶ **To change the map scale:** move two fingers together or apart on the media display.

The map is zoomed in or out.

▶ **To set an area:** press on the control element. The area is entered into the list.

Changing an area to be avoided

Multimedia system:



» Advanced » Route » Avoid options

» Avoid areas

▶ Select an area in the list.

▶ Select **Edit**.

▶ **To move an area on the map:** swipe in any direction on the control element.

▶ **To change the size of the area:** tap or press on the control element.

▶ Swipe up or down on the control element.

▶ Tap or press on the control element.

▶ **To take account of an area for the route:** select an area from the list.

▶ Activate **Avoid area**.

The display button is activated.

If route guidance is active, a new route is calculated.

If there is no route yet, the setting is carried over to the next route guidance.

The route can include an area that is to be avoided in the following cases:

- the destination is located in an area that is to be avoided.
- the route includes motorways or multi-lane expressways which pass through an area to be avoided.
- there is no sensible alternative route.

Deleting an area

Multimedia system:



» Advanced » Route » Avoid options

» Avoid areas

▶ **To delete an area:** select an area in the list.

▶ Select **Delete**.

▶ Confirm the prompt with **Yes**.

▶ **To delete all areas:** if at least two areas to avoid are set, select **Delete all**.

▶ Confirm the prompt with **Yes**.

Overview of updating the map data

Updating at the Mercedes-Benz service centre

The digital maps generated by the map software become outdated in the same way as conventional road maps. Optimal route guidance can

only be provided by the navigation system in conjunction with the most up-to-date map data. Information about new versions of the digital map can be obtained from a Mercedes-Benz service centre.

You can receive updates to the digital map there.

Online map update

The online map update service from Mercedes PRO connect can be used to update the map data.

This service is not available in all countries.

You can use the following update options:

- For one region (automatic map update)
For automatic map updates the **Automatic online updates** system setting must be activated (→ page 218).
- For several or all regions (manual map update)

The map data will first be downloaded onto a storage medium and then updated on the multimedia system.

Further information on the online map update <http://www.mercedes.pro>.

Overview of map data

Your vehicle is supplied with map data at the factory. Depending on the country, map data for your region is either pre-installed or the map data is supplied on a data storage medium.

If the map data on your vehicle has been installed at the factory and you wish to reinstall it, you do not need to enter the activation code.

For map data that you have purchased in the form of a data storage medium, you must enter the accompanying activation code.

 If you save the map data on a data storage medium with the online map update service, no entry is required. The activation code is stored on the data storage medium during the downloading process.

Observe the following when entering the activation code:

- The activation code can be used for one vehicle
- The activation code is not transferable
- The activation code has six digits

In the event of the following problems, please contact a Mercedes-Benz service centre:

- The multimedia system does not accept the activation code
- You have lost the activation code

Displaying the compass

Multimedia system:



 Select **Compass**.

The compass display shows the following information:

- the current direction of travel with bearing (360° format) and compass direction
- longitude and latitude coordinates in degrees, minutes and seconds
- height (rounded)
- number of GPS satellites from which a signal can be received

The information is not available in every country.

Displaying Qibla

Multimedia system:



This function is not available in all countries.

 Select **Qibla**.

The arrow on the compass shows the direction to Mecca in relation to the current direction of travel.

The number of satellites received is shown.

Setting the map scale automatically

Multimedia system:



 **Advanced**

 Select **View**.

 Select **Map orientation**.

 Activate **Auto zoom**.

The display button is activated. The map scale is set automatically depending on your driving speed and the type of road.

 The automatically selected map scale can be changed manually. After a few seconds, this is automatically reset.

Displaying the satellite map

Multimedia system:



» Advanced

- ▶ Select **View**.
- ▶ Select **Map elements**.
- ▶ Activate or deactivate **Satellite map**.
If the display button is activated, satellite maps are displayed in map scales from 2 km.
If the display button is deactivated, satellite maps are not displayed in map scales from 2 km to 20 km.

i The satellite maps for these map scales are not available in all countries.

Displaying weather information and other map contents

Requirements:

- You have a user account with Mercedes PRO connect.
- The service is available.
- The service has been activated.

Multimedia system:



» Advanced

- ▶ Select **View**.
- ▶ Select **Map elements**.
- ▶ Scroll up and show the **ONLINE MAP CONTENTS** category.
The available services are displayed. The services are provided by Mercedes PRO connect.
- ▶ Switch on a service, e.g. **Weather**.
Current weather information is displayed on the navigation map, e.g. temperature or cloud cover. The service information is not shown in all map scales, e.g. weather symbols.

Further information about available services and about displaying information in the map scales: <http://www.mercedes.pro>

The services are not available in every country.

Parking service

Notes for the parking service

⚠ WARNING Risk of accident and injury due to not observing the maximum permitted access height

If the vehicle height exceeds the maximum permitted access height for multi-storey car parks and underground car parks, the vehicle roof as well as other vehicle parts could be damaged.

There could be a risk of injury to the vehicle occupants.

- ▶ Before driving into a multi-storey car park or underground car park observe the locally signposted access height.
- ▶ If the vehicle height, including any additional equipment, exceeds the maximum permitted access height, do not drive into the multi-storey car park or underground car park.

This service is not available in all countries.

Selecting parking options

! **NOTE** Before selecting the parking option

The data is based on the information made available by the respective service provider.

Mercedes-Benz assumes no responsibility for the accuracy of the information provided relating to the multi-storey car park or the parking facility.

- ▶ Always pay attention to the local information and circumstances.

Requirements:

- The navigation services option is available, subscribed to and activated in the Mercedes PRO portal.
The parking service is within the scope of the navigation service.
- **Parking** is activated (→ page 245).

Multimedia system:



- ▶ Tap on **P** on the map.
- ▶ Select a parking option.
The map shows the parking options in the vicinity.

The following information is displayed (if available):

- Destination address, distance from current vehicle position and arrival time
- Information on the multi-storey car park/car park facility

For example, opening times, parking charges, current occupancy, maximum parking time, **maximum access height**.

The maximum access height shown by the parking service does not replace the need for observation of the actual circumstances.

- Available payment options (Mercedes pay, coins, bank notes, cards)
- Details on parking tariffs
- Number of available parking spaces
- Payment method (e.g. at the parking machine)
- Services/facilities at the parking option
- Telephone number

▶ Calculate the route (→ page 226).

The following functions can also be selected (if available):

- Search for POIs in the vicinity.
- Save the destination.
- Place a call at the destination.
- Share the destination using NFC or QR code.
- Call up the web address.
- Show the destination on the map.

Displaying parking options on the map

Requirements:

- The navigation services option is available, subscribed to and activated in the Mercedes PRO portal.

The parking service is within the scope of the navigation service.

Multimedia system:



▶ Activate **Parking**.

The display button is activated. The parking options within the vicinity of the current vehicle position are shown.

Telephone

Telephony

Telephone menu overview



- ① Bluetooth® device name of the currently connected mobile phone/the mobile phone in the foreground (two phone mode)
- ② Battery status of the connected mobile phone
- ③ Signal strength of the mobile phone network
- ④ Options
- ⑤ Device manager
- ⑥ To switch mobile phones (two phone mode)
- ⑦ Numerical pad
- ⑧ Contact search

Bluetooth® profile overview

Bluetooth® profile of the mobile phone	Function
PBAP (Phone Book Access Profile)	Contacts are automatically displayed in the multimedia system
MAP (Message Access Profile)	Message functions can be used

- You can receive incoming calls and messages with the mobile phone in the background.
- You can interchange the mobile phone in the foreground and background any time (→ page 248).

① Irrespective of this, Bluetooth® audio functionality can be used with any mobile phone (→ page 265).

Telephony operating modes overview

The following telephone operating modes are available:

- One mobile phone is connected to the multimedia system via Bluetooth® (→ page 247).
- Two mobile phones are connected with the multimedia system via Bluetooth® (two phone mode).
 - You can use all the functions of the multimedia system with the mobile phone in the foreground.

Notes on telephony

⚠ WARNING Risk of distraction from operating integrated communication equipment while the vehicle is in motion

If you operate communication equipment integrated in the vehicle when driving, you will be distracted from the traffic situation. This could also cause you to lose control of the vehicle.

- ▶ Only operate this equipment when the traffic situation permits.
- ▶ If you cannot be sure of this, stop the vehicle whilst paying attention to road

and traffic conditions and operate the equipment with the vehicle stationary.

⚠ WARNING Risk of distraction from operating mobile communication equipment while the vehicle is in motion

If you operate mobile communication equipment when driving, you will be distracted from the traffic situation. This could also cause you to lose control of the vehicle.

▶ Only operate this equipment when the vehicle is stationary.

You must observe the legal requirements for the country in which you are currently driving when operating mobile communication equipment in the vehicle.

Further information can be obtained from a Mercedes-Benz service centre or at: <http://www.mercedes-benz.com/connect>.

Information on telephony

The following situations can lead to the call being disconnected while the vehicle is in motion:

- there is insufficient network coverage in the area
- you move from one transmission/reception station to another and no communication channels are free
- the SIM card used is not compatible with the network available
- a mobile phone with "Twincard" is logged into the network with the second SIM card at the same time

The multimedia system supports calls in HD Voice® for improved speech quality. A requirement for this is that the mobile phone and the mobile phone network provider of the person you are calling support HD Voice®.

Depending on the quality of the connection, the voice quality may fluctuate.

Connecting a mobile phone

Requirements:

- Bluetooth® is activated on the mobile phone (see the manufacturer's operating instructions).
- Bluetooth® is activated on the multimedia system (→ page 215).

Multimedia system:



Searching for a mobile phone

- ▶ Select **Connect new device**.

Connecting a mobile phone (authorisation using Secure Simple Pairing)

- ▶ Select a mobile phone.
- ▶ A code is displayed in the multimedia system and on the mobile phone.
- ▶ **If the codes match:** confirm the code on the mobile phone.

i For older mobile phone models, enter a one to sixteen-digit number code on the mobile phone and on the multimedia system for authorisation.

i Up to 15 mobile phones can be authorised on the multimedia system. Authorised mobile phones are reconnected automatically.

i The connected mobile phone can also be used as Bluetooth® audio equipment (→ page 265).

Connecting a second mobile phone (two phone mode)

Requirements:

- At least one mobile phone is already connected to the multimedia system via Bluetooth®.

Multimedia system:



- ▶ Select **Connect new device**.
- ▶ Select the mobile phone.
- ▶ Select **With <Mobile phone>**. The selected mobile phone is connected to the multimedia system.

Functions of the mobile phone in two phone mode

Functions overview

Functions of the mobile phone in the foreground	Functions of the mobile phone in the background
Full range of functions	Incoming calls and messages

Interchanging mobile phones (two phone mode)

Multimedia system:



▶ Select .

You can also interchange the two connected mobile phones in the following submenus:

- Contacts
- Call list
- Messages

After interchanging the mobile phones in one of the submenus, the mobile phone in the foreground is replaced by the mobile phone in the background.

Changing the function of a mobile phone

Multimedia system:



Activating a function

▶ Select a grey symbol in the line of a mobile phone.
The corresponding function is activated.

Deactivating a function

- ▶ **A function is active:** select the coloured symbol in the line of a mobile phone.
The mobile phone is disconnected from the multimedia system.
- ▶ **Several functions are active:** select a coloured symbol in the line of a mobile phone.
The corresponding function is deactivated.

Replacing a mobile phone

Multimedia system:



- ▶ **No authorised mobile phone available:** select [Connect new device](#).
- ▶ Select a mobile phone.
- ▶ **Newly authorised mobile phone:** confirm the number code on the mobile phone.

Using in single telephone mode

- ▶ Select [Only Device_name](#).
A newly authorised mobile phone is connected in single telephone mode.
If the mobile phone has already been authorised and connected in single telephone mode, it is connected again in single telephone mode.

If a mobile phone has already been authorised and connected in two phone mode with another mobile phone, it will be connected in future in single telephone mode.

Using in two phone mode

- ▶ Select [With <Mobile phone>](#).
A newly authorised mobile phone is connected with the selected mobile phone in two phone mode.
If the mobile phone has already been authorised and connected in single telephone mode, it will be connected in future with the selected mobile phone in two phone mode.
If the mobile phone was previously connected with another mobile phone, this connection is cancelled.

Disconnecting/de-authorising a mobile phone

Multimedia system:



- ▶ Select  in the line of the mobile phone.
- ▶ **To disconnect:** select [Disconnect](#).
If applicable, the mobile phone will be automatically reconnected when the vehicle is next started.
- ▶ **To de-authorise:** select [Deauthorise](#).

Information on Near Field Communication (NFC)

NFC enables short-range wireless data transfer or (re)connection of a mobile phone with the multimedia system.

The following functions are available without having authorised a mobile phone:

- Transferring a URL or a contact to be viewed in the multimedia system (see the manufacturer's operating instructions).
- Setting up the vehicle's Wi-Fi access data via the system settings (→ page 216).

Further information can be obtained at: <http://www.mercedes-benz.com/connect>

Using the mobile phone with Near Field Communication (NFC)

Requirements:

- NFC is activated on the mobile phone (see the manufacturer's operating instructions)
- The mobile phone's screen is switched on and unlocked (see the manufacturer's operating instructions)

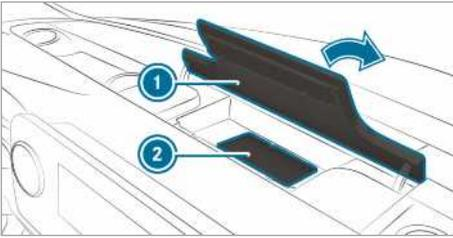

- ▶ Open the flap of stowage compartment ❶ above the media display.
- ▶ **To connect a mobile phone:** hold the NFC area of the mobile phone (see manufacturer's operating instructions) on mat ❷ or place the mobile phone on it.
- ▶ Follow the additional prompts on the media system display to connect the mobile phone. Connect the mobile phone in single telephone mode (→ page 247). Connect the mobile phone in two phone mode (→ page 247).
- ▶ **To replace a mobile phone:** hold the NFC area of the mobile phone (see manufacturer's operating instructions) on the mat or place the mobile phone on it.
- ▶ Follow the additional prompts on the media system display to replace the mobile phone in one or two phone mode (→ page 248).
- ▶ If required, confirm the prompts on your mobile phone (see the manufacturer's operating instructions).

Further information can be found at: <http://www.mercedes-benz.com/connect>

Setting the reception and transmission volume

Requirements:

- A mobile phone is connected (→ page 247).

Multimedia system:



This function ensures optimal language quality.

- ▶ Select **Volume**.
- ▶ Set **Reception volume** and **Transmission volume**.

Further information on the recommended reception and transmission volume: <http://www.mercedes-benz.com/connect>

Setting the ringtone

Multimedia system:



- ❶ Please note that the respective mobile phone must be selected for adjustment of the reception and transmission volume.
- ▶ Select **Ringtones**.
- ▶ Set the ringtone.
- ❷ If the mobile phone supports the transfer of the ringtone, you will hear the ringtone of the mobile phone instead of that of the vehicle.

Starting/stopping mobile phone voice recognition

Requirements:

- The mobile phone in the foreground is connected with the multimedia system (→ page 247).

Starting mobile phone voice recognition

- ▶ Press and hold the button on the multi-function steering wheel for more than one second.
You can use mobile phone voice recognition.

Stopping mobile phone voice recognition

- ▶ Press the or button on the multi-function steering wheel.
- ❶ If a mobile phone is connected via Smartphone Integration, the voice recognition of this mobile phone is started or stopped.

Calls

Telephone operation

Multimedia system:



Making a call by entering the numbers

- ▶ Select .
- ▶ Enter a number.
- ▶ Select .
- ▶ The call is made.

Accepting a call

- ▶ Select **Accept**.

Rejecting a call

- ▶ Select **Reject**.

Ending a call

- ▶ Select .

Activating functions during a call

The following functions are available during a call:

-  **End call**
-  **Microphone off**
-  **Numerical keypad** (show to send DTMF tones)
-  **Add call**
-  **Transfer to phone** (an active call in hands-free mode is transferred over to the telephone)

- ▶ Select a function.

Conducting calls with several participants

Requirements:

- There is an active call (→ page 249).
- Another call is being made.

Switching between calls

- ▶ Select the contact.
The selected call is active. The other call is on hold.

Activating a call on hold

- ▶ Select the contact of the call on hold.

Conducting a conference call

- ▶ Select  **Create conferen. call.**
The new participant is included in the conference call.

Ending an active call

- ▶ Select  **End call.**

- ⓘ On some mobile phones, the call on hold is activated as soon as the active call is ended.

Accepting/rejecting a waiting call

Requirements:

- There is an active call (→ page 249).

If you receive a call while already in a call, a message is displayed.

Depending on the mobile phone and mobile network operator you will hear a call-waiting sound.

In addition, in two phone mode you will hear an acoustic signal when the call goes through to the other (not yet active) mobile phone.

- ▶ Select  **Accept.**

The incoming call is active.

If only one mobile phone is connected with the multimedia system, the previous call will be put on hold.

If during a call you accept a call with the other mobile phone when in two phone mode then the existing call is ended.

- ▶ Select  **Reject.**

- ⓘ This function and behaviour depends on your mobile phone network provider and the mobile phone (see the manufacturer's operating instructions).

Contacts

Information about the contacts menu

The contacts menu contains all contacts from existing data sources, e.g. mobile phone or data storage medium.

Depending on the data source, you have the following number of contacts:

- Permanently saved contacts: 3,000 entries
- Contacts loaded from the mobile phone: 5,000 entries per mobile phone

From the contacts menu, you can perform the following actions:

- Make a call, for example call a contact (→ page 251)
- Navigation (→ page 224)
- Compose messages (→ page 254)
- Additional options (→ page 252)

If a mobile phone is connected to the multimedia system (→ page 247) and automatic calling up (→ page 250) is activated, the mobile phone's contacts are displayed in the address book.

The multimedia system can show suggestions based on frequently used contacts as well as incoming and outgoing calls (→ page 207). These are shown at the top of the contact list.

Downloading mobile phone contacts

Multimedia system:



- ▶ Select the connected mobile phone.
- ▶ Select **Contacts & call list.**

Automatically

- ▶ To switch [Synchronise contacts automatically](#) on: activate the LED symbol.

Manually

- ▶ To deactivate [Synchronise contacts automatically](#): deactivate the LED symbol.
- ▶ Select [Synchronise contacts](#).

Calling up contacts

Multimedia system:



The following options can be used to search for contacts:

- searching by initials
- searching by name
- searching by phone number
- ▶ Enter characters into the search field.
- ▶ Select the contact.
Details for the contact are shown.

A contact can contain the following details:

- Phone numbers
Telephone numbers can be saved as global favourites (→ page 208).
- Navigation addresses
- Geo-coordinates
- Internet address
- E-mail addresses
- Relation (if set)
- Information on messenger services

Editing the format of a contact's name

Multimedia system:



- ▶ Select [General](#).
- ▶ Select [Name format](#).

The following options are available:

- [Surname, First name](#)
- [Surname First name](#)
- [First name Surname](#)
- ▶ Select an option.

Overview of importing contacts

Contacts from various sources

Source	Requirements:
 USB device	The USB device is connected with the USB port.
 Bluetooth® connection	If the sending of vCards via Bluetooth® is supported, vCards can be received on mobile phones or netbooks, for example. Bluetooth® is activated in the multimedia system and on the respective device (see the manufacturer's operating instructions).

Importing contacts into the contacts menu

Multimedia system:



▶▶ [Import contacts](#)

- ▶ Select an option.

Saving a mobile phone contact

Multimedia system:



- ▶ Select   in the line of the mobile phone contact.

- ▶ Select .

- ▶ Select [Save in vehicle](#).

- ▶ Select [Yes](#).

The contact saved in the multimedia system is identified by the  symbol.

Calling a contact

Multimedia system:



- ▶ Select  [Search contacts](#).

- ▶ Enter characters into the search field.

- ▶ Select the contact.

- ▶ Select the telephone number.

The number is dialled.

Selecting further options in the contacts menu

Multimedia system:



- ▶ Select in the line of the contact.
- ▶ Select .

Depending on the stored data, the following options are available:

- [Add voice tag/Delete voice tag](#)
- [Set relation/Remove relation](#)
- [Send DTMF tones](#) (for a number with DTMF tones)

The function is available when a call is active.

- ▶ Select an option.

Selecting options for suggestions in the contacts menu

Requirements:

- A profile has been created (→ page 206).
- The [Allow contact suggestions](#) setting is switched on (→ page 207).

Multimedia system:



- ▶ Select [Call list](#).
- ▶ Select in the line of a suggested contact.

The following options are available:

- [Save as favourite](#)
The suggestions are saved as global favourites and do appear on the home screen.
- [Do not suggest](#)

- ▶ Select an option.

Deleting contacts

Requirements:

- The contacts are saved in the vehicle.
- To delete an individual contact, this has been imported manually into the vehicle.

Multimedia system:



Deleting all contacts

- ▶ Select .
- ▶ Select [General](#).

- ▶ Select [Delete contacts](#).
- ▶ Select an option.

Deleting a contact

- ▶ Select .
- ▶ Select in the line of the contact.
- ▶ Select .
- ▶ Select [Delete contact](#).
- ▶ Select [Yes](#).

Saving a contact as a favourite

Multimedia system:



- ▶ Select a contact.
- ▶ Select in the line of the contact.
- ▶ Select the telephone number.
The contact is stored as a favourite in the telephone menu overview.

Deleting favourites in the telephone menu overview

Multimedia system:



- ▶ Select a favourite in the telephone menu overview (→ page 252).
- ▶ Press and hold the favourite.
- ▶ Select [Delete](#).
- ▶ Select [Yes](#).

Deleting all favourites

- ▶ Tap on in the media display.
- ▶ Select [Phone](#).
- ▶ Select .
- ▶ Select the connected phone.
- ▶ Select [Contacts & call list](#).
- ▶ Select [Do you want to delete all favourites?](#)
- ▶ Select [Yes](#).

Call list

Overview of the call list

Depending on whether your mobile phone supports the PBAP Bluetooth® profile or not, this can have different effects on the presentation and functions of the call list.

If the PBAP Bluetooth® profile is supported, the effects are as follows:

- The call lists from the mobile phone are displayed in the multimedia system.

- When connecting the mobile phone, you may have to confirm the connection for the PBAP Bluetooth® profile.

If the PBAP Bluetooth® profile is not supported, the effects are as follows:

- The multimedia system generates a call list independently as soon as calls are made in the vehicle.
- The call list is not synchronised with the call lists in the mobile phone.

The multimedia system can show suggestions based on frequently used contacts as well as incoming and outgoing calls (→ page 207). These are shown at the top of the call list.

Making a call from the call list

Multimedia system:

 **Phone**

- ▶ Select  **Call list**.
- ▶ Select an entry.
The call is made.

Calling up additional options in the call list

Multimedia system:

 **Phone**

- ▶ Select  **Call list**.
- ▶ For previously stored contacts: select  in the line of an entry.
The search results are displayed.
- ▶ For contacts who have not been stored: select .

Selecting options for suggestions in the call list

Requirements:

- A profile has been created (→ page 206).
- The **Allow contact suggestions** setting is switched on (→ page 207).

Multimedia system:

 **Phone**

- ▶ Select  **Call list**.
- ▶ Select  in the line of a suggested entry.
The following options are available:
 - **Save as favourite**
 - **Do not suggest**
- ▶ Select an option.

Deleting the call list

Multimedia system:

 **Phone** 

- ▶ Select the connected mobile phone.
- ▶ Select **Contacts & call list**.
- ▶ Select **Delete call list**.
- ▶ Select **Yes**.
- ▶  This function is only available if your mobile does not support the PBAP Bluetooth® profile.

Text messages

Overview of the messaging functions

In the messages menu you can receive and send text messages.

If the connected mobile phone supports the Bluetooth® MAP profile, the message function can be used on the multimedia system.

You can obtain further information about settings and supported functions of Bluetooth®-capable mobile phones from a Mercedes-Benz Service Centre or at: <http://www.mercedes-benz.com/connect>

Some mobile phones require further settings after being connected to the multimedia system (see manufacturer's operating instructions).

Configuring displayed messages

Multimedia system:

 **Phone** 

- ▶ Select the connected mobile phone.
- ▶ Select **Message display**.
The following options are available:
 - **All messages**
 - **New and unread messages**
 - **Messages while the vehicle is in motion**
 - **Off** (the message function is no longer available.)
- ▶ Select a setting.

Reading messages

Multimedia system:

 **Phone** **Messages**

- ▶ Select a message sequence with a contact.

Using the read-aloud function

- ▶ Select a message.

Select .
The message is read aloud.

Dictating and sending a new message

Requirements:

- There is an Internet connection.

Multimedia system:

Select a new message .

Adding a recipient

- Select .
- Select a contact.

Dictating text

- Select .
The dictating function is started.
- Say the message.
After the voice message has been processed, it is shown as text.

Sending a message

- Select [Send](#).
-  When the vehicle is stationary you can use the keyboard to write a message. No Internet connection is required to use the keyboard.

Replying to a message in the messaging history

Multimedia system:

- Select a message sequence with a contact.
- Select .
The dictating function is started.
- Say the message.
After the voice message has been processed, it is shown as text.
- Select [Send](#).

Using message templates

Multimedia system:

Using a template as a new message

- Select a new message .
- Add a recipient using .
- Select a template .

Answering a message with a template

- Select a message sequence with a contact.
- Select the  symbol.
- Select a template .

Forwarding a message

Multimedia system:

- Select a message sequence with a contact.
- Press and hold on a message.
- To forward a message:** select [Forward](#).

Calling a message sender

Multimedia system:

- Select a message sequence with a contact.
- Select .
- Select [Call](#).

Using telephone numbers or URLs from a text message

Requirements:

- An Internet connection is available to call up a URL.

Multimedia system:

- Select a message sequence with a contact.
- Select a telephone number or a URL in the message.
If a URL is selected the web browser opens.
If a telephone number is selected the following options are available:
 - [Call](#)
 - [Write new text message](#)
- Select an option.

Deleting a message

Multimedia system:

- Select a contact.
- Press and hold on a message.
- To delete the message:** select [Delete](#).

Apple CarPlay™

Overview of Apple CarPlay™

⚠ WARNING Risk of distraction from information systems and communications equipment

If you operate information and communication equipment integrated in the vehicle when driving, you will be distracted from the traffic situation. This could also cause you to lose control of the vehicle.

- ▶ Only operate this equipment when the traffic situation permits.
- ▶ If you cannot be sure of this, stop the vehicle whilst paying attention to road and traffic conditions and operate the equipment with the vehicle stationary.

You must observe the legal requirements for the country in which you are currently driving when operating the multimedia system.

iPhone® functions can be used via the multimedia system using Apple CarPlay™. They are operated using the touchscreen, Touch Control or the Siri® voice-operated control system. You can activate the voice-operated control system by pressing and holding the  button on the multifunction steering wheel.

When using Apple CarPlay™ via the voice-operated control system, the multimedia system can still be operated via LINGUATRONIC (→ page 188).

Only one mobile phone at a time can be connected via Apple CarPlay™ to the multimedia system.

Also for use of Apple CarPlay™ with two phone mode, only one additional mobile phone can be connected using Bluetooth® with the multimedia system.

The availability of Apple CarPlay™ may vary according to the country.

The service provider is responsible for this application and the services and content connected to it.

Information on Apple CarPlay™

When Apple CarPlay™ is being used, the iPod® media source is not available for the respective iPhone®.

Only one route guidance can be active at a time. If route guidance is active on the multimedia sys-

tem, it is closed when route guidance is started on the mobile phone.

Connecting an iPhone® via Apple CarPlay™

Requirements:

- The current version of your device's operating system is being used (see the manufacturer's operating instructions).
- The full range of functions for Apple CarPlay™ is only available with an Internet connection.
- The iPhone® is connected to the multimedia system via the USB port  using a suitable cable (→ page 265).

Multimedia system:

-  ▶ Mercedes PRO & Apps
- ▶ Smartphone ▶ Apple CarPlay
- ▶ Start Apple CarPlay

- ▶ Alternative: If Apple CarPlay™ is active (e.g. when music is being played or the navigation system is being used), you can call up the application using the ,  or  buttons (→ page 204).

Accepting/rejecting the data protection provisions

For the initial start of the application: a message with the data protection provisions appears.

- ▶ Select **Accept & start**.

Exiting Apple CarPlay™

- ▶ Press the  button.
- ⓘ Apple CarPlay™ starts automatically when the iPhone® is connected with the system using a cable. If Apple CarPlay™ was not displayed in the foreground before disconnecting, the application starts in the background when reconnected. You can call up Apple CarPlay™ in the main menu.

Calling up Apple CarPlay™ sound settings

Multimedia system:

-  ▶ Mercedes PRO & Apps
- ▶ Smartphone ▶ Apple CarPlay ▶ 
- ▶ Select sound settings.

Setting control of the application buttons

Multimedia system:

- ↳  » Mercedes PRO & Apps
- » Smartphone » Apple CarPlay » 
- » General

- ▶ To switch **Control via application buttons** on: activate the LED symbol.
- ▶ To deactivate **Control via application buttons**: deactivate the LED symbol.

Ending Apple CarPlay™

- ▶ **To end the connection of Apple Carplay™ (cable):** disconnect the connection via the connecting cable between the iPhone® and multimedia system.

- ⓘ Mercedes-Benz recommends disconnecting the connecting cable only when the vehicle is stationary.

Android Auto

Android Auto overview

⚠ WARNING Risk of distraction from information systems and communications equipment

If you operate information and communication equipment integrated in the vehicle when driving, you will be distracted from the traffic situation. This could also cause you to lose control of the vehicle.

- ▶ Only operate this equipment when the traffic situation permits.
- ▶ If you cannot be sure of this, stop the vehicle whilst paying attention to road and traffic conditions and operate the equipment with the vehicle stationary.

You must observe the legal requirements for the country in which you are currently driving when operating the multimedia system.

Mobile phone functions can be used with Android Auto using the Android operating system on the multimedia system. It is operated using the touchscreen or the voice-operated control system. You can activate the voice-operated control system by pressing and holding the  button on the multifunction steering wheel.

When using Android Auto via the voice-operated control system, the multimedia system can still be operated via LINGUATRONIC (→ page 188).

Only one mobile phone at a time can be connected via Android Auto to the multimedia system.

This also applies to two phone mode.

The availability of Android Auto and Android Auto apps may vary according to the country.

The service provider is responsible for this application and the services and content connected to it.

Information on Android Auto

While using Android Auto, various functions of the multimedia system, for example the media source Bluetooth® audio, are not available.

Only one route guidance can be active at a time. If route guidance is active on the multimedia system, it is closed when route guidance is started on the mobile phone.

Connecting a mobile phone via Android Auto

Requirements:

- The mobile phone supports Android Auto from Android 5.0.
- The Android Auto app is installed on the mobile phone.
- In order to use the telephone functions, the mobile phone must be connected to the multimedia system via Bluetooth® (→ page 247).
If there was no prior Internet connection, this is established with the use of the mobile phone with Android Auto.
- The mobile phone is connected to the multimedia system via the USB port  using a suitable cable (→ page 265).
- There is an Internet connection for the full range of functions for Android Auto.

Multimedia system:

- ↳  » Mercedes PRO & Apps
- » Smartphone » Android Auto
- » Start Android Auto

- ▶ Alternative: If Android Auto is active (e.g. when music is being played or the navigation system is being used), you can call up the application using the ,  or  buttons (→ page 204).

- ⓘ The first activation of Android Auto on the multimedia system must be carried out when the vehicle is stationary for safety reasons.

Accepting/rejecting the data protection provisions

A message with the data protection provisions appears.

▶ Select **Accept & start**.

ⓘ The first activation of Android Auto on the multimedia system must be carried out when the vehicle is stationary for safety reasons.

Exiting Android Auto

▶ Press the  button.

ⓘ Android Auto starts automatically when the mobile phone is connected with the system using a cable. If Android Auto was not displayed in the foreground before disconnecting, the application starts in the background when reconnected. You can call up Android Auto in the main menu.

Calling up the Android Auto sound settings

Multimedia system:

  ▶ **Mercedes PRO & Apps**
▶ **Smartphone** ▶ **Android Auto** ▶ 

▶ Select sound settings.

Setting control of the application buttons

Multimedia system:

  ▶ **Mercedes PRO & Apps**
▶ **Smartphone** ▶ **Android Auto** ▶ 
▶ **General**

▶ To switch **Control via application buttons** on: activate the LED symbol.

▶ To deactivate **Control via application buttons**: deactivate the LED symbol.

Ending Android Auto

▶ Disconnect the connecting cable between the mobile phone and multimedia system. Mercedes-Benz recommends disconnecting the connecting cable only when the vehicle is stationary.

Transferred vehicle data with Android Auto and Apple CarPlay™

Overview of transferred vehicle data

When using Android Auto or Apple CarPlay™, certain vehicle data is transferred to the mobile phone. This enables you to get the best out of selected mobile phone services. Vehicle data is not directly accessible.

The following system information is transmitted:

- software release of the multimedia system
- system ID (anonymised)

The transfer of this data is used to optimise communication between the vehicle and the mobile phone.

To do this, and to assign several vehicles to the mobile phone, a vehicle ID is randomly generated.

This has no connection to the vehicle identification number (VIN) and is deleted when the multimedia system is reset (→ page 219).

The following vehicle status data is transmitted:

- transmission position engaged
- distinction between parked, standstill, rolling and driving
- day/night mode of the instrument cluster

The transfer of this data is used to alter how content is displayed to correspond to the driving situation.

The following position data is transmitted:

- coordinates
- speed
- compass direction
- acceleration direction

This data is only transferred while the navigation system is active, in order to improve it (e.g. so it can continue functioning when in a tunnel).

Online and Internet functions

Internet connection

Information on connecting to the Internet

⚠ WARNING Risk of distraction from information systems and communications equipment

If you operate information and communication equipment integrated in the vehicle when driving, you will be distracted from the traffic situation. This could also cause you to lose control of the vehicle.

- ▶ Only operate this equipment when the traffic situation permits.
- ▶ If you cannot be sure of this, stop the vehicle whilst paying attention to road

and traffic conditions and operate the equipment with the vehicle stationary.

You must observe the legal requirements for the country in which you are currently driving when operating the multimedia system.

▲ WARNING Risk of distraction from operating mobile communication equipment while the vehicle is in motion

If you operate mobile communication equipment when driving, you will be distracted from the traffic situation. This could also cause you to lose control of the vehicle.

▶ Only operate this equipment when the vehicle is stationary.

You must observe the legal requirements for the country in which you are currently driving when operating mobile communication equipment in the vehicle.

Depending on the vehicle's equipment, you can establish an Internet connection in the following ways:

- **Vehicles with a communication module:**
Internet use including Mercedes PRO connect services and data roaming (→ page 258).
The availability of Mercedes PRO connect is country-dependent. You can check the availability of Mercedes PRO in your country at the following page: <http://www.mercedes.pro>
- **Vehicles without a communication module:**
 - via Bluetooth® with a data-enabled mobile phone (→ page 259)
 - via Wi-Fi with a data-enabled mobile phone (→ page 258)

The Internet functions can only be used to a limited degree whilst driving.

Internet function via the communication module

On vehicles with a built-in communication module, the Internet connection is established via an integrated SIM card.

To use online functions via the communication module the following conditions must be met:

- The vehicle is equipped with a permanently installed communication module.
- A Mercedes PRO account is available (→ page 199).

- Mercedes PRO connect is active and ready for operation.
- Mercedes PRO connect is activated for Internet access.

i To use web browsers, Internet radio or Wi-Fi hotspot, the data volumes must also be purchased directly from the wireless service provider. To purchase data volumes you have to connect your mobile device using the vehicle's Wi-Fi hotspot and register with the wireless service provider (→ page 216).

Contact a Mercedes-Benz service centre to find out whether it is possible to purchase data volume in your country.

When data volumes are available, you can use the web browser, the Internet radio and the Wi-Fi hotspot for mobile devices.

Setting up an Internet connection via Wi-Fi without a communication module

Requirements:

- the Wi-Fi function is activated on the multimedia system (→ page 215).
- the Wi-Fi function is activated on the external device (see the manufacturer's operating instructions).
- Internet access via Wi-Fi is activated (see the manufacturer's operating instructions).

The Internet connection via Wi-Fi is restricted or does not function if:

- the mobile phone is switched off.
- mobile data use is deactivated on the mobile phone.
- the Wi-Fi function is deactivated on the multimedia system.
- the Wi-Fi function is deactivated on the external device.
- Internet access via Wi-Fi is deactivated on the external device.

Multimedia system:

- ▶  ▶ Settings ▶ System
- ▶ Wi-Fi & Bluetooth ▶ Internet settings
- ▶ Connect via Wi-Fi
- ▶ Select the network.
- ▶ Log in to a Wi-Fi network (→ page 215).

Setting up an Internet connection via Bluetooth® without a communication module

Requirements:

- The mobile phone support the Bluetooth® profile PAN (Personal Area Network).
- The mobile phone is connected to the multimedia system via Bluetooth® (→ page 247).

The Internet connection via Bluetooth® is restricted or does not function if:

- the mobile phone is switched off.
- the mobile phone is connected to an additional mobile phone.
- the mobile phone network coverage is insufficient.
- mobile data use is deactivated on the mobile phone.
- the Bluetooth® function on the multimedia system is switched off and the mobile phone is to be connected via Bluetooth®.
- the Bluetooth® function is switched off on the mobile phone and the mobile phone is to be connected via Bluetooth®.
- neither the mobile phone network nor the mobile phone allow simultaneous use of a phone and an Internet connection.
- the mobile phone has not been enabled for Internet access via Bluetooth®.

If a mobile phone is connected to the multimedia system for the first time via Bluetooth®, you will be assisted through the process of setting up an Internet connection.

The Internet connection can also be configured manually.

Further information can be obtained at <http://www.mercedes-benz.com/connect> or from a Mercedes-Benz Service Centre.

Multimedia system:

-  >> Settings >> System
- >> Wi-Fi & Bluetooth >> Internet settings
- >> Connect via Bluetooth
- ▶ Select the mobile phone.
The Internet connection is established.

Establishing an automatic Internet connection

Multimedia system:

-  >> Settings >> Wi-Fi & Bluetooth
- >> Internet settings
- ▶ Highlight the mobile phone.
- ▶ Select .
- ▶ Activate  Permanent Internet connection.

Cancelling Internet access permission for a mobile phone

Multimedia system:

-  >> Settings >> System
- >> Wi-Fi & Bluetooth >> Internet settings
- ▶ Select  in the line of the mobile phone.
- ▶ Select Delete configuration.
- ▶ Select Yes.

Displaying mobile phone details

Multimedia system:

-  >> Settings >> System
- >> Wi-Fi & Bluetooth >> Internet settings
- ▶ Select  in the line of the mobile phone.
- ▶ Select Details.

Establishing an Internet connection

Multimedia system:

-  >> Mercedes PRO & Apps
- ▶ For example, select  Browser.
- ⓘ The multimedia system usually establishes the Internet connection automatically. If the multimedia system is not connected to the Internet, the Internet connection is established when an Internet application is used.

Setting automatic disconnection of the Internet connection without a communication module

Multimedia system:

-  >> Settings >> System
- >> Wi-Fi & Bluetooth >> Internet settings
- ▶ Select  in the line of the mobile phone.
- ▶ Select Disconnect when inactive.

The following options are available:

- 5 minutes
- 10 minutes
- 20 minutes

- **Unlimited**
- ▶ Select an option.

Connection status

Connection status overview



- ① Display of existing connection and reception field strength of the communication module or of the connected Bluetooth® device

Displaying the connection status

Multimedia system:

▶ Settings ▶ System
▶ Wi-Fi & Bluetooth

▶ Select **Internet status**.

- ① When connected via Wi-Fi or a Bluetooth® device, the approximate data volume transmitted is displayed. The exact values can be requested from your mobile phone network provider.
- ① In the case of a connection via the communication module the following status information is shown:
- Type of network
 - Status online/offline

Web browser

Calling up a web page

⚠ WARNING Risk of distraction from information systems and communications equipment

If you operate information and communication equipment integrated in the vehicle when

driving, you will be distracted from the traffic situation. This could also cause you to lose control of the vehicle.

- ▶ Only operate this equipment when the traffic situation permits.
- ▶ If you cannot be sure of this, stop the vehicle whilst paying attention to road and traffic conditions and operate the equipment with the vehicle stationary.

You must observe the legal requirements for the country in which you are currently driving when operating the multimedia system.

Multimedia system:

▶ Mercedes PRO & APPS
▶ Browser

Calling up a new web page

- ▶ Select **URL**.
 - ▶ Entering a web address
 - ▶ Select **ok**.
- ① Websites cannot be shown while the vehicle is in motion.

Calling up a website from the browser history

- ▶ To call up the previous or next page from the history: select **←** or **→**.
- ① Availability of web browsers is country-dependent.
- Vehicles with a communication module: to use web browsers, data volumes must also be purchased via Mercedes PRO or directly from the wireless service provider. To purchase data volumes you have to connect your mobile device using the vehicle's Wi-Fi hotspot and register with the wireless service provider (→ page 216).

Web browser overview

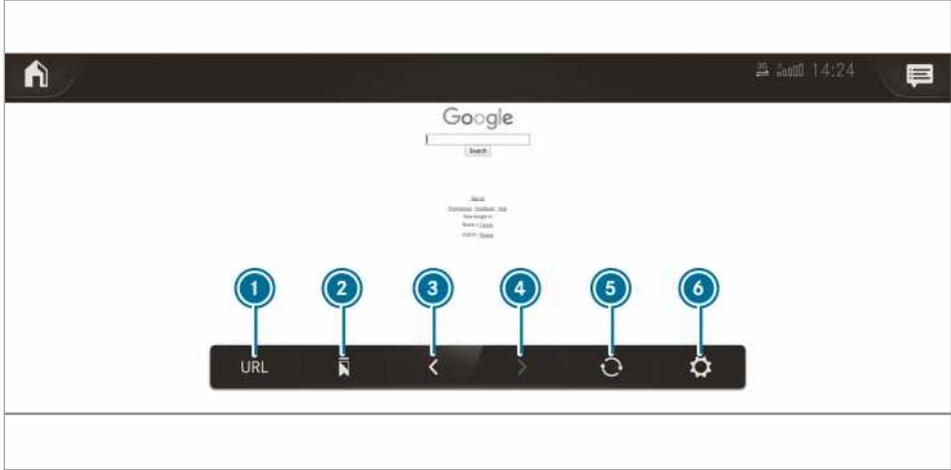

- | | | |
|-------------|----------------------|-------------------|
| ① URL entry | ③ Web page, back | ⑤ To refresh/stop |
| ② Bookmarks | ④ Web page, forwards | ⑥ Options |

Calling up web browser options

Multimedia system:

MERCEDES PRO & APPS
 >> Browser >>

The following functions are available:

- [Bookmarks](#)
- [Options](#) with the settings:
 - [Browser settings](#)
 - [Delete browser data](#)

- ▶ Select an option.
- ▶ Change the settings.

Calling up the web browser settings

Multimedia system:

MERCEDES PRO & APPS
 >> Browser >> >> [Browser settings](#)

The following functions are available:

- [Block popups](#)
- [Enable Javascript](#)
- [Enable cookies](#)
- ▶ Switch a function on or off .

Deleting Internet history

Multimedia system:

MERCEDES PRO & APPS
 >> Browser >>
 >> [Delete browser data](#)

The following options are available:

- [All](#)
- [Cache](#)
- [Cookies](#)
- [Entered URLs](#)
- [Form data](#)

- ▶ Select an option.
- ▶ Select [Yes](#).

Managing bookmarks

Multimedia system:

MERCEDES PRO & APPS
 >> Browser

- ▶ Select .

Selecting a bookmark

- ▶ Select an entry.

Creating a bookmark

- ▶ Select [Add current site to bookmarks](#).
- ▶ Enter a name.
- ▶ Select [Bestätigen](#) (Confirm).

Editing a bookmark

- ▶ Select  after a bookmark.
- ▶ Select **Edit**.
- ▶ Enter a name.
- ▶ Select **Bestätigen** (Confirm).

Deleting a bookmark

- ▶ Select  after a bookmark.
- ▶ Select **Delete**.
- ▶ Select **Yes**.

Closing the browser

Multimedia system:

- ▶   **MERCEDES PRO & APPS**
- ▶   **Browser**
- ▶ Select .

Internet radio

Calling up Internet radio

Requirements

- ① The Internet radio function is only available in certain countries.

Internet radio overview



- | | | |
|--|----------------|---------------------------|
| ① Additional information on the current station | ④ Options | ⑧ Station search |
| ② Display (if connected to private user account) | ⑤ Favourites | ⑨ Selected category |
| ③ Data transfer rate | ⑥ To start/end | ⑩ Internet radio provider |
| | ⑦ To browse | |

- The service is available.
- The data volume is available. Depending on the country, data volume may need to be purchased.
- A fast Internet connection for data transmission free of interference. The services are country-dependent. For more information, consult a Mercedes-Benz service centre.

Multimedia system:

- ▶   **Radio**

- ▶ Select **TuneIn radio**. The Internet radio menu appears. The last station set starts playing.
- ① The connection quality depends on the local mobile phone reception.

Selecting and connecting to Internet radio stations

Multimedia system:

 >> Radio >> Tuneln radio

- ▶ Select .
 - ▶ Select a category.
 - ▶ Select a station.
- The connection is established automatically.

or

- ▶ Select the search field.
- ▶ Enter a station name using the entry field.

 A relatively large volume of data can be transmitted when using Internet radio.

Saving/deleting Internet radio stations as favourites

Multimedia system:

 >> Radio >> Tuneln radio

- ▶ Select a station.
 - ▶ Select .
- The list of saved favourite stations appears.
- ▶ Select [Add to favourites](#).

or

- ▶ Create an account for the online provider (Tuneln radio) and then log in on the multimedia system.
- Your favourites are imported to the multimedia system.

Deleting favourites

- ▶ Select a station.
- ▶ Select .
- ▶ Select [Delete favourites](#).

Setting Internet radio options

Multimedia system:

 >> Radio >> Tuneln radio >> 

The following options are available:

- [Select stream](#): select the stream quality.
 - [Login to Tuneln account](#): log in to your Tuneln user account.
 - [Log out of account](#): log out of your Tuneln user account.
- ▶ Select an option.

Calling up the station list for the category last selected

Multimedia system:

 >> Radio >> Tuneln radio

- ▶ Press the cover of the current station.
- Depending on how the station was selected, a station list is shown.

Media

Information about media mode

Information about supported formats and data storage media

 **WARNING** Risk of distraction when handling data storage media

If you handle a data storage medium while driving, your attention is diverted from the traffic conditions. This could also cause you to lose control of the vehicle.

- ▶ Only handle a data storage medium when the vehicle is stationary.

The multimedia system supports the following formats and data media:

Permissible file systems	FAT32, exFAT, NTFS
Permissible data carriers	USB devices, iPod®/iPhone®, MTP devices, Bluetooth® audio equipment
Supported formats:	Audio: MP3, WMA, AAC, WAV, FLAC, ALAC

- The multimedia system supports a total of up to 50,000 files.
- Data storage media up to 2 TB are supported (32-bit address space).

-  Observe the following notes:
 - Due to the wide range of USB devices available on the market, playback cannot be guaranteed for all USB devices.
 - MP3 players must support Media Transfer Protocol (MTP).

Information on copyright protection and trademarks

Audio files that you create or reproduce yourself for playback are generally subject to copyright protection. In many countries, reproductions, even for private use, are not permitted without

the prior consent of the copyright holder. Make sure that you know about the applicable copyright regulations and that you comply with these.



Manufactured under licence from Dolby Laboratories. Dolby, Dolby Audio and the double-D symbol are trademarks of Dolby Laboratories.



Gracenote, the Gracenote logo and logotype, "Powered by Gracenote", MusicID and Playlist Plus are either registered trademarks or trademarks of Gracenote, Inc. in the United States and/or other countries.



For DTS Patents, see <http://patents.dts.com>. Manufactured under licence from DTS Licensing Limited. DTS, the Symbol, & DTS and the Symbol together are registered trademarks, and DTS TruVolume is a trademark of DTS, Inc.® DTS, Inc. All Rights Reserved.

Overview of the media menu

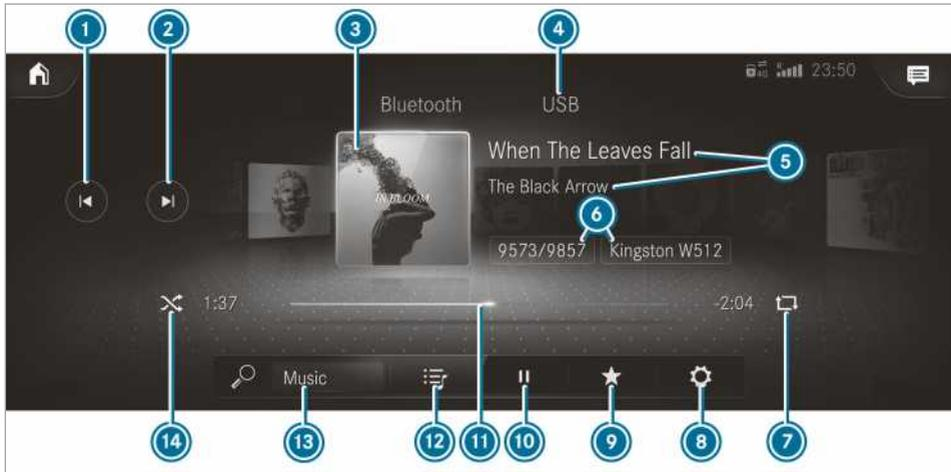

- | | | |
|---------------------------------|---|---------------------|
| ① Previous track or fast rewind | ⑥ Current track number/
track in playback list and
active data storage medium | ⑩ Controls playback |
| ② Next track or fast forward | ⑦ Repeat | ⑪ Timeline |
| ③ Album cover | ⑧ Settings | ⑫ Categories |
| ④ Active media source | ⑨ Additional options | ⑬ Music search |
| ⑤ Track and artist | | ⑭ Random playback |

Connecting the data storage media to the multimedia system

Connecting USB devices

! **NOTE** Damage caused by high temperatures

High temperatures can damage USB devices.

- ▶ Remove the USB device after use and take it out of the vehicle.

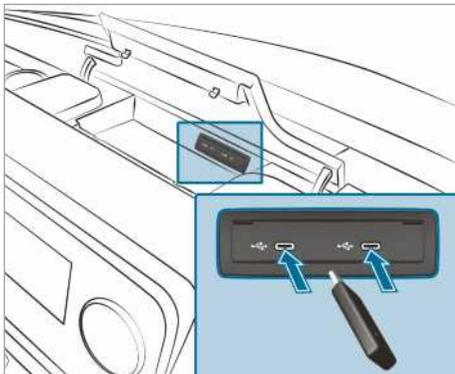

The multimedia connection unit is found in the stowage compartment in the centre console and has two type C USB ports.

- ▶ Connect the USB device to the USB port.

ⓘ When connecting several Apple® devices simultaneously, pay attention to the order in which the devices are connected. The multimedia system only connects with the device that is connected first. Additional Apple® devices that are connected at the same time are only supplied with power.

Searching for and authorising a Bluetooth® audio device

Requirements:

- Bluetooth® is activated on the multimedia system and audio equipment.
- The audio equipment supports the Bluetooth® audio profiles A2DP and AVRCP.
- The audio equipment is "visible" for other devices.

Multimedia system:



Authorising a new Bluetooth® audio device

- ▶ Select [Connect new device](#).
Detected equipment is displayed in the device list.
- ▶ Select an audio device.
Authorisation starts. A code is displayed on the multimedia system and on the mobile phone.
- ▶ If the codes are identical, confirm on the audio equipment.
- ▶ Select [Only as Bluetooth audio device](#).
The Bluetooth® audio equipment is connected with the multimedia system.

Connecting previously authorised Bluetooth® audio equipment

- ▶ Select a Bluetooth® audio device from the list.
The connection is established.

Starting media playback

A data storage medium is connected to the multimedia system.

Multimedia system:



- ▶ Select [USB](#) or [Bluetooth](#) as the media source.

Controlling media playback

Multimedia system:



- ▶ **To pause playback:** select
- ▶ **To continue playback:** select
- ▶ **To repeat a track:** select .
For the repeat function there are the following settings:
 - **Select once:** the active playlist is repeated.
 - **Select twice:** the current track is repeated.
 - **Select three times:** the repeat function is deactivated.
- ▶ **To play back tracks in random order:** select .

- ▶ **To wind a track forwards or backwards:** tap on the desired point on the timeline.
- ▶ **To select the next track:** select .
- ▶ **To select the previous track:** select .
- ▶ **To scroll through tracks quickly:** press and hold or .
- ▶ **To show the current track list:** select the track image shown.

Additional options for setting media playback

Multimedia system:



Calling up additional options

- ▶ Select .
The additional options are shown.

The following options are available:

- [Surprise mix](#)
A playlist with randomly selected tracks is created.
- [Add to favourite songs](#)
The current track is added to the favourite songs.
- [Delete from favourite songs](#)
The current track is removed from the favourite songs.
- ▶ Select an option.

Media search

Information about the search function in categories

Under you can search through all available media files. There are several categories available for selection. The categories shown depend on the connected device and data format.

Available categories with Bluetooth® audio equipment:

- [Current tracklist](#)
The folders and categories of the connected device are shown.

Available categories with audio files:

- [Current tracklist](#)
- [Playlists](#)
- [Folder](#)
- [Albums](#)

- Artists
- Tracks
- Favourite songs
- Frequently played
- Most recently added
- Mood (→ page 267)
- Music genres
- Year
- Composers
- Select by cover
- Podcasts (Apple® devices)
- Audiobooks (Apple® devices)

Available categories with video files:

- Folder
- Videos

 The categories are available as soon as the entire media content has been read in and analysed.

Starting a search in categories

Multimedia system:



- ▶ Select a category.
The media files are shown corresponding to the selected category, e.g. all albums will be shown for the **Albums** category.

Sorting results shown or playing back all media found

- ▶ Select .
- ▶ **To play back all results found in the category:** select **Play all**.
If, for example, the album category is active, all albums found by the desired artist will be played back.
- ▶ **To sort results alphabetically:** select **Sort from A-Z**.
- ▶ **To sort results in reverse alphabetical order:** select **Sort from Z-A**.

 The available options depend on the selected category and the connected device.

Using the keyword search

Multimedia system:



In the categories under  you can use the keyword search with free text input to look for content.

- ▶ Select a category.
- ▶ Select **Search**.
A keyboard for character entry appears.
- ▶ Enter the term searched for.
-  The search begins with the first character entered. The more characters entered the more concrete the search results become.
- ▶ Select the desired entry from the result list.
If the selected result is an album, song or a playback list then playback is started. If the selected result is a new category then this is opened in the search.

Searching for a track according to mood

Multimedia system:



Using the My Music search, you can find music tracks suitable for a mood.

- ▶ Select **Mood**.
A grid with the following moods appears:
 - Positive
 - Calm
 - Dark
 - Energetic
- ▶ Pull the controller to the desired position.
The system searches for tracks that are suitable for the mood entered.

Radio

Switching on the radio

Multimedia system:



- ▶ Alternatively: press the  button.
The radio display appears. You will hear the last station played on the last frequency band selected.

Radio overview



- ① Active frequency band
- ② Station name or set frequency
- ③ Artist, title, album and radio text
- ④ Options
- ⑤ Full screen/DAB slideshow
- ⑥ Mute function
- ⑦ Station list
- ⑧ Search

Setting the frequency band

Multimedia system:



- ▶ Select a frequency band.

Selecting a radio station

Multimedia system:



- ▶ Swipe to the left or right on the control element.

Calling up the radio station list

Multimedia system:



- ▶ Select . The station list appears.
- ▶ Select a station.

Searching for radio stations using station names or direct frequency entry

Multimedia system:



- ▶ Select .
- ▶ Select .
- ▶ Enter a station name or frequency.
- ▶ Select a station.

Storing radio stations

Multimedia system:



- ▶ Select a radio station.

Memory slots are available in station presets

- ▶ Select .
- or
- ▶ Press and hold on the radio station.

Replacing an entry in the station presets

- ▶ Press and hold on an entry in the station presets.

- ▶ Select **Yes**.

Editing station presets

Multimedia system:



Moving stations:

- ▶ Press and hold a stored station.
- ▶ Select **Move**.
- ▶ Move the station to the new position.

Deleting stations:

- ▶ Press and hold a station.
- ▶ Select **Delete**.

Replacing a station:

- ▶ Press and hold a station.
- ▶ Select **Replace radio station**.

Activating or deactivating the frequency fix function

Multimedia system:



- ▶ Select **Frequency fix** to switch on or off. If the function is activated, the set frequency is kept even if the reception is poor.

Switching traffic announcements on/off

Multimedia system:



- ▶ Switch **Traffic announcements** on or off.

Setting the traffic information service volume increase

Multimedia system:



- ▶ Select **Navigation and traffic announcements**.
- ▶ Select **Traffic announc. vol. increase**.
- ▶ Adjust the value.
- ▶ Accept the value with

Displaying radio text

Multimedia system:



- ▶ Activate or deactivate **Display radio text information**.

Sound

Tone settings

Information about the sound system

The sound system is available for all functions in the radio and media modes. The settings, for example for the equaliser, effect the playback of all media sources.

Calling up the sound menu

Multimedia system:



The following functions are available:

- Equaliser
- Balance and Fader
- Auto. volume adjustment

- ▶ Select a sound menu.

Adjusting treble, mid-range and bass settings

Multimedia system:



- ▶ Set **TREBLE**, **MID** or **BASS**.

Activating/deactivating automatic volume adjustment

Multimedia system:



Automatic volume adjustment compensates for differing volumes when changing between audio sources.

- ▶ Activate or deactivate **Auto. volume adjustment**.

Adjusting the balance/fader

The availability of this function depends on the vehicle equipment.

Multimedia system:



- ▶ Adjust the balance and fader.

Notes on loading guidelines

▲ DANGER Risk of poisoning from exhaust gases

Combustion engines emit poisonous exhaust gases, such as carbon monoxide. Exhaust gases can enter the vehicle interior if the rear-end door is open when the engine is running, especially if the vehicle is in motion.

- ▶ Always switch off the engine before opening the rear-end door.
- ▶ Never drive with the rear-end door open.

▲ WARNING Risk of injury from unsecured objects in the vehicle

When objects are unsecured or inadequately secured, they can slip, tip over or be thrown about, striking vehicle occupants.

This also applies to:

- luggage or loads
- seats which have been removed and are being transported in the vehicle in an exceptional case

There is a risk of injury, particularly in the event of braking manoeuvres or abrupt changes in direction.

- ▶ Always stow objects in such a way that they cannot be tossed about.
- ▶ Before travelling, secure objects, luggage or load to prevent them slipping or tipping over.
- ▶ When a seat is removed, keep it preferably outside the vehicle.

▲ WARNING Risk of injury from inadequate stowage of objects

If you do not adequately stow objects in the vehicle interior, they could slip or be tossed around and thereby strike vehicle occupants. In addition, cup holders, open stowage spaces and mobile phone brackets cannot always restrain the objects they contain in the event of an accident.

There is a risk of injury, particularly in the event of sudden braking or a sudden change in direction.

- ▶ Always stow objects in such a way that they cannot be tossed around in these or similar situations.
- ▶ Always make sure that objects do not project from stowage spaces, luggage nets or stowage nets.
- ▶ Close all sealable stowage spaces before you start your journey.
- ▶ Stow and secure objects that are heavy, hard, pointed, sharp-edged, fragile or too large in the load compartment.

▲ WARNING Risk of burning from the tailpipe or tailpipe trim

The tailpipe and tailpipe trim can become very hot. If you come into contact with these car parts, you could burn yourself.

- ▶ Always be particularly careful when in the vicinity of the tailpipe and tailpipe trims and supervise children very closely when in this area.
- ▶ Before any contact, allow the car parts to cool down.

If you are using a roof rack, please note the maximum roof load and the maximum load capacity of the roof rack.

You will find information about the maximum roof load in the "Technical data" chapter and information about roof racks in the "Carrier systems" section .

Camera-based driving systems and the sensor functions of the inside rearview mirror may be impaired if you are transporting a load on the roof and it protrudes more than 40 cm over the edge of the roof. Therefore, make sure that the load does not overhang by more than 40 cm.

The handling characteristics of your vehicle are dependent on the load distribution. Therefore, please observe the following notes when loading:

- when transporting a load, never exceed the permissible gross mass or the permissible axle loads for the vehicle (including occupants).
- the load must not protrude above the upper edge of the seat backrests.
- if possible, always transport the load in the load compartment.
- fasten the load to the tie-down eyes and spread the load as evenly as possible.

- use tie-down eyes and fastening components which are suitable for the weight and size of the load.

- if the rear bench seat is not occupied, insert the seat belts crosswise into the buckle of the opposite seat belt.

Load distribution

! **NOTE** Risk of damage to the floor covering

Excessive point loading on the load compartment floor or on the load area can negatively affect the driving characteristics and could damage the floor covering.

- ▶ **Vehicles with rear-wheel drive:** distribute the load uniformly. When doing so, ensure that the overall centre of gravity of the load is always as low and close to the centre as possible and between the axles near the rear axle.
- ▶ **Vehicles with front-wheel drive:** distribute the load uniformly. When doing so, ensure that the overall centre of gravity of the load is always as low and close to the centre as possible and between the axles near the front axle.
- ▶ **Vehicles with all-wheel drive:** distribute the load uniformly. When doing so, ensure that the overall centre of gravity of the load is always as low and close to the centre as possible and between the axles.

Excessive point loading on the load compartment floor or on the load area can negatively affect the driving characteristics and could damage the floor covering.

On panel vans and crewbuses:

- always transport the load in the load compartment.
- always fasten the load to the rear bench seat backrests.
- move large and heavy loads as far towards the front of the vehicle as possible against the rear bench seat. Stow loads flush with the rear bench seat.
- always additionally secure the load with suitable load securing aids or lashing material.
- the load must not protrude above the upper edge of the seat backrests.
- transport loads behind seats that are not occupied.

Securing loads

Notes on load securing

! **WARNING** Risk of accident and injury due to incorrect use of the lashing straps

If you attach the lashing strap incorrectly when securing loads, the following may occur in the event of abrupt changes in direction, braking manoeuvres or an accident:

- the tie-down eyes may become detached or the lashing strap may tear if the permissible load is exceeded.
- the load cannot be restrained.

This may cause the load to slip, tip over or be flung about, striking vehicle occupants.

- ▶ Always tension the lashing straps in the proper manner and only between the described tie-down eyes.
- ▶ Always use lashing straps designed specifically for the loads.

- i** Observe the information relating to the maximum loading capacity of the individual lashing points. If you combine various lashing points to secure a load, always take the maximum loading capacity of the weakest lashing point into account. During maximum full-stop braking, forces may act which can multiply the weight of the load. Always use several lashing points to distribute and spread the load. Spread the load evenly between the lashing points or tie-down eyes.

Always observe the operating instructions or the lashing strap manufacturer's instructions for the operation of the lashing strap.

Observe the information relating to the maximum loading capacity of the lashing points (→ page 357).

As the driver, you are responsible for ensuring the following:

- The load is secured against slipping, tipping, rolling or falling off.

Take usual traffic conditions as well as swerving or full brake application and bad roads into account.

- The applicable requirements and guidelines relating to load-securing practices are met.
If this is not the case, this may constitute a punishable offence, depending on local legislation and any ensuing consequences. Observe country-specific laws.

Make sure that the load is secure before every journey and at regular intervals during a long journey. Adjust the load securing as necessary. Information on how to secure loads correctly can be obtained from the manufacturers of load securing aids or lashing material for load-securing, for example.

When securing loads, observe the following:

- Fill spaces between the load and the load compartment walls or wheel wells. For this purpose, use rigid load securing aids, such as wedges, wooden fixings or padding.
- Attach secured and stabilised loads in all directions.

Use the lashing points or tie-down eyes and the loading rails in the load compartment or on the load surface.

Only use lashing material, such as lashing rods, lock rods or lashing nets and lashing straps, which has been tested in accordance with current standards (e.g. DIN EN). Always use the lashing points closest to the load; pad sharp edges.

Loads, and heavy loads in particular, should preferably be secured using the tie-down eyes.

- i** You will obtain lashing material tested in accordance with current standards (e.g. DIN EN) from any specialist company or from a qualified specialist workshop.

Notes on the partition

Without a partition, vehicles that are approved as commercial vehicles (N1, N2) do not fulfil ISO 27956, which describes the equipment for properly securing a load in delivery vehicles. If the vehicle is used to transport goods, retrofitting the partition is strongly recommended, as properly securing the load in vehicles without a partition will always be a complex operation.

Overview of lashing points

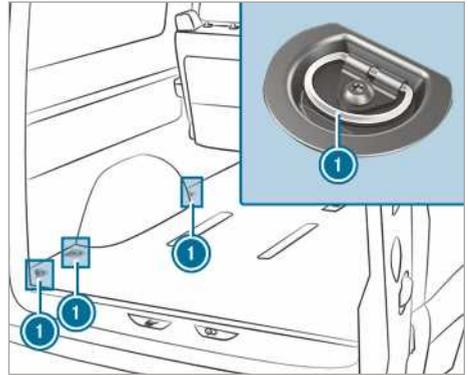

Lashing points (example: crewbus)

- 1** Tie-down eyes

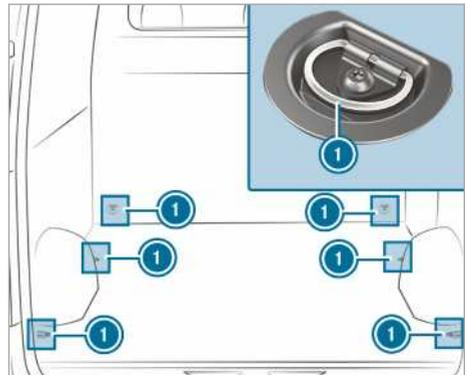

Lashing points (example: panel van without loading rails)

- 1** Tie-down eyes

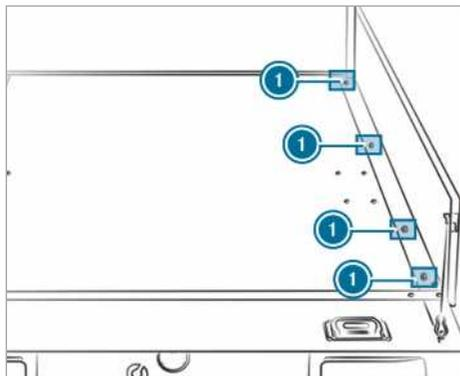

Lashing points (example: platform vehicle)

1 Tie-down eyes

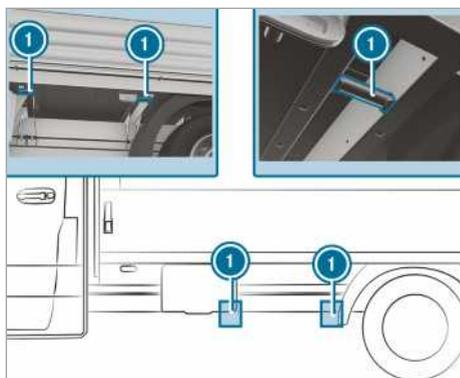

Lashing points (example: platform vehicle)

1 Tie-down eyes

Once you have removed the platform dropsides, you can use the lashing points on the bottom left and right of the crossmember.

Secure loose loads, in particular on the load surface of a platform vehicle, with an approved lashing net or tarpaulin.

Always fasten the lashing net or tarpaulin to all available lashing points. Make sure that the fastening hooks are secured against accidental opening.

If your vehicle is equipped with loading rails in the load compartment floor, you can place lashing rods directly in front of and behind the load. The lashing rods directly absorb the potential shifting forces.

Securing loads on the load compartment floor by lashing them down is only recommended for

lightweight loads. Lay anti-slip mats underneath the load to secure the load additionally.

Fitting and removing tie-down eyes

- ▶ **To fit:** slide the tie-down eye through a recess in the loading rail close to the load until locking mechanism engages in the recess.
- ⓘ When you pull locking mechanism up and out of the recess, the tie-down eye is able to move within the loading rail. Make sure that locking mechanism is always engaged in a recess.
- ▶ Check the tie-down eye for firm seating.
- ▶ **To remove:** pull locking mechanism up and pull the tie-down eye towards the locking mechanism and out of the loading rail through a recess.

Carrier systems

Information about the roof rack

⚠ WARNING Risk of injury due to the maximum roof load being exceeded

When you place a load on the roof as well as all outer and inner attachments, the vehicle's centre of gravity will rise and the familiar driving characteristics as well as the steering and braking characteristics will change. When driving around bends, the vehicle will tilt more heavily and may react more sluggishly to steering movements.

If you exceed the maximum roof load, the driving characteristics, as well as the steering and braking, will be greatly impaired.

- ▶ Never exceed the maximum roof load and adjust your driving style.

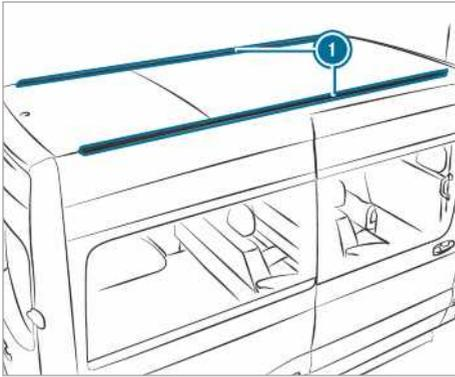

① Mounting rails

Information about the maximum roof load can be found in the "Technical data" section (→ page 358).

Observe the following points for assembling roof racks:

- Tighten the roof rack's screws to a torque of 8 Nm – 10 Nm in the designated grooved plates.
- The tightened screws should not touch the rails.
- Ensure that the grooved plates are not located in the areas around the plastic caps.
- The grooved plates must have the right cross-section.
- The insides of the mounting rails must be free of dirt.
- Re-tighten the screws uniformly after around 500 km.

Mercedes-Benz recommends that you use only roof racks that have been tested and approved for Mercedes-Benz. These help to prevent vehicle damage.

If you want to retrofit the mounting rails, have them installed at a qualified specialist workshop. Otherwise, you could damage the vehicle.

If your vehicle is fitted with mounting rails on the roof, you can install a roof rack on the roof. Special fasteners (sliding blocks) are available as accessories for this purpose.

These fasteners are available from any Mercedes-Benz Service Centre.

Ladder rack

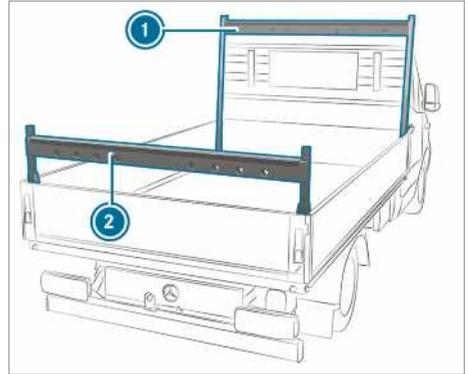

Ladder rack on a platform vehicle (example)

- ① Front ladder rack
- ② Rear ladder rack

Comply with the important safety instructions in the section entitled "Notes on loading" (→ page 77).

Information about the maximum load for ladder racks can be found in the section entitled "Technical data" (→ page 359).

Using the interior roof carrier system

⚠ WARNING Risk of injury due to unsecured loads

When you secure or loosen a load, the load may fall down and injure vehicle occupants.

- ▶ When securing or loosening a load, do not stand under the load.

! NOTE Risk of damage to the belt straps and slider

Excessive point loading on the belt straps and sliders may cause the belt straps to tear or cause the sliders to break off from the rack rail.

- ▶ Distribute the load evenly. When doing so, ensure that the overall centre of gravity of the load is always as close to the centre as possible and between the roof rails and between the rack rails.

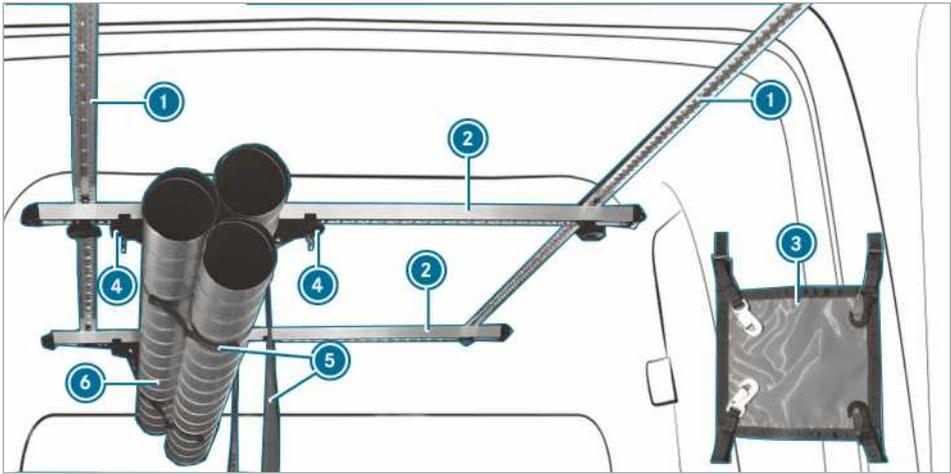

You can use the interior roof rack system to secure loads. It is also suitable for securing long loads.

i The interior roof rack system may be subjected to a maximum load of 50 kg.

The interior roof rack system consists of the following components:

- Roof rails **1** are attached to the roof of the vehicle.
- Rack rails **2** are screwed onto the roof rails and can be moved.
- Rack rail **2** is equipped with slider pair **4**. Slider pair **4** with attached belt strap **5** can be moved. Load **6** is stowed by placing and lashing it in belt strap **5**.
- The load has to be secured in the direction of travel and in the opposite direction to the direction of travel using two head lashings **3**.

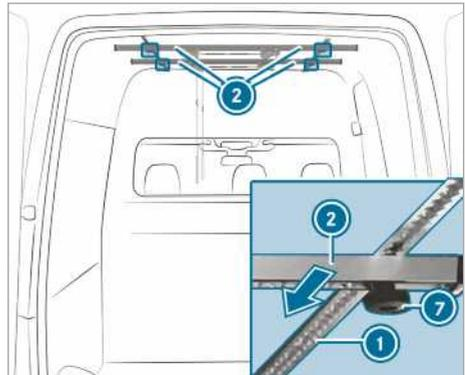

- ▶ **To move the rack rails:** unscrew star knobs **7** anti-clockwise until they are slightly loose.
- ▶ Slide rack rail **2** along roof rail **1** to the desired position.
- ▶ Screw star knobs **7** tight clockwise.
- ▶ Check that the rack rail is seated securely.

Moving the sliders

⚠ WARNING Risk of injury due to inadequately secured loads

If the slider of the interior roof rack system is not engaged properly, the load may come loose, fall down and injure people, for instance when they enter or load and unload the load compartment.

- ▶ Always engage the slider properly.

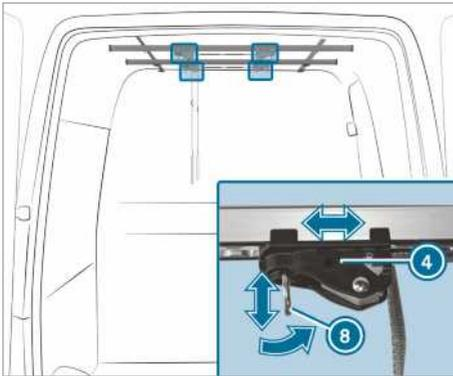

- ▶ i Ring 8 of slider 4 must always be at an angle of 90° to rack rail 2, so that slider 4 is engaged properly.

▶ **When the ring of the slider is at an angle of 90° to the rack rail:** pull ring 8 of slider 4 down and simultaneously move slider 4 to the desired position.

- ▶ Release ring 8 at the desired position.
- ▶ Move slider 4 slightly further along on rack rail 2 until slider 4 engages automatically.

▶ **When the ring of the slider is parallel to the rack rail:** move slider 4 to the desired position.

- ▶ Position ring 8 of slider 4 at an angle of 90° to rack rail 2.
- ▶ Slider 4 is engaged.

Adjusting the belt strap

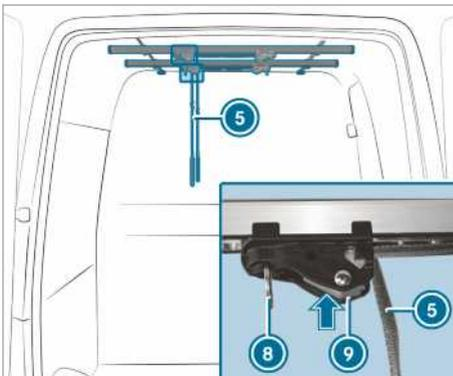

- ▶ Press and hold the locking mechanism on slider 9.
- ▶ Pull or release belt strap 5.

- ▶ Release the locking mechanism on slider 9.
- ▶ i When securing or loosening a load, be sure to not stand under the load.

Securing and loosening the load

- ▶ **To secure the load:** place the load in the belt straps of the rack rails.
- ▶ Fasten the load flush with the partition.
- ▶ Secure belt strap 5.
- ▶ Check that the load is seated securely.
- ▶ **To loosen the load:** press and hold the locking mechanism on slider 9.
- ▶ Pull ring 8 of the slider down and simultaneously move the slider away from the load.
- ▶ Loosen belt strap 5 and at the same time make sure that the load does not fall out of the belt straps.
- ▶ Remove the load from the belt straps.

Fitting lashing eyelets



- ▶ Turn the ring of lashing eyelet 11 until it is parallel to the longitudinal axis of lashing eyelet 12.
- ▶ Hold lashing eyelet 12 between the index finger and middle finger and place your thumb through the ring of lashing eyelet 11 and onto the central pressure point.
- ▶ Use your thumb to push the locking pin down as far as it will go.
- ▶ Push lashing eyelet 12 near the load through the notches on rack rail 2 and move it approximately 12 mm.
- ▶ Remove your thumb from the pressure point and slide lashing eyelet 12 until it engages.
- ▶ Turn the ring of lashing eyelet 11 until it is perpendicular to the longitudinal axis of lashing eyelet 12.
- ▶ Lashing eyelet 12 is secured.

Removing lashing eyelets

- ▶ Turn the ring of lashing eyelet ⑪ until it is parallel to the longitudinal axis of lashing eyelet ⑫.
- ▶ Grip lashing eyelet ⑫ as described above under fitting and use your thumb to push the locking pin down as far as it will go.
- ▶ Slide lashing eyelet ⑫ and pull it down and out through the notches of rack rail ②.

Attaching the head lashing

⚠ WARNING Risk of injury due to incorrectly secured loads

When the hooks on the head lashing are attached to the rings of the sliders, the sliders could come loose. The load may come loose, fall down and injure people, for instance when they enter or load and unload the load compartment.

- ▶ Only attach the hooks on the head lashing to the rings of the lashing eyelets.

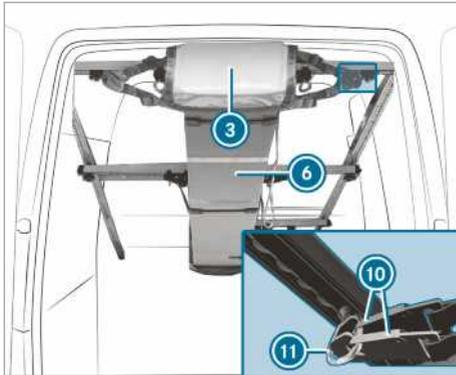

- ⓘ The hooks on head lashing ③ may only be attached to the rings of lashing eyelets ⑪.
- ▶ Check that the load is seated securely.
- ▶ **To attach the head lashing:** tension head lashing ③ at both ends of load ⑥ and attach two hooks ⑩ of the head lashing to the rings of lashing eyelets ⑪.

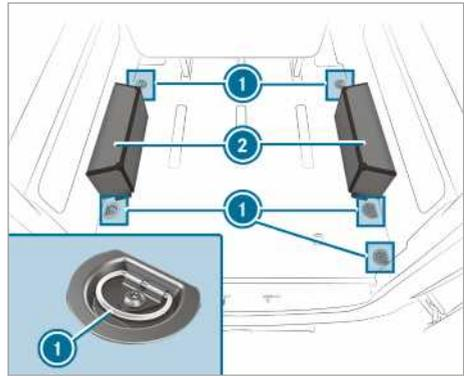

- ▶ Place the objects on wheel arch ② and lash them using tie-down eyes ① (→ page 272).
- ⓘ A wheel arch may be subjected to a load of 150 kg.

Placing a load on the wheel arch

Comply with the important safety notes under "Notes on loading" (→ page 77).

ASSYST PLUS service interval display

Function of the ASSYST PLUS service interval display

The ASSYST PLUS service interval display on the instrument display provides information on the remaining time or distance before the next service due date.

You can hide this service message by using the back button on the left-hand side of the steering wheel.

You can obtain further information concerning the servicing of your vehicle from a qualified specialist workshop, e.g. a Mercedes-Benz Service Centre.

Displaying the service due date

On-board computer:

→ Service ► ASSYST PLUS

The next service due date is displayed.

► **To exit the display:** press the back button on the left-hand side of the steering wheel.

Bear in mind the following related topic:

- Operating the on-board computer(→ page 181)

Carrying out maintenance work regularly

! **NOTE** Premature wear through failure to observe service due dates

Service work which is not carried out at the right time or incompletely can lead to increased wear and damage to the vehicle.

- Always observe the prescribed service intervals.
- Always have the prescribed service work carried out at a qualified specialist workshop.

Special service requirements

The prescribed service interval is based on normal vehicle use. Maintenance work will need to be performed more often than prescribed if the vehicle is operated under arduous conditions or increased loads.

Examples of arduous operating conditions:

- regular city driving with frequent intermediate stops

- mainly short-distance driving
- frequent operation in mountainous terrain or on poor road surfaces
- when the engine is often left idling for long periods
- operation in particularly dusty conditions and/or if air-recirculation mode is frequently used

In these or similar operating conditions, have the interior air filter, engine air cleaner, engine oil and oil filter etc. changed more frequently. If the vehicle is subjected to higher loads, the tyres must be checked more frequently. Further information can be obtained at a qualified specialist workshop.

Battery disconnection periods

The ASSYST PLUS service interval display can only calculate the service due date when the battery is connected.

► Note down the service due date displayed on the instrument display before disconnecting the battery (→ page 278).

Engine compartment

Opening and closing the bonnet

! **WARNING** Risk of accident due to driving with the engine bonnet unlocked

An unlocked engine bonnet may open up when the vehicle is in motion and block your view.

- Never unlock the engine bonnet when driving.
- Before every trip, ensure that the engine bonnet is locked.

! **WARNING** Danger of burns when opening the bonnet

If you open the engine bonnet when the engine has overheated or during a fire in the engine compartment, you could come into contact with hot gases or other escaping operating fluids.

- Before opening the bonnet, allow the engine to cool down.

- ▶ In the event of a fire in the engine compartment, keep the engine bonnet closed and call the fire service.

⚠ WARNING Risk of injury due to moving parts

Certain components in the engine compartment may continue to move or suddenly move again even after the ignition has been switched off, e.g. the cooler fan.

Make sure of the following before performing tasks in the engine compartment:

- ▶ Switch the ignition off.
- ▶ Never touch the danger zone surrounding moving component parts, e.g. the rotation area of the fan.
- ▶ Remove jewellery and watches.
- ▶ Keep items of clothing and hair away from moving parts.

⚠ WARNING Risk of injury from touching component parts under voltage

The ignition system and the fuel injection system work under high voltage. If you touch component parts which are under voltage, you could receive an electric shock.

- ▶ Never touch components of the ignition system or the fuel injection system when the ignition is switched on.

Live components of the fuel injection system include the injectors, for example.

Live components of the ignition system include the following:

- ignition coils
- spark plug connectors
- diagnostic socket

⚠ WARNING Risk of burns from hot component parts in the engine compartment

Certain components in the engine compartment can be very hot, e.g. the engine, the radiator and parts of the exhaust system.

- ▶ Allow the engine to cool down and only touch component parts described in the following.

If you have to carry out any work in the engine compartment, touch only the following components:

- bonnet
- engine oil filler opening cap
- washer fluid reservoir cap
- coolant expansion reservoir cap

⚠ WARNING Risk of injury from using the windscreen wipers while the engine bonnet is open

When the engine bonnet is open, and the windscreen wipers are set in motion, you can be trapped by the wiper linkage.

- ▶ Always switch off the windscreen wipers and ignition before opening the engine bonnet.

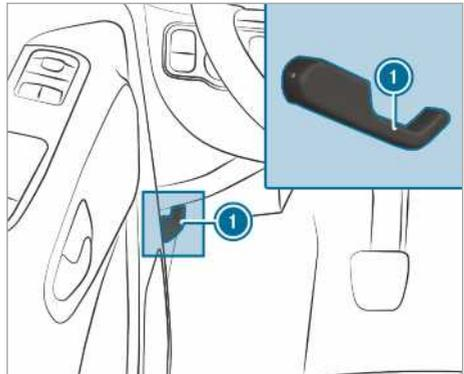

- ▶ Park the vehicle in a safe location and on a level surface if possible.
- ▶ Switch off the engine.
- ▶ Secure the vehicle against rolling away.

⚠ WARNING Risk of injury when the bonnet is opened

When you open the bonnet, it may suddenly drop into the end position.

There is a risk of injury for anyone in the engine bonnet's range of movement.

- ▶ Before releasing the bonnet, ensure that the support is firmly seated in the holder.
- ▶ Open the bonnet only when there is no one in the bonnet's range of movement.

- ▶ **To open:** pull the handle ① to release the bonnet.
- ▶ Reach into the gap and push the bonnet catch handle upwards.
- ▶ Open the bonnet and hold it up.

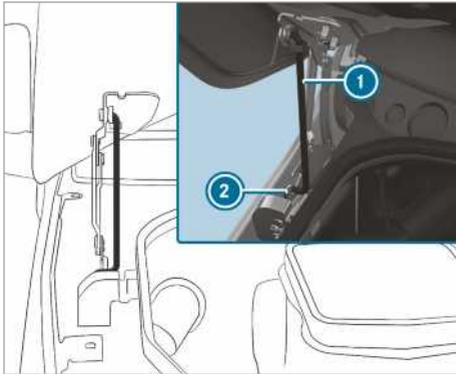

- ▶ Take the support ① from the bracket on the bonnet and pull it downwards.
- ▶ Insert the support into the bracket below ②.

⚠ WARNING Risk of fire due to flammable material in the engine compartment or the exhaust system

Cloths or other flammable materials left in the engine compartment by mistake could ignite upon coming into contact with hot sections of the engine or exhaust system.

- ▶ Ensure that there are no flammable external materials in the engine compartment or on the exhaust system after maintenance work has been conducted.

⚠ WARNING Risk of accident and injury when opening and closing the engine bonnet

When opening or closing the engine bonnet, it may suddenly drop into the end position.

There is a risk of injury for anyone in the engine bonnet's range of movement.

- ▶ Only open or close the engine bonnet when there are no persons in the engine bonnet's range of movement.

! **NOTE** Damage to the bonnet

Pushing the bonnet closed with your hands could damage it.

- ▶ To close the bonnet, let it drop from the specified height.

- ▶ **To close:** lift the bonnet slightly.
- ▶ Move the support ① to the bracket on the bonnet and apply light pressure to engage it.
- ▶ Lower the bonnet and let it drop from a height of approximately 15 cm.
- ▶ If it is still possible to lift the bonnet a little, open the bonnet again and let it drop from a height of approximately 20 cm until it engages correctly.

Engine oil

Checking the engine oil level with an on-board computer

Requirements:

- The vehicle is level during the measuring process.
- The bonnet is not open.
- Depending on the driving profile, the oil level can be displayed only after a driving time of up to 30 minutes and only when the ignition is switched on.

On-board computer:

↪ **Service** ▶▶ **Engine oil level:**

You will see one of the following messages in the multifunction display:

- ▶ **Engine oil level Measuring now:** measurement of the oil level not yet possible. Repeat the query after driving a maximum of 30 minutes.
- ▶ **Engine oil level OK** and the bar to display the oil level in the multifunction display is green and lies between "MIN" and "MAX": the oil level is OK.
- ▶ **Engine oil level Warm up the engine:** warm up the engine to operating temperature.
- ▶ **Engine oil level Correct measurement only if vehicle is on level ground:** park the vehicle on an even surface.
- ▶ **Engine oil level Add 1,0 l** and the bar to display the oil level in the multifunction display is orange and lies below "MIN": add 1 l of engine oil.

- ▶ **Reduce engine oil level** and the bar displaying the oil level in the multifunction display is orange and lies above "MAX": drain off excess engine oil.
Visit a qualified specialist workshop.
 - ▶ **For engine oil level switch on ignition**: switch on the ignition in order to check the engine oil level.
 - ▶ **Engine oil level System inoperative**: sensor is defective or not connected. Visit a qualified specialist workshop.
 - ▶ **Engine oil level currently inoperative**: close the bonnet.
- i** Vehicles with cold oil level displays: the oil level is automatically displayed on the multifunction display after the vehicle has been non-operational for an extended period. If it is not possible to measure the engine oil level, a relevant message will appear.

Topping up the engine oil

⚠ WARNING Risk of burns from hot component parts in the engine compartment

Certain components in the engine compartment can be very hot, e.g. the engine, the radiator and parts of the exhaust system.

- ▶ Allow the engine to cool down and only touch component parts described in the following.

⚠ WARNING Danger of burns when opening the bonnet

If you open the engine bonnet when the engine has overheated or during a fire in the engine compartment, you could come into contact with hot gases or other escaping operating fluids.

- ▶ Before opening the bonnet, allow the engine to cool down.
- ▶ In the event of a fire in the engine compartment, keep the engine bonnet closed and call the fire service.

If you have to carry out any work in the engine compartment, touch only the following components:

- bonnet
- engine oil filler opening cap
- washer fluid reservoir cap
- coolant expansion reservoir cap

⚠ WARNING Risk of fire and injury from engine oil

If engine oil comes into contact with hot component parts in the engine compartment, it may ignite.

- ▶ Make sure that no engine oil is spilled next to the filler opening.
- ▶ Allow the engine to cool off and thoroughly clean the engine oil from component parts before starting the vehicle.

! NOTE Engine damage due to incorrect oil filter, incorrect oil or additive

- ▶ Do not use engine oil or an oil filter with specifications deviating from those required for the prescribed service intervals.

Mercedes-Benz recommends using original or tested replacement and service parts.

- ▶ Do not change the engine oil or oil filter in order to set change intervals longer than those prescribed.
- ▶ Do not use any additive.
- ▶ Follow the instructions on the service interval display for changing the engine oil.

! NOTE Damage caused by topping up too much engine oil

Too much engine oil can damage the engine or the catalytic converter.

- ▶ Have excess engine oil removed at a qualified specialist workshop.

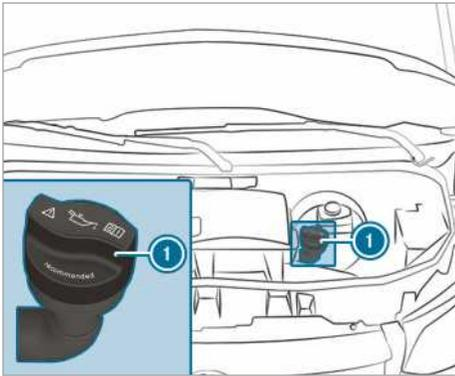

Engine OM651

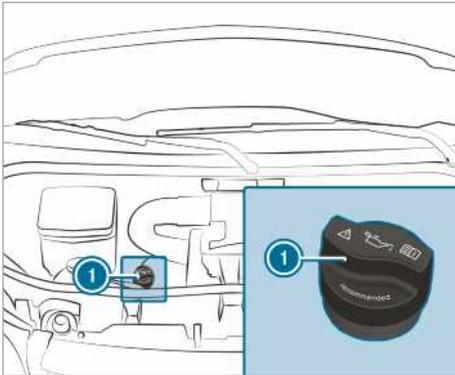

Engine OM642

- ▶ Turn cap ① anti-clockwise and remove it.
- ▶ Top up the engine oil.
- ▶ Replace cap ① and turn it clockwise until it engages.
- ▶ Check the oil level again (→ page 280).

Checking the coolant level

⚠ WARNING Risk of burns from hot component parts in the engine compartment

Certain components in the engine compartment can be very hot, e.g. the engine, the radiator and parts of the exhaust system.

- ▶ Allow the engine to cool down and only touch component parts described in the following.

If you have to carry out any work in the engine compartment, touch only the following components:

- bonnet
- engine oil filler opening cap
- washer fluid reservoir cap
- coolant expansion reservoir cap

⚠ WARNING Danger of burns when opening the bonnet

If you open the engine bonnet when the engine has overheated or during a fire in the engine compartment, you could come into contact with hot gases or other escaping operating fluids.

- ▶ Before opening the bonnet, allow the engine to cool down.
- ▶ In the event of a fire in the engine compartment, keep the engine bonnet closed and call the fire service.

⚠ WARNING Risk of scalding from hot coolant

The engine cooling system is pressurised, particularly when the engine is warm. If you open the cap, you could be scalded by hot coolant spraying out.

- ▶ Let the engine cool down before opening the cap.
- ▶ When opening the cap, wear protective gloves and safety glasses.
- ▶ Open the cap slowly to release pressure.

Allow the engine and the engine cooling system to cool down before checking the coolant level or refilling coolant.

! **NOTE** Paintwork damage due to coolant

If coolant gets on painted surfaces, the paintwork can be damaged.

- ▶ Add coolant carefully.
- ▶ Remove spilled coolant.

Checking the coolant level

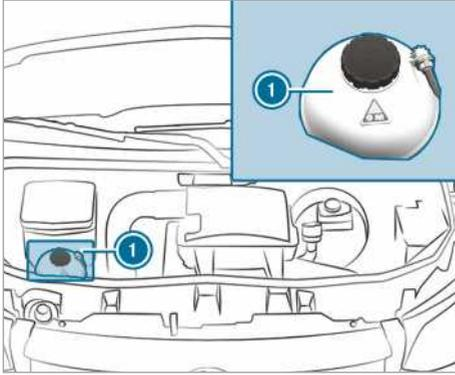

Example: coolant expansion reservoir

- ▶ Park the vehicle on an even surface.
- ▶ Open the bonnet (→ page 278).
- ▶ Slowly turn the coolant expansion reservoir cap ① half a turn anti-clockwise and allow excess pressure to escape.
- ▶ Turn coolant expansion reservoir cap ① further and remove it.
- ▶ Check the coolant level.
There is enough coolant in coolant expansion reservoir if the coolant reaches the MAX mark.

Topping up the coolant

- ▶ Refill the coolant to the MAX mark on the coolant expansion reservoir.

Only use coolant approved by Mercedes-Benz to avoid damaging the engine cooling system.

- ▶ Replace coolant expansion reservoir cap ① and tighten in a clockwise direction.
- ▶ Start the engine.
- ▶ After approximately five minutes, switch off the engine again and allow it to cool down.
- ▶ Check the coolant level again and top up the coolant if necessary.

① Observe additional coolant information (→ page 355).

Filling up the windscreen washer system

⚠ WARNING Risk of burns from hot component parts in the engine compartment

Certain components in the engine compartment can be very hot, e.g. the engine, the radiator and parts of the exhaust system.

- ▶ Allow the engine to cool down and only touch component parts described in the following.

If you have to carry out any work in the engine compartment, touch only the following components:

- bonnet
- engine oil filler opening cap
- washer fluid reservoir cap
- coolant expansion reservoir cap

⚠ WARNING Danger of burns when opening the bonnet

If you open the engine bonnet when the engine has overheated or during a fire in the engine compartment, you could come into contact with hot gases or other escaping operating fluids.

- ▶ Before opening the bonnet, allow the engine to cool down.
- ▶ In the event of a fire in the engine compartment, keep the engine bonnet closed and call the fire service.

⚠ WARNING - Risk of fire and injury due to windscreen washer concentrate

Windscreen washer concentrate is highly flammable. It could ignite if it comes into contact with hot engine component parts or the exhaust system.

- ▶ Make sure that no windscreen washer concentrate spills out next to the filler opening.

Topping up the washer fluid

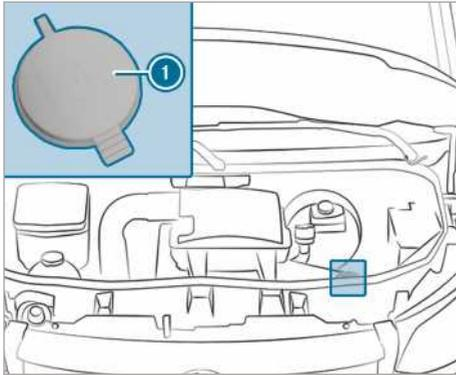

Washer fluid reservoir (example)

- ▶ Pre-mix the washer fluid in the correct mixing ratio in a container.
 - ▶ Park the vehicle on a level surface and secure it against rolling away (→ page 146).
 - ▶ Open the bonnet (→ page 278).
 - ▶ Pull the cap of the washer fluid container ① upwards by the strap.
 - ▶ Pour in the pre-mixed washer fluid.
 - ▶ Press the cap ① onto the filler opening until it audibly engages.
 - ▶ Close the bonnet (→ page 278).
- ① Comply with the further information about windscreen washer fluid (→ page 356)

Cleaning the water drain valve of the air intake box

- ⚠ **WARNING** Risk of injury due to moving parts

Certain components in the engine compartment may continue to move or suddenly move again even after the ignition has been switched off, e.g. the cooler fan.

Make sure of the following before performing tasks in the engine compartment:

- ▶ Switch the ignition off.
- ▶ Never touch the danger zone surrounding moving component parts, e.g. the rotation area of the fan.
- ▶ Remove jewellery and watches.

- ▶ Keep items of clothing and hair away from moving parts.

- ⚠ **WARNING** Risk of burns from hot component parts in the engine compartment

Certain components in the engine compartment can be very hot, e.g. the engine, the radiator and parts of the exhaust system.

- ▶ Allow the engine to cool down and only touch component parts described in the following.

If you have to carry out any work in the engine compartment, touch only the following components:

- bonnet
- engine oil filler opening cap
- washer fluid reservoir cap
- coolant expansion reservoir cap

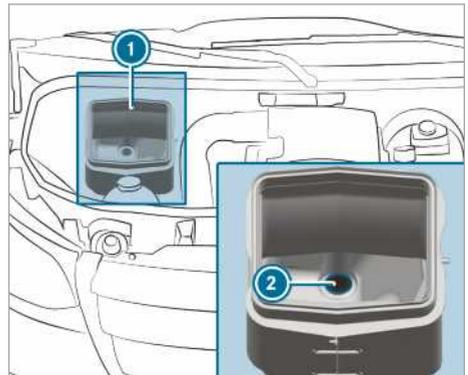

- ▶ Open the bonnet (→ page 278).
- ▶ Remove dirt from the water drain valve ② of the air intake box ①.

Draining the fuel filter

- ⚠ **WARNING** Danger of fire and explosion due to fuel

Fuels are highly flammable.

- ▶ It is essential to avoid fire, naked flames, smoking and creating sparks.
- ▶ Before filling up, switch off the engine, and, if applicable, the auxiliary heating.

⚠ WARNING Risk of fire and explosion due to fuel

Fuels are highly flammable. There is a risk of fire and explosion due to contact with hot component parts.

- ▶ Allow the engine and the exhaust system to cool down.

! NOTE Engine damage due to delayed drainage of the fuel filter

Vehicles with a diesel engine: delayed drainage of the fuel filter can lead to engine damage.

If the indicator lamp  lights up, drain the fuel filter immediately.

🔥 ENVIRONMENTAL NOTE Environmental pollution due to disposal in a non-environmentally-friendly manner

- ▶ Dispose of the water/fuel mixture in an environmentally-friendly manner.

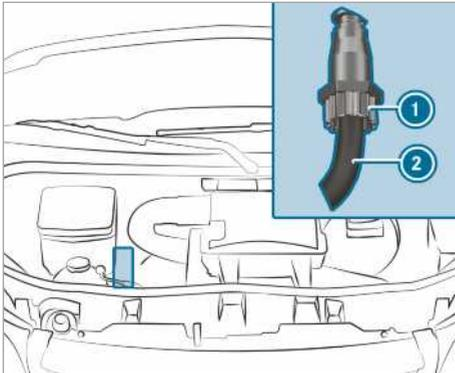

Motor OM642

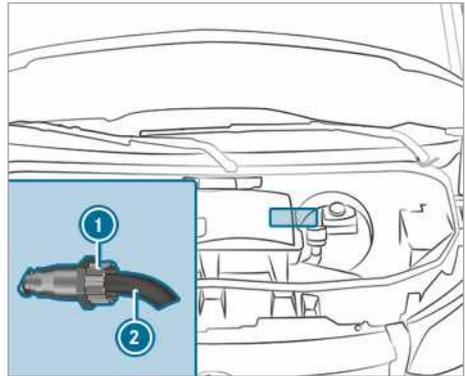

OM651 front wheel drive

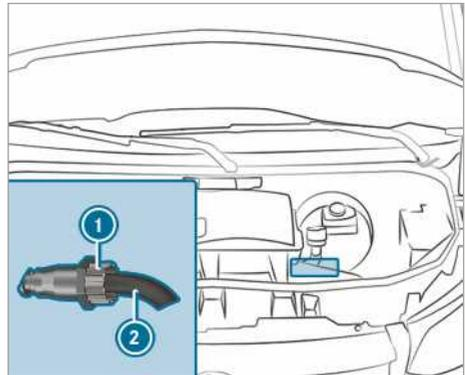

OM651 rear wheel drive

- ▶ Park the vehicle in a safe location and secure it against rolling away.
- ▶ Switch off the auxiliary heating (→ page 108).
- ▶ Switch off the engine.
- ▶ Open the bonnet (→ page 278).
- ▶ Place a suitable collector beneath drain hose ②.
- ▶ Switch on the ignition.
- ▶ Open drain screw ① until the water/fuel mixture emerges from drain hose ②.
- ▶ Close drain screw ① as soon as around 0.2 litre of the water/fuel mixture has been collected.
After 30 seconds, the electrical fuel pump automatically stops the discharge of the water/fuel mixture.
- ▶ After draining, switch off the ignition.

- ▶ Dispose of the collected water/fuel mixture in an environmentally responsible manner, e.g. at a qualified specialist workshop.
- ▶ Check that drain screw ① has been closed. If the engine is running while drain screw ① is open, you will lose fuel through drain hose ②.
- ▶ Close the bonnet (→ page 278).
- ▶  **The indicator lamp does not go out after draining:** drain the fuel filter again.
- ▶  **The indicator lamp does not go out after the second draining:** consult a qualified specialist workshop.

Mercedes-Benz recommends that you have the fuel filter drained at a qualified specialist workshop.

Cleaning and care

Notes on washing the vehicle in an automatic car wash

▲ WARNING Risk of an accident due to reduced braking power after washing the vehicle

Braking efficiency is reduced after washing the vehicle.

- ▶ After the vehicle has been washed, brake carefully while paying attention to the traffic conditions until braking power has been fully restored.

Make sure that the automatic car wash is suitable for the size of the vehicle.

Before washing the vehicle in an automatic car wash, fold in the outside mirrors and remove any additional aerials. Otherwise, the outside mirrors, aerial or the vehicle itself could be damaged.

Make sure any additional aerials are refitted and that the outside mirrors are fully folded out again when you leave the automatic car wash.

To avoid damage to your vehicle, observe the following before using an automatic car wash:

- the side windows and the sliding window are completely closed.
- the blower for ventilation and heating is switched off.
- the windscreen wiper switch is in position 0.

If the vehicle is very dirty, wash off excess dirt before cleaning the vehicle in an automatic car wash.

- ① Removing the wax from the windscreen and the wiper rubbers after washing the vehicle, will help avoid smearing and reduce wiper noise.

Notes on use of a high-pressure cleaner

▲ WARNING Risk of an accident when using high-pressure cleaners with circular jet nozzles

The water jet of a circular jet nozzle (dirt grinder) can cause externally invisible damage to the tyres or chassis parts.

Components damaged in this way may unexpectedly fail.

- ▶ Do not use high-pressure cleaners with circular jet nozzles to clean the vehicle.
- ▶ Have damaged tyres or chassis parts replaced immediately.

Never use a high-pressure cleaner in the vehicle interior. The pressurised water created by the high-pressure cleaner and the associated spray could cause considerable damage to the vehicle.

To avoid damage to your vehicle, observe the following when using a high-pressure cleaner:

- maintain a minimum distance of 30 cm to the vehicle when using 25° flat-spray nozzles and dirt grinders or 70 cm when using round-spray nozzles and observe the information in the equipment manufacturer's operating instructions.
- do not direct the nozzle of the high-pressure cleaner directly at sensitive parts such as tyres, slits, electrical components, batteries, light bulbs and ventilation slits.
- maintain a minimum distance of 50 cm for a reversing camera.

Washing the vehicle by hand

Observe the legal requirements, for example in many countries washing by hand is only allowed at specially designated wash bays. In this case, make sure that a specially designated wash bay is used for washing by hand.

- ▶ Use a mild cleaning agent, e.g. car shampoo.

- ▶ Wash the vehicle with lukewarm water and a soft car sponge. When doing so, do not expose the vehicle to direct sunlight.
- ▶ Carefully spray the vehicle with water and dry off with a leather cloth. Be careful not to point the water jet directly towards the air inlet grilles. The blower should be switched off while doing so.
- ▶ Do not let the cleaning agent dry on the paintwork.

At the onset of winter, remove all traces of road salt deposits carefully and as soon as possible.

Observe the following notes:

	Notes on cleaning and care	Avoiding paintwork damage
Paint	<ul style="list-style-type: none"> • Insect remains: soak with insect remover and then wash off. • Bird droppings: soak with water and then wash off. • Remove coolant, tree resin, oils, fuels and greases: rub gently with a cloth soaked in petroleum ether or lighter fluid. • Brake fluid: wash off with water. • Tar stains: use tar remover. • Wax: use a silicone remover. 	<ul style="list-style-type: none"> • Do not affix stickers, films or similar. • Remove dirt as soon as possible.
Matt finish	<ul style="list-style-type: none"> • Only use care products approved for Mercedes-Benz. 	<ul style="list-style-type: none"> • Do not polish the vehicle and light-alloy wheels. • Do not use a wash program that ends with a hot wax treatment in automatic car washes. • Do not use paint cleaners, buffing or polishing products, or gloss preservers, e.g. wax. • Have paint repairs carried out in a qualified specialist workshop only.

Notes on the care of vehicle parts

⚠ WARNING Risk of entrapment if the windscreen wipers are switched on while the windscreen is being cleaned

If the windscreen wipers are set in motion while you are cleaning the windscreen or wiper blades, you can be trapped by the wiper arm.

Notes on care of paint and matt finish

! **NOTE** Paintwork damage and corrosion due to inadequate care

Failure to promptly and thoroughly remove dirt from bird droppings or other residue could result in paintwork damage and corrosion at a later date.

- ▶ Clean dirt off paint and matt finish thoroughly and as soon as possible.

- ▶ Always switch off the windscreen wipers and the ignition before cleaning the windscreen or wiper blades.

⚠ WARNING Risk of burning from the tailpipe or tailpipe trim

The tailpipe and tailpipe trim can become very hot. If you come into contact with these car parts, you could burn yourself.

▶ Always be particularly careful when in the vicinity of the tailpipe and tailpipe

trims and supervise children very closely when in this area.

▶ Before any contact, allow the car parts to cool down.

Observe the following notes:

Notes on cleaning and care		Preventing damage to the vehicle
Wheels/rims	Use water and acid-free wheel cleaner.	<ul style="list-style-type: none"> Do not use acidic wheel cleaners to remove brake dust. Otherwise, wheel bolts and brake components may be damaged. To avoid corrosion of brake discs and brakepads, drive for a few minutes after cleaning before parking the vehicle. The brake discs and brakepads warm up and dry out.
Windows	Clean windows inside and outside with a damp cloth and with a cleaning agent recommended for Mercedes-Benz .	Do not use dry cloths or abrasive or solvent-based cleaning agents to clean the inside of windows.
Wiper blades	Carefully clean the folded-away wiper blades with a damp cloth.	Do not clean the wiper blades too often.
Exterior lighting	Clean the lenses with a wet sponge and mild cleaning agent, e.g. car shampoo.	Only use cleaning agents or cloths suitable for plastic lenses.
Sensors	Clean the sensors in the front and rear bumper and in the radiator grille with a soft cloth and car shampoo.	When using a high-pressure cleaner, keep a minimum distance of 30 cm.
Reversing camera and 360° Camera	Use clean water and a soft cloth to clean the camera lens.	Do not use a high-pressure cleaner.
Trailer hitch	<ul style="list-style-type: none"> Remove traces of rust on the ball, e.g. with a wire brush. Remove dirt with a lint-free cloth. After cleaning, lightly oil or grease the ball head. Observe the notes on care in the trailer hitch manufacturer's operating instructions. 	Do not clean the ball neck with a high-pressure cleaner or solvent.
Sliding door	<ul style="list-style-type: none"> Remove foreign objects from the vicinity of the contact plates and contact pins of the sliding door. Clean the contact plates and contact pins with a mild cleaning agent and a soft cloth. 	Do not oil or grease the contact plates and the contact pins.

	Notes on cleaning and care	Preventing damage to the vehicle
Steps	<ul style="list-style-type: none"> • Clean the electrically operated steps and their housing with a high-pressure cleaner. • After cleaning, spray the lateral guides with silicone spray. • Clean the steps in the bumper with a high-pressure cleaner. 	Do not use oil or grease as a lubricant.
Aluminium dropsides	<ul style="list-style-type: none"> • Brush down the aluminium dropsides with water and a neutral or mild alkaline cleaning agent. 	Do not use abrasive cleaning agents to clean the dropsides.

Notes on interior care

⚠ WARNING Risk of injury from plastic parts breaking off after the use of solvent-based care products

Care and cleaning products containing solvents can cause surfaces in the cockpit to become porous.

When the airbags are deployed, plastic parts may break away.

▶ Do not use any care or cleaning products containing solvents to clean the cockpit.

⚠ WARNING Risk of injury or death from bleached seat belts

Bleaching or dyeing seat belts can severely weaken them.

This can, for example, cause seat belts to tear or fail in an accident.

▶ Never bleach or dye seat belts.

⚠ DANGER Risk of fatal injuries from electric shock

You could get an electric shock if you clean the 230 V socket with a wet cloth.

There is a risk of fatal injury.

Omit the area around the 230 V socket when cleaning.

Observe the following notes:

	Notes on cleaning and care	Preventing damage to the vehicle
Seat belts	Clean with lukewarm soapy water.	<ul style="list-style-type: none"> • Do not use chemical cleaning agents. • Do not dry the seat belt by heating above 80 °C or in direct sunlight.
Display	Clean the surface carefully with a microfibre cloth and LCD/TFT display care product.	<ul style="list-style-type: none"> • Switch off the display and let it cool down. • Do not use any other agents.
Plastic trim	<ul style="list-style-type: none"> • Clean with a damp microfibre cloth. • For heavy soiling: use care product recommended for Mercedes-Benz . 	<ul style="list-style-type: none"> • Do not affix stickers, films or similar. • Do not allow to come into contact with cosmetics, insect repellent and sun creams.

	Notes on cleaning and care	Preventing damage to the vehicle
Real wood/ trim elements	<ul style="list-style-type: none"> • Clean with a microfibre cloth. • Black piano-lacquer look: clean with a damp cloth and soapy water. • For heavy soiling: use care product recommended for Mercedes-Benz . 	Do not use solvent-based cleaning agents, polishes or waxes.
Roof lining	Clean with a soft brush or dry shampoo.	
Cloth seat covers	Vacuum up dirt such as crumbs or dust and then use a damp microfibre cloth and a 1% soapsuds solution to clean the entire seat cover. Do not spot-clean. Use cleaning and care products recommended for Mercedes-Benz .	Do not use any oil-based cleaning and care products.
Imitation leather seat covers	Vacuum up dirt such as crumbs or dust and then use a damp cotton cloth and a 1% soapsuds solution to clean the entire seat cover. Do not spot-clean. Use cleaning and care products recommended for Mercedes-Benz .	Do not use a microfibre cloth. Do not use any oil-based cleaning and care products.
Genuine leather seat covers	Regularly vacuum up dirt such as crumbs or dust and then use a damp cotton cloth to clean the entire seat covers. For heavy soiling: use a leather care agent recommended by Mercedes-Benz for aftertreatment.	Do not use a microfibre cloth. Do not use any oil-based cleaning and care products.
Steering wheel and gear or selector lever	Clean with a damp cloth.	
Pedals and floor mats	Clean with a damp cloth.	Do not use any cleaning and care products.
Vehicle interior	Clean with a damp cloth.	<ul style="list-style-type: none"> • Do not use a high-pressure cleaner. • Allow the vehicle interior to dry completely after cleaning. • Do not allow liquids to penetrate into gaps or cavities.
Curtains	The curtains may only be dry cleaned.	Do not wash the curtains.

Emergency

Removing the safety vest

The safety vest is located in the stowage compartment in the driver's door.

- ▶ Remove the safety vest from the stowage compartment.
- ⓘ Safety vests can also be stored in the stowage compartments of the rear doors and the co-driver's door.

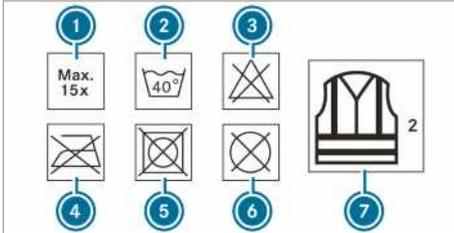

- ① Maximum number of washes
- ② Maximum wash temperature
- ③ Do not bleach
- ④ Do not iron
- ⑤ Do not tumble dry
- ⑥ Do not dry-clean
- ⑦ This is a class 2 vest

The safety vest only fulfils the legally required standards if it is the correct size and is completely closed.

Replace the safety vest:

- if damaged or if the reflex strips are dirty
- if the maximum permitted number of washes is exceeded
- if the safety vest's fluorescence has faded

Warning triangle

Removing the warning triangle

The warning triangle is located in the stowage compartment in the front passenger door.

- ▶ Take warning triangle out of the stowage compartment.

Setting up the warning triangle

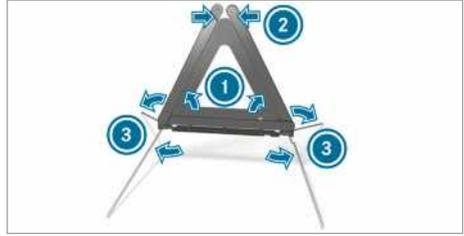

- ▶ Fold side reflectors ① upwards to form a triangle and lock them at the top using the upper press-stud ②.
- ▶ Fold stand ③ down and out to the side.

Removing the first-aid kit

The first-aid kit is located in the stowage compartment in the co-driver's door.

- ▶ Remove the first-aid kit from the stowage compartment.

Removing the warning lamp

The warning lamp is located in the stowage compartment in the co-driver's door.

- ▶ Remove the warning lamp from the stowage compartment.

Removing and stowing fire extinguishers

▲ WARNING Risk of accident due to an incorrectly secured fire extinguisher in the driver's footwell

A fire extinguisher in the driver's footwell may impede pedal travel or block a depressed pedal.

This jeopardises the operating and road safety of the vehicle.

Moreover, the fire extinguisher can be flung around in the driver's footwell and injure the driver or other vehicle occupants.

- ▶ Always store and secure the fire extinguisher in the bracket during the journey.
- ▶ Do not remove the fire extinguisher while driving.

Removing

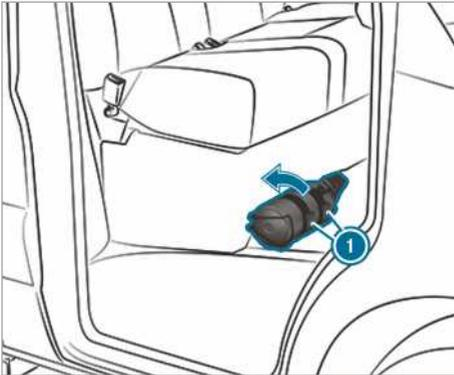

- ▶ Pull the tabs on the bracket of fire extinguisher ① upwards.
- ▶ Remove the fire extinguisher.

Stowing

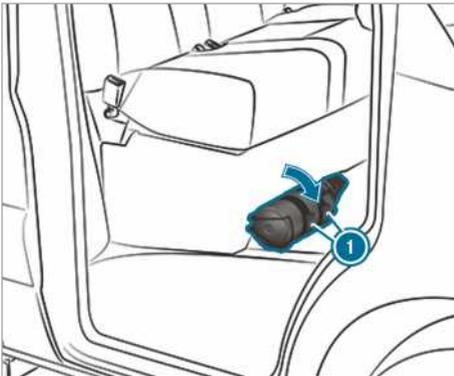

- ▶ Stow the fire extinguisher.
 - ▶ Push the tabs on the bracket of fire extinguisher ① downwards.
- ① In a right-hand-drive vehicle, the fire extinguisher is located on the co-driver's seat on the left when viewed in the direction of travel.

Mercedes-Benz Emergency call system

Information on the Mercedes-Benz emergency call system

The Mercedes-Benz emergency call system only functions in areas where mobile phone coverage is available from the relevant contract partner.

Insufficient network coverage from the relevant contract partner may result in an emergency call not being transmitted.

The ignition must be switched on before an automatic emergency call can be made.

- ① The Mercedes-Benz emergency call system is activated at the factory. Using the Mercedes-Benz emergency call system is free of charge.

Overview of the Mercedes-Benz emergency call system

The Mercedes-Benz emergency call system can help to decisively reduce the time between an accident and the arrival of emergency services at the site of the accident. It helps locate an accident site in places that are difficult to access.

The emergency call can be triggered automatically (→ page 293).

You also have the option of triggering the emergency call manually (→ page 293). Only make emergency calls if you or others are in need of rescue. Do not make an emergency call in the event of a breakdown or a similar situation.

Message in the media display:

SOS NOT READY: the ignition is not on or there is a malfunction with the emergency call system.

This does not necessarily indicate a total failure of the emergency call system. Emergency calls can still be transmitted.

The display refers only to the vehicle and does not take account of the availability of mobile phone networks and the Mercedes-Benz emergency call centre.

The functionality of the emergency call system on the vehicle can be seen when the **SOS NOT READY** display goes out when the ignition is switched on.

During an active emergency call,  appears in the display.

You can find more information on the regional availability of the Mercedes-Benz emergency call system at: http://www.mercedes-benz.com/connect_ecall.

- ① If an emergency call is unavailable due to a technical problem in the vehicle, a message to this effect will appear on the multifunction display of the instrument cluster.

Triggering an automatic Mercedes-Benz emergency call

Requirements:

- The ignition is switched on
- The starter battery has sufficient charge.

The Mercedes-Benz emergency call system automatically triggers an emergency call after activation of the restraint system in the event of an accident, for example airbags or seat belt tensioners.

The emergency call has been made:

- A voice connection is made to the Mercedes-Benz emergency call centre.
- A message with accident data is transmitted to the Mercedes-Benz emergency call centre.
The Mercedes-Benz emergency call centre can transmit the vehicle position data to one of the public emergency services call centres.
- Under certain circumstances data is also transmitted in the voice channel to the Mercedes-Benz emergency call centre.
This allows measures for rescue, recovery or towing to a Mercedes-Benz Service Centre to be initiated quickly.

The SOS button in the overhead control panel flashes until the emergency call is finished.

It is not possible to immediately end an automatic emergency call.

If the Mercedes-Benz emergency call system cannot connect to the Mercedes-Benz emergency call centre, the emergency call is automatically sent to the public emergency services call centre.

If no connection can be made to the public emergency services, a corresponding message appears in the display.

- ▶ Dial the emergency number **112** on your mobile phone.

If an emergency call has been initiated:

- Remain in the vehicle if the road and traffic conditions permit you to do so until a voice connection is established with the emergency call centre service provider.
- Based on the call, the operator decides whether it is necessary to call rescue teams and/or the police to the accident site.
- If no vehicle occupant answers, an ambulance is sent to the vehicle immediately.

Triggering a manual Mercedes-Benz emergency call

- ▶ **Using the SOS button in the overhead control panel:** press the SOS button at least one second long.

- ▶ **Using voice control:** use the LINGUATRONIC Call the Mercedes accident centre voice command (→ page 193).

The emergency call has been made:

- A voice connection is made to the Mercedes-Benz emergency call centre.
- A message with accident data is transmitted to the Mercedes-Benz emergency call centre.

The Mercedes-Benz emergency call centre can transmit the vehicle position data to one of the public emergency services call centres.

- Remain in the vehicle if the road and traffic conditions permit you to do so until a voice connection is established with the emergency call centre service provider.
- Based on the call, the operator decides whether it is necessary to call rescue teams and/or the police to the accident site.
- In certain situations data is also transmitted in the voice channel to the Mercedes-Benz emergency call centre.

This allows measures for rescue, recovery or towing to a Mercedes-Benz Service Centre to be initiated quickly.

If the Mercedes-Benz emergency call system cannot connect to the Mercedes-Benz emergency call centre, the emergency call is automatically sent to the public emergency services call centre.

If no connection can be made to the public emergency services, a corresponding message appears in the media display.

- ▶ Dial the emergency number **112** on your mobile phone.

Ending an unintentional Mercedes-Benz emergency call

- ▶ Select  on the multifunction steering wheel.

Transmitted data Mercedes-Benz emergency call system

In the event of an automatic or manual emergency call, as well as for a **112** emergency call, data is transferred to the Mercedes-Benz emer-

gency call centre or the public emergency services call centre.

The following data is transferred:

- the vehicle's GPS position data
- the last GPS position data on the route (a few 100 metres before the incident)
- direction of travel
- vehicle identification number
- the vehicle drive type
- the estimated number of people in the vehicle
- whether Mercedes PRO connect is available or not
- whether the emergency call was initiated manually or automatically
- time of the accident
- language setting on the multimedia system

For accident clarification purposes, the following measures can be taken up to an hour after the emergency call has been initiated:

- the current vehicle position can be called up
- a voice connection to the vehicle occupants can be established

i For Russia: various functions, e.g. receiving traffic information, cannot be used for up to two hours after sending an emergency call.

Function of the emergency call system self-diagnosis (Russia)

Your car verifies the operability of the emergency call system each time the ignition is ON. In case of system failure, you will be informed with text message on the instrument cluster and with red indicator **SOS NOT READY** on the media display.

Please, make sure, that during 30 seconds after switching ignition ON the red indicator **SOS NOT READY** in the upper right corner of the multimedia display is switched OFF, this means the emergency call system passed diagnostics successfully. If necessary, switch ON the media display, if it was switched OFF before.

Starting/ending ERA-GLONASS test mode (Russia)

Requirements:

- The starter battery has sufficient charge.
- The ignition is switched on.

- The vehicle has been stationary for at least one minute.

- ▶ **To start the test mode:** press and hold the  button on the multifunction steering wheel or the  button on the overhead control panel for at least five seconds. Test mode is started and ended automatically after completion of the speech test.
- ▶ **To stop test mode manually:** switch off the ignition or press the  button on the overhead control panel for at least five seconds. The test mode is ended.

Flat tyre

Notes on flat tyres

▲ WARNING Risk of an accident when driving with a flat tyre

A flat tyre greatly impairs driving characteristics, as well as steering and braking.

- ▶ Do not drive with a flat tyre.
- ▶ Remove the flat tyre and fit the spare wheel or consult a qualified specialist workshop.

In the event of a flat tyre you have the following possibilities depending on your vehicle's equipment:

- **Vehicles with Mercedes PRO connect:** in the event of a flat tyre, you can call breakdown assistance via the breakdown assistance call button in the overhead control panel (→ page 199).
- **All vehicles:** change the wheel (→ page 335).

Battery

Notes on the 12 V battery

▲ WARNING Risk of an accident due to work carried out incorrectly on the battery

Work carried out incorrectly on the battery can, for example, lead to a short circuit. This can lead to function restrictions in safety-relevant systems, e.g. the lighting system, ABS (anti-lock braking system) or ESP® (Electronic Stability Program). The operating safety of your vehicle may be restricted.

You could lose control of the vehicle in the following situations:

- when braking
- in the event of abrupt steering manoeuvres and/or when the vehicle's speed is not adapted to the road conditions
- ▶ In the event of a short circuit or a similar incident, contact a qualified specialist workshop immediately.
- ▶ Do not continue driving.
- ▶ Always have work on the battery carried out at a qualified specialist workshop.

- Further information on ABS (→ page 152)
- Further information on ESP® (→ page 153)

Mercedes-Benz recommends that you have the 12 V battery replaced at a qualified specialist workshop, e.g. at a Mercedes-Benz Service Centre.

Should you want to replace the battery yourself, observe the following information:

- Always replace a faulty battery with a battery which fulfils the vehicle's specific requirements.
- Use detachable parts such as the vent hose, elbow fitting or terminal cover from the battery to be replaced.
- Make sure that the vent hose is always connected to its original opening on the battery side.
Fit the existing or newly supplied stop plugs. Otherwise, gases or battery acid could escape.
- Make sure that the detachable parts are connected in the same way as before.

For safety reasons, Mercedes-Benz recommends that you only use batteries that have been tested and approved for your vehicle by Mercedes-Benz. These batteries provide increased impact protection to prevent vehicle occupants from suffering acid burns should the battery be damaged in an accident.

⚠ WARNING Risk of explosion due to electrostatic charge

Electrostatic charge can cause sparks which may ignite the highly flammable gas mixture in the battery.

- ▶ To discharge any electrostatic charge that may have built up, touch the metal vehicle body before handling the battery.

The highly flammable gas mixture is created while the battery is charging and when jump-starting.

⚠ WARNING Danger of chemical burns from the battery acid

Battery acid is caustic.

- ▶ Avoid contact with the skin, eyes or clothing.
- ▶ Do not lean over the battery.
- ▶ Do not inhale battery gases.
- ▶ Keep children away from the battery.
- ▶ Immediately rinse battery acid off thoroughly with plenty of clean water and seek medical attention immediately.

🔥 ENVIRONMENTAL NOTE Environmental damage due to improper disposal of batteries



Batteries contain pollutants. It is illegal to dispose of them with the household rubbish.



Dispose of batteries in an environmentally responsible manner. Take discharged batteries to a qualified specialist workshop or to a collection point for used batteries.

If the 12 V battery has to be connected, contact a qualified specialist workshop.

Observe the safety notes and protective measures when handling batteries.

Risk of explosion



Fire, naked flames and smoking are prohibited when handling the battery. Avoid creating sparks.



Electrolyte or battery acid is corrosive. Avoid contact with the skin, eyes and clothing. Wear suitable protective clothing, in particular gloves, an apron and a safety mask. Immediately rinse electrolyte acid splashes off with clean water. If necessary, seek medical advice.



Wear eye protection.



Keep children at a safe distance.



Observe these Operating Instructions.

If you do not use the vehicle for a long period or drive short distances regularly:

- connect the battery to a charger recommended for Mercedes-Benz.
- consult a qualified specialist workshop to disconnect the battery

Starting assistance and charging the 12 V battery

- ▶ Always use the jump-start connection point in the engine compartment when charging the battery and jump-starting.

! **NOTE** Damaging the battery through overvoltage

When using a battery charger without a maximum charging voltage, the battery or the vehicle electronics may be damaged.

- ▶ Only use battery chargers with a maximum charging voltage of 14.8 V.

! **WARNING** Risk of explosion from hydrogen gas igniting

A battery generates hydrogen gas during the charging process. If there is a short circuit or sparks start to form, there is a danger of the hydrogen gas igniting.

- ▶ Make sure that the positive terminal of the connected battery does not come into contact with vehicle parts.
- ▶ Never place metal objects or tools on a battery.
- ▶ When connecting and disconnecting the battery, you must observe the described order for the battery clamps.
- ▶ When giving starting assistance, always make sure that you only connect battery terminals with identical polarity.
- ▶ During starting assistance, you must observe the described order for connecting and disconnecting the jump lead.
- ▶ Do not connect or disconnect the battery clamps while the engine is running.

! **WARNING** Risk of explosion during charging process and starting assistance

During the charging process and starting assistance, the battery may release an explosive gas mixture.

- ▶ Avoid fire, naked flames, creating sparks and smoking.
- ▶ Make sure that there is sufficient ventilation during the charging process and during starting assistance.
- ▶ Do not lean over a battery.

! **WARNING** Risk of explosion from a frozen battery

A discharged battery may freeze at temperatures slightly above or below freezing point.

During starting assistance or battery charging, battery gas may be released.

- ▶ Always thaw a frozen battery out first before charging it or performing starting assistance.

If the warning/indicator lamps do not light up in the instrument display around or below freezing point, it is very likely that the discharged battery has frozen.

In this case, observe the following points:

- do not give the vehicle starting assistance or charge the battery
- the service life of a battery that has been thawed may be reduced drastically

- the start-up behaviour may deteriorate, particularly at low temperatures
- it is recommended that you have a thawed battery checked at a qualified specialist workshop

! **NOTE** Damage caused by numerous or extended attempts to start the engine

Numerous or extended attempts to start the engine may damage the catalytic converter due to non-combusted fuel.

- ▶ Avoid numerous and extended attempts to start the engine.

Observe the following points during starting assistance and when charging the battery:

- only use undamaged jump leads/charging cables with a sufficient cross-section and insulated terminal clamps
- non-insulated parts of the terminal clamps must not come into contact with other metal parts while the jump leads/charging cables are connected to the battery/jump-start connection point
- the jump leads/charging cable must not come into contact with any parts which may move when the engine is running
- always make sure that neither you nor the battery is electrostatically charged
- always keep away from fire and naked flames
- do not lean over a battery
- **when charging:** only use a battery charger that has been tested and approved by Mercedes-Benz and read the operating instructions for your charger before charging the battery.

Observe the additional following points during starting assistance:

- starting assistance may only be provided using batteries with a nominal voltage of 12 V
- the vehicles must not touch each other

▶ **Vehicles with a battery main switch:** check whether the battery main switch is switched on (→ page 126).

▶ Secure the vehicle using the parking brake.

▶ **Vehicles with automatic transmission:** shift the transmission to position **[P]**.

▶ **Vehicles with manual transmission:** shift to neutral.

- ▶ Switch off the ignition and all electrical consumers.
- ▶ Open the bonnet (→ page 278).

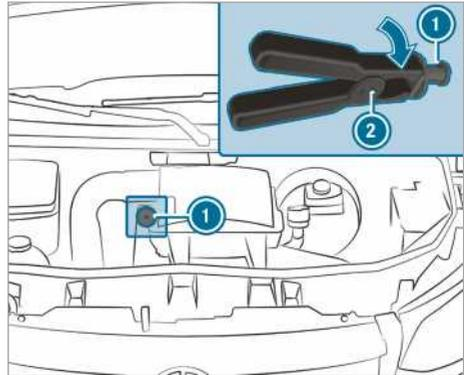

Example: jump-start connection point

i **Right-hand-drive vehicles:** the jump-start connection points may be on the opposite side.

- ▶ Remove the cover from the positive terminal on the donor battery.
- ▶ First, connect the positive terminal clamp of the jump leads/charging cables to the positive terminal of the other vehicle's battery.
- ▶ With positive terminal clamp **2** of the jump lead, slide the red protective cap on jump-start connection point **1** back with a clockwise turn.
- ▶ Connect the positive terminal clamp to the positive terminal of jump-start connection point **1**.
- ▶ **During starting assistance:** start the engine of the donor vehicle and let it run at idle speed.
- ▶ Connect the negative terminal of the donor battery to the earth point of your own vehicle with the jump lead/charging cable. Begin with the donor battery.
- ▶ **During starting assistance:** start the engine on your own vehicle.
- ▶ **When charging:** start the charging process.
- ▶ **During starting assistance:** let the engine run for a few minutes.
- ▶ **During starting assistance:** before disconnecting the jump lead, switch on an electrical

consumer on your own vehicle, e.g. the rear window heater or lighting.

When the starting assistance/charging process is complete:

- ▶ First, remove the jump leads/charging cables from the earth point and negative terminal of the other vehicle's battery, then from the positive terminal of jump-start connection point ① and the positive terminal of the other vehicle's battery. Each time, begin at the contacts on your own vehicle.
The red protective cap springs back to its initial position when positive terminal clamp ② is disconnected from jump-start connection point ①.

Further information can be obtained at a qualified specialist workshop.

Fitting/removing the floor covering (vehicles with rear-wheel drive)

⚠ WARNING Risk of accident due to objects in the driver's footwell

Objects in the driver's footwell may impede pedal travel or block a depressed pedal.

This jeopardises the operating and road safety of the vehicle.

- ▶ Stow all objects in the vehicle securely so that they cannot get into the driver's footwell.
- ▶ Ensure floor mats and carpets cannot slip and provide sufficient room for the pedals.
- ▶ Do not lay multiple floor mats or carpets on top of one another.

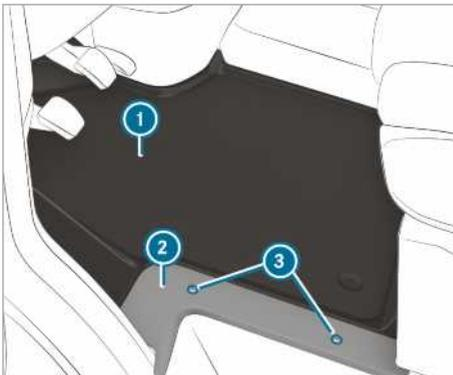

- ▶ Switch off all electrical consumers.
- ▶ **To remove:** unscrew screws ③ and remove trim ②.
- ▶ Remove floor covering ①.
- ▶ **To fit:** insert floor covering ① and align it at the base of the driver's seat and at the door sill.
- ▶ Put trim ② in place and screw screws ③ back in.

Disconnecting the starter battery

! **NOTE** Damage to the electrical assembly

By disconnecting the starter battery before the engine is switched off and the key is removed from the ignition lock, electrical assemblies could be damaged.

- ▶ Switch off the engine and remove the key from the ignition lock. Then, release the battery clamps of the starter battery.
- ▶ Always disconnect the starter battery in the battery case in the left footwell first. Otherwise, electrical assemblies, e.g. the alternator, could be damaged.

! **NOTE** Damage to the vehicle's electronics

If you do not disconnect the battery as described here, the vehicle's electronics could be damaged.

- ▶ Always disconnect the starter battery in following the sequence, and do not reverse the battery terminals under any circumstances. Otherwise, the vehicle's electronics could be damaged.

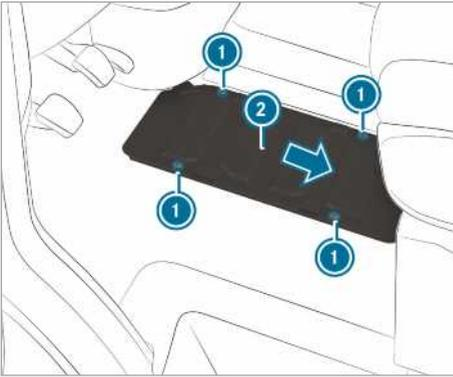

Vehicles with rear wheel drive

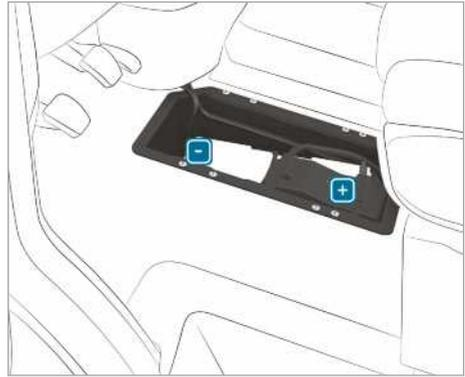

- ▶ First loosen and remove the negative terminal clamp on the battery so that the clamp is no longer in contact with the terminal.
- ▶ Remove the positive terminal clamp cover.
- ▶ Loosen the positive terminal clamp and fold it up to the side, together with the prefuse box.

Removing/fitting the starter battery

Vehicles with rear wheel drive: removing the starter battery

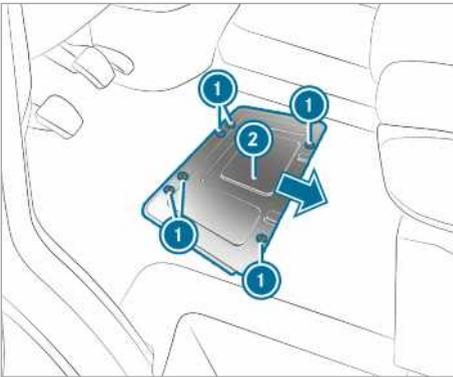

Vehicles with front wheel drive

If the vehicle is expected to be parked up or out of use for over three weeks, disconnect the batteries. This will prevent battery discharge caused by quiescent current consumers.

- ▶ **Vehicles with a battery main switch:** switch off the main switch of the battery .
- ▶ **Vehicles without a battery main switch:** switch off all electrical consumers.
- ▶ Switch off the engine and the power supply.
- ▶ Remove the floor covering (→ page 298).
- ▶ Remove screws ① and slide battery cover ② in the direction of the arrow. The screws must protrude over the larger recesses.
- ▶ Remove battery cover ② upwards.



- ▶ Disconnect the starter battery (→ page 298).
- ▶ Remove breather hose ① with the connector bracket from the connection on the degassing cover.

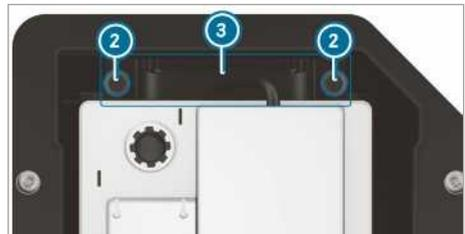

- ▶ Pull out and remove screws ② of bracket ③ upwards.
- ▶ Slide the starter battery from its anchorage in the direction of travel.
- ▶ Fold the bars of the starter battery upwards and remove the starter battery from the battery box.

Vehicles with rear wheel drive: fitting the starter battery

- ▶ When reconnecting the starter battery, observe the safety measures and protection notes (→ page 296).

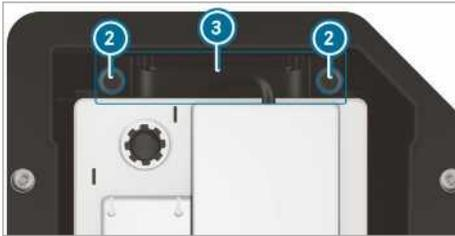

- ▶ Insert the starter battery into the battery box.
- ▶ Fold down the bars of the starter battery.
- ▶ Slide the starter battery into its anchorage in the opposite direction to the direction of travel.
- ▶ Insert bracket ③.
- ▶ Tighten screws ② on bracket ③ which holds the battery in place.



- ▶ Attach breather hose ① with the connector bracket to the connection of the ventilation cover.
- ▶ Reconnect the starter battery (→ page 298).

Mercedes-Benz recommends that you have the starter battery replaced at a qualified specialist workshop, e.g. a Mercedes-Benz Service Centre.

If you want to replace the starter battery yourself, observe the following notes:

- Always replace a defective starter battery with a starter battery which meets the specific requirements of the vehicle.
- Carry over detachable parts such as the vent hose, elbow fitting or terminal cover from the starter battery to be replaced.
- Make sure that the vent hose is always connected to its original opening on the battery side.

Fit the existing or newly supplied stop plugs.

Otherwise, gases or battery acid could escape.

- Make sure that the detachable parts are connected in the same way as before.

Vehicles with front wheel drive: removing the starter battery

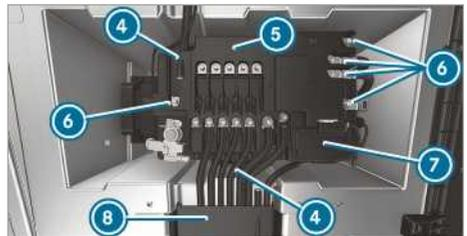

- ▶ Disconnect the starter battery (→ page 298).
- ▶ Open the flap on cable duct ⑧.
- ▶ Open the cover of positive pole ⑦.

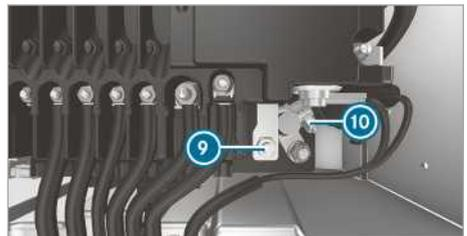

- ▶ Remove nut ⑨ and positive pole ⑩.
- ▶ Unscrew the nuts of wires ⑥, remove the wires and put them aside.
- ▶ Spread out catch tabs ④ on prefuse box ⑤.
- ▶ Lift prefuse box ⑤ off the battery and slide it towards the front right.
- ▶ Fold prefuse box ⑤ upwards and to the rear.



- ▶ Remove breather hose ① with the connector bracket from the connection on the degassing cover.

- ▶ Insert bracket ③.
- ▶ Tighten screws ② on bracket ③ which holds the battery in place.

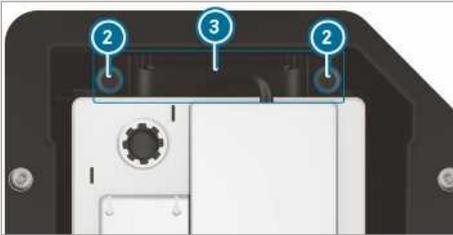

- ▶ Unscrew bolts ② of bracket ③ and pull the bracket out upwards.
- ▶ Slide the starter battery from its anchorage across the direction of travel.
- ▶ Fold the bars of the starter battery upwards and lift the starter battery out of the battery box.

- ▶ Attach breather hose ① with the connector bracket to the connection of the ventilation cover.
- ▶ Place the prefuse box on the battery.

Vehicles with front wheel drive: fitting the starter battery

- ▶ When reconnecting the starter battery, observe the safety measures and protection notes (→ page 296).
- ▶ Insert the starter battery into the battery box.
- ⓘ Take care that no wires are trapped.
- ▶ Fold down the bars of the starter battery.
- ▶ Slide the starter battery into its anchorage across the direction of travel.

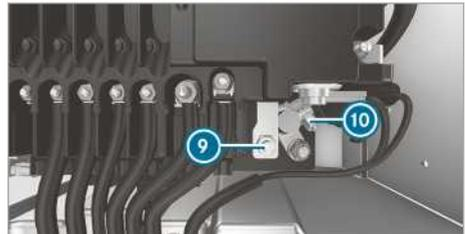
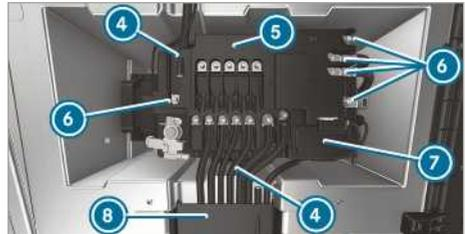

- ▶ Connect positive pole ⑩ and close cover ⑦.
- ▶ Place the wires on the support bolt.
- ▶ Tighten the nuts for wires ⑥ with torque specified on prefuse box ⑤.

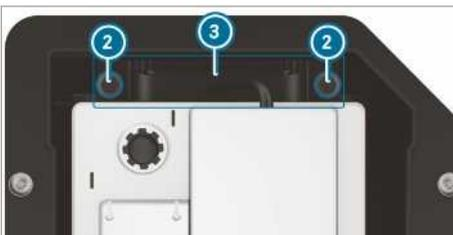

Mercedes-Benz recommends that you have the starter battery replaced at a qualified specialist workshop, e.g. a Mercedes-Benz Service Centre. If you want to replace the starter battery yourself, observe the following notes:

- Always replace a defective starter battery with a starter battery which meets the specific requirements of the vehicle.

- Carry over detachable parts such as the vent hose, elbow fitting or terminal cover from the starter battery to be replaced.
- Make sure that the vent hose is always connected to its original opening on the battery side.

Fit the existing or newly supplied stop plugs. Otherwise, gases or battery acid could escape.

- Make sure that the detachable parts are connected in the same way as before.

Disconnecting the auxiliary battery in the engine compartment

! NOTE Damage to the electrical assembly

By disconnecting the starter battery before the engine is switched off and the key is removed from the ignition lock, electrical assemblies could be damaged.

- ▶ Switch off the engine and remove the key from the ignition lock. Then, release the battery clamps of the starter battery.
- ▶ Always disconnect the starter battery in the battery case in the left footwell first. Otherwise, electrical assemblies, e.g. the alternator, could be damaged.

! NOTE Damage to the vehicle's electronics

Incorrectly disconnecting the auxiliary battery can cause damage to the vehicle's electronics.

- ▶ Always disconnect the auxiliary battery as described in the following sequence. Do not reverse the battery terminals under any circumstances.

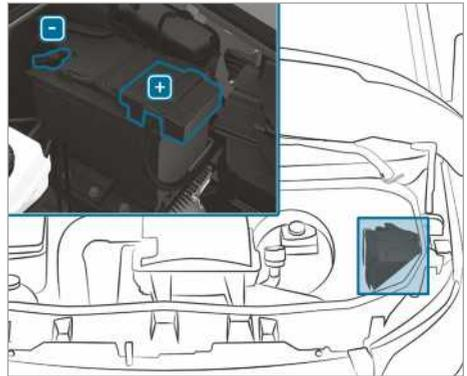

- ▶ Observe the safety measures and protection notices when disconnecting the auxiliary battery (→ page 296).
- ▶ Switch off all electrical consumers.
- ▶ Switch off the engine and the power supply.
- ▶ Open the bonnet (→ page 278).
- ▶ First loosen and remove the negative terminal clamp on the auxiliary battery so that the clamp is no longer in contact with the terminal.
- ▶ Remove the positive terminal clamp cover.
- ▶ Loosen and remove the positive terminal clamp.

Disconnecting the auxiliary battery under the co-driver's bench seat

! NOTE Damage to the electrical assembly

By disconnecting the starter battery before the engine is switched off and the key is removed from the ignition lock, electrical assemblies could be damaged.

- ▶ Switch off the engine and remove the key from the ignition lock. Then, release the battery clamps of the starter battery.
- ▶ Always disconnect the starter battery in the battery case in the left footwell first. Otherwise, electrical assemblies, e.g. the alternator, could be damaged.

! **NOTE** Damage to the vehicle's electronics

Incorrectly disconnecting the auxiliary battery can cause damage to the vehicle's electronics.

- ▶ Always disconnect the auxiliary battery as described in the following sequence. Do not reverse the battery terminals under any circumstances.

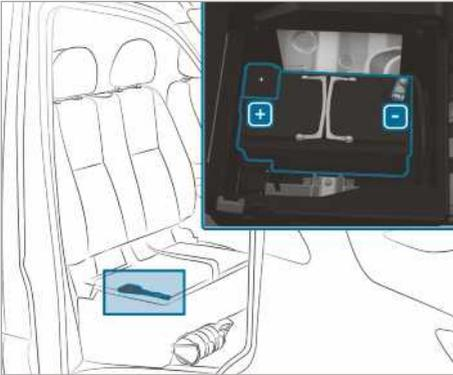

- ▶ Observe the safety measures and protection notices when disconnecting the auxiliary battery (→ page 296).
 - ▶ Switch off all electrical consumers.
 - ▶ Switch off the engine and the power supply.
 - ▶ Fold the co-driver's bench seat cushion up (→ page 71).
 - ▶ First loosen and remove the negative terminal clamp on the auxiliary battery so that the clamp is no longer in contact with the terminal.
 - ▶ Remove the positive terminal clamp cover.
 - ▶ Loosen and remove the positive terminal clamp.
- i** If the auxiliary battery is located under a co-driver's seat without a cushion which can be

folded up, contact a qualified specialist workshop to disconnect and remove the auxiliary battery.

Towing or tow-starting

Overview of permissible towing methods

In the event of a breakdown, Mercedes-Benz recommends that you have the vehicle transported instead of towed.

! **NOTE** Damage to the vehicle due to towing away incorrectly

- ▶ Observe the instructions and notes on towing away.

! **NOTE** Damage due to pushing the vehicle

A vehicle with a front wheel drive and automatic transmission may be damaged if it is pushed or towed too far and too fast when the engine is switched off.

- ▶ Do not push the vehicle more than 15 m faster than at walking pace.

- i** **Vehicles with automatic transmission and rear wheel drive:** if there is a malfunction, the automatic transmission may be locked in position **P**. If the automatic transmission cannot be shifted to position **N**, transport the vehicle (→ page 306). A towing vehicle with lifting equipment is required for vehicle transport.
- i** **Vehicles with automatic transmission and front wheel drive:** if there is a malfunction, the automatic transmission may be locked in position **P**. You can release the parking lock manually (→ page 131). If the automatic transmission cannot be shifted to position **N**, transport the vehicle (→ page 306). A towing vehicle with lifting equipment is required for vehicle transport.

Permissible towing methods

	 Both axles on the ground	 Front axle raised	 Rear axle raised
Vehicles with manual transmission	Yes, no further than 100 km at 50 km/h	Yes, no further than 100 km at 50 km/h	Yes, no further than 50 km at 50 km/h
Vehicles with automatic transmission and rear wheel drive	Yes, no further than 50 km at 50 km/h	Yes, no further than 50 km at 50 km/h	Yes, if the steering wheel is fixed in the centre position with a steering wheel lock
Vehicles with automatic transmission and front wheel drive	No (when the engine is switched off) Yes (when the engine is running), maximum 5 km at 20 km/h	Yes	No (when the engine is switched off) Yes (when the engine is running), maximum 5 km at 20 km/h
Vehicles with all-wheel drive	Yes, no further than 50 km at 50 km/h	No	No

Towing with a raised axle: towing should be performed by a towing company.

Towing away the vehicle with both axles on the ground

- ▶ Observe the notes on permissible towing methods (→ page 303).
- ▶ Make sure that the battery is connected and charged.

When the battery is discharged, the following situations occur:

- The engine cannot be started.
- It is not possible to release or apply the electric parking brake.
- **Vehicles with automatic transmission:** the automatic transmission cannot be shifted to position **N** or **P**.

I NOTE Damage due to pushing the vehicle

A vehicle with a front wheel drive and automatic transmission may be damaged if it is pushed or towed too far and too fast when the engine is switched off.

- ▶ Do not push the vehicle more than 15 m faster than at walking pace.

I NOTE Damage due to towing away at excessively high speeds or over long distances

The drivetrain could be damaged when towing at excessively high speeds or over long distances.

- ▶ A towing speed of 50 km/h must not be exceeded.
- ▶ A towing distance of 50 km must not be exceeded.

- i Vehicles with automatic transmission and rear wheel drive:** if there is a malfunction, the automatic transmission may be locked in position **P**.
If the automatic transmission cannot be shifted to position **N**, transport the vehicle (→ page 306). A towing vehicle with lifting equipment is required for vehicle transport.
- i Vehicles with automatic transmission and front wheel drive:** if there is a malfunction, the automatic transmission may be locked in position **P**. You can release the parking lock manually (→ page 131).

If the automatic transmission cannot be shifted to position **[N]**, transport the vehicle (→ page 306). A towing vehicle with lifting equipment is required for vehicle transport.

⚠ WARNING Risk of accident when towing a vehicle which is too heavy

If the vehicle being tow-started or towed away is heavier than the permissible gross mass, the following situations can occur:

- the towing eye may become detached.
 - the car/trailer combination may swerve or even overturn.
- ▶ If another vehicle is tow-started or towed away, its weight must not exceed the permissible gross mass of your own vehicle.

If a vehicle needs to be towed or tow started, its weight should not be greater than the permissible gross mass of the towing vehicle.

- ▶ Information on the vehicle's permissible gross mass can be found on the vehicle identification plate .
- ▶ **Vehicles with automatic transmission:** do not open the driver's or co-driver door, as the automatic transmission will automatically shift to position **[P]**.
- ▶ Fit the towing eye (→ page 307).
- ▶ Secure the towing device.

! **NOTE** Damage due to incorrect connection

- ▶ Only connect the tow rope or tow bar to the towing eyes.

i You can also secure the towing device to the trailer hitch.

! **NOTE** Damage and risk of accident when towing with a tow rope

There is a risk of an accident if you do not observe safety and protective measures when towing using a tow rope.

Observe the following points when towing with a tow rope:

- ▶ Secure the tow rope on the same side on both vehicles, if possible.

- ▶ Make sure the tow rope does not exceed the legally prescribed length.
- ▶ Mark the tow rope in the middle, e.g. with a white cloth (30 x 30 cm). This makes other road users aware that a vehicle is being towed.
- ▶ Observe the brake lamps of the towing vehicle while driving. Always maintain a distance that ensures the tow rope does not sag.
- ▶ do not use steel cables or chains to tow your vehicle. Otherwise, you could damage the vehicle.

- ▶ Deactivate automatic locking (→ page 49).
- ▶ Do not activate the HOLD function.
- ▶ Deactivate tow-away protection (→ page 62).
- ▶ Deactivate Active Brake Assist (→ page 156).
- ▶ **Vehicles with automatic transmission:** shift the automatic transmission to position **[N]**.
- ▶ **Vehicles with manual transmission:** shift to neutral **[N]**.
- ▶ Release the parking brake.
- ▶ **Vehicles with manual transmission:** switch on the ignition otherwise the steering wheel locking may engage.

⚠ WARNING Risk of accident due to limited safety-related functions during the towing process

Safety-related functions are limited or no longer available in the following situations:

- the ignition is switched off.
- the brake system or power steering system is malfunctioning.
- the energy supply or the on-board electrical system is malfunctioning.

When your vehicle is then towed away, significantly more effort may be required to steer and brake than is normally required.

- ▶ Use a tow bar.
- ▶ Make sure that the steering wheel can move freely, before towing the vehicle away.

! **NOTE** Damage due to excessive tractive power

If you pull away sharply, the tractive power may be too high and the vehicles could be damaged.

► Pull away slowly and smoothly.

Towing a vehicle with the front or rear axle raised

! **NOTE** Damage when the ignition is switched on

If you leave the ignition switched on when towing the vehicle with the front or rear axle raised, ESP® actuation can damage the brake system.

► The ignition must be switched off.

! **NOTE** Damage due to incorrect removal or installation of the propeller shafts

When installing the propeller shafts, they can be damaged if you do not use new screws. Always use new screws when installing the propeller shafts.

Only have the propeller shafts installed or removed by qualified, skilled personnel.

i If the front axle is damaged, raise the vehicle at the front axle and if the rear axle is damaged, raise the vehicle at the rear axle.

i **Vehicles with automatic transmission and rear wheel drive:** if there is a malfunction, the automatic transmission may be locked in position **P**. If the automatic transmission cannot be shifted to position **N**, transport the vehicle (→ page 306). A towing vehicle with lifting equipment is required for vehicle transport.

i **Vehicles with automatic transmission and front wheel drive:** if there is a malfunction, the automatic transmission may be locked in position **P**. You can release the parking lock manually (→ page 131). If the automatic transmission cannot be shifted to position **N**, transport the vehicle (→ page 306). A towing vehicle with lifting equipment is required for vehicle transport.

► Observe the notes on permissible towing methods (→ page 303).

► The propeller shafts to the drive axles must be removed if the maximum permissible towing distance is exceeded.

► **Vehicles with automatic transmission:** shift the automatic transmission to position **N**.

► **Vehicles with manual transmission:** shift to neutral **N**.

► Release the parking brake.

► Switch off the ignition.

Loading the vehicle for transport

► Observe the notes on towing away (→ page 304) (→ page 306).

► Connect the tow bar to the towing eye to load the vehicle.

► **Vehicles with automatic transmission:** shift the automatic transmission to position **N**.

i **Vehicles with automatic transmission:** in the event of damage to the electrics, the automatic transmission may be locked in position **P**. To shift to position **N**, provide the on-board electrical system with power (→ page 296).

► **Vehicles with manual transmission:** shift to neutral **N**.

► Load the vehicle onto the transporter.

► **Vehicles with automatic transmission:** shift the automatic transmission to position **P**.

► **Vehicles with manual transmission:** engage first **1** or reverse gear **R**.

► Use the parking brake to secure the vehicle against rolling away.

► Only secure the vehicle by the wheels.

Vehicles with all-wheel drive/vehicles with automatic transmission

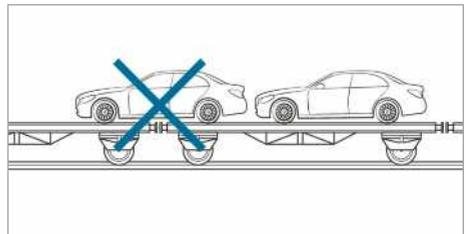

- ▶ Make sure that the front and rear axles come to rest on the same transportation vehicle.

! **NOTE** Damage to the drivetrain due to incorrect positioning

- ▶ Do not position the vehicle above the connection point of the transport vehicle.

! **NOTE** Vehicle damage due to improper loading

An all-wheel drive vehicle may be damaged if it is tilted, pushed or moved while being loaded using a hydraulic platform.

- ▶ When loading a vehicle with all-wheel drive, the vehicle should only be moved and positioned by its own power.
- ▶ The vehicle and the surface it is positioned on should no longer be moved when the key is removed or if the door is open.

Towing eye storage location

The towing eye is located in the vehicle tool kit in the front passenger footwell (→ page 309).

Fitting/removing the towing eye

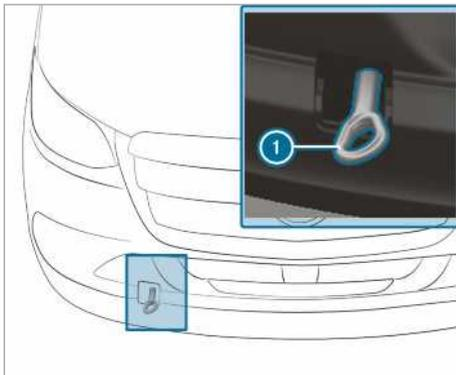

Fitting and removing the front towing eye

- ▶ **To fit the front towing eye:** press the top of the cover and remove the cover.
- ▶ Screw in towing eye ① clockwise to the stop and tighten.

- ▶ **To remove the front towing eye:** unscrew towing eye ① anti-clockwise.

- ▶ Insert the cover with the tabs at the top and push in at the bottom until the cover engages.

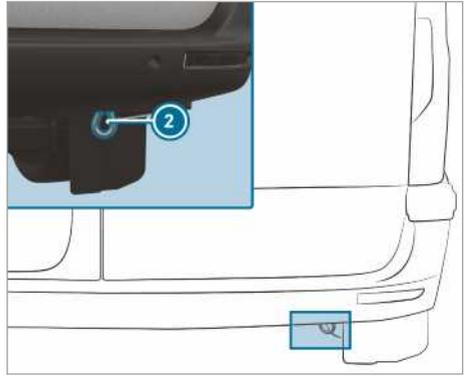

Rear towing eye (vehicles with passenger vehicle approval)

- ① Rear towing eye ② is permanently attached to the vehicle.

! **NOTE** Damage due to incorrect use of the towing eye

When a towing eye is used to recover a vehicle, the vehicle may be damaged in the process.

- ▶ Only use the towing eye to tow away or tow start the vehicle.

Tow starting vehicle (emergency engine start)

Vehicles with automatic transmission

! **NOTE** Damage to the automatic transmission due to tow-starting

The automatic transmission may be damaged in the process of tow-starting vehicles with automatic transmission.

- ▶ Vehicles with automatic transmission must not be tow-started.

- ▶ Do not tow start vehicles with automatic transmission.

Vehicles with manual transmission

- ▶ Observe the notes on towing away (→ page 303).

- ▶ If necessary, allow the engine and the exhaust system to cool down.
- ▶ Switch on the ignition.
- ▶ Engage 2nd or 3rd gear.
- ▶ Release the parking brake.
- ▶ Keep the clutch pedal fully depressed when tow starting the vehicle.
- ▶ Release the clutch pedal slowly.
- ▶ When the engine has started, engage neutral immediately.
- ▶ Stop in a safe location.
- ▶ Remove the towing device.
- ▶ Remove the towing eye.
- ▶ Have the vehicle checked at a qualified specialist workshop.

Electrical fuses

Notes on electrical fuses

⚠ WARNING Risk of accident and injury due to overloaded lines

If you manipulate or bridge a faulty fuse or if you replace it with a fuse with a higher amperage, the electric line could be overloaded.

This could result in a fire.

- ▶ Always replace faulty fuses with specified new fuses containing the correct amperage.

! NOTE Damage due to incorrect fuses

Electrical components or systems could be damaged by incorrect fuses.

- ▶ Only use fuses which have been approved by Mercedes-Benz and which have the correct fuse rating.

The electrical fuses in your vehicle switch off defective circuits. If a fuse blows, all the components on the circuit and their functions will cease to operate.

Blown fuses must be replaced with fuses of an equivalent specification, which you can determine by the colour and fuse rating. The fuse allocation chart and further information on the electric fuses and relays can be found in the "Fuse allocation chart" supplement.

! NOTE Damage or malfunctions caused by moisture

Moisture may cause damage to the electrical system or cause it to malfunction.

- ▶ When the fuse box is open, make sure that no moisture can enter the fuse box.
- ▶ When closing the fuse box, make sure that the seal of the lid is positioned correctly on the fuse box.

If the new fuse which has been inserted also blows, have the cause traced and rectified at a qualified specialist workshop.

Make sure of the following before replacing a fuse:

- the vehicle is secured such that it does not roll away
- all electrical consumers are switched off
- the ignition is switched off

The fuses are located in various fuse boxes:

- fuse box in the co-driver's footwell (→ page 309)
- fuse box in the seat base of the driver's seat (→ page 308)

Opening the fuse box in the seat base of the driver's seat

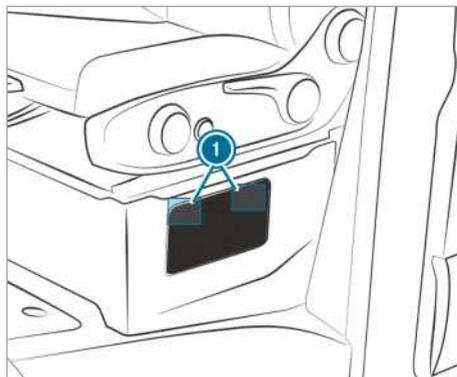

- ▶ **To open:** press down and unclip fasteners ① on the cover.
- ▶ Remove the cover.

Opening the fuse box in the co-driver footwell

- ▶ Unlocking and removing the stowage compartment cover in the co-driver footwell (→ page 309).

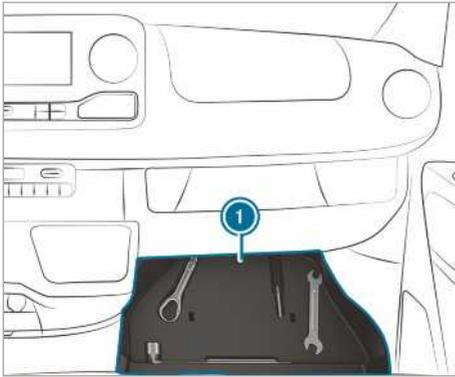

- ▶ Remove insert ① with the vehicle tool kit.

Vehicle tool kit

Information on the vehicle tool kit

The vehicle tool kit is located in the stowage compartment in the footwell on the co-driver side (→ page 309).

The vehicle tool kit contains:

- a towing eye
- a screwdriver with Torx, Phillips and slotted bits

The vehicle tool kit may also contain the following, for example:

- an open-end spanner
- a wheel spanner

Unlocking and removing the stowage compartment cover

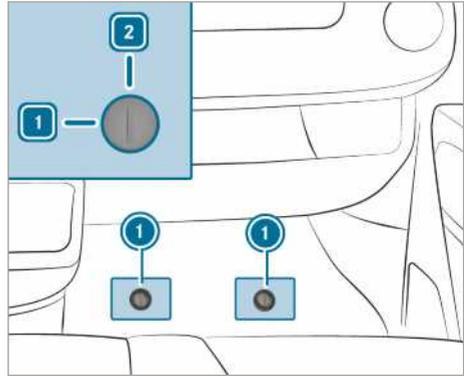

- ▶ Remove the rubber mat from the co-driver's footwell.
- ▶ **To unlock:** turn the quick-release fastener ① anti-clockwise to position 1.
- ▶ Slightly raise and pull out the cover.

Inserting and locking the cover

- ▶ Slide in the cover and press it downwards.
- ▶ Press down the quick-release fastener ① until it engages.
- ▶ **To lock:** turn the quick-release fastener ① clockwise to position 2.

Removing the vehicle tool kit

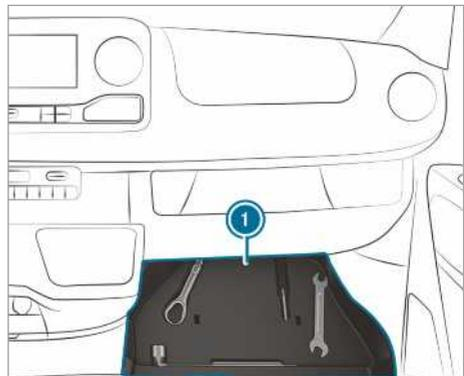

- ▶ Remove the vehicle tool kit from the stowage compartment ①.

Hydraulic jack

Information on the hydraulic jack

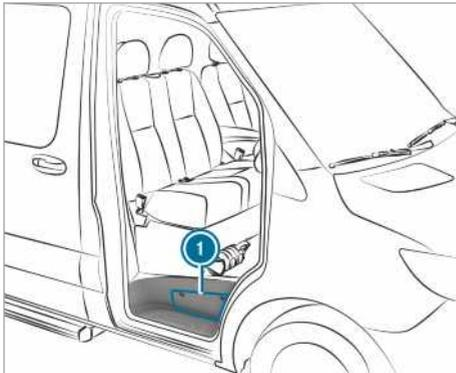

The hydraulic jack is located in side compartment ① above the co-driver's door step.

The jack has a maximum weight of 7.5 kg depending on the vehicle's equipment. You will find the maximum load capacity of the jack stated on the adhesive label attached to the jack. If there is a malfunction, please contact a qualified specialist workshop.

Jack maintenance:

- Clean and grease all moving parts after use.
- Extend and retract the pistons fully every six months.

Removing the pump lever rod and the jack

Requirements:

- The co-driver door is open.

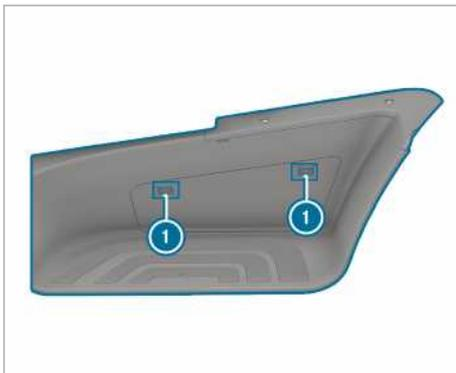

- ▶ **To open:** press down and unclip fasteners ① on the cover.
- ▶ Remove the cover.
- ▶ Pull out the holder completely and place it on the step.



- ▶ Remove jack ② and the pump lever rod.
- ▶ **To close:** press the cover firmly so that fasteners ① engage.

Information on noise or unusual driving characteristics

While driving, pay attention to vibrations, noises and unusual driving characteristics, e.g. pulling to one side. This may indicate damage to the wheels or tyres. If you suspect that a tyre is defective, reduce your speed. Stop the vehicle as soon as possible to check if wheels and tyres have been damaged or are no longer functioning properly. Hidden tyre damage could also be causing the unusual driving characteristics. If no signs of damage can be detected, have the tyres and wheels checked at a qualified specialist workshop.

Notes on regularly inspecting wheels and tyres

⚠ WARNING Risk of accident from damaged tyres

Damaged tyres can cause tyre pressure loss. As a result, you could lose control of your vehicle.

- ▶ Check the tyres regularly for signs of damage and replace any damaged tyres immediately.

Check the wheels and tyres of your vehicle for damage regularly, i.e. at least every two weeks, as well as after driving off-road or on rough roads. Damaged wheels can lead to a loss of tyre pressure.

Look out for the following types of damage, for example:

- cuts in the tyres
- punctures in the tyres
- tears in the tyres
- bulges on tyres
- deformation or severe corrosion on wheels

⚠ WARNING Risk of aquaplaning due to insufficient tyre tread

Insufficient tyre tread will result in reduced tyre grip. The tyre tread is no longer able to dissipate water.

This means that in heavy rain or slush the risk of aquaplaning is increased, in particular where speed is not adapted to suit the conditions.

If the tyre pressure is too high or too low, tyres may exhibit different levels of wear at different locations on the tyre tread.

- ▶ Thus, you should regularly check the tread depth and the condition of the tread across the entire width of all tyres.

Minimum tread depth for:

- Summer tyres: 3 mm
 - M+S tyres: 4 mm
- ▶ For safety reasons, replace the tyres before the legally prescribed limit for the minimum tread depth is reached.

Conduct the following checks regularly on all wheels, at least once a month or as required, e.g. before a long journey or when driving off-road:

- check the tyre pressure (→ page 313)
 - check the valve caps
- Valves must be protected from moisture and dirt with valve caps specifically approved by Mercedes-Benz for your vehicle.
- visually inspect the tread depth and the tyre tread across the whole tyre width

For summer tyres, the minimum tread depth is 3 mm and for winter tyres 4 mm.

Information on driving with summer tyres

At temperatures below 10 °C summer tyres lose elasticity and therefore traction and braking power. Change the tyres on your vehicle to M+S tyres. Using summer tyres at very cold temperatures could cause tears to form, thereby damaging the tyres permanently. Mercedes-Benz cannot accept responsibility for this type of damage.

Always observe the maximum permissible speed specified for the summer tyres you have fitted .

Once you have fitted the summer tyres:

- Check the tyre pressures (→ page 313)
- Restart the tyre pressure monitor (→ page 329)

Information on M+S tyres

Use winter tyres or all-season tyres at temperatures below 10 °C. Both types of tyre are identified by the M+S marking.

Only winter tyres bearing the  snowflake symbol in addition to the M+S marking provide the best possible grip in wintry road conditions.

Only these tyres will allow driving safety systems such as ABS and ESP® to function optimally in winter. These tyres have been developed specifically for driving in snow.

Use M+S tyres of the same make and tread on all wheels to maintain safe handling characteristics.

Always observe the maximum permissible speed specified for the M+S tyres you have fitted .

If you fit M+S tyres that have a lower maximum permissible speed than the maximum design speed of the vehicle, affix an appropriate warning sign in the driver's field of vision. You can obtain this at a qualified specialist workshop.

For vehicles with a limiter: in this case, you should also restrict the maximum design speed of the vehicle using the permanent limiter so that it does not exceed the maximum permissible speed for the M+S tyres (→ page 159).

Once you have fitted the winter tyres, take the following measures:

- Check the tyre pressure (→ page 313)
- Restart the tyre pressure monitor (→ page 329)

Notes on snow chains

⚠ WARNING Risk of accident due to incorrect fitting of snow chains

Vehicles with rear-wheel drive: if you have fitted snow chains to the front wheels, they may drag against the vehicle body or chassis components.

This could cause damage to the vehicle or the tyres.

- ▶ Never fit snow chains on the front wheels.
- ▶ Only fit snow chains on the rear wheels in pairs.
- ▶ **Vehicles with twin tyres:** fit the snow chains to the outer wheels.

⚠ WARNING Risk of accident due to incorrect fitting of snow chains

Vehicles with front-wheel drive: if you have fitted snow chains to the rear wheels, they

may drag against the vehicle body or chassis components.

This could cause damage to the vehicle or the tyres.

- ▶ Never fit snow chains on the rear wheels.
- ▶ Only fit snow chains on the front wheels in pairs.

⚠ WARNING Risk of accident due to unsuitable snow chains

Vehicles with all-wheel drive, or front-wheel drive and single tyres, do not have sufficient clearance on the front axle for commercially available snow chains.

When you fit commercially available snow chains, the snow chains may come loose and damage chassis components or brake hoses.

- ▶ Only fit snow chains on vehicles with all-wheel drive, or front-wheel drive and single tyres, which have been approved for these tyres by Mercedes-Benz.

For safety reasons, Mercedes-Benz recommends that you only use snow chains that have been checked and approved. You can find further information on snow chains recommended for Mercedes-Benz in the wheel and tyre overview at <https://www.mercedes-benz.de>.

! NOTE Damage to the wheel trim from fitted snow chains

If snow chains are fitted to steel wheels, the wheel trims can be damaged.

- ▶ Remove the wheel trims of steel wheels before fitting snow chains.

Observe the following notes when using snow chains:

- Snow chains are only permissible for certain wheel/tyre combinations. You can obtain information on them at a qualified specialist workshop.
- For safety reasons, only use snow chains that have been specifically approved for your vehicle by Mercedes-Benz, or snow chains with the same quality standard.
- The snow chains must be retightened after driving approximately 1 km. This is the only way to ensure the snow chains are optimally

seated with clearance to adjacent components.

- **Vehicles with all-wheel drive:** fit snow chains to all wheels. On vehicles with twin tyres, fit the snow chains to the outer wheels. Observe the manufacturer's installation instructions.
 - Use snow chains only when the road surface is completely snow-covered. Remove the snow chains as soon as possible when you come to a road that is not snow-covered.
 - Local regulations may restrict the use of snow chains. Observe the applicable regulations before fitting snow chains.
 - Activate all-wheel drive before driving off with snow chains (→ page 132).
 - If snow chains are fitted, the maximum permissible speed is 50 km/h.
 - **Vehicles with Parking Assist:** do not use Parking Assist PARKTRONIC if snow chains are fitted.
- ⓘ You can permanently limit the maximum vehicle speed for driving with winter tyres (→ page 159).
- ⓘ You can deactivate ESP® to pull away (→ page 154). This allows the wheels to spin, achieving an increased driving force.

- at least once a month
 - when the load changes
 - before embarking on a longer journey
 - if operating conditions change, e.g. off-road driving
- ▶ Adjust the tyre pressure as necessary.

Driving with tyre pressure that is too high or too low can:

- Shorten the service life of the tyres.
- Cause increased tyre damage.
- Adversely affect handling characteristics and thus driving safety, e.g. due to aquaplaning.

⚠ WARNING Risk of accident from repeated tyre pressure drop

If the tyre pressure drops repeatedly, the wheel, valve or tyre may be damaged.

Insufficient tyre pressure can cause the tyres to burst.

- ▶ Inspect the tyre for signs of foreign objects.
- ▶ Check whether the wheel or valve has a leak.
- ▶ If you are unable to rectify the damage, contact a qualified specialist workshop.

Tyre pressure

Notes on tyre pressure

⚠ WARNING Risk of accident due to insufficient or excessive tyre pressure

Underinflated or overinflated tyres pose the following risks:

- The tyres may burst, especially as the load and vehicle speed increase.
- The tyres may wear excessively and/or unevenly, which may greatly impair tyre traction.
- The driving characteristics, as well as steering and braking, may be greatly impaired.

- ▶ Comply with the recommended tyre pressure and check the tyre pressure of all tyres including the spare wheel regularly:

Information on the recommended tyre pressure for the vehicle's factory-fitted tyres can be found on the tyre pressure table on the driver's seat base or on the B-pillar on the driver's side.

Use a suitable pressure gauge to check the tyre pressure. The outer appearance of a tyre does not permit any reliable conclusion about the tyre pressure.

Vehicles with a tyre pressure monitor: you can also check the tyre pressure using the on-board computer.

Only correct tyre pressures when the tyres are cold. Conditions for cold tyres:

- The vehicle has been parked with the tyres out of direct sunlight for at least three hours.
- The vehicle has travelled less than 1.6 km.

A rise in the tyre temperature of 10 °C increases the tyre pressure by approx. 10 kPa (0.1 bar / 1.5 psi). Take this into account when checking the tyre pressure of warm tyres.

Notes on towing a trailer

The applicable tyre pressure for the tyres of the rear axle is always the recommended tyre pressure for a full load.

Tyre pressure table

The tyre pressure table can be found on the seat base or on the B-pillar on the driver's side.

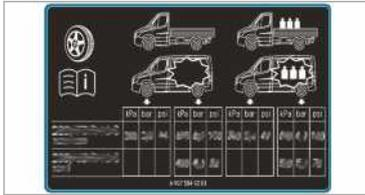

The tyre pressure table shows the recommended tyre pressure for the tyres fitted at the factory on this vehicle. The recommended tyre pressures are valid for cold tyres and different vehicle load conditions.

If one or more tyre sizes precede a tyre pressure, the tyre pressure information following is only valid for those tyre sizes.

If the preceding tyre sizes are supplemented by the  symbol, the tyre pressure information following shows alternative tyre pressures.

The load conditions "empty" and "fully laden" are defined in the table for varying weights.

Front axle tyre pressures on vehicles with front wheel drive

Max. front axle load 1750 kg

Tyres/disc wheel	Vehicle load	Max. front axle load 1750 kg
225/65R16C 112/110R	Fully laden	360 kPa (3.6 bar/52 psi)
225/65R16C 112/110R	Empty	330 kPa (3.3 bar/48 psi)
225/75R16C 118/116R	Fully laden	320 kPa (3.2 bar/46 psi)
225/75R16C 118/116R	Empty	300 kPa (3.0 bar/44 psi)
225/75R16C 121/120R	Fully laden	320 kPa (3.2 bar/46 psi)
225/75R16C 121/120R	Empty	300 kPa (3.0 bar/44 psi)
235/60R17C 117/115R ¹⁾	Fully laden	340 kPa (3.4 bar/49 psi)
235/60R17C 117/115R ¹⁾	Empty	310 kPa (3.1 bar/45 psi)
235/60R17C 117/115S ¹⁾	Fully laden	340 kPa (3.4 bar/49 psi)
235/60R17C 117/115S ¹⁾	Empty	310 kPa (3.1 bar/45 psi)

¹⁾ Tyre on the spare wheel: 235/65 R16C 121/119R or 235/65 R16C 118/116R – air pressure: 4.9 bar

Max. front axle load 1850 kg

Tyres/disc wheel	Vehicle load	Max. front axle load 1850 kg
225/65R16C 112/110R	Fully laden	390 kPa (3.9 bar/57 psi)
225/65R16C 112/110R	Empty	330 kPa (3.3 bar/48 psi)

Tyres/disc wheel	Vehicle load	Max. front axle load 1850 kg
225/75R16C 118/116R	Fully laden	350 kPa (3.5 bar/51 psi)
225/75R16C 118/116R	Empty	300 kPa (3.0 bar/44 psi)
225/75R16C 121/120R	Fully laden	350 kPa (3.5 bar/51 psi)
225/75R16C 121/120R	Empty	300 kPa (3.0 bar/44 psi)
235/60R17C 117/115R ¹⁾	Fully laden	360 kPa (3.6 bar/52 psi)
235/60R17C 117/115R ¹⁾	Empty	310 kPa (3.1 bar/45 psi)
235/60R17C 117/115S ¹⁾	Fully laden	360 kPa (3.6 bar/52 psi)
235/60R17C 117/115S ¹⁾	Empty	310 kPa (3.1 bar/45 psi)

¹⁾ Tyre on the spare wheel: 235/65 R16C
121/119R or 235/65 R16C 118/116R – air pressure: 4.9 bar

Max. front axle load 2000 kg

Tyres/disc wheel	Vehicle load	Max. front axle load 2000 kg
225/65R16C 112/110R	Fully laden	-
225/65R16C 112/110R	Empty	-
225/75R16C 118/116R	Fully laden	380 kPa (3.8 bar/55 psi)
225/75R16C 118/116R	Empty	300 kPa (3.0 bar/44 psi)
225/75R16C 121/120R	Fully laden	380 kPa (3.8 bar/55 psi)
225/75R16C 121/120R	Empty	300 kPa (3.0 bar/44 psi)
235/60R17C 117/115R ¹⁾	Fully laden	400 kPa (4.0 bar/58 psi)
235/60R17C 117/115R ¹⁾	Empty	310 kPa (3.1 bar/45 psi)
235/60R17C 117/115S ¹⁾	Fully laden	400 kPa (4.0 bar/58 psi)
235/60R17C 117/115S ¹⁾	Empty	310 kPa (3.1 bar/45 psi)

¹⁾ Tyre on the spare wheel: 235/65 R16C
121/119R or 235/65 R16C 118/116R – air pressure: 4.9 bar

Max. front axle load 2100 kg

Tyres/disc wheel	Vehicle load	Max. front axle load 2100 kg
225/65R16C 112/110R	Fully laden	-
225/65R16C 112/110R	Empty	-
225/75R16C 118/116R	Fully laden	410 kPa (4.1 bar/60 psi)
225/75R16C 118/116R	Empty	300 kPa (3.0 bar/44 psi)
225/75R16C 121/120R	Fully laden	410 kPa (4.1 bar/60 psi)
225/75R16C 121/120R	Empty	300 kPa (3.0 bar/44 psi)
235/60R17C 117/115R ¹⁾	Fully laden	420 kPa (4.2 bar/61 psi)
235/60R17C 117/115R ¹⁾	Empty	310 kPa (3.1 bar/45 psi)
235/60R17C 117/115S ¹⁾	Fully laden	420 kPa (4.2 bar/61 psi)
235/60R17C 117/115S ¹⁾	Empty	310 kPa (3.1 bar/45 psi)

¹⁾ Tyre on the spare wheel: 235/65 R16C
121/119R or 235/65 R16C 118/116R – air pressure: 4.9 bar

Rear axle tyre pressures on vehicles with front wheel drive

Max. rear axle load 2100 kg

Tyres/disc wheel	Vehicle load	Max. rear axle load 2100 kg
225/65R16C 112/110R	Fully laden	450 kPa (4.5 bar/65 psi)
225/65R16C 112/110R	Empty	330 kPa (3.3 bar/48 psi)
225/75R16C 118/116R	Fully laden	410 kPa (4.1 bar/60 psi)
225/75R16C 118/116R	Empty	300 kPa (3.0 bar/44 psi)
225/75R16C 121/120R	Fully laden	410 kPa (4.1 bar/60 psi)
225/75R16C 121/120R	Empty	300 kPa (3.0 bar/44 psi)
235/60R17C 117/115R ¹⁾	Fully laden	420 kPa (4.2 bar/61 psi)
235/60R17C 117/115R ¹⁾	Empty	310 kPa (3.1 bar/45 psi)
235/60R17C 117/115S ¹⁾	Fully laden	420 kPa (4.2 bar/61 psi)
235/60R17C 117/115S ¹⁾	Empty	310 kPa (3.1 bar/45 psi)

¹⁾ Tyre on the spare wheel: 235/65 R16C
121/119R or 235/65 R16C 118/116R – air pressure: 4.9 bar

Max. rear axle load 2430 kg

Tyres/disc wheel	Vehicle load	Max. rear axle load 2430 kg
225/65R16C 112/110R	Fully laden	-
225/65R16C 112/110R	Empty	-
225/75R16C 118/116R	Fully laden	490 kPa (4.9 bar/71 psi)
225/75R16C 118/116R	Empty	300 kPa (3.0 bar/44 psi)
225/75R16C 121/120R	Fully laden	490 kPa (4.9 bar/71 psi)
225/75R16C 121/120R	Empty	300 kPa (3.0 bar/44 psi)
235/60R17C 117/115R ¹⁾	Fully laden	500 kPa (5.0 bar/73 psi)
235/60R17C 117/115R ¹⁾	Empty	310 kPa (3.1 bar/45 psi)
235/60R17C 117/115S ¹⁾	Fully laden	500 kPa (5.0 bar/73 psi)
235/60R17C 117/115S ¹⁾	Empty	310 kPa (3.1 bar/45 psi)

¹⁾ Tyre on the spare wheel: 235/65 R16C
121/119R or 235/65 R16C 118/116R – air pressure: 4.9 bar

Front axle tyre pressures on motor caravan vehicles with front wheel drive**Motor caravan, max. front axle load 1850 kg**

Tyres/disc wheel	Vehicle load	Max. front axle load 1850 kg
225/75R16CP 118R	Fully laden	350 kPa (3.5 bar/51 psi)
225/75 R16C 121/120 R	Fully laden	350 kPa (3.5 bar/51 psi)
235/60R17C 117/115R ¹⁾	Fully laden	360 kPa (3.6 bar/52 psi)
235/60R17C 117/115S ¹⁾	Fully laden	360 kPa (3.6 bar/52 psi)

¹⁾ Tyre on the spare wheel: 235/65 R16C
121/119R or 235/65 R16C 118/116R – air pressure: 4.9 bar

Motor caravan, max. front axle load 2000 kg

Tyres/disc wheel	Vehicle load	Max. front axle load 2000 kg
225/75R16CP 118R	Fully laden	380 kPa (3.8 bar/55 psi)
225/75 R16C 121/120 R	Fully laden	380 kPa (3.8 bar/55 psi)

Tyres/disc wheel	Vehicle load	Max. front axle load 2000 kg
235/60R17C 117/115R ¹⁾	Fully laden	400 kPa (4.0 bar/58 psi)
235/60R17C 117/115S ¹⁾	Fully laden	400 kPa (4.0 bar/58 psi)

¹⁾ Tyre on the spare wheel: 235/65 R16C
121/119R or 235/65 R16C 118/116R – air pressure: 4.9 bar

Motor caravan, max. front axle load 2100 kg

Tyres/disc wheel	Vehicle load	Max. front axle load 2100 kg
225/75R16CP 118R	Fully laden	410 kPa (4.1 bar/60 psi)
225/75 R16C 121/120 R	Fully laden	410 kPa (4.1 bar/60 psi)
235/60R17C 117/115R ¹⁾	Fully laden	420 kPa (4.2 bar/61 psi)
235/60R17C 117/115S ¹⁾	Fully laden	420 kPa (4.2 bar/61 psi)

¹⁾ Tyre on the spare wheel: 235/65 R16C
121/119R or 235/65 R16C 118/116R – air pressure: 4.9 bar

 Due to the high unladen weight of the motor caravan vehicles, empty tyre pressures are not intended and not permitted.

Rear axle tyre pressures on motor caravan vehicles with front wheel drive

Motor caravan, max. rear axle load 2100 kg

Tyres/disc wheel	Vehicle load	Max. rear axle load 2100 kg
225/75R16CP 118R	Fully laden	480 kPa (4.8 bar/70 psi)
225/75 R16C 121/120 R	Fully laden	480 kPa (4.8 bar/70 psi)
235/60R17C 117/115R ¹⁾	Fully laden	480 kPa (4.8 bar/70 psi)
235/60R17C 117/115S ¹⁾	Fully laden	480 kPa (4.8 bar/70 psi)

¹⁾ Tyre on the spare wheel: 235/65 R16C
121/119R or 235/65 R16C 118/116R – air pressure: 4.9 bar

Motor caravan, max. rear axle load 2430 kg

Tyres/disc wheel	Vehicle load	Max. rear axle load 2430 kg
225/75R16CP 118R	Fully laden	550 kPa (4.8 bar/70 psi)
225/75 R16C 121/120 R	Fully laden	550 kPa (4.8 bar/70 psi)

Tyres/disc wheel	Vehicle load	Max. rear axle load 2430 kg
235/60R17C 117/115R ¹⁾	Fully laden	530 kPa (4.8 bar/70 psi)
235/60R17C 117/115S ¹⁾	Fully laden	530 kPa (4.8 bar/70 psi)

¹⁾ Tyre on the spare wheel: 235/65 R16C
121/119R or 235/65 R16C 118/116R – air pressure: 4.9 bar

Motor caravan, max. rear axle load 2500 kg

Tyres/disc wheel	Vehicle load	Max. rear axle load 2500 kg
225/75R16CP 118R	Fully laden	550 kPa (5.5 bar/80 psi)
225/75 R16C 121/120 R	Fully laden	550 kPa (5.5 bar/80 psi)

Motor caravan with three axles, max. rear axle load per rear axle 1800 kg

Tyres/disc wheel	Vehicle load	Max. rear axle load 1800 kg
225/75R16CP 118R	Fully laden	400 kPa (4.0 bar/58 psi)
225/75 R16C 121/120 R	Fully laden	400 kPa (4.0 bar/58 psi)

i Due to the high unladen weight of the motor caravan vehicles, empty tyre pressures are not intended and not permitted.

Front axle tyre pressures on vehicles with rear wheel drive and Single tyres

Max. front axle load 1650 kg

Tyres/disc wheel	Vehicle load	Max. front axle load 1650 kg
205/75R16C 110/108R	Fully laden	360 kPa (3.6 bar/52 psi)
205/75R16C 110/108R	Empty	330 kPa (3.3 bar/48 psi)
225/75R16C 121/120R	Fully laden	300 kPa (3.0 bar/44 psi)
225/75R16C 121/120R	Empty	300 kPa (3.0 bar/44 psi)
225/75R16C 118/116R	Fully laden	300 kPa (3.0 bar/44 psi)
225/75R16C 118/116R	Empty	300 kPa (3.0 bar/44 psi)
235/65R16C 115/113R	Fully laden	300 kPa (3.0 bar/44 psi)
235/65R16C 115/113R	Empty	300 kPa (3.0 bar/44 psi)
235/65R16C 121/119R	Fully laden	300 kPa (3.0 bar/44 psi)

Tyres/disc wheel	Vehicle load	Max. front axle load 1650 kg
235/65R16C 121/119R	Empty	300 kPa (3.0 bar/44 psi)
235/65R16C 118/116R	Fully laden	300 kPa (3.0 bar/44 psi)
235/65R16C 118/116R	Empty	300 kPa (3.0 bar/44 psi)
235/60R17C 117/115R	Fully laden	320 kPa (3.2 bar/46 psi)
235/60R17C 117/115R	Empty	310 kPa (3.1 bar/45 psi)
235/60R17C 117/115S	Fully laden	320 kPa (3.2 bar/46 psi)
235/60R17C 117/115S	Empty	310 kPa (3.1 bar/45 psi)

Max. front axle load 1740 kg

Tyres/disc wheel	Vehicle load	Max. front axle load 1740 kg
205/75R16C 110/108R	Fully laden	380 kPa (3.6 bar/55 psi)
205/75R16C 110/108R	Empty	330 kPa (3.3 bar/48 psi)
225/75R16C 121/120R	Fully laden	320 kPa (3.2 bar/46 psi)
225/75R16C 121/120R	Empty	300 kPa (3.0 bar/44 psi)
225/75R16C 118/116R	Fully laden	320 kPa (3.2 bar/46 psi)
225/75R16C 118/116R	Empty	300 kPa (3.0 bar/44 psi)
235/65R16C 115/113R	Fully laden	320 kPa (3.2 bar/46 psi)
235/65R16C 115/113R	Empty	300 kPa (3.0 bar/44 psi)
235/65R16C 121/119R	Fully laden	320 kPa (3.2 bar/46 psi)
235/65R16C 121/119R	Empty	300 kPa (3.0 bar/44 psi)
235/65R16C 118/116R	Fully laden	320 kPa (3.2 bar/46 psi)
235/65R16C 118/116R	Empty	300 kPa (3.0 bar/44 psi)
235/60R17C 117/115R	Fully laden	340 kPa (3.4 bar/49 psi)
235/60R17C 117/115R	Empty	310 kPa (3.1 bar/45 psi)
235/60R17C 117/115S	Fully laden	340 kPa (3.4 bar/49 psi)
235/60R17C 117/115S	Empty	310 kPa (3.1 bar/45 psi)

Max. front axle load 1860 kg

Tyres/disc wheel	Vehicle load	Max. front axle load 1860 kg
205/75R16C 110/108R	Fully laden	-
205/75R16C 110/108R	Empty	-
225/75R16C 121/120R	Fully laden	350 kPa (3.5 bar/51 psi)
225/75R16C 121/120R	Empty	300 kPa (3.0 bar/44 psi)
225/75R16C 118/116R	Fully laden	350 kPa (3.5 bar/51 psi)
225/75R16C 118/116R	Empty	300 kPa (3.0 bar/44 psi)
235/65R16C 115/113R	Fully laden	350 kPa (3.5 bar/51 psi)
235/65R16C 115/113R	Empty	300 kPa (3.0 bar/44 psi)
235/65R16C 121/119R	Fully laden	350 kPa (3.5 bar/51 psi)
235/65R16C 121/119R	Empty	300 kPa (3.0 bar/44 psi)
235/65R16C 118/116R	Fully laden	350 kPa (3.5 bar/51 psi)
235/65R16C 118/116R	Empty	300 kPa (3.0 bar/44 psi)
235/60R17C 117/115R	Fully laden	380 kPa (3.8 bar/55 psi)
235/60R17C 117/115R	Empty	310 kPa (3.1 bar/45 psi)
235/60R17C 117/115S	Fully laden	380 kPa (3.8 bar/55 psi)
235/60R17C 117/115S	Empty	310 kPa (3.1 bar/45 psi)

Max. front axle load 2000 kg

Tyres/disc wheel	Vehicle load	Max. front axle load 2000 kg
205/75R16C 110/108R	Fully laden	-
205/75R16C 110/108R	Empty	-
225/75R16C 121/120R	Fully laden	370 kPa (3.7 bar/54 psi)
225/75R16C 121/120R	Empty	300 kPa (3.0 bar/44 psi)
225/75R16C 118/116R	Fully laden	370 kPa (3.7 bar/54 psi)
225/75R16C 118/116R	Empty	300 kPa (3.0 bar/44 psi)
235/65R16C 115/113R	Fully laden	-
235/65R16C 115/113R	Empty	-
235/65R16C 121/119R	Fully laden	380 kPa (3.8 bar/55 psi)
235/65R16C 121/119R	Empty	300 kPa (3.0 bar/44 psi)

Tyres/disc wheel	Vehicle load	Max. front axle load 2000 kg
235/65R16C 118/116R	Fully laden	380 kPa (3.8 bar/55 psi)
235/65R16C 118/116R	Empty	300 kPa (3.0 bar/44 psi)
235/60R17C 117/115R	Fully laden	400 kPa (4.0 bar/58 psi)
235/60R17C 117/115R	Empty	310 kPa (3.1 bar/45 psi)
235/60R17C 117/115S	Fully laden	400 kPa (4.0 bar/58 psi)
235/60R17C 117/115S	Empty	310 kPa (3.1 bar/45 psi)

Rear axle tyre pressures on vehicles with rear wheel drive and Single tyres
Max. rear axle load 1800 kg

Tyres/disc wheel	Vehicle load	Max. rear axle load 1800 kg
205/75R16C 110/108R	Fully laden	400 kPa (4.0 bar/58 psi)
205/75R16C 110/108R	Empty	330 kPa (3.3 bar/48 psi)
225/75R16C 121/120R	Fully laden	330 kPa (3.3 bar/48 psi)
225/75R16C 121/120R	Empty	300 kPa (3.0 bar/44 psi)
225/75R16C 118/116R	Fully laden	330 kPa (3.3 bar/48 psi)
225/75R16C 118/116R	Empty	300 kPa (3.0 bar/44 psi)
235/65R16C 115/113R	Fully laden	340 kPa (3.4 bar/49 psi)
235/65R16C 115/113R	Empty	300 kPa (3.0 bar/44 psi)
235/65R16C 121/119R	Fully laden	340 kPa (3.4 bar/49 psi)
235/65R16C 121/119R	Empty	300 kPa (3.0 bar/44 psi)
235/65R16C 118/116R	Fully laden	340 kPa (3.4 bar/49 psi)
235/65R16C 118/116R	Empty	300 kPa (3.0 bar/44 psi)
235/60R17C 117/115R	Fully laden	350 kPa (3.5 bar/51 psi)
235/60R17C 117/115R	Empty	310 kPa (3.1 bar/45 psi)
235/60R17C 117/115S	Fully laden	350 kPa (3.5 bar/51 psi)
235/60R17C 117/115S	Empty	310 kPa (3.1 bar/45 psi)

Max. rear axle load 2000 kg

Tyres/disc wheel	Vehicle load	Max. rear axle load 2000 kg
205/75R16C 110/108R	Fully laden	-
205/75R16C 110/108R	Empty	-
225/75R16C 121/120R	Fully laden	380 kPa (3.8 bar/55 psi)
225/75R16C 121/120R	Empty	300 kPa (3.0 bar/44 psi)
225/75R16C 118/116R	Fully laden	380 kPa (3.8 bar/55 psi)
225/75R16C 118/116R	Empty	300 kPa (3.0 bar/44 psi)
235/65R16C 115/113R	Fully laden	380 kPa (3.8 bar/55 psi)
235/65R16C 115/113R	Empty	300 kPa (3.0 bar/44 psi)
235/65R16C 121/119R	Fully laden	380 kPa (3.8 bar/55 psi)
235/65R16C 121/119R	Empty	300 kPa (3.0 bar/44 psi)
235/65R16C 118/116R	Fully laden	380 kPa (3.8 bar/55 psi)
235/65R16C 118/116R	Empty	300 kPa (3.0 bar/44 psi)
235/60R17C 117/115R	Fully laden	400 kPa (4.0 bar/58 psi)
235/60R17C 117/115R	Empty	310 kPa (3.1 bar/45 psi)
235/60R17C 117/115S	Fully laden	400 kPa (4.0 bar/58 psi)
235/60R17C 117/115S	Empty	310 kPa (3.1 bar/45 psi)

Max. rear axle load 2250 kg

Tyres/disc wheel	Vehicle load	Max. rear axle load 2250 kg
205/75R16C 110/108R	Fully laden	-
205/75R16C 110/108R	Empty	-
225/75R16C 121/120R	Fully laden	430 kPa (4.3 bar/62 psi)
225/75R16C 121/120R	Empty	300 kPa (3.0 bar/44 psi)
225/75R16C 118/116R	Fully laden	430 kPa (4.3 bar/62 psi)
225/75R16C 118/116R	Empty	300 kPa (3.0 bar/44 psi)
235/65R16C 115/113R	Fully laden	450 kPa (4.5 bar/65 psi)
235/65R16C 115/113R	Empty	300 kPa (3.0 bar/44 psi)
235/65R16C 121/119R	Fully laden	450 kPa (4.5 bar/65 psi)
235/65R16C 121/119R	Empty	300 kPa (3.0 bar/44 psi)

Tyres/disc wheel	Vehicle load	Max. rear axle load 2250 kg
235/65R16C 118/116R	Fully laden	450 kPa (4.5 bar/65 psi)
235/65R16C 118/116R	Empty	300 kPa (3.0 bar/44 psi)
235/60R17C 117/115R	Fully laden	460 kPa (4.6 bar/67 psi)
235/60R17C 117/115R	Empty	310 kPa (3.1 bar/45 psi)
235/60R17C 117/115S	Fully laden	460 kPa (4.6 bar/67 psi)
235/60R17C 117/115S	Empty	310 kPa (3.1 bar/45 psi)

Max. rear axle load 2430 kg

Tyres/disc wheel	Vehicle load	Max. rear axle load 2430 kg
205/75R16C 110/108R	Fully laden	-
205/75R16C 110/108R	Empty	-
225/75R16C 121/120R	Fully laden	490 kPa (4.9 bar/71 psi)
225/75R16C 121/120R	Empty	300 kPa (3.0 bar/44 psi)
225/75R16C 118/116R	Fully laden	490 kPa (4.9 bar/71 psi)
225/75R16C 118/116R	Empty	300 kPa (3.0 bar/44 psi)
235/65R16C 115/113R	Fully laden	-
235/65R16C 115/113R	Empty	-
235/65R16C 121/119R	Fully laden	490 kPa (4.9 bar/71 psi)
235/65R16C 121/119R	Empty	300 kPa (3.0 bar/44 psi)
235/65R16C 118/116R	Fully laden	490 kPa (4.9 bar/71 psi)
235/65R16C 118/116R	Empty	300 kPa (3.0 bar/44 psi)
235/60R17C 117/115R	Fully laden	500 kPa (5.0 bar/73 psi)
235/60R17C 117/115R	Empty	310 kPa (3.1 bar/45 psi)
235/60R17C 117/115S	Fully laden	500 kPa (5.0 bar/73 psi)
235/60R17C 117/115S	Empty	310 kPa (3.1 bar/45 psi)

Front axle tyre pressures on vehicles with rear wheel drive and Single tyres
Max. front axle load 1850 kg

Tyres/disc wheel	Vehicle load	Max. front axle load 1850 kg
195/75R16C 107/105R	Fully laden	440 kPa (4.4 bar/64 psi)
195/75R16C 107/105R	Empty	400 kPa (4.0 bar/58 psi)
205/75R16C 110/108R	Fully laden	410 kPa (4.1 bar/60 psi)
205/75R16C 110/108R	Empty	360 kPa (3.6 bar/52 psi)
205/75R16C 113/111R	Fully laden	-
205/75R16C 113/111R	Empty	-

Max. front axle load 2000 kg

Tyres/disc wheel	Vehicle load	Max. front axle load 2000 kg
195/75R16C 107/105R	Fully laden	-
195/75R16C 107/105R	Empty	-
205/75R16C 110/108R	Fully laden	440 kPa (4.4 bar/64 psi)
205/75R16C 110/108R	Empty	360 kPa (3.6 bar/52 psi)
205/75R16C 113/111R	Fully laden	-
205/75R16C 113/111R	Empty	-

Max. front axle load 2100 kg

Tyres/disc wheel	Vehicle load	Max. front axle load 2100 kg
195/75R16C 107/105R	Fully laden	-
195/75R16C 107/105R	Empty	-
205/75R16C 110/108R	Fully laden	-
205/75R16C 110/108R	Empty	-
205/75R16C 113/111R	Fully laden	480 kPa (4.8 bar/70 psi)
205/75R16C 113/111R	Empty	380 kPa (3.8 bar/55 psi)

Rear axle tyre pressures on vehicles with rear wheel drive and twin tyres
Max. rear axle load 3200 kg

Tyres/disc wheel	Vehicle load	Max. rear axle load up to 3200 kg
195/75R16C 107/105R	Fully laden	410 kPa (4.1 bar/60 psi)
195/75R16C 107/105R	Empty	350 kPa (3.5 bar/51 psi)
205/75R16C 110/108R	Fully laden	370 kPa (3.7 bar/54 psi)
205/75R16C 110/108R	Empty	320 kPa (3.2 bar/46 psi)
205/75R16C 113/111R	Fully laden	-
205/75R16C 113/111R	Empty	-

Max. rear axle load 3500 kg

Tyres/disc wheel	Vehicle load	Max. rear axle load 3500 kg
195/75R16C 107/105R	Fully laden	440 kPa (4.4 bar/64 psi)
195/75R16C 107/105R	Empty	350 kPa (3.5 bar/51 psi)
205/75R16C 110/108R	Fully laden	410 kPa (4.1 bar/60 psi)
205/75R16C 110/108R	Empty	320 kPa (3.2 bar/46 psi)
205/75R16C 113/111R	Fully laden	-
205/75R16C 113/111R	Empty	-

Max. rear axle load 3600 kg

Tyres/disc wheel	Vehicle load	Max. rear axle load 3600 kg
195/75R16C 107/105R	Fully laden	-
195/75R16C 107/105R	Empty	-
205/75R16C 110/108R	Fully laden	-
205/75R16C 110/108R	Empty	-
205/75R16C 113/111R	Fully laden	430 kPa (4.3 bar/62 psi)
205/75R16C 113/111R	Empty	340 kPa (3.4 bar/49 psi)

Front axle tyre pressures on vehicles with rear wheel drive and Super Single tyres
Max. front axle load 1850 kg

Tyres/disc wheel	Vehicle load	Max. front axle load 1850 kg
225/75R16C 121/120R (122L)	Fully laden	340 kPa (3.4 bar/49 psi)
225/75R16C 121/120R (122L)	Empty	300 kPa (3.0 bar/44 psi)

Max. front axle load 2000 kg

Tyres/disc wheel	Vehicle load	Max. front axle load 2000 kg
225/75R16C 121/120R (122L)	Fully laden	370 kPa (3.7 bar/54 psi)
225/75R16C 121/120R (122L)	Empty	300 kPa (3.0 bar/44 psi)

Rear axle tyre pressures on vehicles with rear wheel drive and Super Single tyres
Max. rear axle load 3200 kg

Tyres/disc wheel	Vehicle load	Max. rear axle load up to 3200 kg
225/75R16C 121/120R (122L)	Fully laden	690 kPa (6.9 bar/100 psi) ²⁾
225/75R16C 121/120R (122L)	Empty	690 kPa (6.9 bar/100 psi) ²⁾
285/65R16C 131R	Fully laden	460 kPa (4.6 bar/67 psi)
285/65R16C 131R	Empty	400 kPa (4.0 bar/58 psi)

²⁾ Valid to use for a short time as a spare wheel on the rear axle for a maximum distance of 100 km and a maximum speed of 55 km/h.

Max. rear axle load 3500 kg

Tyres/disc wheel	Vehicle load	Max. rear axle load 3500 kg
225/75R16C 121/120R (122L)	Fully laden	690 kPa (6.9 bar/100 psi) ²⁾
225/75R16C 121/120R (122L)	Empty	690 kPa (6.9 bar/100 psi) ²⁾
285/65R16C 131R	Fully laden	520 kPa (5.2 bar/75 psi)
285/65R16C 131R	Empty	400 kPa (4.0 bar/58 psi)

²⁾ Valid to use for a short time as a spare wheel on the rear axle for a maximum distance of 100 km and a maximum speed of 55 km/h.

Be sure to also observe the following further related subjects:

- notes on tyre pressure (→ page 313)

Tyre pressure monitor

Function of tyre pressure monitor on Single tyres

The system checks the tyre pressure and the temperature of the tyres fitted to the vehicle by means of a tyre pressure sensor.

New tyre pressure sensors, e.g. in winter tyres, are automatically taught-in the first time they are driven.

The tyre pressure and the tyre temperature appear in the multifunction display (→ page 182).

If there is a substantial loss of tyre pressure, a warning is issued:

- via display messages (→ page 375)
- via the  warning lamp in the instrument cluster

It is the driver's responsibility to set the tyre pressure to the recommended cold tyre pressure suitable for the operating situation. Set the tyre pressure for cold tyres using a tyre pressure gauge. Note that the correct tyre pressure for the current operating situation must first be taught-in to the tyre pressure monitoring system.

In most cases, the tyre pressure monitoring system will automatically update the new reference values after you have changed the tyre pressure. You can, however, also update the reference values by restarting the tyre pressure monitoring system manually (→ page 329).

System limitations

The system may be impaired or may not function in the following situations:

- if the tyre pressure is set incorrectly
- if there is a sudden pressure loss caused by a foreign object penetrating the tyre, for example
- if there is a malfunction caused by another radio signal source

Make sure to observe the following further related subject:

- Notes on tyre pressure (→ page 313)

Checking the tyre pressure with the tyre pressure monitoring system

Requirements:

- the ignition is switched on

On-board computer:

 [Service](#)  [Tyres](#)

One of the following displays appears:

- the current tyre pressure and tyre temperature of the individual wheels

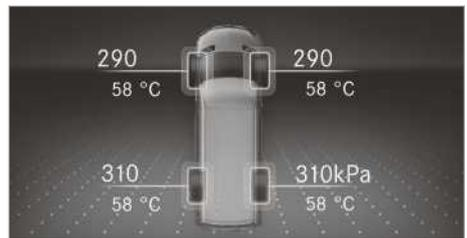

Instrument display with colour display

- the current tyre pressure for each wheel

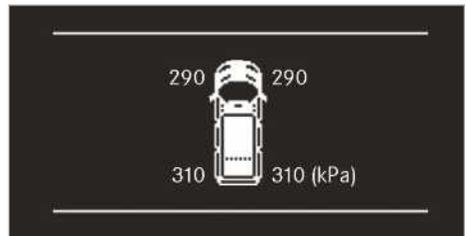

Instrument display with black and white display

- **Tyre pressures will be displayed after a few minutes of driving:** the teach-in process of the system is not yet complete. The tyre pressures are already being monitored.

 Compare the tyre pressure with the recommended tyre pressure for the current operating condition. Observe the notes on tyre temperature (→ page 313).

- i** The values displayed in the multifunction display may deviate from those of the tyre pressure gauge as they refer to sea level. At high altitudes, the tyre pressure values indicated by a pressure gauge are higher than those shown by the on-board computer. In this case, do not reduce the tyre pressures.

Make sure to observe the following further related subject:

- Notes on tyre pressure (→ page 313)

Restarting the tyre pressure monitor

Requirements:

- The recommended tyre pressure is correctly set for the respective operating condition on each of the wheels (→ page 313).
- **Restart the tyre pressure monitoring system in the following situations:**
 - The tyre pressure has changed.
 - The wheels or tyres have been changed or newly fitted.

On-board computer:

↳ Service ▶ Tyres

- ▶ Scroll down in the menu. The **Use current pressures as new reference values?** message appears in the multifunction display.
- ▶ Confirm the message to initiate a restart. The **Tyre press. monitor restarted** message appears in the multifunction display. Current warning messages are deleted and the  yellow warning lamp goes out. After you have driven for a few minutes, the system checks whether the current tyre pressures are within the specified range. The current tyre pressures are then accepted as reference values and monitored.

Make sure to observe the following further related subject:

- Notes on tyre pressure (→ page 313)

Radio-equipment approval of the tyre pressure monitoring system

Radio equipment approval numbers

Country	Radio equipment approval number
Argentina	 CNC ID: H-20027
Australia	
Brazil	 MODELO: TSSRE4A ANATEL: 05181-17-06643 Este equipamento opera em caráter secundário, isto é, não tem direito à proteção contra interferência prejudicial, mesmo de estações do mesmo tipo e não pode causar interferência a sistemas operando em caráter primário.
Canada	IC: 4008C-TSSRE4A Operation is subject to the following two conditions: (1) this device may not cause harmful interference, and (2) this device must accept any interference received, including interference that may cause undesired operation.

Country	Radio equipment approval number
European Union Iceland Norway	 <p>Huf Hülsbeck & Fürst GmbH & Co. KG hereby declare that the two-way radio system type TSSRE4A & TSSSG4G6 conforms to the directive 2014/53/EU.</p> <p>The complete text of the EU declaration of conformity is available at the following internet address: http://www.huf-group.com/eudoc</p> <p>Waveband: 433.92 MHz Maximum transmission output emitted: <10 mW Manufacturer: Huf Electronics Bretten GmbH Gewerbestr. 40 75015 Bretten Germany</p>
Indonesia	TSSRE4A & TSSSG4G6 52166/SDPPI/2017 3533
Israel	<p>A. The use of this product does not need a wireless operation license.</p> <p>B. The product does not include an RF disturbance protection, and should not disturb other licensed products.</p> <p>C. It is forbidden to replace the antenna or to make any change in this product.</p>

Country	Radio equipment approval number
Jordan	<p>Kingdom of Jordan Type approval for Tyre Pressure Sensor and ECU</p> <p>Manufacturer: Huf Electronics Bretten GmbH Model: TSSRE4A Type Approval Number: TRC/LPD/2017/421 Model: TSSSG4G6 Type Approval Number: TRC/LPD/2017/422</p>
Malaysia	 <p>CIDF17000184 Model: TSSRE4A & TSSSG4G6 RAQP/57A/0817/S(17-2424)</p>
Morocco	<p>AGREE PAR L'ANRT MAROC Modele: TSSRE4A Numero d'agrement: MR 14320 ANRT 2017 Date d'agrement: 07/07/2017 Modele: TSSSG4G6 Numero d'agrement: MR 14319 ANRT 2017 Date d'agrement: 07/07/2017</p>
Mexico	Model: TSSRE4A, IFETEL: RLVHUTS 17-0806
Moldova	
Oman	OMAN - TRA R/4516/17 D100428
Philippines	 <p>NTC Type Approved. No: ESD-1715393C</p>

Country	Radio equipment approval number
Russia	
Singapore	Complies with IDA Standards DA 103787
South Africa	 TA-2017/1393 TA-2017/1391
South Korea	 R-CRM-HHF-TSSRE4A R-REM-HHF-TSSSG4G6 Applicant name: Huf Hülsbeck & Fürst GmbH & Co. KG Equipment name: Tire Pressure Monitoring System Manufacturing Year/Month: on the product Manufacturer: Huf Electronics Bretten GmbH Country of origin: Germany 해당 무선 설비 기기는 운용 중 전파혼신 가능성이 있으므로 인명안전과 관련된 서비스는 할 수 없음. (This device is not allowed to provide service related human body since it has possibility of frequency interference during on operation.)

Country	Radio equipment approval number
Taiwan	 CCAO17LP0380T4 CCAO17LP0390T7 經型式認證合格之低功率射頻電機,非經許可,公司、商號或使用者均 不得擅自變更頻率、加大功率或變更原設計之特性及功能。 低功率射 頻電機之使用不得影響飛航安全及干擾合法通信;經發現有干擾現象 時,應立即停用,並改善至無干擾時方得繼續使用。前項合法通信,指依 電信法規定作業之無線電通信。低功率射頻電機須忍受合法通信或工 業、科學及醫療用電波輻射性電機設備之干擾。 According to “Administrative Regulations on Low Power Radio Waves Radiated Devices”. Without permission granted by the DGT, any company, enterprise, or user is not allowed to change frequency, enhance transmitting power or alter original characteristic as well as performance to a approved low power radio-frequency devices. The low power radio-frequency devices shall not influence aircraft security and interfere legal communications; If found, the user shall cease operating immediately until no interference is achieved. The said legal communications means radio communications is operated in compliance with the Telecommunications Act. The low power radio-frequency devices must be susceptible with the interference from legal com-

Country	Radio equipment approval number
	munications or ISM radio wave radiated devices.
Thailand	This telecommunication equipment conforms to NTC technical requirement.
Ukraine	 <p>Model: TSSRE4A & TSSSG4G6 UA.TR.109.0109-17</p>
United Arab Emirates	<p>Huf Electronics Bretten GmbH Model: TSSRE4A Model: TSSSG4G6 TRA Registered No: ER57807 / 17 Dealer No: DA36976 / 14 TRA Registered No: ER57806 / 17 Dealer No: DA36976 / 14</p>
USA	<p>FCC ID: YGOTSSRE4A</p> <p>This device complies with Part 15 of the FCC Rules. Operation is subject to the following two conditions: (1) this device may not cause harmful interference, and (2) this device must accept any interference received, including interference that may cause undesired operation.</p> <p>WARNING: Any changes or modification not expressly approved by the party responsible for compliance could void the user's authority to operate this equipment.</p>

Changing a wheel

Notes on selecting, fitting and replacing tyres

You can ask for information regarding permitted wheel/tyre combinations at a qualified specialist workshop.

⚠ WARNING Risk of accident due to incorrect sizes of wheels and tyres

If wheels and tyres of the wrong size are used, the wheel brakes or wheel suspension components may be damaged.

▶ Always replace wheels and tyres with ones that fulfil the specifications of the original part.

For wheels, pay attention to the following:

- Designation
- Type
- Permissible wheel load
- Wheel offset

For tyres, pay attention to the following:

- Designation
- Manufacturer
- Type
- Load-bearing index
- Speed rating

⚠ WARNING Risk of injury through exceeding the specified tyre load-bearing capacity or the permissible speed rating

Exceeding the specified tyre load-bearing capacity or the permissible speed rating may lead to tyre damage and to the tyres bursting.

- ▶ Therefore, only use tyre types and sizes approved for your vehicle model.
- ▶ Observe the tyre load-bearing capacity rating and speed rating required for your vehicle.

! **NOTE** Vehicle and tyre damage through tyre types and sizes that have not been approved

For safety reasons, only use tyres, wheels and accessories which have been specially approved by Mercedes-Benz for your vehicle.

These tyres have been specially adapted for use with the control systems, such as ABS or ESP®.

Otherwise, certain properties, such as handling characteristics, vehicle noise and consumption could be adversely affected. Furthermore, other tyre sizes could result in the tyres rubbing against the body and axle com-

ponents when loaded. This could result in damage to the tyre or the vehicle.

- ▶ Only use tyres, wheels and accessories that have been checked and recommended by Mercedes-Benz.

! **NOTE** Driving safety put at risk by retreaded tyres

Retreaded tyres are not checked or recommended by Mercedes-Benz, as previous damage is not always detected during the retread process.

Driving safety cannot, therefore, be guaranteed.

- ▶ Do not use used tyres when their previous usage is unknown.

! **NOTE** Damage to electronic component parts through the use of tyre-fitting tools

Vehicles with tyre pressure monitoring system: there are electronic component parts in the wheel. Tyre-fitting tools should not be applied in the area of the valve.

Otherwise, the electronic component parts could be damaged.

- ▶ Always have tyres changed at a qualified specialist workshop.

Accessories that are not approved for your vehicle by Mercedes-Benz, or are not being used correctly, can impair operating safety.

Before purchasing and using non-approved accessories, visit a qualified specialist workshop and enquire about:

- suitability
- legal stipulations
- factory recommendations

Observe the following points when selecting, fitting and replacing tyres:

- Country-specific requirements for tyre approval that define a specific tyre type for your vehicle.

Furthermore, the use of certain tyre types in certain regions and areas of operation can be highly beneficial.

- Use only tyres and wheels of the same type, design (summer tyres, winter tyres, all-season tyres) and make.

- Only fit wheels of the same size and tread design on one axle (left and right).

It is only permissible to fit a different wheel size to this in the event of a flat tyre in order to drive to the specialist workshop.

- Only fit tyres of the correct size onto the wheels.
- Do not make any modifications to the brake system, the wheels or the tyres.

The use of wheel spacers or brake dust shields is not permitted and results in the invalidation of the vehicle's general operating permit.

- **Vehicles with a tyre pressure monitoring system:** all fitted wheels must be equipped with functioning sensors for the tyre pressure monitoring system.

- At temperatures below 10 °C, use winter tyres or all-season tyres marked M+S for all wheels.

Winter tyres bearing the  snowflake symbol in addition to the M+S marking provide the best possible grip in wintry road conditions.

- For M+S tyres, only use tyres with the same tread.
- Observe the maximum permissible speed for the M+S tyres fitted.

If this is below the vehicle's maximum speed, this must be indicated in an appropriate label in the driver's field of vision.

- Run in new tyres at moderate speeds for the first 100 km.
- Replace the tyres after six years at the latest, regardless of wear.

For more information on wheels and tyres, contact a qualified specialist workshop.

Be sure to also observe the following further related subjects:

- Notes on tyre pressure (→ page 313)
- Tyre pressure table
- Notes on the emergency spare wheel (→ page 341)

Notes on changing wheels

▲ WARNING Risk of injury through different wheel sizes

Interchanging the front and rear wheels if the wheels or tyres have different dimensions may severely impair the driving characteristics.

The disk brakes or wheel suspension components may also be damaged.

▶ Rotate front and rear wheels only if the wheels and tyres are of the same dimensions.

Interchanging the front and rear wheels if the wheels or tyres have different dimensions can render the general operating permit invalid.

On vehicles with the same front and rear wheel size, you can interchange the wheels every 5,000 to 10,000 km depending on the wear. Ensure the direction of rotation is maintained for the wheels.

It is imperative to observe the instructions and safety notes on "Changing a wheel" when doing so.

Wheel size categories of wheels

The determined vehicle speed is displayed in the instrument cluster and is important for controlling the driving safety systems and driving systems. The display accuracy of the speedometer and the odometer is legally prescribed. Determining the speed is dependent on the tyre size or the rolling circumference of the tyres. The rim diameter is always specified in inches.

For this reason, the vehicle control units can be coded for the following three wheel size categories:

Wheel size category 1

- 195/75 R16C
- 205/75 R16C
- 225/65 R16C
- 235/65 R16C
- 235/60 R17C

Wheel size category 2

- 225/75 R16C

Wheel size category 3

- 225/75 R16C FA
- 285/65 R16C RA

- ① Mercedes-Benz recommends that you stay within a wheel size category when changing a tyre. In this way, you avoid recoding the control units.

If you change the wheel size of your vehicle, for instance when changing wheels for winter operation, check it is assigned to the correct wheel size category. If the wheel size category changes, you must have your vehicle's control units recoded at a qualified specialist workshop.

Otherwise, the display accuracy of the speedometer and the odometer will be outside the legally prescribed tolerance. It may also be lower, i.e. the current road speed is then higher than the speed shown on the speedometer. If a deviation is outside the range of tolerance, driving safety systems and driving systems may be operationally impaired or may detect a malfunction and switch themselves off.

Information on the direction of the tyres' rotation

Tyres with a specified direction of rotation have additional benefits, e.g. if there is a risk of aquaplaning. You will only gain these benefits if the correct direction of rotation is observed.

An arrow on the sidewall of the tyre indicates its correct direction of rotation.

You may also fit a spare wheel against the direction of rotation. Observe the time restriction on use as well as the speed limitation specified on the spare wheel.

Information on storing wheels

Observe the following when storing wheels:

- Wheels that have been removed should be stored in a cool, dry and, if possible, dark place.
- Protect the tyres from oil, grease and fuel.

Overview of the tyre-change tool kit

Necessary tyre-change tool kit may include, for example:

- jack
- wheel spanner

- ① You will find the maximum load capacity of the jack stated on the adhesive label attached to the jack.

The jack is maintenance-free. If there is a malfunction, please contact a qualified specialist workshop.

Vehicles with rear wheel drive

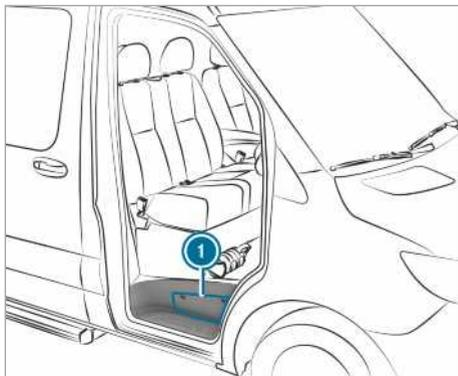

The tyre-change tool kit (1) is located in the stowage compartment above the step of the co-driver's door and in the stowage compartment in the footwell on the co-driver side.

Vehicles with front wheel drive



The tyre-change tool kit (1) is located behind the driver's seat.

Preparing the vehicle for a wheel change

Requirements:

- The tyre-change tool kit is available.
 - The vehicle is not on a slope.
 - The vehicle is on solid, non-slippery and level ground.
- ▶ apply the parking brake.
 - ▶ Move the front wheels to the straight-ahead position.
 - ▶ **Vehicles with manual transmission:** engage first or reverse gear **[R]**.

- ▶ **Vehicles with automatic transmission:** shift the transmission to position **[P]**.
- ▶ Switch off the engine.
- ▶ Make sure that the engine cannot be started.
- ▶ Take the vehicle tool kit from the footwell on the co-driver side (→ page 309).

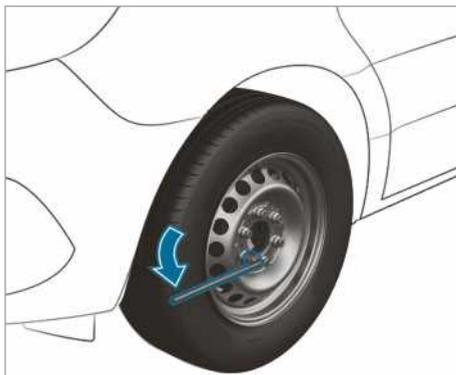

Vehicles with rear wheel drive

- ▶ Take the jack and the tyre-change tool kit out of the stowage compartment (→ page 334).
- ▶ If necessary, remove the hub cap.
- ▶ Assemble the wheel wrench extension using the middle rod and the rod with the largest diameter from the three-piece jack pump lever.
- ▶ Starting with the middle rod, slide the wheel wrench extension as far as it will go onto the wheel wrench.
- ▶ Using the wheel wrench, loosen the wheel nuts or bolts on the wheel you wish to change by about one full turn. Do not unscrew the wheel nuts or bolts completely.
- ▶ Raise the vehicle (→ page 336).

Vehicles with front wheel drive

- ▶ Take the jack and the tyre-change tool kit from behind the driver's seat (→ page 334).
- ▶ If necessary, remove the hub cap.
- ▶ Using the wheel wrench, loosen the wheel nuts/bolts on the wheel you wish to change by about one full turn. Do not unscrew the wheel bolts/nuts completely.
- ▶ Raise the vehicle (→ page 336).

Raising the vehicle when changing a wheel

▲ WARNING Risk of injury from jack tipping

If you park a vehicle with air suspension, the air suspension may remain activated for up to one hour, even when the ignition is switched off. If you then raise the vehicle with the jack, the air suspension will attempt to adjust the vehicle level.

The jack may tip.

- ▶ Press the Service button on the air suspension remote control before raising the vehicle. This prevents automatic readjustment of the vehicle level and prevents it from being raised or lowered manually.

▲ WARNING Risk of injury from incorrect positioning of the jack

If you do not position the jack correctly at the appropriate jacking point of the vehicle, the jack could tip with the vehicle raised.

- ▶ Only position the jack at the appropriate jacking point of the vehicle. The base of the jack must be positioned vertically under the jacking point of the vehicle.

▲ WARNING Risk of injury from vehicle tipping

On slopes, the jack could tip with the vehicle raised.

- ▶ Never change a wheel on a slope.
- ▶ Consult a qualified specialist workshop.

! NOTE Vehicle damage from the jack

If you do not position the jack correctly at the appropriate jack support point of the vehicle, the jack could tip over with the vehicle raised.

- ▶ The jack is designed exclusively for jacking up the vehicle at the jack support points.

Requirements:

- There are no persons in the vehicle.
- The vehicle is prepared for changing a wheel (→ page 335).

Only position the jack on the jack support points intended for this purpose. You could otherwise damage the vehicle.

Important notes on using the jack:

- Only use the vehicle-specific jack that has been tested and approved by Mercedes-Benz to raise the vehicle. If the jack is used incorrectly, it could tip over while the vehicle is raised.
- The jack is designed only to raise the vehicle for a short time while a wheel is being changed and is not suitable for carrying out maintenance work under the vehicle.
- Avoid changing a wheel on uphill and downhill slopes.
- The jack must be placed on a firm, flat and non-slip surface. If necessary, use a large, flat, load bearing and non-slip underlay.
- The base of the jack is positioned vertically under the jack support point.

Safety instructions while the vehicle is raised:

- Do not put your hands or feet under the vehicle.
- Do not lie underneath the vehicle.
- Do not start the engine and do not release the parking brake.
- Do not open or close any doors.

Vehicles with front wheel drive

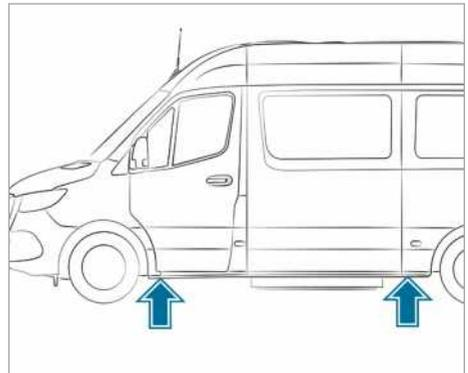

Jack support points

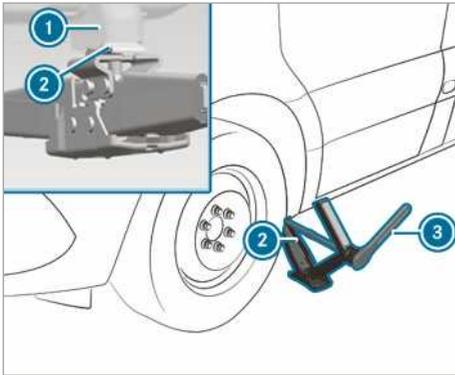

Jack support point, front axle

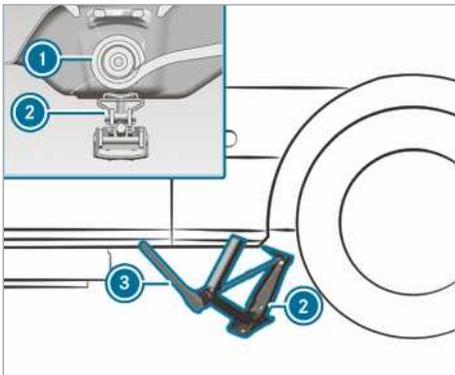

Jack support point, rear axle

- ▶ If necessary, turn the head of the jack.
- ▶ Position jack (2) at jack support point (1).
- ▶ Turn the handwheel until the plate of the jack sits securely on jack support point (1).
- ▶ **Front axle:** position ratchet ring spanner (3) from the tyre-change tool kit on the hexagon nut of the jack so that the lettering "AUF" is visible.
- ▶ **Rear axle:** position the extension rod and the socket wrench from the tyre-change tool kit on the hexagon nut of the jack and position ratchet ring spanner (3) from the tyre-change tool kit on the extension rod until the lettering "AUF" is visible.
- ▶ Turn ratchet ring spanner (3) clockwise until jack (2) sits completely on jack support point (1) and the base of the jack lies evenly on the ground.

- ▶ Turn ratchet ring spanner (3) until the tyre is raised a maximum of 3 cm off the ground.
- ▶ Loosen and remove the wheel (→ page 338).

Vehicles with rear wheel drive

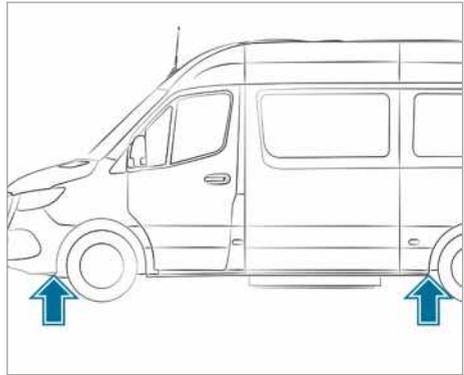

Jack support points

Only use the middle rod and the pump lever rod with the largest diameter for the jack as a wheel wrench extension. Only insert the middle rod on the wheel wrench, and always as far as it will go. Otherwise, the rods could bend and deform so much that they can no longer be used as pump levers for the jack.

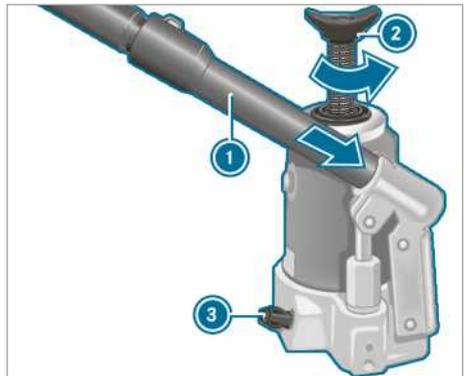

- ▶ **To prepare the hydraulic jack:** insert the third rod of pump lever (1) for the jack into the wheel wrench extension.
- ▶ Close pressure release screw (3).
- ▶ To do this, use the flattened section on pump lever (1) to turn pressure release screw (3) clockwise to the stop.

i Do not turn pressure release screw **3** more than one or two full turns. Hydraulic fluid could otherwise escape.

- ▶ Insert pump lever **1** with the largest rod into the recess on the jack and secure by turning it clockwise.
- ▶ Place the jack vertically beneath the jack support points described below.

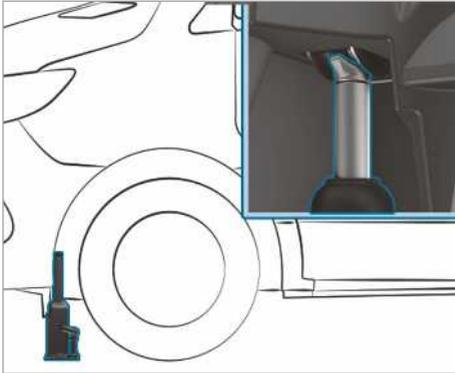

Jack support point, front axle

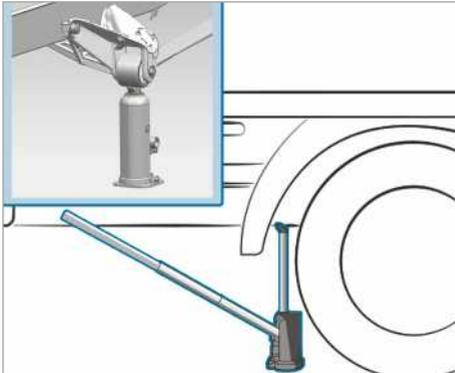

Jack support point, rear axle (example: platform vehicle up to 3.5 t)

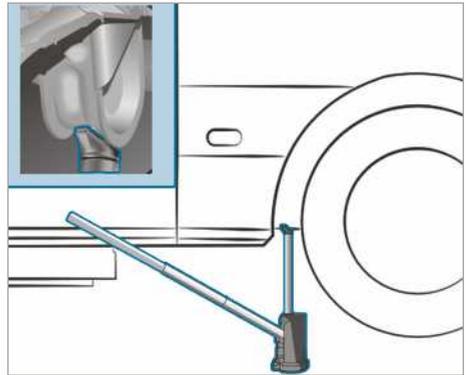

Jack support point, rear axle (example: panel van and crewbus up to 4.0 t)

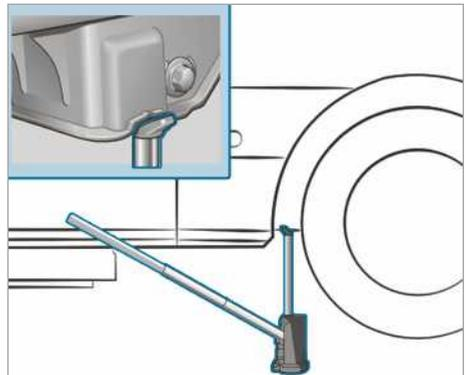

Jack support point, rear axle (vehicles 5.0 t)

- ▶ Place the jack beneath the jack support point.
- ▶ **Vehicles with all-wheel drive:** turn jack spindle **2** anti-clockwise as far as it will go.
- ▶ Raise the vehicle until the tyre is raised a maximum of 3 cm off the ground.
- ▶ Loosen and remove the wheel (→ page 338).

Removing a wheel

Requirements:

- The vehicle is raised (→ page 336).

When changing a wheel, avoid applying any force to the brake discs since this could impair the level of comfort when braking.

NOTE Damage to threading from dirt on wheel bolts

Do not place wheel bolts in sand or on a dirty surface.

- ▶ Unscrew the wheel bolts or nuts with the wheel nut wrench.
- ▶ On front wheels with wheel nuts, remove the wheel nut cover.
- ▶ Remove the wheel.

Fitting a new wheel

Requirements:

- The wheel is removed (→ page 338).

WARNING Risk of accident from losing a wheel

Oiled, greased or damaged wheel bolt/wheel nut threads or wheel hub/wheel mounting bolt threads can cause the wheel bolts/wheel nuts to come loose.

As a result, you could lose a wheel while driving.

- ▶ Never oil or grease the threads.
- ▶ In the event of damage to the threads, contact a qualified specialist workshop immediately.
- ▶ Have the damaged wheel bolts or damaged hub threads replaced.
- ▶ Do not continue driving.

WARNING Risk of injury from tightening wheel bolts and nuts

If you tighten the wheel bolts or wheel nuts when the vehicle is raised, the jack could tip.

- ▶ Only tighten wheel bolts or wheel nuts when the vehicle is on the ground.
- ▶ Observe the information on the choice of tyres (→ page 332).
- ▶ For safety reasons, only use wheel bolts or wheel nuts which have been approved by Mercedes-Benz and for the wheel in question.

When you fit the steel spare wheel, it is essential you use short wheel bolts for a steel wheel. Using other wheel bolts when fitting the steel spare wheel may lead to damage to the brake system.

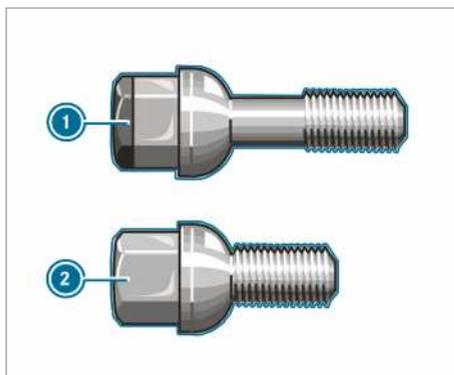

- ① Wheel bolt for light-alloy wheel
- ② Wheel bolt for steel wheel

- ▶ Clean the wheel and wheel hub contact surfaces.
- ▶ **Vehicles with Super Single tyres:** first fit the adapter for the narrow spare wheel on the wheel hub.
- ▶ Slide the wheel which is to be refitted onto the wheel hub or the adapter for the spare wheel and push it on.
- ▶ Slide the wheel which is to be refitted onto the wheel hub and push it on.

Wheels centred using the wheel bolts:

- ▶ Vehicles with light-alloy wheels: use the short wheel bolts for the steel spare wheel from the vehicle tool kit.
- ▶ Screw in the wheel bolts until they are finger-tight.

Wheels with wheel nuts:

- ▶ Front wheels with wheel nut cover: press the wheel nut cover onto the wheel nuts.
- ▶ Screw in three wheel nuts over the fixing discs of the wheel nut cover.
- ▶ Turn the wheel so that the wheel bolts are in the middle of the holes.
- ▶ Screw in the remaining wheel nuts.
- ▶ Slightly tighten all the wheel nuts.

Lowering the vehicle after a wheel change

⚠ WARNING Risk of injury through incorrect tightening torque

The wheels could come loose if the wheel bolts or wheel nuts are not tightened to the prescribed tightening torque.

- ▶ Make sure the wheel bolts or wheel nuts are tightened to the prescribed tightening torque.
- ▶ If you are not sure, do not move the vehicle. Consult a qualified specialist workshop and have the tightening torque checked immediately.

Requirements:

- The new wheel has been fitted (→ page 339).

Observe the notes on raising the vehicle (→ page 336).

Vehicles with front wheel drive

- ▶ **Front axle:** position ratchet ring spanner from the tyre-change tool kit on the hexagon nut of the jack so that the lettering "AB" is visible.
- ▶ **Rear axle:** position the extension rod from the tyre-change tool kit on the hexagon nut of the jack and position ratchet ring spanner from the tyre-change tool kit on the extension rod until the lettering "AB" is visible.
- ▶ **To lower the vehicle:** turn the ratchet ring spanner of the jack anti-clockwise.

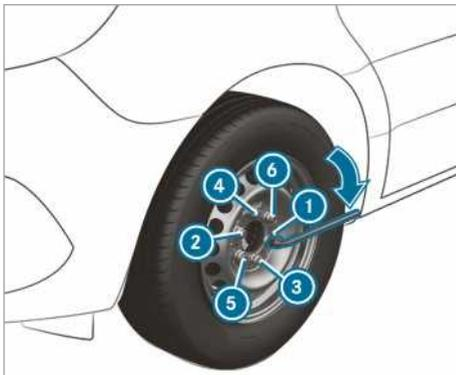

- ▶ Tighten the wheel bolts or nuts evenly in the sequence indicated (1 to 6).

Specified tightening torque:

- Steel wheel bolts: 240 Nm
- Wheel nuts: 180 Nm
- Light-alloy wheel bolts: 180 Nm

Vehicles with rear wheel drive

Only use the middle rod and the pump lever rod with the largest diameter for the jack as a wheel wrench extension. Only insert the middle rod on the wheel wrench, and always as far as it will go. Otherwise, the rods could bend and deform so much that they can no longer be used as pump levers for the jack.

Vehicles with Super Single tyres: if you mount the spare wheel to the rear axle, do not exceed the maximum speed of 55 km/h and the maximum distance of 100 km. Otherwise, the transmission could be damaged due to the different rotational speeds of the wheels.

- ▶ Using the pump lever, slowly turn the drain screw on the jack approximately one revolution and carefully lower the vehicle.
- ▶ Place the jack to one side.
- ▶ Pull the rod with the smallest diameter off the pump lever. The shortened pump lever serves as a wheel wrench extension.
- ▶ Starting with the middle rod, slide the wheel wrench extension as far as it will go onto the wheel wrench.

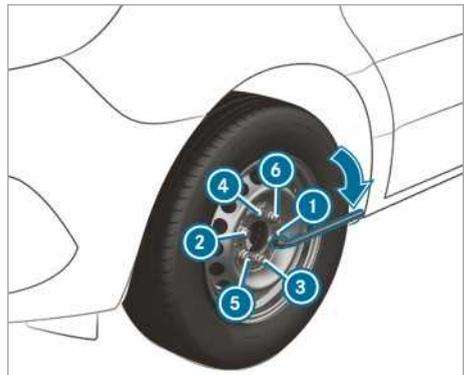

▶ Tighten the wheel bolts or nuts evenly in the sequence indicated (❶ to ❷).

Specified tightening torque:

- Steel wheel bolts: 240 Nm
- Wheel nuts: 180 Nm
- Light-alloy wheel bolts: 180 Nm

▶ Push the piston on the hydraulic jack in again and close the pressure release screw.

▶ **Vehicles with all-wheel drive:** turn the jack spindle clockwise as far as it will go.

❶ You can now fit the hub caps on steel wheels with wheel bolts. The fitting procedure depends on whether the hub cap acts as a trim that covers the whole wheel, or just covers the centre.

▶ Wheel with hub cap: position the opening for the tyre valve in the hub cap over the tyre valve.

▶ Push the edge of the hub cap onto the wheel rim with both hands until it engages into place. Make sure the hub cap retaining catches engage on the steel wheel.

▶ **Wheel with central hub cap:** position the retaining lugs of the central hub cap over the wheel bolts.

▶ Hit the middle of the hub cap to engage it on the wheel.

▶ Secure the faulty wheel in the spare wheel bracket.

▶ **Vehicles with Super Single tyres:** transport the defective rear wheel in the load area. The rear wheel is too large for the spare wheel bracket.

▶ Check the tyre pressure of the newly fitted wheel and adjust it if necessary.

▶ Retighten the wheel bolts or wheel nuts to the specified tightening torque after the vehicle has been driven 50 km.

▶ When using a wheel or spare wheel with a new or newly painted wheel rim, have the wheel bolts or nuts retightened after approximately 1,000 km to 5,000 km.

❶ **Vehicles with the tyre pressure monitor system:** all fitted wheels must be equipped with functioning sensors.

Make sure to observe the following further related subject:

- Notes on tyre pressure (→ page 313)

Spare wheel

Notes on the spare wheel

⚠ WARNING Risk of accident caused by incorrect wheel and tyre dimensions

Wheel and tyre dimensions as well as the type of tyre may vary between the spare wheel and the wheel to be replaced. When the spare wheel is fitted, driving characteristics may be severely affected.

To prevent hazardous situations:

- ▶ Adapt your driving style accordingly and drive carefully.
- ▶ Never fit more than one spare wheel that differs from the wheel to be replaced.
- ▶ Only use the spare wheel that differs from the wheel to be replaced for a short time.
- ▶ Do not switch off ESP®.
- ▶ Have the spare wheel of a different size replaced at the nearest qualified specialist workshop. The wheel and tyre must have the correct dimensions and the tyre must be the correct type.

Do not exceed a maximum speed of 80 km/h if a spare wheel of a different size is fitted.

⚠ WARNING Risk of accident from damaged spare wheel with Super Single tyres

Vehicles with Super Single tyres

The tyre of the spare wheel is under above-average strain after being fitted on the rear axle. If you exceed the maximum speed or the maximum distance, or fit the spare wheel again, the tyre of the spare wheel may be damaged. The tyre damage may not be visible and not detectable.

A damaged tyre may cause a loss of tyre pressure. This could cause you to lose control of the vehicle.

- ▶ Only use the spare wheel if it has not yet been fitted on the rear axle with the current tyres.
- ▶ If the spare wheel had been fitted on the rear axle, have the tyre of the spare wheel replaced after changing the wheel again, irrespectively of the distance.

- ▶ For safety reasons, when changing a tyre ensure that only the tyre valve type approved for the tyres is used.

! NOTE Damage to the transmission

Vehicles with Super Single tyres: when you fit the spare wheel on the rear axle, the transmission may be damaged by the different rotational speeds of the wheels.

- ▶ When the spare wheel is fitted on the rear axle, observe the maximum speed of 55 km/h and the maximum driving distance of 100 km.

- (i) The spare wheel can be used without restrictions on the front axle of a vehicle with Super Single tyres.

Regularly check that the spare wheel is secured and has the specified tyre pressure (→ page 313).

Regularly check the following, particularly prior to long trips:

- the tyre pressure of the spare wheel (if necessary, adjust the tyre pressure)
- the fastenings of the spare wheel bracket.

Replace the tyres after six years at the latest, regardless of wear. This also applies to the spare wheel.

- (i) If you have fitted a spare wheel, the tyre pressure monitoring system will not function for this wheel. The spare wheel is not equipped with a sensor for the tyre pressure monitoring system.

Fitting/removing the spare wheel

Vehicles with front wheel drive: removing the spare wheel

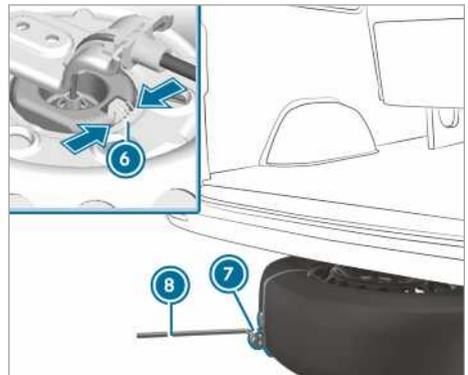
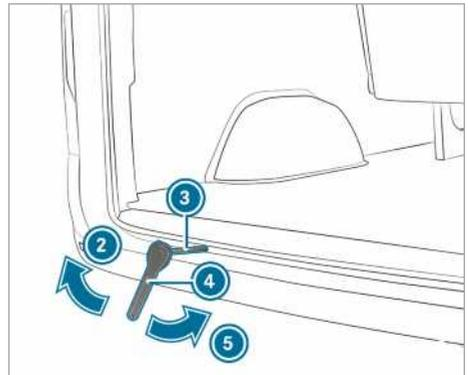
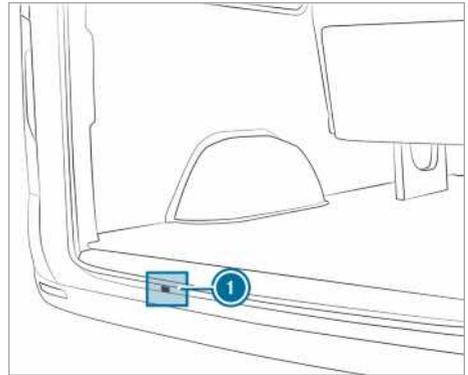

- ▶ Open the rear-end doors.

- ▶ Take ratchet ring spanner ④ and auxiliary tool ③ for the spare wheel lifter out of the vehicle tool kit.
- ▶ Push auxiliary tool ③ through opening ① into the winch guide.
- ▶ Place ratchet ring spanner ④ onto auxiliary tool ③ for the spare wheel lifter so that the letters "AB" are visible.
- ▶ Turn ratchet ring spanner ④ in the direction of arrow ② until you feel resistance or until the friction clutch of the winch overwinds.
- ▶ Hook wheel wrench ⑧ into the loop of extraction device ⑦ on the spare wheel and pull the spare wheel out from under the vehicle.
- ▶ Press spring ⑥ together on the wheel gripper and release the wheel gripper from the spare wheel.
- ▶ Remove spare wheel extraction device ⑦ and store it in a safe place.

Check that the spare wheel is correctly and firmly positioned:

- after every wheel change
- at every maintenance interval
- at least once a year

Vehicles with front wheel drive: fitting the spare wheel

- ① Light-alloy wheels cannot be transported under the vehicle. In this case, transport the light-alloy wheel in the load compartment.
- ▶ Take ratchet ring spanner ④ and auxiliary tool ③ for the spare wheel lifter out of the vehicle tool kit.
- ▶ Push auxiliary tool ③ through opening ① into the winch guide.
- ▶ Secure extraction device ⑦ to the wheel.
- ▶ Place the wheel on the ground with the wheel brace pointing upwards.
- ▶ Align the wheel so that the loop of extraction device ⑦ points backwards.
- ▶ Guide the wheel gripper at an angle on the wire into the wheel brace.
- ▶ Slide the wheel under the vehicle a little.
- ▶ Place ratchet ring spanner ④ onto auxiliary tool ③ for the spare wheel lifter so that the letters "AUF" are visible.

- ▶ Turn ratchet ring spanner ④ in the direction of arrow ⑤ until you feel resistance or until the friction clutch of the winch overwinds.
- ▶ Pull wheel wrench ④ and auxiliary tool ③ for the spare wheel lifter out of the opening for the winch and stow them in the vehicle tool kit.
- ▶ Close the rear-end doors.

Vehicles with rear wheel drive: removing the spare wheel (panel van/crewbus)

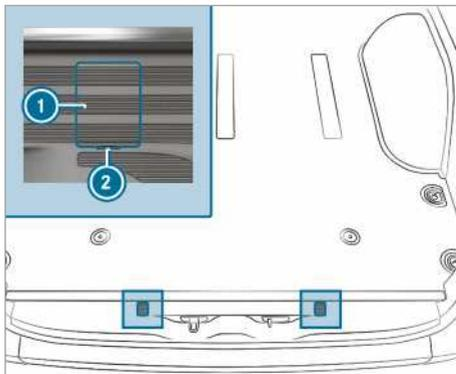

Bolt covers for the safety hooks (example: panel van)

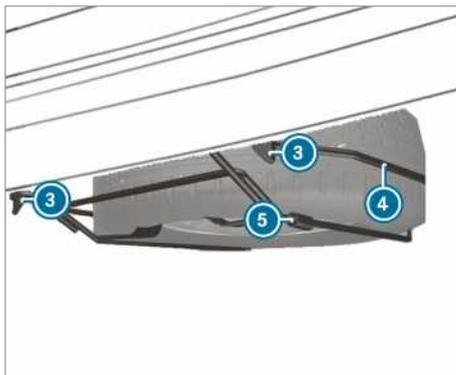

- ▶ Open the rear-end doors.
- ▶ Place a screwdriver into recesses ② and then prise off covers ①.
- ▶ Using the wheel wrench from the vehicle tool kit, unscrew the now visible bolts anti-clockwise by approximately 20 turns.
- ▶ Slightly raise spare wheel carrier ④ and unhook left-hand safety hook ③.

- ▶ Assemble the pump lever for the jack and slide it into sleeve ⑤ on the right-hand side of spare wheel carrier ④.
- ▶ Raise spare wheel carrier ④ with the pump lever and unhook right-hand safety hook ③.
- ▶ Slowly lower spare wheel carrier ④ to the ground.
- ▶ Lift spare wheel carrier ④ slightly and pull the pump lever out of the sleeve.
- ▶ Use the pump lever to lift the spare wheel beyond the rear edge of spare wheel carrier ④.
- ▶ Carefully remove the spare wheel from spare wheel carrier ④. The spare wheel is heavy. When the spare wheel is removed, the centre of gravity changes due to the heavy weight of the wheel. The spare wheel may slip down or tip over.

Vehicles with rear wheel drive: fitting the spare wheel (panel van/crewbus)

- ▶ Carefully place the spare wheel onto spare wheel carrier ④. The spare wheel is heavy. When you place the spare wheel onto spare wheel carrier ④, the centre of gravity changes due to the weight of the wheel. The spare wheel may slip down or tip over.
- ▶ Slide the pump lever for the jack into sleeve ⑤ on spare wheel carrier ④.
- ▶ Raise spare wheel carrier ④ with the pump lever and attach right-hand safety hook ③.
- ▶ Slightly raise spare wheel carrier ④ and attach left-hand safety hook ③.
- ▶ Pull the pump lever out of sleeve ⑤.
- ▶ Using the wheel wrench, tighten safety hook bolts ③ by turning them clockwise.
- ▶ Replace and engage covers ①.
- ▶ Close the rear-end doors.

Vehicles with rear wheel drive: removing the spare wheel (vehicle with lowered chassis)

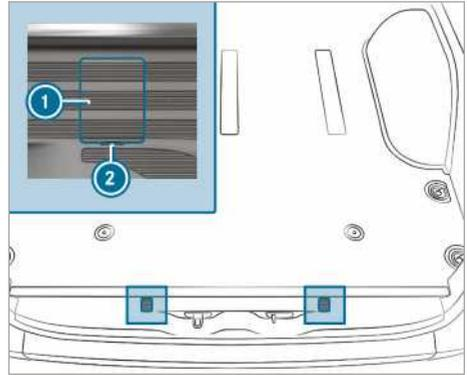

Bolt covers for the safety hooks (example: panel van)

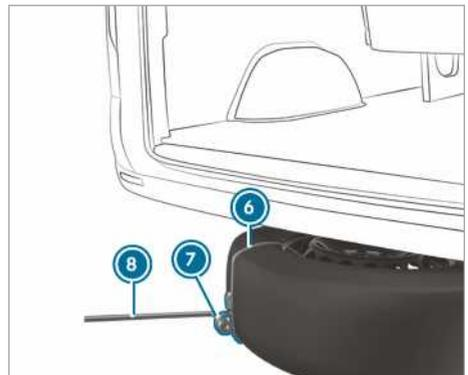
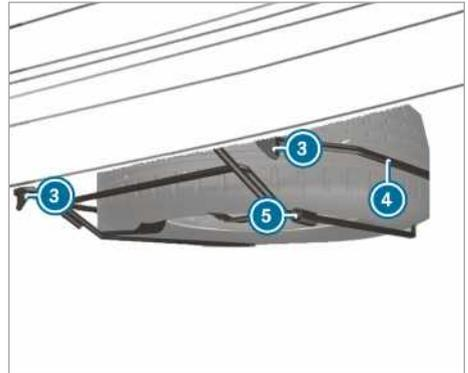

- ▶ Open the rear-end doors.

- ▶ Place a screwdriver into recesses ② and then prise off covers ①.
- ▶ Using the wheel wrench from the vehicle tool kit, unscrew the now visible bolts anti-clockwise by approximately 20 turns.
- ▶ Slightly raise spare wheel carrier ④ and unhook left-hand safety hook ③.
- ▶ Assemble the pump lever for the jack and slide it into sleeve ⑤ on the right-hand side of spare wheel carrier ④.
- ▶ Raise the spare wheel carrier with the pump lever and unhook right-hand safety hook ③.
- ▶ Position loop ⑦ of extraction device ⑥ on the spare wheel so that you will later be able to attach wheel wrench ⑧.
- ▶ Prepare the jack.
- ▶ Place the jack beneath the corresponding jack support point.
- ▶ Move the pump lever up and down until the tyre is raised a maximum of 3 cm off the ground.
- ▶ Hook wheel wrench ⑧ into loop ⑦ of extraction device ⑥ on the spare wheel.
- ▶ Carefully remove the spare wheel from spare wheel carrier ④. The spare wheel is heavy. When the spare wheel is removed, the centre of gravity changes due to the heavy weight of the wheel. The spare wheel may slip down or tip over.
- ▶ Remove the spare wheel extraction device and store it in a safe place. You can now fit the spare wheel to your vehicle.
- ▶ Lower the vehicle.

Vehicles with rear wheel drive: fitting the spare wheel (vehicle with lowered chassis)

- ① In the event of a flat tyre, you may store the defective wheel inside the vehicle only. An intact wheel may be stored in the spare wheel carrier only when the vehicle is unladen. A laden vehicle must first be raised.
- ▶ Carefully place the spare wheel onto spare wheel carrier ④. The spare wheel is heavy. When you place the spare wheel onto spare wheel carrier ④, the centre of gravity changes due to the weight of the wheel. The spare wheel may slip down or tip over.
- ▶ Slide the pump lever for the jack into sleeve ⑤ on spare wheel carrier ④.

- ▶ Raise spare wheel carrier ④ with the pump lever and attach right-hand safety hook ③.
- ▶ Slightly raise spare wheel carrier ④ and attach left-hand safety hook ③.
- ▶ Pull the pump lever out of sleeve ⑤.
- ▶ Using the wheel wrench, tighten safety hook bolts ⑤ by turning them clockwise.
- ▶ Replace and engage covers ①.
- ▶ Close the rear-end doors.

Removing the spare wheel in the load compartment

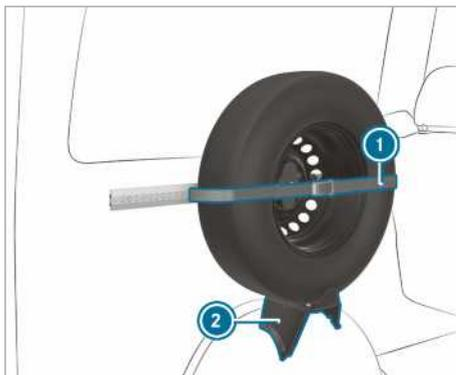

- ▶ Release clamping strap ① by opening the ratchet.
- ▶ Carefully remove the spare wheel from bracket ②.

Fitting the spare wheel in the load compartment

- ▶ Place the spare wheel in bracket ② and press it onto the wall.
- ▶ Tighten clamping strap ① with the ratchet.

Vehicles with rear wheel drive: removing the spare wheel (chassis)

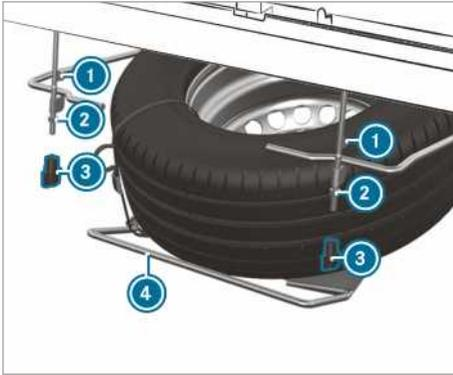

- ▶ Raise spare wheel carrier (4) with the pump lever and attach right-hand safety hook (1).
- ▶ Slightly raise the spare wheel carrier and attach left-hand safety hook (1).
- ▶ Pull the pump lever out of the sleeve.
- ▶ Tighten nuts (2).
- ▶ Put wing nuts (3) in place and tighten them.

- ▶ Loosen wing nuts (3) manually and then remove them.
- ▶ Loosen nuts (2) as far as the thread end.
- ▶ Slightly raise spare wheel carrier (4) and unhook left-hand safety hook (1).
- ▶ Assemble the pump lever for the jack and slide it into the sleeve on the right-hand side of spare wheel carrier (4).
- ▶ Raise spare wheel carrier (4) with the pump lever and unhook right-hand safety hook (1).
- ▶ Slowly lower spare wheel carrier (4) to the ground.
- ▶ Lift spare wheel carrier (4) slightly and pull the pump lever out of the sleeve.
- ▶ Use the pump lever to lift the spare wheel beyond the rear edge of the spare wheel carrier.
- ▶ Carefully remove the spare wheel from the spare wheel carrier. The spare wheel is heavy. When the spare wheel is removed, the centre of gravity changes due to the heavy weight of the wheel. The spare wheel may slip down or tip over.

Vehicles with rear wheel drive: fitting the spare wheel (chassis)

- ▶ Carefully place the spare wheel onto spare wheel carrier (4). The spare wheel is heavy. When you place the spare wheel onto the spare wheel carrier, the centre of gravity changes due to the weight of the wheel. The spare wheel may slip down or tip over.
- ▶ Slide the pump lever for the jack into the sleeve on spare wheel carrier (4).

Information on technical data

The technical data was determined in accordance with EU Directives. The given data only applies to vehicles with standard equipment. Further information can be obtained at a qualified specialist workshop.

Only for certain countries: you can find vehicle-specific vehicle data in the COC documents (CERTIFICATE OF CONFORMITY). These documents are supplied when the vehicle is delivered.

On-board electronics

Notes on work on the engine electronics

! **NOTE** Premature wear through improper maintenance

Improper maintenance may cause vehicle components to wear more quickly and the vehicle's operating permit may be invalidated.

- ▶ Always have work on the engine electronics and related components carried out at a qualified specialist workshop.

Two-way radios

Installation notes for two-way radios

! **WARNING** Risk of accident due to improper work on two-way radios

The electromagnetic radiation from two-way radios can interfere with the on-board electronics if RF transmitters are manipulated or retrofitted incorrectly.

This could jeopardise the operating safety of the vehicle.

- ▶ You should have all work on electrical and electronic components carried out at a qualified specialist workshop.

! **WARNING** Risk of accident from incorrect operation of two-way radios

If you operate two-way radios incorrectly in the vehicle, the electromagnetic radiation could interfere with the on-board electronics, e.g.:

- if the two-way radio is not connected to an exterior aerial
- if the exterior aerial is not correctly mounted or is not of low reflection

This could jeopardise the operating safety of the vehicle.

- ▶ Have the low-reflection exterior aerial fitted at a qualified specialist workshop.
- ▶ When operating two-way radios in the vehicle, always connect them to the low-reflection exterior aerial.

! **NOTE** Invalidation of the operating permit due to failure to comply with the instructions for installation and use

The operating permit may be invalidated if the instructions for installation and use of two-way radios are not observed.

- ▶ Only use approved frequency bands.
- ▶ Observe the maximum permissible output power in these frequency bands.
- ▶ Only use approved aerial positions.

Use Technical Specification ISO/TS 21609 (Road Vehicles - EMC guidelines for installation of after-market radio frequency transmitting equipment) when retrofitting two-way radios. Comply with the legal requirements for detachable parts.

If your vehicle has fittings for two-way radio equipment, use the power supply or aerial connections intended for use with the fittings. Observe the manufacturer's supplement during installation.

Information on two-way radio transmission output

The maximum transmission outputs (PEAK) at the base of the aerial must not exceed the values in the following table:

Frequency band and maximum transmission output

Frequency band	Maximum transmission output
Short wave 3 – 54 MHz	100 W
4 – m – waveband 74 – 88 MHz	30 W
2 – m – waveband 144 – 174 MHz	50 W

Frequency band	Maximum transmission output
Trunked radio system/Tetra 380 – 460 MHz	10 W
70 – cm – waveband 420 – 450 MHz	35 W
Two-way radio (2G/3G/4G)	10 W

The following can be used in the vehicle without restrictions:

- two-way radios with a maximum transmission output of up to 100 mW
- two-way radios with transmitter frequencies in the 380 – 410 MHz frequency band and a maximum transmission output of up to 2 W (trunked radio system/Tetra)
- mobile phones (2G/3G/4G)

There are no restrictions when positioning the aerial on the outside of the vehicle for the following frequency bands:

- Trunked radio system/Tetra
- 70 – cm – waveband
- 2G/3G/4G

Vehicle identification plate, vehicle identification number (VIN) and engine number

Vehicle identification plate

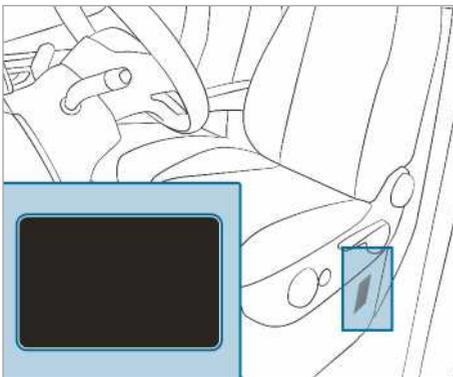

Depending on the vehicle model, the vehicle identification plate is located on the seat base of the driver's seat or on the B-pillar.

The data is vehicle-specific and can differ from that shown. Always observe the specifications on your vehicle's identification plate.



Vehicle identification plate (example: Gulf States)

- ① Vehicle manufacturer
- ② VIN (vehicle identification number)
- ③ Permissible gross mass
- ④ Permissible front axle load (kg)
- ⑤ Permissible rear axle load (kg)
- ⑥ Engine type
- ⑦ Date of manufacture

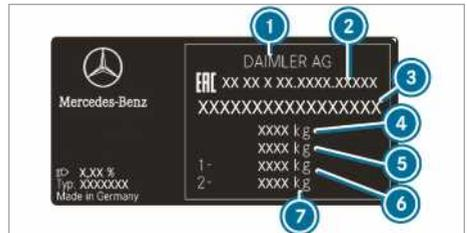

Vehicle identification plate (example: Russia)

- ① Vehicle manufacturer
- ② Type approval number
- ③ VIN (vehicle identification number)
- ④ Permissible gross mass (kg)
- ⑤ Permissible gross mass of vehicle combination (kg) (for specific countries only)
- ⑥ Permissible front axle load (kg)
- ⑦ Permissible rear axle load (kg)

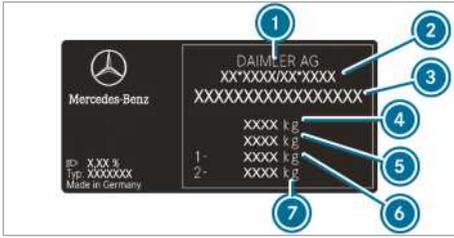

Vehicle identification plate (example: all other countries)

- ① Vehicle manufacturer
- ② EU general operating permit number (only for certain countries)
- ③ VIN (vehicle identification number)
- ④ Permissible gross mass (kg)
- ⑤ Permissible gross mass of vehicle combination (kg) (for specific countries only)
- ⑥ Permissible front axle load (kg)
- ⑦ Permissible rear axle load (kg)

Vehicle identification plate may also contain the following data:

- payload
- kerb weight
- number of passenger seats

VIN engraved underneath the bonnet

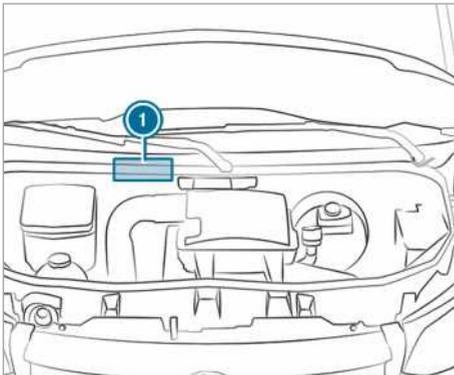

Engraved VIN ① is located underneath the bonnet.

VIN underneath the windscreen

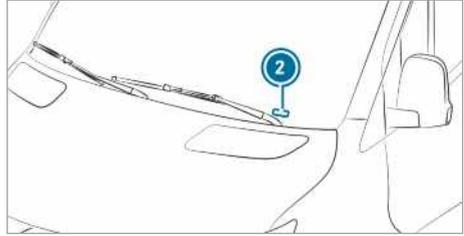

The VIN is also attached as a label on the lower section of windscreen ②.

The VIN underneath the windscreen is only available for certain countries.

Engine number

The engine number is stamped onto the crankcase. You can obtain further information from any qualified specialist workshop.

Operating fluids and capacities

Notes on operating fluids

⚠ WARNING Risk of injury from operating fluids harmful to your health

Operating fluids may be poisonous and harmful to your health.

- ▶ Observe the text on the original containers when using, storing or disposing of operating fluids.
- ▶ Always store operating fluids sealed in their original containers.
- ▶ Always keep children away from operating fluids.

🌿 ENVIRONMENTAL NOTE Environmental pollution due to disposing of operating fluids in a non-environmentally responsible manner

Operating fluids include the following:

- fuels
- exhaust gas aftertreatment additives, e.g. AdBlue®
- lubricants

Incorrect disposal of operating fluids can cause considerable damage to the environment.

- ▶ Dispose of operating fluids in an environmentally responsible manner.

Operating fluids include the following:

- fuels
- exhaust gas aftertreatment additives, e.g. AdBlue®
- lubricants
- coolant
- brake fluid
- windscreen washer fluid
- climate control system refrigerants

Use only products recommended by Mercedes-Benz. Damage caused by the use of products that have not been approved is not covered by the Mercedes-Benz guarantee or goodwill gestures.

You can identify operating fluids approved by Mercedes-Benz by the following inscriptions on the container:

- MB-Freigabe (e.g. MB-Freigabe 229.51)
- MB-Approval (e.g. MB-Approval 229.51)

Further information on approved operating fluids:

- in the Mercedes-Benz Specifications for Operating Fluids at <http://bevo.mercedes-benz.com> (by entering the designation)
- at a qualified specialist workshop

⚠ WARNING Risk of fire or explosion from fuel

Fuels are highly flammable.

- ▶ Fire, naked flames, smoking and creation of sparks must be avoided.
- ▶ Switch off the ignition and, if available, the stationary heater, before and while refuelling the vehicle.

⚠ WARNING Risk of injury from fuels

Fuels are poisonous and hazardous to your health.

- ▶ Do not swallow fuel or let it come into contact with skin, eyes or clothing.
- ▶ Do not inhale fuel vapour.
- ▶ Keep children away from fuel.
- ▶ Keep doors and windows closed during the refuelling process.

If you or other people come into contact with fuel, observe the following:

- ▶ Immediately rinse fuel off your skin with soap and water.
- ▶ If fuel comes into contact with your eyes, immediately rinse them thoroughly with clean water. Seek medical attention immediately.
- ▶ If you swallow fuel, seek medical attention immediately. Do not induce vomiting.
- ▶ Change immediately out of clothing that has come into contact with fuel.

Fuel

Notes on fuel grades on vehicles with diesel engines

General notes

Observe the notes on operating fluids (→ page 349).

⚠ WARNING Risk of fire from fuel mixture

If you mix diesel fuel with petrol, the flash point of the fuel mixture is lower than that of pure diesel fuel.

While the engine is running, component parts in the exhaust system may overheat without warning.

- ▶ Never refuel using petrol in diesel engines.
- ▶ Never mix petrol with diesel fuel.

! NOTE Damage due to incorrect fuel

Even small amounts of the wrong fuel could result in damage to the fuel system, the engine and emission control system.

- ▶ Only refuel using sulphur-free diesel fuel that conforms to the European standard EN 590 or an equivalent specification. In countries without sulphur-free diesel fuel, only fill up with low-sulphur diesel fuel with a sulphur content of less than 50 ppm.

Never refuel with:

- petrol
- marine diesel

- heating oil
- pure bio-diesel or vegetable oil
- paraffin or kerosene

If you have accidentally refuelled with the wrong fuel:

- ▶ do not switch on the ignition.
- ▶ Consult a qualified specialist workshop.

The following compatibility mark for fuel applies to your vehicle:



- ① For diesel fuel with a maximum of 7% by volume bio-diesel (fatty acid methyl ester)

In accordance with the European standard EN 16942, you will find the compatibility marks for fuel in the following places:

- on the vehicle on the instruction label in the fuel filler flap
- throughout Europe on the fuel pumps or pump nozzles suitable for your vehicle

XTL-compatible vehicles

Alternatively, you can also refuel with paraffinic diesel fuel (e.g. HVO=hydrogenated vegetable oil, GTL=Gas-To-Liquid) that complies with the European standard EN 15940. Paraffinic diesel fuels are collectively known as XTL.

In accordance with European standard EN 16942, the following fuel compatibility marks apply to your XTL-compatible vehicle:



- ① For diesel fuel with a maximum of 7% by volume bio-diesel (fatty acid methyl ester)

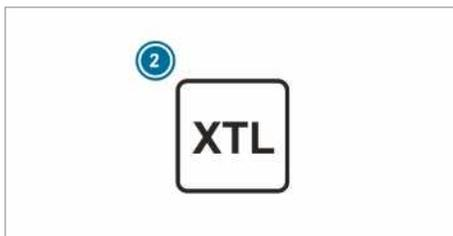

- ② For paraffinic diesel fuel

- ⓘ **Refuel with paraffinic diesel fuels to EN 15940 only if the appropriate compatibility mark is present in your fuel filler flap.**

Notes on low outside temperatures

Refuel your vehicle with as much winter diesel fuel as possible at the beginning of winter.

Before switching to winter diesel fuel, the fuel tank should be as empty as possible. When first refuelling with winter diesel fuel, only refuel using a small amount, e.g. to reserve level. When refuelling the next time, the fuel tank can be filled normally again.

Further information on fuel is available:

- at a filling station
- at a qualified specialist workshop

Tank content and fuel reserve

The total capacity of the fuel tank may vary, depending on the vehicle equipment.

Tank content and fuel reserve

Diesel engine	Total capacity
OM651	approx. 50 litres
OM651	approx. 65 litres
OM651/OM642	approx. 71 litres

Diesel engine	Total capacity
OM651	approx. 92 litres
OM651/OM642	approx. 93 litres
Diesel engine	Of which reserve fuel
Models with approx. 50 l total capacity	approx. 12 litres
Models with approx. 65 l total capacity	approx. 12 litres
Models with approx. 71 l total capacity	approx. 12 litres
Models with approx. 92 l total capacity	approx. 12 litres
Models with approx. 93 l total capacity	approx. 12 litres

AdBlue®

Notes on AdBlue®

Observe the notes on operating fluids (→ page 349).

AdBlue® is a water-soluble fluid for the exhaust gas aftertreatment of diesel engines.

! **NOTE** Damage caused by additives in AdBlue® or by diluting AdBlue®

The AdBlue® exhaust gas aftertreatment system could be destroyed by the following:

- additives in AdBlue®
 - diluting AdBlue®
- ▶ Only use AdBlue® in accordance with ISO 22241.
- ▶ Do not mix additives.
- ▶ Do not dilute AdBlue®.

! **NOTE** Damage and malfunctions caused by impurities in AdBlue®

Impurities in AdBlue® result in the following:

- higher emission values
- damage to the catalytic converter
- engine damage

- malfunctions in the AdBlue® exhaust gas aftertreatment system

▶ Avoid impurities in AdBlue®.

ENVIRONMENTAL NOTE Staining due to AdBlue®

AdBlue® residue crystallises after some time and stain the affected surfaces.

▶ Immediately rinse surfaces that come in contact with AdBlue® when filling with water or remove AdBlue® with a damp cloth and cold water.

If AdBlue® has already crystallised, clean using a sponge and cold water.

If you open the AdBlue® tank, small amounts of ammonia vapour may be released. Do not inhale any ammonia vapours that may be released. Fill the AdBlue® tank only in well-ventilated areas.

AdBlue® consumption and filling capacity

AdBlue® consumption

Like fuel consumption, AdBlue® consumption is highly dependent upon driving style and operating conditions. AdBlue® consumption is usually within a range of 0 and 10% of the fuel consumption. If necessary, AdBlue® must be refilled in accordance with the instructions when the refill message is displayed in the instrument cluster. This may also be necessary between the scheduled maintenance.

Check the AdBlue® fill level before making journeys outside of Europe. You can refill AdBlue® at the AdBlue® filling pumps at a filling station or using commercially available refill containers.

Total capacity of AdBlue® tank

Vehicle	Total capacity
All models	22 litres

Exhaust gas aftertreatment

The exhaust gas aftertreatment system must be operated in conjunction with AdBlue® if it is to function correctly.

If you operate the vehicle without AdBlue® or with emissions-relevant malfunctions, the MOT approval is invalidated. The legal consequence of this is that the vehicle may no longer be operated on public roads.

It may be improper or punishable in some countries to operate a vehicle that uses no AdBlue® or one that does not comply with the specifications of these operating instructions.

Engine management monitors the exhaust gas aftertreatment components for compliance with emissions laws and regulations. If you attempt to operate the vehicle without AdBlue®, with diluted AdBlue® or with a different reducing agent, this will be detected by the engine management system. Other emissions-relevant malfunctions, e.g. metering malfunctions or sensor errors, are also detected and logged.

The engine management system subsequently prevents the engine being restarted after issuing a warning message.

Therefore top up the AdBlue® tank regularly during vehicle operation or, at the latest, after receiving the first warning message via the instrument cluster.

Engine oil

Notes on engine oil

Observe the notes on operating fluids (→ page 349).



! **NOTE** Engine damage caused by an incorrect oil filter, incorrect oil or additives

- ▶ Do not use engine oils or oil filters which do not correspond to the specifications explicitly prescribed for the service intervals.
- ▶ Do not alter the engine oil or oil filter in order to achieve longer change intervals than prescribed.
- ▶ Do not use additives.
- ▶ Have the engine oil renewed at regular intervals.

Mercedes-Benz recommends having the oil changed at a qualified specialist workshop.

Only Mercedes-Benz-approved engine oils may be used in Mercedes-Benz engines.

Further information on engine oil and oil filter:

- in the Mercedes-Benz Specifications for operating fluids at <http://bevo.mercedes-benz.com> (by entering the designation)
- at a qualified specialist workshop

Quality and capacity of engine oil

i The containers of the various engine oils are marked with the ACEA (Association of European Automotive Manufacturers) and/or API (America Petroleum Institute) classifications. Only use approved engine oils that correspond to the MB Specifications for operating fluids and the prescribed ACEA and/or API classifications named below. Engine oils of other grades are not permissible and can result in the loss of the New Vehicle Limited Warranty. The use of other engine oils not approved for diesel engines can damage the diesel particulate filter (DPF).

MB-Freigabe or MB-Approval

Diesel engines	MB-Freigabe or MB-Approval
OM642/OM651	228.51, 229.31, 229.51, 229.52

If the engine oils listed in the table are not available, you may add a maximum 1.0 litre of the following engine oils once only:

- MB-Freigabe or MB-Approval 228.5, 229.3 or 229.5

Multigrade engine oils of the prescribed SAE classification (viscosity) may be used all year round, taking the outside temperature into account.

Viscosity of the engine oil

! **NOTE** Engine damage due to incorrect SAE classification (viscosity) of the engine oil

If the SAE classification (viscosity) of the engine oil added is not suitable for prolonged low outside temperatures, it may cause engine damage.

The temperature readings of the SAE classification are always based on fresh oil. Engine

oil ages when driving as a result of soot and fuel residue. The characteristics of engine oil deteriorate significantly at low outside temperatures.

- ▶ Use an engine oil of the appropriate SAE classification at low outside temperatures.
- ▶ Use oil for all-year-round operation.

The temperature readings of the SAE classification are always based on fresh oil. The temperature characteristics of the engine oil, especially at low outside temperatures, can deteriorate significantly due to ageing when driving.

Therefore, Mercedes-Benz recommends that you change the engine oil before the start of the cold season. Only use an approved engine oil in the prescribed SAE classification for this purpose.

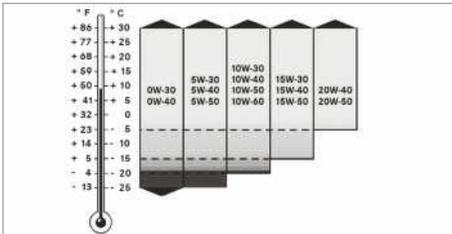

The viscosity indicates the flow characteristics of a fluid. With regard to engine oil, a high viscosity is synonymous with thick liquid and a low viscosity with thin liquid. Depending on the outside temperatures, select the engine oil according to the SAE classification (viscosity). The table shows the SAE classifications to be used. The low temperature characteristics of engine oils can deteriorate significantly during operation due to ageing and soot and fuel accretion, for example. A regular oil change with an approved engine oil in the appropriate SAE classification is therefore strongly recommended.

Additive

! **NOTE** Engine damage due to use of additives in the engine oil

The use of additional additives in the engine oil can damage the engine.

- ▶ Do not use any additional additives in the engine oil.

Miscibility of engine oil

The benefits of high-quality engine oils are reduced by mixing oil.

We recommend that you only use engine oil of the same grade and SAE classification as the oil filled at the last oil change. If, in exceptional cases, oil of the type in the engine is not available, use another approved mineral or synthetic engine oil.

You must then have an oil change carried out at the earliest possible opportunity.

Engine oils are distinguished by:

- engine oil brand
- grade (MB-Freigabe or MB-Approval)
- SAE classification (viscosity)

Oil change interval

The on-board computer automatically shows the date of the next oil change as an event message on the display.

Mercedes-Benz recommends having the oil changed at a qualified specialist workshop.

Engine oil capacities

Engine	Engine oil
OM642	approx. 12.5 litres
OM651 (rear wheel drive)	approx. 11.5 litres
OM651 (front wheel drive)	approx. 8 litres



- ① Oil drain screw access (vehicles with under-floor panelling)

Information on oil consumption

Depending on the driving style, the vehicle consumes a maximum of 1.0 litre of engine oil per 1000 km.

In the following cases, oil consumption may also exceed this limit:

- the vehicle is new.

- you use the vehicle mostly under arduous conditions.
- you drive frequently at a high engine speed.

Regular maintenance is a prerequisite for favourable consumption figures. You can only assess the oil consumption after a long journey. Check the oil level in the engine regularly, e.g. weekly or every time you refuel.

Notes on brake fluid

Observe the notes on operating fluids (→ page 349).

⚠ WARNING Risk of an accident due to vapour pockets forming in the brake system

The brake fluid constantly absorbs moisture from the air. This lowers the boiling point of the brake fluid. If the boiling point is too low, vapour pockets may form in the brake system when the brakes are applied hard.

This impairs the braking effect.

- ▶ Have the brake fluid renewed at the specified intervals.

! NOTE Damage to paint, plastic or rubber by brake fluid

There is a risk of damage to property if brake fluid comes into contact with paint, plastic or rubber.

- ▶ If paint, plastic or rubber comes into contact with brake fluid, rinse with water immediately.

Observe the notes on paintwork/matt finish paintwork care (→ page 287).

Have the brake fluid replaced regularly at a qualified specialist workshop.

Only use brake fluid approved by Mercedes-Benz in accordance with MB-Freigabe or MB-Approval 331.0.

Further information on brake fluid:

- in the Mercedes-Benz Specification for Service Products at <http://bevo.mercedes-benz.com>
- at a qualified specialist workshop

Coolant

Notes on coolant

Observe the notes on operating fluids (→ page 349).

⚠ WARNING Risk of fire- and injury from antifreeze

If antifreeze comes into contact with hot component parts in the engine compartment, it may ignite.

- ▶ Allow the engine to cool down before you top up the antifreeze.
- ▶ Make sure that no antifreeze spills out next to the filler opening.
- ▶ Thoroughly clean the antifreeze from component parts before starting the vehicle.

! NOTE Damage caused by incorrect coolant

- ▶ Only add coolant that has been pre-mixed with the required antifreeze protection.

Information on coolant is available at the following locations:

- in the Mercedes-Benz Specification for operating fluids 310.1
 - at <http://bevo.mercedes-benz.com>
 - in the Mercedes-Benz BeVo app
- at a qualified specialist workshop

! NOTE Overheating at high outside temperatures

If an inappropriate coolant is used, the engine cooling system is not sufficiently protected against overheating and corrosion at high outside temperatures.

- ▶ Always use a coolant approved by Mercedes-Benz.
- ▶ Observe the instructions in the Mercedes-Benz Specifications for operating fluids 310.1.

! NOTE Paintwork damage due to coolant

- ▶ Do not spill coolant on painted surfaces.

Have the coolant regularly replaced at a qualified specialist workshop.

Note the proportion of anti-corrosion agent/anti-freeze in the engine cooling system within the following temperature ranges:

- at least 50% (antifreeze protection up to about -37 °C)
- maximum 55% (antifreeze protection up to -45 °C)

Windscreen washer fluid

Notes on windscreen washer fluid

Observe the notes on operating fluids (→ page 349).

⚠ WARNING - Risk of fire and injury due to windscreen washer concentrate

Windscreen washer concentrate is highly flammable. It could ignite if it comes into contact with hot engine component parts or the exhaust system.

- ▶ Make sure that no windscreen washer concentrate spills out next to the filler opening.

! NOTE Damage to the exterior lighting due to unsuitable windscreen washer fluid

Unsuitable windscreen washer fluids may damage the plastic surface of the exterior lighting.

- ▶ Only use windscreen washer fluids which are also suitable for use on plastic surfaces, e.g. MB SummerFit or MB WinterFit.

! NOTE Blocked spray nozzles caused by mixing windscreen washer fluids

- ▶ Do not mix MB SummerFit and MB WinterFit with other windscreen washer fluids.

Do not use distilled or de-ionised water. Otherwise, the level sensor may give a false reading.

Information on the windscreen washer fluid

Recommended windscreen washer fluid:

- above freezing point: e.g. MB SummerFit
- below freezing point: e.g. MB WinterFit

Mixing ratio

For the correct mixing ratio, refer to the information on the anti-freeze container.

Mix the washer fluid with windscreen washer fluid all year round.

Refrigerant

Notes on refrigerant

Observe the notes on operating fluids (→ page 349).

- ① Your vehicle's climate control system can be filled with R-134a refrigerant. The refrigerant R-134a contains fluorinated greenhouse gas.

If your vehicle is filled with R-134a refrigerant, the following information applies:

! NOTE Damage caused by incorrect refrigerant

If the incorrect refrigerant is used, this can damage the climate control system.

- ▶ Use only R-134a refrigerant or the PAG oil approved for your vehicle by Mercedes-Benz.
- ▶ The approved PAG oil may not be mixed with any other PAG oil that is not approved for R-134a refrigerant.

Maintenance work, such as topping up the refrigerant or replacing components, may be carried out only by a qualified specialist workshop. All the applicable regulations relating to this and the SAE J639 standard must be adhered to.

All work on the climate control system should always be carried out at a qualified specialist workshop.

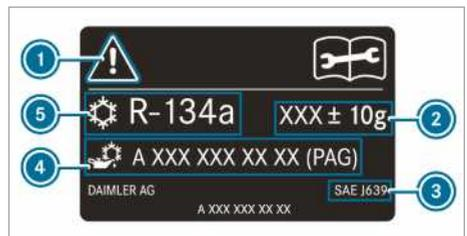

Example: refrigerant warning label

- ① Warning symbols
- ② Refrigerant capacity
- ③ Applicable standards

- ④ PAG oil part number
- ⑤ Refrigerant type

The warning symbols ① refer to the following:

- potential dangers
- the performance of maintenance work at a qualified specialist workshop

Vehicle data

Information on vehicle dimensions

The following section contains important technical data for your vehicle. Your vehicle documents contain further vehicle-specific and equipment-dependent technical data such as vehicle dimensions and weights.

Current technical data can also be found online at <http://www.mercedes-benz.com>.

Trailer hitch

Notes on the trailer hitch

⚠ WARNING Risk of accident due to impermissible retrofitting of a trailer tow hitch

If a trailer tow hitch has been retrofitted impermissibly and you fit a trailer tow hitch or other assembly parts, the longitudinal frame member will be weakened and may break. In this case, the trailer may come loose from the vehicle.

There is a risk of an accident.

Only retrofit a trailer tow hitch if it is permissible.

Observe the notes on trailer operation (→ page 175).

Retrofitting a trailer hitch is only permissible if a towing capacity is specified in your vehicle documents.

You can obtain further information on the trailer hitch at a qualified specialist workshop or on the Internet at https://bb-portal.mercedes-benz.com/portal/kat_iv.html?&L.

Mercedes-Benz recommends that you have a trailer hitch retrofitted at a Mercedes-Benz Service Centre.

Only use a trailer hitch which has been tested and specially approved by Mercedes-Benz for your vehicle.

The maximum permissible towing capacity for trailers without a separate braking system is 750 kg.

Trailer loads

When towing a trailer, the maximum permissible gross vehicle weight is increased by 100 kg for vehicles with passenger vehicle approval. The maximum permissible rear axle load must be observed. The road speed of the vehicle must be limited to a maximum of 100 km/h, in accordance with Directive 92/21/EEC.

The permissible weights and loads which must not be exceeded can also be obtained from the following sources of information:

- Vehicle documents
- The identification plates of the trailer hitch, trailer and vehicle

If the values differ, the lowest value applies.

Maximum tongue weight

The tongue weight must not exceed:

- 100 kg with a trailer load of 2000 kg
- 120 kg with a trailer load of 2800 kg or 3000 kg
- 140 kg with a trailer load of 3500 kg

Lashing points and carrier systems

Information about the lashing points

! **NOTE** Risk of accident if the maximum loading capacity of the lashing points is exceeded

If you combine various lashing points to secure a load, always take the maximum loading capacity of the weakest lashing point into account.

During maximum full-stop braking, forces may act which can multiply the weight of the load.

▶ Always use several lashing points to distribute and spread the load. Distribute the load on the lashing points evenly.

Further information on the lashing points and tie-down eyes can be obtained in the "Transporting" section (→ page 271).

Tie-down eyes

Max. tensile load (tie-down eyes)

Tie-down eyes	Permissible nominal tensile strength
Crewbus	350 daN
Panel van	800 daN
Platform vehicles with up to 3.5 t maximum gross weight	400 daN
Platform vehicles with more than 3.5 t maximum gross weight	800 daN

Loading rails

Max. tensile load of lashing points in load compartment

Lashing point	Permissible nominal tensile strength
Loading rails on load compartment floor	500 daN
Lower loading rail on side wall	200 daN
Upper loading rail on side wall	125 daN

The values specified apply only to loads resting on the load compartment floor if you observe the following:

- the load is secured to two lashing points on the rail
- the distance to the nearest load-securing point on the same rail is approximately 1 m

Information about roof racks

⚠ WARNING Risk of injury due to the maximum roof load being exceeded

When you place a load on the roof as well as all outer and inner attachments, the vehicle's centre of gravity will rise and the familiar driving characteristics as well as the steering and braking characteristics will change. When driving around bends, the vehicle will tilt more heavily and may react more sluggishly to steering movements.

If you exceed the maximum roof load, the driving characteristics, as well as the steering and braking, will be greatly impaired.

- ▶ Never exceed the maximum roof load and adjust your driving style.

⚠ WARNING Danger of accident due to uneven loading

If you load the vehicle unevenly, the handling characteristics as well as the steering- and braking characteristics can be heavily impaired.

- ▶ Load the vehicle evenly.
- ▶ Secure the load against sliding.

The driving, braking and steering characteristics of the vehicle change with the type of load, the weight and the centre of gravity of the load.

! NOTE Risk of accident if the maximum permitted roof load is exceeded.

If the weight of the roof luggage, including the roof rack, exceeds the maximum permitted roof load, there is a risk of an accident.

- ▶ Ensure that the weight of the roof luggage and roof rack together does not exceed the maximum permitted roof load.
- ▶ The roof rack's supporting feet must be arranged at a uniform distance from each other.
- ▶ Mercedes-Benz recommends you install a stabiliser bar on the vehicle's front axle.

Further information about safety measures can be found in the "Transport" section (→ page 271).

Max. roof load / pairs of supporting roof rack feet

Vehicles with	Maximum roof load	Minimum number of pairs of supporting feet
Normal roof (without platform)	300 kg	6
Normal roof (with platform)	50 kg	2
High roof (without platform)	150 kg	3
Crewcab	100 kg	2

This information applies if the load is distributed evenly across the entire roof surface.

If the roof rack is shorter, reduce the load proportionately. The maximum load per pair of supporting roof rack feet is 50 kg.

The loading guidelines and other information about load distribution and load securing can be found in the "Transport" section (→ page 271).

Information about the ladder racks

⚠ WARNING Risk of accident- and injury if the load is exceeded

If you exceed the permitted load when using the rack, the rack system may disconnect from the vehicle and endanger other road users.

▶ Always comply with the permitted load when using the rack.

Maximum load of ladder rack

	Maximum load
Front ladder rack	200 kg
Rear ladder rack	100 kg

The details apply if the load is distributed evenly across the entire ladder rack surface.

The loading guidelines and other information about load distribution and load securing can be found in the "Transport" section (→ page 271).

Display messages

Introduction

Function of display messages

The display messages appear on the multifunction display.

The display messages with graphic displays can be displayed in simplified format in the operating manual and may deviate from the display on the multifunction display. The multifunction display shows high-priority display messages in red. In addition, a warning tone sounds for specific display messages.

Act in accordance with the display messages and comply with the additional instructions in this operating manual.

In addition, symbols are shown for some display messages:

 Further information

 Hiding display messages

You can use the left-hand Touch Control to select between the symbols by swiping to the left or right. Pressing  displays further information

on the multifunction display. Pressing  hides the display message.

You can hide low-priority display messages by pressing the  button or with the left-hand Touch Control. The display messages are saved in the message memory.

Rectify the cause of a display message as quickly as possible.

You cannot hide high-priority display messages. The multifunction display will show these display messages until their causes have been rectified.

Calling up saved display messages

On-board computer:

 Service  1 message

If there are no display messages, **No messages** appears on the multifunction display.

 Browse through the display messages by swiping upwards or downwards on left-hand Touch Control.

 **Exiting the message memory:** press the button .

Safety systems

Display messages	Possible causes/consequences and  Solutions
 <p>Left windowbag malfunction Consult workshop (example)</p>	<p>* The windowbag in question is malfunctioning .</p> <div style="border: 1px solid gray; padding: 5px;"> <p> WARNING Risk of injury or fatal injury due to a malfunction in the window airbag</p> <p>The window airbag might be triggered unintentionally or might not be triggered at all in the event of an accident with high deceleration.</p> <p> Have the window airbag checked and repaired immediately at a qualified specialist workshop.</p> </div> <p> Visit a qualified specialist workshop immediately.</p>
 <p>Front left malfunction Consult workshop (example)</p>	<p>* The restraint system in question is malfunctioning .</p> <div style="border: 1px solid gray; padding: 5px;"> <p> WARNING Risk of injury due to malfunctions in the restraint system</p> <p>If the restraint system is malfunctioning, restraint system components may be triggered unintentionally or may not deploy as intended during an accident. This may affect the seat belt tensioner or airbag, for example.</p> <p> Have the restraint system checked and repaired immediately at a qualified specialist workshop.</p> </div>

Display messages	Possible causes/consequences and ► Solutions
	<p>Detection of a restraint system fault:</p> <ul style="list-style-type: none"> • The restraint system warning lamp  does not light up when the ignition is switched on. • The restraint system warning lamp  lights up continuously or repeatedly during a journey. <p>► Visit a qualified specialist workshop immediately.</p>
 <p>Restraint sys. malfunction Consult workshop</p>	<p>* The restraint system is malfunctioning .</p> <div style="border: 1px solid gray; padding: 5px; margin: 5px 0;"> <p>▲ WARNING Risk of injury due to malfunctions in the restraint system</p> <p>If the restraint system is malfunctioning, restraint system components may be triggered unintentionally or may not deploy as intended during an accident. This may affect the seat belt tensioner or airbag, for example.</p> <p>► Have the restraint system checked and repaired immediately at a qualified specialist workshop.</p> </div> <p>Detection of a restraint system malfunction:</p> <ul style="list-style-type: none"> • The restraint system warning lamp  does not light up when the ignition is switched on. • The restraint system warning lamp  lights up continuously or repeatedly during a journey. <p>► Visit a qualified specialist workshop immediately.</p>
 <p>Parking brake inoperative</p>	<p>* A malfunction has occurred in the system, the parking brake is inoperative.</p> <div style="border: 1px solid gray; padding: 5px; margin: 5px 0;"> <p>▲ WARNING Risk of an accident due to a brake system malfunction</p> <p>If the brake system is malfunctioning, braking characteristics may be impaired.</p> <p>► Drive on carefully.</p> <p>► Have the brake system checked immediately at a qualified specialist workshop.</p> </div> <p>► Park the vehicle on a level surface only and secure it against rolling away.</p> <p>► Vehicles with automatic transmission: shift the transmission to position P.</p> <p>► Vehicles with manual transmission: engage first gear.</p> <p>► Have the brake system checked at a qualified specialist workshop immediately.</p>
 <p>Incline too steep See Owner's Manual</p>	<p>* The on-board electrical system voltage is low or a malfunction has occurred in the system; the holding force may not be sufficient for the incline.</p>

Display messages	Possible causes/consequences and ► Solutions
	<p>▲ WARNING Risk of accident if the electrical parking brake has insufficient holding force</p> <p>If the electrical parking brake does not have sufficient holding force on a steep incline, the vehicle may roll away.</p> <ul style="list-style-type: none"> ► Park the vehicle on a level surface only and secure it against rolling away. ► Vehicle with automatic transmissions: shift the transmission to position P. ► Vehicles with manual transmissions: shift to first gear. <p>Observe the notes on parking the vehicle (→ page 146).</p>
<div style="border: 1px solid black; padding: 5px; text-align: center; width: 40px; margin: 0 auto;">  </div> <p>Parking brake See Owner's Manual</p>	<p>* The on-board voltage is low or a malfunction has occurred in the system; the closing force may not be sufficient for the incline.</p> <p>▲ WARNING Risk of an accident due to a brake system malfunction</p> <p>If the brake system is malfunctioning, braking characteristics may be impaired.</p> <ul style="list-style-type: none"> ► Drive on carefully. ► Have the brake system checked immediately at a qualified specialist workshop. <ul style="list-style-type: none"> ► Park the vehicle on a level surface only and secure it against rolling away. ► Vehicles with automatic transmission: shift the transmission to position P. ► Vehicles with manual transmission: engage first gear. ► Have the brake system checked at a qualified specialist workshop immediately.
<p>Check brake pads See Owner's Manual</p>	<p>* The brake pads have reached their wear limit.</p> <p>▲ WARNING Risk of accident due to restricted braking power</p> <p>When the brake pads have reached their wear limit, the braking power may be restricted.</p> <ul style="list-style-type: none"> ► Drive on carefully. ► Have the brake system checked immediately at a qualified specialist workshop. <p>► Visit a qualified specialist workshop.</p>
<div style="border: 1px solid black; padding: 5px; text-align: center; width: 40px; margin: 0 auto;">  </div> <p>Check brake fluid level</p>	<p>* There is not enough brake fluid in the brake fluid reservoir.</p> <p>▲ WARNING Risk of an accident due to low brake fluid level</p> <p>If the brake fluid level is too low, the braking effect and the braking characteristics may be impaired.</p>

Display messages	Possible causes/consequences and ► Solutions
	<ul style="list-style-type: none"> ► Stop the vehicle as soon as possible, paying attention to road and traffic conditions. Do not continue driving. ► Consult a qualified specialist workshop. ► Do not top up the brake fluid. <ul style="list-style-type: none"> ► Stop in a safe location immediately. Do not continue driving! ► Consult a qualified specialist workshop. ► Do not top up the brake fluid.
Caution Brakes overheated Drive carefully	<p>* If the all-wheel drive has been switched on, the brake system can overheat during extreme off-road use.</p> <ul style="list-style-type: none"> ► Decelerate or stop and let the brake system cool down.
Active Brake Assist Functions limited See Owner's Manual	<p>* Active Brake Assist is malfunctioning.</p> <ul style="list-style-type: none"> ► Visit a qualified specialist workshop.
Active Brake Assist Functions currently limited See Owner's Manual	<p>* Active Brake Assist is temporarily unavailable. The ambient conditions are outside the system limits (→ page 155).</p> <ul style="list-style-type: none"> ► Continue driving. When the ambient conditions are within the system limits, the system will be available again. ► If the display message does not go out, stop in a safe location and re-start the engine.
Radar sensors dirty See Owner's Manual	<p>* The radar sensor system is malfunctioning. Possible causes:</p> <ul style="list-style-type: none"> • dirt on the sensors • heavy precipitation • extended country drives without other traffic, e.g. in the desert <p>Driving systems and driving safety systems may be malfunctioning or temporarily unavailable.</p> <p>When the causes have been eliminated, the driving systems and driving safety systems will be available again.</p> <p>If the display message does not disappear, proceed as follows:</p> <ul style="list-style-type: none"> ► Stop in accordance with the traffic conditions. ► Clean all sensors (→ page 287). ► Re-start the engine.
SOS NOT READY	<p>* The Mercedes-Benz emergency call system is not available. Possible causes for this include:</p> <ul style="list-style-type: none"> • the ignition is switched off • the Mercedes-Benz emergency call system is malfunctioning <ul style="list-style-type: none"> ► Switch on the ignition. If an emergency call is unavailable, a message to this effect will appear on the multifunction display of the instrument cluster. ► Visit a qualified specialist workshop.

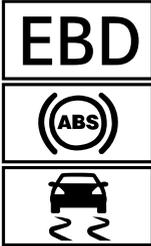
Display messages	Possible causes/consequences and ► Solutions
 <p data-bbox="110 507 334 555">inoperative See Owner's Manual</p>	<p data-bbox="407 161 1023 236">  You can find more information on the regional availability of the Mercedes-Benz emergency call system at: http://www.mercedes-benz.com/connect_ecall </p> <p data-bbox="387 252 1012 336"> * EBD, ABS and ESP® are malfunctioning. Other driving systems and driving safety systems may also be malfunctioning. </p> <div data-bbox="407 352 1028 691" style="border: 1px solid gray; padding: 5px;"> <p data-bbox="426 363 997 416">  WARNING Risk of skidding if EBD, ABS and ESP® are malfunctioning </p> <p data-bbox="421 432 990 592"> If EBD, ABS and ESP® are malfunctioning, the wheels can lock when braking and ESP® cannot carry out vehicle stabilisation. The steering capability and braking characteristics are thus severely impaired. The braking distance may increase in an emergency braking situation. In addition, other driving safety systems are switched off. </p> <ul data-bbox="421 600 990 683" style="list-style-type: none"> <li data-bbox="421 600 620 627">► Drive on carefully. <li data-bbox="421 635 990 683">► Have the brake system checked immediately at a qualified specialist workshop. </div> <p data-bbox="407 707 885 767" style="margin-top: 10px;">  Drive on carefully.  Visit a qualified specialist workshop immediately. </p>
 <p data-bbox="110 871 334 919">inoperative See Owner's Manual</p>	<p data-bbox="387 783 1012 868"> * ESP® is malfunctioning. Other driving systems and driving safety systems may also be malfunctioning. </p> <p data-bbox="407 876 990 927"> The brake system continues working with the normal effect. The braking distance can increase in emergency braking situations. </p> <div data-bbox="407 943 1028 1121" style="border: 1px solid gray; padding: 5px;"> <p data-bbox="426 954 945 981">  WARNING Risk of skidding if ESP® is malfunctioning </p> <p data-bbox="421 997 1012 1045"> If ESP® is malfunctioning, ESP® cannot carry out vehicle stabilisation. In addition, other driving safety systems are switched off. </p> <ul data-bbox="421 1053 953 1114" style="list-style-type: none"> <li data-bbox="421 1053 620 1080">► Drive on carefully. <li data-bbox="421 1088 953 1114">► Have ESP® checked at a qualified specialist workshop. </div> <p data-bbox="407 1137 885 1198" style="margin-top: 10px;">  Continue driving carefully.  Visit a qualified specialist workshop immediately. </p>
 <p data-bbox="110 1299 301 1347">currently unavailable See Owner's Manual</p>	<p data-bbox="387 1211 698 1238"> * ESP® is temporarily unavailable. </p> <p data-bbox="407 1246 1012 1297"> Other driving systems and driving safety systems may also be malfunctioning. </p> <div data-bbox="407 1313 1028 1492" style="border: 1px solid gray; padding: 5px;"> <p data-bbox="426 1324 945 1351">  WARNING Risk of skidding if ESP® is malfunctioning </p> <p data-bbox="421 1367 1012 1415"> If ESP® is malfunctioning, ESP® cannot carry out vehicle stabilisation. In addition, other driving safety systems are switched off. </p> <ul data-bbox="421 1423 953 1484" style="list-style-type: none"> <li data-bbox="421 1423 620 1450">► Drive on carefully. <li data-bbox="421 1458 953 1484">► Have ESP® checked at a qualified specialist workshop. </div>

Display messages	Possible causes/consequences and ► Solutions
<div data-bbox="96 285 247 448"> </div> <p data-bbox="88 456 277 502">currently unavailable See Owner's Manual</p>	<ul style="list-style-type: none"> ► Carefully drive some gentle curves at above 30 km/h on a suitable stretch of road. ► If the display message does not go out, visit a qualified specialist workshop immediately. Drive carefully when doing so. <p data-bbox="364 284 770 306">* ABS and ESP® are temporarily unavailable.</p> <p data-bbox="380 317 992 363">Other driving systems and driving safety systems may also be temporarily unavailable.</p> <div data-bbox="380 384 1005 724" style="border: 1px solid gray; padding: 5px;"> <p data-bbox="403 392 964 443">▲ WARNING Risk of skidding if ABS and ESP® are malfunctioning</p> <p data-bbox="398 459 988 510">If ABS and ESP® are malfunctioning, the wheels could lock when braking and ESP® cannot carry out vehicle stabilisation.</p> <p data-bbox="398 520 955 619">The steering capability and braking characteristics are thus severely impaired. The braking distance may increase in an emergency braking situation. In addition, other driving safety systems are switched off.</p> <ul style="list-style-type: none"> ► Drive on carefully. ► Have ABS and ESP® checked immediately at a qualified specialist workshop. </div> <ul style="list-style-type: none"> ► Carefully drive some gentle curves at above 30 km/h on a suitable stretch of road. ► If the display message does not go out, visit a qualified specialist workshop immediately. Drive carefully when doing so.
<div data-bbox="96 868 247 1031"> </div> <p data-bbox="88 1038 311 1085">inoperative See Owner's Manual</p>	<p data-bbox="364 866 695 888">* ABS and ESP® are malfunctioning.</p> <p data-bbox="380 900 988 946">Other driving systems and driving safety systems may also be malfunctioning.</p> <p data-bbox="380 957 967 1007">The brake system continues working with the normal effect. The braking distance can increase in emergency braking situations.</p> <div data-bbox="380 1027 1005 1367" style="border: 1px solid gray; padding: 5px;"> <p data-bbox="403 1035 964 1086">▲ WARNING Risk of skidding if ABS and ESP® are malfunctioning</p> <p data-bbox="398 1102 988 1153">If ABS and ESP® are malfunctioning, the wheels could lock when braking and ESP® cannot carry out vehicle stabilisation.</p> <p data-bbox="398 1163 955 1262">The steering capability and braking characteristics are thus severely impaired. The braking distance may increase in an emergency braking situation. In addition, other driving safety systems are switched off.</p> <ul style="list-style-type: none"> ► Drive on carefully. ► Have ABS and ESP® checked immediately at a qualified specialist workshop. </div> <ul style="list-style-type: none"> ► Continue driving carefully. ► Visit a qualified specialist workshop immediately.

Driving systems

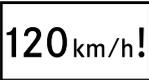
Display messages	Possible causes/consequences and ► Solutions
 <p>Maximum speed exceeded</p>	<ul style="list-style-type: none"> * You have exceeded the maximum permitted speed (only specific countries). <ul style="list-style-type: none"> ► Drive more slowly.
<p>Speed limit (winter tyres) XXX km/h</p>	<ul style="list-style-type: none"> * You have reached the maximum stored speed for winter tyres. Exceeding this speed is not possible.
 <p>km/h</p>	<ul style="list-style-type: none"> * The limiter cannot be activated as not all activation conditions have been met. <ul style="list-style-type: none"> ► Comply with the limiter's activation conditions (→ page 158).
<p>Limiter inoperative</p>	<ul style="list-style-type: none"> * The limiter is malfunctioning. <ul style="list-style-type: none"> ► Consult a qualified specialist workshop.
<p>Limiter passive</p>	<ul style="list-style-type: none"> * If you depress the accelerator pedal beyond the pressure point (kickdown), the limiter is switched to passive mode (→ page 158).
 <p>Limiter set speed exceeded</p>	<ul style="list-style-type: none"> * You have exceeded the set speed with the variable limiter by over 3 km/h.
<p>Cruise control and Limiter inoperative</p>	<ul style="list-style-type: none"> * Cruise control and the limiter are malfunctioning. <ul style="list-style-type: none"> ► Consult a qualified specialist workshop.
<p>Cruise control inoperative</p>	<ul style="list-style-type: none"> * The CRUISE CONTROL is malfunctioning. <ul style="list-style-type: none"> ► Visit a qualified specialist workshop.
 <p>Off</p>	<ul style="list-style-type: none"> * The CRUISE CONTROL has been deactivated. If a warning tone also sounds, this means the CRUISE CONTROL has deactivated itself automatically (→ page 157).
 <p>--- km/h</p>	<ul style="list-style-type: none"> * The CRUISE CONTROL cannot be activated as not all activation conditions have been met. <ul style="list-style-type: none"> ► Observe the activation conditions of the CRUISE CONTROL (→ page 158).
<p>Active Distance Assist inoperative</p>	<ul style="list-style-type: none"> * The Active Distance Assist DISTRONIC is malfunctioning. Other driving systems and driving safety systems may also be malfunctioning. <ul style="list-style-type: none"> ► Visit a qualified specialist workshop.
<p>Active Distance Assist currently unavailable See Owner's Manual</p>	<ul style="list-style-type: none"> * The Active Distance Assist DISTRONIC is temporarily unavailable. The ambient conditions are outside the system limits (→ page 159).

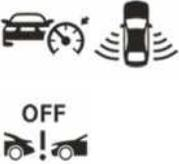
Display messages	Possible causes/consequences and ► Solutions
 <p>Currently unavailable Camera dirty</p>	<p>► Continue driving. When the ambient conditions are within the system limits, the system will be available again.</p> <p>* The camera view is reduced. Possible causes:</p> <ul style="list-style-type: none"> • dirt on the windscreen in the camera's field of vision • heavy precipitation or fog <p>Driving systems and driving safety systems may be malfunctioning or temporarily unavailable.</p> <p>When the causes have been eliminated, the driving systems and driving safety systems will be available again.</p> <p>If the display message does not disappear:</p> <ul style="list-style-type: none"> ► Stop in accordance with the traffic conditions. ► Clean the windscreen. ► If necessary, visit a qualified specialist workshop.
 <p>Currently unavailable Radar sensors dirty</p>	<p>* The radar sensor system is malfunctioning. Possible causes:</p> <ul style="list-style-type: none"> • dirt on the sensors • heavy precipitation • extended country drives without other traffic, e.g. in the desert <p>The following systems may be affected:</p> <ul style="list-style-type: none"> • Active Distance Assist DISTRONIC (→ page 159) • Blind Spot Assist (→ page 170) • Active Brake Assist (→ page 155) <p>Driving systems and driving safety systems may be malfunctioning or temporarily unavailable.</p> <p>When the causes have been eliminated, the driving systems and driving safety systems will be available again.</p> <p>If the display message does not disappear:</p> <ul style="list-style-type: none"> ► Stop in a safe location. ► Clean all sensors (→ page 287). ► Re-start the engine. ► If necessary, visit a qualified specialist workshop.
<p>Active Distance Assist available again</p>	<p>* The Active Distance Assist DISTRONIC is operational again and can be activated (→ page 161).</p>
 <p>Off</p>	<p>* The HOLD function has been deactivated because the vehicle is slipping or an activation condition has not been met.</p> <ul style="list-style-type: none"> ► Re-activate the HOLD function later on or check the HOLD function's activation conditions (→ page 162).
<p>Traffic Sign Assist inoperative</p>	<p>* The Traffic Sign Assist is malfunctioning.</p> <ul style="list-style-type: none"> ► Visit a qualified specialist workshop.
	<p>* The camera view is reduced. Possible causes:</p> <ul style="list-style-type: none"> • dirt on the windscreen in the camera's field of vision

Display messages	Possible causes/consequences and ► Solutions
<p>Traffic Sign Assist Camera view restricted See Owner's Manual</p>	<ul style="list-style-type: none"> • heavy precipitation or fog <p>Driving systems and driving safety systems may be malfunctioning or temporarily unavailable.</p> <p>When the causes have been eliminated, the driving systems and driving safety systems will be available again.</p> <p>If the display message does not disappear:</p> <ul style="list-style-type: none"> ► Stop in a safe location. ► Clean the windscreen.
<p>Traffic Sign Assist currently unavailable See Owner's Manual</p>	<p>* Traffic Sign Assist is temporarily unavailable (→ page 169).</p> <ul style="list-style-type: none"> ► Continue driving. When the causes have been eliminated, the system will be available again. <p>The windscreen is dirty. Clean the windscreen.</p>
<p>Blind Spot Assist inoperative</p>	<p>* Blind Spot Assist is malfunctioning (→ page 170).</p> <ul style="list-style-type: none"> ► Visit a qualified specialist workshop.
<p>Blind Spot Assist Trailer not monitored</p>	<p>* When you establish an electrical connection with the trailer, Blind Spot Assist will remain available but the area beside the trailer will not be monitored. The function of Blind Spot Assist may be restricted as a result (→ page 170).</p> <ul style="list-style-type: none"> ► Press the left-hand Touch Control and acknowledge the display message.
<p>Blind Spot Assist currently unavailable See Owner's Manual</p>	<p>* Blind Spot Assist is temporarily unavailable (→ page 170). The system limits have been reached (→ page 170).</p> <ul style="list-style-type: none"> ► Continue driving. When the causes have been eliminated, the system will be available again. <p>or</p> <ul style="list-style-type: none"> ► If the display message does not go out, stop in a safe location and re-start the engine. ► If necessary, clean the rear bumper. If the bumper is very dirty, the sensors in the bumper may malfunction.
<p>Active Lane Keeping Assist Camera view restricted See Owner's Manual</p>	<p>* The camera view is reduced (→ page 173). Possible causes:</p> <ul style="list-style-type: none"> • dirt on the windscreen in the camera's field of vision • heavy precipitation or fog <p>Driving systems and driving safety systems may be malfunctioning or temporarily unavailable.</p> <p>When the causes have been eliminated, the driving systems and driving safety systems will be available again.</p> <p>If the display message does not disappear:</p> <ul style="list-style-type: none"> ► Stop in a safe location. ► Clean the windscreen.

Display messages	Possible causes/consequences and ► Solutions
Active Lane Keeping Assist inoperative	* Active Lane Keeping Assist is malfunctioning (→ page 173). ► Visit a qualified specialist workshop.
Active Lane Keeping Assist currently unavailable See Owner's Manual	* Active Lane Keeping Assist is temporarily unavailable (→ page 173). The ambient conditions are outside the system limits (→ page 173). ► Continue driving. When the ambient conditions are within the system limits, the system will be available again. If the display message does not disappear: ► Stop in a safe location. ► Clean the windscreen.
 ATTENTION ASSIST inoperative	* The ATTENTION ASSIST is malfunctioning. ► Visit a qualified specialist workshop.
 ATTENTION ASSIST: Take a break!	* The ATTENTION ASSIST has detected fatigue or increasing inattentiveness on the driver's part (→ page 168). ► If necessary, take a break.

Engine

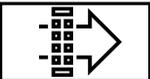
Display messages	Possible causes/consequences and ► Solutions
 Reserve fuel level	* The fuel supplies have reached the reserve level. ► Refuel.
 Replace air cleaner	* Vehicles with a diesel engine: The engine air filter is clogged and must be replaced. ► Visit a qualified specialist workshop.
 Coolant temperature high	* The fan motor is faulty. ► Without a high engine load, continue to the nearest qualified specialist workshop. Ensure that the coolant temperature display remains below 120 °C.
 Clean the fuel filter	* The water that has accumulated in the water separator has reached the maximum level. ► Drain the water separator (→ page 284).

Display messages	Possible causes/consequences and ► Solutions
 <p>Engine oil level cannot be measured</p>	<p>* The electrical connection to the oil level sensor has been interrupted or the oil level sensor is faulty. The engine oil level has fallen to the minimum level.</p> <p>► Visit a qualified specialist workshop.</p>
 <p>Engine oil pressure Stop Switch off engine</p>	<p>* Display message for certain engines only: The engine oil pressure is too low.</p> <div style="border: 1px solid black; padding: 5px; margin-bottom: 5px;"> <p>! NOTE Engine damage caused by driving with insufficient engine oil pressure</p> <p>► Avoid driving with insufficient engine oil pressure.</p> </div> <p>► Stop in a safe location immediately. Do not continue driving! ► Consult a qualified specialist workshop.</p>
 <p>Add 1 litre engine oil when next refuelling</p>	<p>* Display message for certain engines only: The engine oil level has fallen to the minimum level.</p> <div style="border: 1px solid black; padding: 5px; margin-bottom: 5px;"> <p>! NOTE Engine damage caused by driving with insufficient engine oil</p> <p>► Avoid long journeys with insufficient engine oil.</p> </div> <p>► Check the engine oil level at the next fuel stop. Top up engine oil (→ page 281). Observe the notes on engine oil (→ page 353).</p>
 <p>Engine oil level Reduce oil level</p>	<p>* Display message for certain engines only: The engine oil level is too high.</p> <div style="border: 1px solid black; padding: 5px; margin-bottom: 5px;"> <p>! NOTE Engine damage caused by driving with excess engine oil</p> <p>► Avoid long journeys with excess engine oil.</p> </div> <p>► Visit a qualified specialist workshop immediately and have the engine oil suctioned off.</p>
 <p>Engine oil level Stop vehi- cle Switch engine off</p>	<p>* Display message for certain engines only: The engine oil level is too low.</p> <div style="border: 1px solid black; padding: 5px; margin-bottom: 5px;"> <p>! NOTE Engine damage caused by driving with insufficient engine oil</p> <p>► Avoid long journeys with insufficient engine oil.</p> </div> <p>► Stop in a safe location immediately. Do not continue driving! ► Switch off the engine. ► Check the engine oil level. Top up the engine oil (→ page 281).</p>

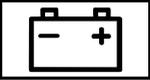
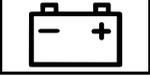
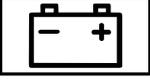
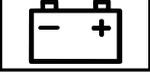
Display messages	Possible causes/consequences and ► Solutions
 <p data-bbox="87 290 311 338">Check eng. oil lev. when next refuelling</p>	<p data-bbox="383 162 815 188">Observe the notes on engine oil (→ page 353).</p> <p data-bbox="362 201 853 226">* The engine oil level has fallen to the minimum level.</p> <div data-bbox="383 242 1005 347" style="border: 1px solid black; padding: 5px;"> <p data-bbox="400 252 960 300">! NOTE Engine damage caused by driving with insufficient engine oil</p> <p data-bbox="396 316 864 341">► Avoid long journeys with insufficient engine oil.</p> </div> <p data-bbox="383 363 848 389">► Check the engine oil level at the next fuel stop.</p> <p data-bbox="383 405 680 430">Top up engine oil (→ page 281).</p> <p data-bbox="383 437 815 462">Observe the notes on engine oil (→ page 353).</p>
 <p data-bbox="87 568 259 616">Stop vehicle Leave engine running</p>	<p data-bbox="362 481 719 507">* The battery's charge level is too low.</p> <p data-bbox="383 513 965 539">► Stop in a safe location immediately. Do not continue driving!</p> <p data-bbox="383 545 591 571">► Let the engine run.</p> <p data-bbox="383 577 960 603">► Do not continue driving until the display message goes out.</p>
 <p data-bbox="87 727 293 775">Stop vehicle See Owner's Manual</p>	<p data-bbox="362 641 983 689">* The battery is no longer being charged and has reached an excessively low battery charge level.</p> <div data-bbox="383 705 1005 817" style="border: 1px solid black; padding: 5px;"> <p data-bbox="400 715 931 740">! NOTE Possible engine damage if you continue driving</p> <p data-bbox="396 756 887 782">► Do not continue driving under any circumstances.</p> <p data-bbox="396 788 797 813">► Consult a qualified specialist workshop.</p> </div> <p data-bbox="383 833 965 858">► Stop in a safe location immediately. Do not continue driving!</p> <p data-bbox="383 865 618 890">► Switch off the engine.</p> <p data-bbox="383 896 781 922">► Consult a qualified specialist workshop.</p>
 <p data-bbox="87 1031 293 1078">12 V battery See Owner's Manual</p>	<p data-bbox="362 944 893 970">* The engine is off and the battery charge level is too low.</p> <p data-bbox="383 976 904 1002">► Switch off electrical consumers that are not required.</p> <p data-bbox="383 1008 976 1082">► Let the engine run for a few minutes or drive an extended distance. The battery is charged.</p>
 <p data-bbox="87 1190 277 1216">See Owner's Manual</p>	<p data-bbox="362 1104 741 1129">* The battery is no longer being charged.</p> <div data-bbox="383 1136 1005 1248" style="border: 1px solid black; padding: 5px;"> <p data-bbox="400 1145 931 1171">! NOTE Possible engine damage if you continue driving</p> <p data-bbox="396 1187 887 1212">► Do not continue driving under any circumstances.</p> <p data-bbox="396 1219 797 1244">► Consult a qualified specialist workshop.</p> </div> <p data-bbox="383 1264 976 1289">► Stop in a safe location immediately and switch off the engine.</p> <p data-bbox="383 1295 781 1321">► Consult a qualified specialist workshop.</p>
 <p data-bbox="87 1430 277 1477">Coolant Stop vehicle Switch engine off</p>	<p data-bbox="362 1343 591 1369">* The coolant is too hot.</p> <p data-bbox="383 1375 976 1401">► Stop in a safe location immediately and switch off the engine.</p>

Display messages	Possible causes/consequences and ► Solutions
	<p>▲ WARNING Danger of burns when opening the bonnet</p> <p>If you open the engine bonnet when the engine has overheated or during a fire in the engine compartment, you could come into contact with hot gases or other escaping operating fluids.</p> <ul style="list-style-type: none"> ► Before opening the bonnet, allow the engine to cool down. ► In the event of a fire in the engine compartment, keep the engine bonnet closed and call the fire service. <p>▲ WARNING Risk of scalding from hot coolant</p> <p>The engine cooling system is pressurised, particularly when the engine is warm. If you open the cap, you could be scalded by hot coolant spraying out.</p> <ul style="list-style-type: none"> ► Let the engine cool down before opening the cap. ► When opening the cap, wear protective gloves and safety glasses. ► Open the cap slowly to release pressure. <ul style="list-style-type: none"> ► Wait until the engine has cooled down. ► Ensure that the air supply to the engine radiator is not obstructed. ► Without subjecting the engine to excessive strain, continue to the nearest qualified specialist workshop. Ensure that the coolant temperature display remains below 120 °C.
 <p>Top up coolant See Owner's Manual</p>	<p>* The coolant level is too low.</p> <p>▲ WARNING Risk of scalding from hot coolant</p> <p>The engine cooling system is pressurised, particularly when the engine is warm. If you open the cap, you could be scalded by hot coolant spraying out.</p> <ul style="list-style-type: none"> ► Let the engine cool down before opening the cap. ► When opening the cap, wear protective gloves and safety glasses. ► Open the cap slowly to release pressure. <p>! NOTE Engine damage due to insufficient coolant</p> <ul style="list-style-type: none"> ► Avoid long journeys with insufficient coolant. <ul style="list-style-type: none"> ► Top up coolant (→ page 282).
<p>Regeneration not possible</p>	<p>* Not all conditions have been met for regeneration of the diesel particulate filter (→ page 126).</p> <ul style="list-style-type: none"> ► Continue driving as normal until all conditions have been met for regeneration of the diesel particulate filter. <p>The load condition of the diesel particulate filter is over 50 % and the message still appears on the instrument cluster.</p>

Display messages	Possible causes/consequences and ► Solutions
	<ul style="list-style-type: none"> ► Visit a qualified specialist workshop.

AdBlue® (vehicles with passenger car registration)

Display messages	Possible causes/consequences and ► Solutions
 <p>Refill AdBlue See Owner's Manual</p>	<ul style="list-style-type: none"> * The AdBlue® level has fallen below the reserve range. <ul style="list-style-type: none"> ► Top up at least 8 l of AdBlue® immediately (→ page 142).
 <p>Top up AdBlue Perf. reduced in XXX miles See Owner's Manual</p>	<ul style="list-style-type: none"> * The low AdBlue® level will lead to a speed restriction once the remaining distance displayed has been covered. <ul style="list-style-type: none"> ► Top up at least 8 l of AdBlue® immediately (→ page 142).
 <p>Top up AdBlue Perf. reduced: 12 mph No start in XXX miles</p>	<ul style="list-style-type: none"> * The low AdBlue® level will restrict the speed to a maximum of 20 km/h. After the displayed remaining distance has been covered, it will no longer be possible to start the engine. <ul style="list-style-type: none"> ► Top up at least 8 l of AdBlue® immediately (→ page 142).
 <p>Refill AdBlue No start in XXX miles</p>	<ul style="list-style-type: none"> * The AdBlue® level is only sufficient for the displayed distance. <ul style="list-style-type: none"> ► Top up at least 8 l of AdBlue® immediately (→ page 142). ⓘ The message disappears after driving at a speed above 15 km/h for approximately one minute.
 <p>Refill AdBlue Start not possible</p>	<ul style="list-style-type: none"> * The AdBlue® tank is empty. You can no longer start the engine. <ul style="list-style-type: none"> ► Top up at least 8 l of AdBlue® immediately (→ page 142). ► Switch the ignition on. You can restart the engine after approximately one minute.
 <p>System fault No start in XXX miles</p>	<ul style="list-style-type: none"> * The AdBlue® system is malfunctioning. After the remaining distance displayed has been covered, it will no longer be possible to start the engine. <ul style="list-style-type: none"> ► Visit a qualified specialist workshop immediately.
 <p>AdBlue system fault See Owner's Manual</p>	<ul style="list-style-type: none"> * The AdBlue® system is malfunctioning. <ul style="list-style-type: none"> ► Consult a qualified specialist workshop immediately.

Display messages	Possible causes/consequences and ► Solutions
 <p>Cannot measure fluid level</p>	<p>* If an AdBlue® system malfunction occurs, no tank fill level is displayed on the service menu. The AdBlue® system malfunction is indicated by the relevant warning messages.</p> <p>► Consult a qualified specialist workshop.</p>
 <p>AdBlue system fault Perf. reduced in XXX miles See Owner's Manual</p>	<p>* The AdBlue® system is malfunctioning. The system malfunction will lead to a speed restriction once the remaining distance displayed has been covered.</p> <p>► Consult a qualified specialist workshop immediately.</p>
 <p>AdBlue system fault Perf. reduced: 12 mph No start in XXX miles</p>	<p>* The AdBlue® system is malfunctioning. The system malfunction will restrict the speed to a maximum of 20 km/h. After the distance displayed has been covered, it will no longer be possible to start the engine.</p> <p>► Consult a qualified specialist workshop immediately.</p>
 <p>AdBlue system fault Engine start not possible</p>	<p>* The AdBlue® system is malfunctioning. You can no longer start the engine.</p> <p>► Consult a qualified specialist workshop immediately.</p>

AdBlue® (vehicles with lorry registration)

Display messages	Possible causes/consequences and ► Solutions
 <p>Refill AdBlue See Owner's Manual</p>	<p>* The AdBlue® level has fallen below the reserve mark.</p> <p>► Top up at least 8 l of AdBlue® immediately (→ page 142).</p>
 <p>Top up AdBlue Performance reduced</p>	<p>* The AdBlue® level has fallen below the reserve range. The power is restricted to 75% of the engine torque.</p> <p>► Top up at least 8 l of AdBlue® immediately (→ page 142).</p>
 <p>Top up AdBlue Performance reduced after eng. restart: 12 mph</p>	<p>* The next time the engine is started, the low AdBlue® level will restrict the speed to a maximum of 20 km/h.</p> <p>► Top up at least 8 l of AdBlue® immediately (→ page 142).</p>

Display messages	Possible causes/consequences and ► Solutions
 <p>Top up AdBlue Power reduced: 12 mph</p>	<p>* The level of AdBlue® consumption means that the speed will be restricted to a maximum of 20 km/h.</p> <ul style="list-style-type: none"> ► Top up at least 8 l of AdBlue® immediately (→ page 142). ► Switch on the ignition.
 <p>AdBlue system fault See Owner's Manual</p>	<p>* The AdBlue® system is malfunctioning.</p> <ul style="list-style-type: none"> ► Consult a qualified specialist workshop immediately.
 <p>AdBlue system fault Performance reduced</p>	<p>* The AdBlue® system is malfunctioning. The engine's power is restricted by limiting its maximum torque to 75 % of the value of fault-free operation.</p> <ul style="list-style-type: none"> ► Consult a qualified specialist workshop immediately.
 <p>AdBlue system fault Performance reduced after eng. restart: XXX mph</p>	<p>* The AdBlue® system is malfunctioning. The next time the engine is started, the system malfunction will restrict the speed to a maximum of 20 km/h.</p> <ul style="list-style-type: none"> ► Visit a qualified specialist workshop immediately.
 <p>AdBlue system fault Performance reduced: 12 mph</p>	<p>* The AdBlue® system is malfunctioning. The system malfunction will restrict the speed to a maximum of 20 km/h.</p> <ul style="list-style-type: none"> ► Inform a qualified specialist workshop immediately.

Tyres

Display messages	Possible causes/consequences and ► Solutions
<p>Tyre pressure monitor inoperative No wheel sensors</p>	<p>* The installed wheels do not have suitable tyre pressure sensors. The tyre pressure monitor has been switched off.</p> <ul style="list-style-type: none"> ► Install wheels with suitable tyre pressure sensors.
 <p>Wheel sens. missing</p>	<p>* The tyre pressure sensor signal is missing from one or more tyre(s). No pressure value is displayed for the tyre in question.</p> <ul style="list-style-type: none"> ► Have the faulty tyre pressure sensor replaced at a qualified specialist workshop.
<p>Tyre press. monitor currently unavailable</p>	<p>* There is interference from a powerful source of radio waves As a result, no signals from the tyre pressure sensors are received. The tyre pressure monitor is temporarily unavailable.</p> <ul style="list-style-type: none"> ► Continue driving. As soon as the cause has been eliminated, the tyre pressure monitor automatically switches on.

Display messages	Possible causes/consequences and ► Solutions
 <p data-bbox="109 252 292 276">Warning tyre defect</p>	<p data-bbox="387 161 1028 209">* The pressure in one or more tyres suddenly falls. The wheel position is shown.</p> <div data-bbox="406 225 1028 507" style="border: 1px solid gray; padding: 5px;"> <p data-bbox="423 236 994 260">▲ WARNING Risk of an accident from driving with a flat tyre</p> <p data-bbox="423 276 844 300">Flat tyres are dangerous in the following ways:</p> <ul data-bbox="428 308 978 392" style="list-style-type: none"> <li data-bbox="428 308 822 331">• The tyres can overheat and cause a fire. <li data-bbox="428 339 978 392">• - The driving characteristics, steering and braking may be greatly impaired. <p data-bbox="423 408 804 432">You could then lose control of the vehicle.</p> <ul data-bbox="423 440 743 496" style="list-style-type: none"> <li data-bbox="423 440 710 464">► Do not drive with a flat tyre. <li data-bbox="423 472 743 496">► Observe the notes on flat tyres. </div> <p data-bbox="406 523 796 547">Information about flat tyres (→ page 294).</p> <ul data-bbox="406 555 967 611" style="list-style-type: none"> <li data-bbox="406 555 967 579">► Stop the vehicle in accordance with the traffic conditions. <li data-bbox="406 587 586 611">► Check the tyres.
 <p data-bbox="109 719 232 743">Check tyre(s)</p>	<p data-bbox="387 632 1028 679">* The pressure in one or more tyres has fallen significantly. The wheel position is shown.</p> <div data-bbox="406 695 1028 1082" style="border: 1px solid gray; padding: 5px;"> <p data-bbox="423 707 1005 754">▲ WARNING Risk of an accident due to insufficient tyre pressure</p> <p data-bbox="423 770 975 794">Tyres with insufficient tyre pressure pose the following risks:</p> <ul data-bbox="428 802 1009 967" style="list-style-type: none"> <li data-bbox="428 802 953 850">• The tyres may burst, especially as the load and vehicle speed increase. <li data-bbox="428 858 1009 906">• The tyres may wear excessively and/or unevenly, which may greatly impair tyre traction. <li data-bbox="428 914 978 967">• - The driving characteristics, steering and braking may be greatly impaired. <p data-bbox="423 983 804 1007">You could then lose control of the vehicle.</p> <ul data-bbox="423 1015 844 1070" style="list-style-type: none"> <li data-bbox="423 1015 844 1038">► Observe the recommended tyre pressures. <li data-bbox="423 1046 796 1070">► Adjust the tyre pressure if necessary. </div> <ul data-bbox="406 1098 922 1153" style="list-style-type: none"> <li data-bbox="406 1098 860 1121">► Stop in accordance with the traffic conditions. <li data-bbox="406 1129 922 1153">► Check the tyre pressure (→ page 313) and the tyres.
 <p data-bbox="109 1262 300 1286">Rectify tyre pressure</p>	<p data-bbox="387 1174 1009 1222">* The pressure in at least one tyre is too low or the pressures of the individual tyres deviate too much from each other.</p> <ul data-bbox="406 1230 1016 1313" style="list-style-type: none"> <li data-bbox="406 1230 893 1254">► Check the tyre pressure, and add air if necessary. <li data-bbox="406 1262 1016 1313">► When the tyre pressure has been set correctly, re-start the tyre pressure monitor (→ page 329).
<p data-bbox="109 1334 314 1382">Tyre pressure monitor inoperative</p>	<p data-bbox="387 1334 807 1358">* The tyre pressure monitor is malfunctioning.</p> <ul data-bbox="406 1366 770 1390" style="list-style-type: none"> <li data-bbox="406 1366 770 1390">► Visit a qualified specialist workshop.

Key

Display messages	Possible causes/consequences and ► Solutions
 <p>Place the key in the marked space See Owner's Manual</p>	<p>* Key detection is malfunctioning.</p> <ul style="list-style-type: none"> ► Change the key's position in the vehicle. ► Start the vehicle with the key in the slot(→ page 115).
 <p>Key not detected (red display message)</p>	<p>* The key is not detected and may no longer be in the vehicle. The key is no longer in the vehicle and you switch the engine off:</p> <ul style="list-style-type: none"> • You can no longer start the engine. • You cannot lock the vehicle centrally. <p>► Ensure that the key is in the vehicle.</p> <p>If the key detection function has a malfunction due to a strong radio signal source, proceed as follows:</p> <ul style="list-style-type: none"> ► Stop the vehicle immediately, paying attention to road and traffic conditions. ► Place the key in the slot for starting with the key (→ page 115).
 <p>Key not detected (white display message)</p>	<p>* The key is currently not detected.</p> <ul style="list-style-type: none"> ► Change the key's position in the vehicle. ► If the key is still not detected, start the engine with the key in the slot(→ page 115).
 <p>Change key batteries</p>	<p>* The key's battery is flat.</p> <ul style="list-style-type: none"> ► Change the battery (→ page 46).
 <p>Replace key</p>	<p>* The key must be replaced.</p> <ul style="list-style-type: none"> ► Visit a qualified specialist workshop.

Vehicle

Display messages	Possible causes/consequences and ► Solutions
 <p>Top up washer fluid</p>	<p>* Washer fluid level in washer reservoir has fallen below the minimum.</p> <ul style="list-style-type: none"> ► Top up washer fluid (→ page 283).
	<p>* At least one door is open.</p> <ul style="list-style-type: none"> ► Close all the doors.
	<p>* The bonnet is open.</p>

Display messages	Possible causes/consequences and ► Solutions
	<p>▲ WARNING Risk of accident due to driving with the engine bonnet unlocked</p> <p>An unlocked engine bonnet may open up when the vehicle is in motion and block your view.</p> <ul style="list-style-type: none"> ► Never unlock the engine bonnet when driving. ► Before every trip, ensure that the engine bonnet is locked. <ul style="list-style-type: none"> ► Stop in a safe location immediately. ► Close the bonnet.
 <p>inoperative See Owner's Man.</p>	<ul style="list-style-type: none"> * Stationary heating is temporarily malfunctioning. ► When the vehicle is at a standstill in a horizontal position and the engine has cooled down: try to switch on the stationary heating four times, leaving a gap of several minutes between each attempt. ► If the stationary heating does not switch on: visit a qualified specialist workshop.
 <p>inoperative Refuel vehicle</p>	<ul style="list-style-type: none"> * There is too little fuel in the fuel tank. The stationary heating cannot be switched on. ► Refuel the vehicle.
 <p>inoperative Battery low</p>	<ul style="list-style-type: none"> * The on-board voltage is too low. The stationary heating has switched off. ► Drive an extended distance until the battery has been sufficiently charged again.
 <p>Before starting the engine, turn the steering wheel.</p>	<ul style="list-style-type: none"> * Vehicles with manual transmissions: the electric steering lock was unable to unlock the steering. ► Switch off the ignition. ► To unlock the steering, move the steering wheel slightly to the left and right. ► Switch the ignition back on.
 <p>Steering malfunction Increased physical effort See Owner's Manual</p>	<ul style="list-style-type: none"> * The steering power assistance is malfunctioning. <p>▲ WARNING Risk of an accident due to altered steering characteristics</p> <p>If the power assistance of the steering fails partially or completely, you will need to use more force to steer.</p> <ul style="list-style-type: none"> ► If safe steering is possible, drive on carefully. ► Visit or consult a qualified specialist workshop immediately. <ul style="list-style-type: none"> ► If safe steering is possible, drive on carefully. ► Visit or consult a qualified specialist workshop immediately.

Display messages	Possible causes/consequences and ► Solutions
 <p>Steering malfunction Stop immediately See Owner's Manual</p>	<p>* The steering is malfunctioning. Steerability is heavily impaired.</p> <div style="border: 1px solid black; padding: 5px; margin: 5px 0;"> <p>▲ WARNING Risk of accident if steering capability is impaired</p> <p>If the steering does not function as intended, the vehicle's operating safety is jeopardised.</p> <ul style="list-style-type: none"> ▶ Pull over and stop the vehicle safely as soon as possible, paying attention to road and traffic conditions. Do not continue driving under any circumstances. ▶ Consult a qualified specialist workshop. </div> <ul style="list-style-type: none"> ▶ Stop in a safe location immediately. Do not continue driving! ▶ Consult a qualified specialist workshop.
<p>To start engine, shift to either P or N</p>	<p>* You have attempted to start the engine in transmission position D or R.</p> <ul style="list-style-type: none"> ▶ Shift the transmission to position P or N.
<p>Apply brake to select R</p>	<p>* You have tried to shift from position D or N to position R.</p> <ul style="list-style-type: none"> ▶ Press the brake pedal. ▶ Shift the transmission to position R.
<p>Air conditioning Malfunction See Owner's Manual</p>	<p>* The climate control system is functional, subject to temporary restrictions. The air quantity and fresh air supply are controlled automatically.</p> <ul style="list-style-type: none"> ▶ Have the climate control system checked at a qualified specialist workshop.
<p>Auxiliary battery malfunction</p>	<p>* The backup battery for the transmission is not being charged.</p> <ul style="list-style-type: none"> ▶ Visit a qualified specialist workshop. ▶ Until then, always shift the transmission to position P manually before you switch off the engine. ▶ Before leaving the vehicle, apply the parking brake.
<p>Reversing not poss. Consult workshop</p>	<p>* The transmission is malfunctioning. It is no longer possible to shift to reverse gear.</p> <ul style="list-style-type: none"> ▶ Visit a qualified specialist workshop.
<p>Transmission Malfunction Stop</p>	<p>* The transmission is malfunctioning. The transmission automatically shifts to position N.</p> <ul style="list-style-type: none"> ▶ Stop in a safe location immediately. ▶ Shift the transmission to position P. ▶ Consult a qualified specialist workshop.
 <p>Vehicle is operational Switch off the ignition before exiting</p>	<p>* You are about to exit the vehicle while it is ready to start.</p> <ul style="list-style-type: none"> ▶ When you exit the vehicle, switch off the ignition and take the key with you. ▶ If you do not exit the vehicle, switch off the electrical consumers, e.g. the seat heating. Otherwise, the 12-Volt-battery may discharge and the vehicle can only be started using a booster battery (jump start).

Display messages	Possible causes/consequences and ► Solutions
Without changing gear, consult workshop	<ul style="list-style-type: none"> * The transmission is malfunctioning. The transmission position can no longer be changed. <ul style="list-style-type: none"> ► If the transmission is in position D, visit a qualified specialist workshop, without changing the transmission position. ► For all other transmission positions, park the vehicle in a safe location. ► Consult a qualified specialist workshop.
Only select Park (P) when vehicle is stationary	<ul style="list-style-type: none"> * The transmission can only be brought into position P if the vehicle is at a standstill.
N permanently active Risk of vehicle rolling	<ul style="list-style-type: none"> * While the vehicle is rolling or driving, the transmission was shifted to position N. <ul style="list-style-type: none"> ► To stop, press the brake pedal and, when the vehicle is at a standstill, shift the transmission to position P. ► To continue driving, shift the transmission to position D or R.
Risk of vehicle rolling Driver door open and transmission not in P	<ul style="list-style-type: none"> * The driver's door is not fully closed and the transmission is in position R, N or D. <ul style="list-style-type: none"> ► When parking the vehicle, shift the transmission to position P.
To shift out of P or N, depress brake and start engine	<ul style="list-style-type: none"> * Vehicles with front-wheel drive: You have tried to shift to a different transmission position from position P or N. <ul style="list-style-type: none"> ► Press the brake pedal. ► Start the engine.
Apply brake to deselect Park (P) position	<ul style="list-style-type: none"> * You have tried to shift to a different transmission position from position P. <ul style="list-style-type: none"> ► Press the brake pedal.
 <p>Vehicle locating has been activated. Details: see manual or associated mobile app. or vehicle locating activated – see manual or mobile app.</p>	<ul style="list-style-type: none"> * The vehicle features activated services from Mercedes PRO. Locating the vehicle may be possible as part of Mercedes PRO connect. <ul style="list-style-type: none"> ► Check the status of the activated services at http://mercedes.pro. ► Ask the vehicle owner for the details.
 <p>Step not extended See Owner's Manual or step not extended malfunction</p>	<ul style="list-style-type: none"> * The electrical step is not, or only partially, extended. <ul style="list-style-type: none"> ► Ensure there is sufficient clearance for the electrical step. ► Open or close the sliding door again. ► If the electrical step does not completely extend again, slide it in manually (emergency release) (→ page 56). ► Inform passengers that the step is missing before they exit the vehicle.
	<ul style="list-style-type: none"> * The electrical step is not, or only partially, retracted. <ul style="list-style-type: none"> ► Ensure there is sufficient clearance for the electrical step.

Display messages	Possible causes/consequences and ► Solutions
Step not retracted See Owner's Manual or step not retracted malfunction	<ul style="list-style-type: none"> ► Open or close the sliding door again. ► If the electrical step does not completely retract again, slide it in manually (emergency release) (→ page 56).

Lights

Display messages	Possible causes/consequences and ► Solutions
Adaptive Highbeam Assist Camera view restricted See Owner's Manual	<p>* The camera view is reduced. Possible causes:</p> <ul style="list-style-type: none"> • Dirt on the windscreen in the camera's field of vision • Heavy precipitation or fog <p>Driving systems and driving safety systems may be malfunctioning or temporarily unavailable.</p> <p>When the causes have been eliminated, the driving systems and driving safety systems are available again.</p> <p>If the display message does not go out:</p> <ul style="list-style-type: none"> ► Stop in a safe location. ► Clean the windscreen.
Adaptive Highbeam Assist currently unavailable See Owner's Manual	<p>* Adaptive Highbeam Assist is temporarily unavailable. The system limits have been reached (→ page 88).</p> <ul style="list-style-type: none"> ► Continue driving. When the causes have been eliminated, the system will be available again. The display message Adaptive Highbeam Assist available again appears.
Adaptive Highbeam Assist inoperative	<p>* Adaptive Highbeam Assist is malfunctioning.</p> <ul style="list-style-type: none"> ► Visit a qualified specialist workshop.
 Switch on headlamps	<p>* You are driving without a dipped beam.</p> <ul style="list-style-type: none"> ► Turn the light switch to position . <p>or</p> <ul style="list-style-type: none"> ► Turn the light switch to the AUTO position.
 Switch off lights	<p>* You are leaving the vehicle and the light is still switched on.</p> <ul style="list-style-type: none"> ► Turn the light switch to position AUTO.
 AUTO lights inoperative	<p>* The light sensor is malfunctioning.</p> <ul style="list-style-type: none"> ► Visit a qualified specialist workshop.
 Malfunction See Owner's Manual	<p>* The exterior lighting is malfunctioning.</p> <ul style="list-style-type: none"> ► Visit a qualified specialist workshop. <p>Vehicles with trailer hitch: a fuse may have blown.</p> <ul style="list-style-type: none"> ► Stop in accordance with the traffic conditions. ► Check the fuses, and replace them if necessary(→ page 308).

Display messages	Possible causes/consequences and ► Solutions
 <p>Left dipped beam (example)</p>	<p>* The bulb in question is faulty.</p> <ul style="list-style-type: none"> ► Visit a qualified specialist workshop. or ► Check whether changing the bulb is permitted.

Warning and indicator lamps

Overview of warning and indicator lamps

When the ignition is switched on, many systems perform a self-test. Some warning and indicator lamps may switch on or flash temporarily during this time. This behaviour is no cause for alarm. These warning and indicator lamps only signal a malfunction if they light up or flash, once the engine has been started or the vehicle is in operation.

Warning and indicator lamps:

-  Dipped beam(→ page 86)
-  Standing light(→ page 86)
-  High beam(→ page 87)
-  Indicator(→ page 87)
-  Rear fog light(→ page 86)
-  Safety belt not fastened(→ page 387)
-  Brakes (red)(→ page 382)
-  Brakes (yellow)(→ page 382)
-  ABS malfunctioning(→ page 382)

-  Cross-country gear
-  ESP®(→ page 382)
-  ESP® OFF (→ page 382)
-  Active Brake Assist deactivated(→ page 155)
-  Electric parking brake applied (red) (→ page 382) (→ page 382)
-  Electric parking brake (yellow) (→ page 382) (→ page 382)
-  Power-assisted steering malfunctioning(→ page 387)
-  Electrical fault(→ page 388)
-  Restraint system(→ page 382)
-  Engine diagnosis(→ page 388)
-  Fuel reserve with fuel filler flap location indicator(→ page 388)
-  Coolant too hot/cold (→ page 388)
-  Distance warning(→ page 387)
-  Preglow
-  Tyre pressure monitor

Safety systems

Warning/indicator lamp	Possible causes/consequences and ► Solutions
 <p>Electric parking brake applied red indicator lamp lights up</p>  <p>Electric parking brake malfunctioning yellow indicator lamp lights up</p>	<p>Vehicles with electric parking brake: the electric parking brake red indicator lamp does not light up. The electric parking brake yellow indicator lamp lights up.</p> <p>Meaning of the indicator lamps:</p> <ul style="list-style-type: none"> • The red indicator lamp does not light up: the electric parking brake has been released. • The yellow indicator lamp lights up: the electric parking brake is malfunctioning. <ul style="list-style-type: none"> ► Observe the messages on the multifunction display. ► Switch the ignition off and back on. ► If the fault message persists, visit a qualified specialist workshop. ► Park the vehicle only on level ground and secure it against rolling away (→ page 148).

Warning/indicator lamp	Possible causes/consequences and ► Solutions
 <p>Electric parking brake applied red indicator lamp lights up</p>  <p>Electric parking brake malfunctioning yellow indicator lamp lights up</p>	<p>Vehicles with electric parking brake: the red and yellow electric parking brake indicator lamps light up.</p> <p>Meaning of the indicator lamps:</p> <ul style="list-style-type: none"> • The electric parking brake red indicator lamp lights up: the electric parking brake has been applied. • The electric parking brake yellow indicator lamp lights up: the electric parking brake is malfunctioning. <p>► Switch the ignition off and back on.</p> <p>► If the error message persists, visit a qualified specialist workshop.</p> <p>► Observe the messages on the multifunction display.</p> <p>► If it is not possible to release the electric parking brake, do not drive the vehicle.</p>
 <p>Electric parking brake red indicator lamp engaged flashes</p>  <p>Electric parking brake malfunctioning yellow indicator lamp lights up</p>	<p>Vehicles with electric parking brake: the electric parking brake red indicator lamp flashes. The electric parking brake yellow indicator lamp lights up.</p> <p>Meaning of the indicator lamps:</p> <ul style="list-style-type: none"> • The electric parking brake red indicator lamp flashes: the activation status of the electric parking brake is unknown. • The electric parking brake yellow indicator lamp lights up: the electric parking brake is malfunctioning. <p>► Observe the messages on the multifunction display.</p> <p>► Switch the ignition off and back on.</p> <p>► Engage and disengage the electric parking brake using the switch while depressing the brake pedal.</p> <p>► If the fault message persists, park the vehicle on level ground and secure it against rolling away (→ page 148).</p> <p>► Consult a qualified specialist workshop.</p> <p>► Do not drive the vehicle when the red indicator lamp is flashing as the brake system may overheat.</p>
 <p>Electric parking brake applied red indicator lamp lights up</p>  <p>The electric parking brake malfunctioning yellow indicator lamp does not light up</p>	<p>Vehicles with electric parking brake: the electric parking brake red indicator lamp lights up. The electric parking brake yellow indicator lamp does not light up.</p> <p>Meaning of the indicator lamps:</p> <ul style="list-style-type: none"> • The electric parking brake red indicator lamp lights up: the electric parking brake has been applied. • The electric parking brake yellow indicator lamp does not light up: there are no faults with the electric parking brake. <p>► Do not drive the vehicle if the electric parking brake has been applied.</p>

Warning/indicator lamp	Possible causes/consequences and ► Solutions
 <p>Parking brake applied red indicator lamp lights up</p>	<p>Vehicles with manual parking brake: the parking brake red indicator lamp lights up.</p> <p>Meaning of the indicator lamp:</p> <ul style="list-style-type: none"> • The parking brake red indicator lamp lights up: the parking brake has been applied. <p>► Do not drive the vehicle if the parking brake has been applied.</p>
 <p>Brake system warning lamp (yellow)</p>	<p>The brake system yellow warning lamp lights up while the engine is on.</p> <p>▲ WARNING Risk of an accident due to a brake system malfunction</p> <p>If the brake system is malfunctioning, braking characteristics may be impaired.</p> <ul style="list-style-type: none"> ► Drive on carefully. ► Have the brake system checked immediately at a qualified specialist workshop. <p>► Drive carefully at an adjusted speed and at a sufficient distance from the vehicle in front.</p> <p>► If the multifunction display shows a display message, comply with it.</p> <p>► Visit a qualified specialist workshop.</p>
 <p>Brake system warning lamp (red)</p>	<p>The brake system red warning lamp lights up while the engine is on.</p> <p>Possible causes:</p> <ul style="list-style-type: none"> • The brake force boosting is malfunctioning. • The EBD (electronic brakeforce distribution) is malfunctioning. • There is not enough brake fluid in the brake fluid reservoir. <p>▲ WARNING Risk of accident and injury if brake force boosting is malfunctioning</p> <p>If brake force boosting is malfunctioning, increased brake pedal force may be necessary for braking. The braking characteristics may be impaired. The braking distance can increase in emergency braking situations.</p> <ul style="list-style-type: none"> ► Stop in a safe location immediately. Do not continue driving! ► Consult a qualified specialist workshop. <p>▲ WARNING Risk of an accident if the EBD (electronic brake force distribution) malfunctions</p> <p>If the EBD malfunctions, the wheels may lock during braking. The braking characteristics may be impaired. The braking distance can increase in emergency situations.</p> <ul style="list-style-type: none"> ► Stop in a safe location immediately. Do not continue driving! ► Consult a qualified specialist workshop.

Warning/indicator lamp	Possible causes/consequences and ► Solutions
	<p>▲ WARNING Risk of an accident due to low brake fluid level</p> <p>If the brake fluid level is too low, the braking effect and the braking characteristics may be impaired.</p> <ul style="list-style-type: none"> ► Stop the vehicle as soon as possible, paying attention to road and traffic conditions. Do not continue driving. ► Consult a qualified specialist workshop. ► Do not top up the brake fluid. <p>► Stop the vehicle immediately, paying attention to road and traffic conditions. Do not continue driving!</p> <p>► Consult a qualified specialist workshop.</p>
 <p>Restraint system warning lamp</p>	<p>The restraint system red warning lamp is on while the engine is on. The restraint system is malfunctioning.</p> <p>▲ WARNING Risk of injury due to malfunctions in the restraint system</p> <p>If the restraint system is malfunctioning, restraint system components may be triggered unintentionally or may not deploy as intended during an accident. This may affect the seat belt tensioner or airbag, for example.</p> <ul style="list-style-type: none"> ► Have the restraint system checked and repaired immediately at a qualified specialist workshop. <p>► Drive on carefully.</p> <p>► Observe the messages on the multifunction display.</p> <p>► Visit a qualified specialist workshop immediately.</p>
 <p>ESP® warning lamp lights up</p>	<p>The ESP® yellow warning lamp lights up while the engine is on. ESP® is malfunctioning.</p> <p>Other driving systems and driving safety systems may also be malfunctioning.</p> <p>▲ WARNING Risk of skidding if ESP® is malfunctioning</p> <p>If ESP® is malfunctioning, ESP® cannot carry out vehicle stabilisation. In addition, other driving safety systems are switched off.</p> <ul style="list-style-type: none"> ► Drive on carefully. ► Have ESP® checked at a qualified specialist workshop. <p>► Continue driving carefully.</p> <p>► Read the messages on the multifunction display.</p> <p>► Visit a qualified specialist workshop.</p>
	<p>The ESP® yellow warning lamp flashes during the trip. ESP® intervenes (→ page 153).</p> <p>► Adapt your driving style to the weather and road conditions.</p>

Warning/indicator lamp	Possible causes/consequences and ► Solutions
<p>ESP® warning lamp flashes</p>  <p>ESP® OFF warning lamp</p>	<p>The ESP® OFF yellow warning lamp lights up while the engine is on. ESP® has been switched off.</p> <p>▲ WARNING Risk of skidding when driving with ESP® deactivated</p> <p>If ESP® is deactivated, ESP® cannot carry out vehicle stabilisation. The availability of further driving safety systems is also limited.</p> <ul style="list-style-type: none"> ► Drive on carefully. ► Only deactivate ESP® for as long as the situation requires. <p>If ESP® cannot be activated, ESP® is malfunctioning.</p> <ul style="list-style-type: none"> ► Have ESP® checked immediately at a qualified specialist workshop. <p>► Comply with instructions to switch ESP® off (→ page 153).</p>
 <p>ABS warning lamp</p>	<p>The ABS yellow warning lamp lights up while the engine is on. ABS is malfunctioning.</p> <p>If an additional warning tone sounds, this means the EBD is malfunctioning.</p> <p>Other driving systems and driving safety systems may also be malfunctioning.</p> <p>▲ WARNING There is risk of skidding if EBD or ABS is malfunctioning</p> <p>If EBD or ABS is malfunctioning, the wheels could lock when braking. The steering capability and braking characteristics are thus severely impaired. The braking distance may increase in an emergency braking situation. In addition, other driving safety systems are switched off.</p> <ul style="list-style-type: none"> ► Drive on carefully. ► Have the brake system checked immediately at a qualified specialist workshop. <ul style="list-style-type: none"> ► Continue driving carefully. ► Read the messages on the multifunction display. ► Visit a qualified specialist workshop.

Seat belt

Warning/indicator lamp	Possible causes/consequences and ► Solutions
 <p data-bbox="87 316 300 363">Seat belt warning lamp flashes</p>	<p data-bbox="350 228 997 276">The seat belt red warning lamp flashes and an intermittent warning tone sounds.</p> <p data-bbox="350 284 997 331">The driver or front passenger does not have their belt on during the trip (speeds above 25 km/h).</p> <ul style="list-style-type: none"> <li data-bbox="350 339 692 363">► Put on the seat belt (→ page 34). <li data-bbox="350 371 770 395">There are objects on the front passenger seat. <li data-bbox="350 403 848 427">► Remove the objects from the front passenger seat.
 <p data-bbox="87 531 300 579">Seat belt warning lamp lights up</p>	<p data-bbox="350 443 983 491">The seat belt red warning lamp lights up once the engine has started. A warning tone may also sound.</p> <p data-bbox="350 499 997 547">When the vehicle is stationary: The seat belt warning lamp reminds drivers and front passengers to put on their seat belt.</p> <ul style="list-style-type: none"> <li data-bbox="350 555 725 579">► Putting on the seat belt (→ page 34). <p data-bbox="350 603 994 643">Objects on the front passenger seat may prevent the seat belt warning lamp from going out.</p>

Driving systems

Warning/indicator lamp	Possible causes/consequences and ► Solutions
 <p data-bbox="87 906 300 954">Distance warning warning lamp</p>	<p data-bbox="350 818 994 866">The red distance warning lamp lights up while the vehicle is in motion. The distance to the vehicle in front is too close for the selected speed.</p> <p data-bbox="350 874 994 922">If an additional warning tone sounds, this means you are approaching an obstacle at excessive speed.</p> <ul style="list-style-type: none"> <li data-bbox="350 930 764 954">► Be ready to apply the brakes immediately. <li data-bbox="350 962 585 986">► Increase the distance.

Vehicle

Warning/indicator lamp	Possible causes/consequences and ► Solutions
 <p data-bbox="87 1248 300 1295">Power steering system warning lamp</p>	<p data-bbox="350 1160 997 1208">The red power steering system warning lamp lights up while the engine is running.</p> <p data-bbox="350 1216 983 1240">The power steering assistance or the steering itself is malfunctioning.</p> <div style="border: 1px solid black; padding: 5px; margin-top: 10px;"> <p data-bbox="361 1264 955 1287">▲ WARNING Risk of accident if steering capability is impaired</p> <p data-bbox="361 1303 986 1351">If the steering no longer functions as intended, the vehicle's operating safety is jeopardised.</p> <ul style="list-style-type: none"> <li data-bbox="361 1359 762 1383">► Consult a qualified specialist workshop. </div> <ul style="list-style-type: none"> <li data-bbox="350 1407 826 1431">► Read the messages on the multifunction display.

Engine

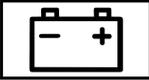
Warning/indicator lamp	Possible causes/consequences and ► Solutions
 <p data-bbox="109 316 311 339">Coolant warning lamp</p>	<p data-bbox="371 225 983 248">The red coolant warning lamp lights up while the engine is running.</p> <p data-bbox="371 256 524 280">Possible causes:</p> <ul data-bbox="371 292 804 416" style="list-style-type: none"> • temperature sensor malfunctioning • coolant level too low • air supply to the engine radiator obstructed • engine radiator fan faulty <p data-bbox="371 432 1009 480">If a warning tone also sounds, the coolant has exceeded the temperature of 120 °C.</p> <div data-bbox="371 496 1031 719" style="border: 1px solid gray; padding: 5px;"> <p data-bbox="383 504 919 528">▲ WARNING Danger of burns when opening the bonnet</p> <p data-bbox="383 544 997 616">If you open the engine bonnet when the engine has overheated or during a fire in the engine compartment, you could come into contact with hot gases or other escaping operating fluids.</p> <ul data-bbox="383 627 953 711" style="list-style-type: none"> ► Before opening the bonnet, allow the engine to cool down. ► In the event of a fire in the engine compartment, keep the engine bonnet closed and call the fire service. </div> <ul data-bbox="371 735 981 820" style="list-style-type: none"> ► Stop immediately in accordance with the traffic conditions and switch off the engine. Do not continue driving! ► Observe the messages on the multifunction display. <p data-bbox="371 842 1003 890">If the coolant temperature display is at the lower end of the temperature scale:</p> <ul data-bbox="371 901 768 925" style="list-style-type: none"> ► Consult a qualified specialist workshop. <p data-bbox="371 949 471 973">Otherwise:</p> <ul data-bbox="371 984 1031 1182" style="list-style-type: none"> ► Leave the vehicle and keep a safe distance from the vehicle until the engine has cooled down. ► Check the coolant level(→ page 282). ► Ensure that the air supply to the engine radiator is not obstructed. ► Without subjecting the engine to excessive strain, continue to the nearest qualified specialist workshop. Ensure that the coolant temperature display remains below 120 °C.
 <p data-bbox="109 1289 322 1337">Electrical fault warning lamp</p>	<p data-bbox="371 1201 792 1225">The electrical fault red warning lamp lights up.</p> <p data-bbox="371 1233 770 1257">A malfunction has occurred in the electrics.</p> <ul data-bbox="371 1265 848 1289" style="list-style-type: none"> ► Read the messages on the multifunction display.
 <p data-bbox="109 1442 303 1490">Fuel reserve warning lamp</p>	<p data-bbox="371 1355 1003 1378">The fuel reserve yellow warning lamp lights up while the engine is on.</p> <p data-bbox="371 1386 815 1410">The fuel supplies have reached the reserve level.</p> <ul data-bbox="371 1418 471 1442" style="list-style-type: none"> ► Refuel.

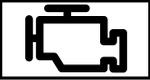
Warning/indicator lamp	Possible causes/consequences and ► Solutions
 <p>Engine diagnosis warning lamp</p>	<p>The engine diagnosis yellow warning lamp lights up while the engine is on.</p> <p>A malfunction has occurred in the engine, the exhaust system or the fuel system.</p> <p>The emissions limit value may have been exceeded and the engine may be running in emergency operation mode.</p> <p>► Have the vehicle checked as soon as possible at a qualified specialist workshop.</p>

Tyres

Warning/indicator lamp	Possible causes/consequences and ► Solutions
 <p>Tyre pressure monitoring system warning lamp flashes</p>	<p>The tyre pressure yellow monitor warning lamp (pressure loss / malfunction) flashes for roughly one minute and then lights up permanently.</p> <p>The tyre pressure monitor is malfunctioning.</p> <p>▲ WARNING There is a risk of an accident if the tyre pressure monitoring system is malfunctioning</p> <p>If the tyre pressure monitoring system is malfunctioning, it is not able to issue a warning if there is pressure loss in one or more of the tyres.</p> <p>Tyres with insufficient tyre pressure may, for example, affect the vehicle's handling characteristics, steering and braking. -</p> <p>► Have the tyre pressure monitoring system checked at a qualified specialist workshop.</p> <p>► Visit a qualified specialist workshop.</p>
 <p>Tyre pressure monitoring system warning lamp lights up</p>	<p>The tyre pressure monitor yellow warning lamp (pressure loss / malfunction) lights up.</p> <p>The tyre pressure monitor has detected a tyre pressure loss in at least one tyre.</p> <p>▲ WARNING Risk of an accident due to insufficient tyre pressure</p> <p>Tyres with insufficient tyre pressure pose the following risks:</p> <ul style="list-style-type: none"> • The tyres may burst, especially as the load and vehicle speed increase. • The tyres may wear excessively and/or unevenly, which may greatly impair tyre traction. • - The driving characteristics, steering and braking may be greatly impaired. <p>You could then lose control of the vehicle.</p> <p>► Observe the recommended tyre pressures.</p> <p>► Adjust the tyre pressure if necessary.</p>

Warning/indicator lamp	Possible causes/consequences and ► Solutions
	<ul style="list-style-type: none"><li data-bbox="370 183 717 209">► Stop the vehicle in a safe location.<li data-bbox="370 215 757 240">► Check the tyre pressure and the tyres.

1, 2, 3 ...	
12 V socket	
see Socket (12 V)	
230 V socket	82
230 V socket	
see Socket (230 V) (centre console, front)	
360° Camera	165
Care	287
Function	165
Selecting a view	167
Switching automatic operation on/off (reversing camera)	167
A	
ABS (Anti-lock Braking System)	152
Acceleration	
see Using kickdown	
Access data	
Setting (Bluetooth®)	259
Acoustic locking verification signal	
Activating/deactivating	46
Activating/deactivating air-recirculation mode	106
Activating/deactivating the rotating beacon	89
Activating/deactivating the synchronisation function (control panel)	105
Active Brake Assist	155
Function/notes	155
Setting	156
Active Distance Assist DISTRONIC	159
Calling up a speed	161
Function	159
Increasing/reducing the speed	161
Requirements:	161
Steering-wheel buttons	161
Storing a speed	161
Switching off/deactivating	161
Switching on/activating	161
System limitations	159
Active Lane Keeping Assist	173
Function	173
System limitations	173
Trailer operation	173
Active Parking Assist	
Manoeuvring assistance	167
Adaptive brake lights	157

Adaptive cruise control	
see Active Distance Assist DISTRONIC	
Adaptive Highbeam Assist	
Function	88
switching on/off	89
AdBlue®	141, 352
Additive	141, 352
Displaying the fill level	142
Filling capacity	352
Purity	141, 352
Range display	142
Topping up	142
Add-on equipment	23
Add-on equipment guidelines	23
Additional door lock	47
Additional turn signal light (all-wheel drive vehicles)	93
Additive	353
AdBlue®	141, 352
Engine oil	353
Additives (AdBlue®)	
see AdBlue®	
Additives (engine oil)	
see Additive	
Address book	
see Contacts	
ADR (working speed control)	
Adjusting	175
Function	175
Switching on/off	175
After-sales service centre	
see ASSYST PLUS	
Air nozzles	
see Air vents	
Air recirculation button	
Convenience opening/closing	106
Air vents	106, 107
adjusting (front)	106
adjusting (roof)	107
Rear	107
Airbag	35
Activation	32
Front airbag (driver, front passenger)	35
Installation locations	35
Overview	35
Protection	35
Reduced protection	36
Side impact airbag	35
Window airbag	35

- Alarm system**
 - see ATA (Anti-theft Alarm system)
- Alertness assistant**
 - see ATTENTION ASSIST
- All-wheel drive**
 - Engaging 132
 - Engaging/disengaging 132
 - LOW range 133
 - Notes 131
- Alternative route**
 - see Route
- Android Auto** 256
 - Connecting a mobile phone 256
 - Ending 257
 - Note 256
 - Overview 256
 - Sound settings 257
 - Transferred vehicle data 257
- Android Auto™**
 - Control using the application buttons 257
- Animals**
 - Pets in the vehicle 44
- Anti-lock braking system**
 - see ABS (Anti-Lock Braking System)
- Anti-skid chains**
 - see Snow chains
- Anti-theft Alarm system**
 - see ATA (Anti-theft Alarm system)
- Anti-theft protection**
 - Additional door lock 47
 - Immobiliser 61
- Anti-theft protection**
 - see ATA (Anti-theft Alarm system)
- Apple CarPlay™** 255
 - Connecting an iPhone® 255
 - Control using the application buttons 256
 - Ending 256
 - Notes 255
 - Overview 255
 - Sound settings 255
 - Transferred vehicle data 257
- Aquaplaning** 120
- Ashtrays**
 - in the windscreen stowage compartment 81
- ASR (acceleration skid control)** 153
- Assistance graphic (on-board computer)** 183
- ASSYST PLUS** 278
 - Battery disconnection periods 278
 - Displaying the service due date 278
 - Function/notes 278
 - Regular maintenance work 278
 - Special service requirements 278
- ATA (Anti-theft Alarm system)** 61
 - Function 61
 - Interior motion sensor function 62
 - Priming/deactivating the interior motion sensor 62
 - Stopping the alarm 61
 - Switching tow-away protection on/off 62
 - Tow-away protection function 61
- Attachments** 23
- ATTENTION ASSIST** 168, 169
 - Function 168
 - Setting 169
 - System limitations 168
- Authorised workshop**
 - see Qualified specialist workshop
- Automatic dipped beam** 86
- Automatic distance adjustment**
 - see Active Distance Assist DISTRONIC
- Automatic engine start (ECO start/stop function)** 124
- Automatic engine stop (ECO start/stop function)** 124
- Automatic transmission**
 - DIRECT SELECT lever 128
 - Engage park position 129
 - Engaging drive position 130
 - Engaging neutral 129
 - Engaging reverse gear 129
 - Kickdown 131
 - Restricting the shift range 130
 - Transmission position display 128
 - Transmission positions 128
- Auxiliary heating** 107
 - Function 107
- Auxiliary warm-air heater** 111
 - Immediate heating mode 112
 - Overview, timer 111
 - Problems 112
 - Setting the departure time 112
 - Setting the temperature/operating duration 112
 - Setting the timer 111
- Axle load** 348

- B**
- Back support**
see Lumbar support (4-way)
- Ball coupling**
attaching 177
- Ball neck**
Removing 178
- BAS (Brake Assist System)** 153
- Battery**
Charging 296
Charging a vehicle battery 296
Disconnecting the auxiliary battery in the engine compartment 302
Disconnecting the auxiliary battery under the co-driver seat 302
Disconnecting the starter battery 298
Jump-starting (vehicle) 296
Key 46
Notes (vehicle) 294
Remote control (stationary heating/ventilation) 110
Removing or fitting the starter battery 299
Starter battery 298
- Battery main switch**
Notes 126
Switching the power supply on/off .. 127
- Belt**
see Seat belt
- Blind Spot Assist** 170
Activating/deactivating 171
Function 170
Rear Cross Traffic Alert 172
System limitations 170
- Bluetooth®** 215
Information 214
Setting up an Internet connection 259
Switching on/off 215
- Bottle holder** 80
- Brake**
ABS (Anti-lock Braking System) 152
Active Brake Assist 155
Adaptive brake lights 157
BAS (Brake Assist System) 153
Braking with parking brake: 119
Downhill gradient 119
Driving tips 116
EBD (Electronic Brakeforce Distribution) 154
Heavy and light loads 119
HOLD function 162
New brake discs and brake pads/linings 119
New/replaced brakepads/brake discs 116
Restricted braking effect (salt-treated roads) 116
Running-in notes 116
Wet road surfaces 119
- Brake Assist System**
see BAS (Brake Assist System)
- Brake Assistance**
see BAS (Brake Assist System)
- Brake fluid**
Notes 355
- Brakeforce Distribution**
EBD (Electronic Brakeforce Distribution) 154
- Breakdown**
Changing a wheel 335
Overview of help 19
Tow starting 307
Towing away 304
Transporting the vehicle 306
- Breakdown**
see Flat tyre
- Bulbs**
Reversing light 95
- Buttons**
Steering wheel 181
- C**
- Call list**
Deleting 253
Making a call 253
Overview 252
Selecting options 253
- Calls** 249
Accepting 249
Activating functions during a call 250
Calls with several participants 250
Declining 249
Ending a call 249
Incoming call during an existing call 250
Making 249
- Camera**
see 360° Camera
see Reversing camera
- Car wash**
see Care
- Car wash (care)** 286

Car-to-X-Communication

Displaying hazard warnings	239
Overview	239
Sending hazard warnings	239

Care

Automatic car wash	286
Carpet	289
Display	289
Exterior lighting	287
High-pressure cleaner	286
Matt finish	287
Paint	287
Plastic trim	289
Real wood/trim elements	289
Reversing camera/360° Camera	287
Roof lining	289
Seat belt	289
Seat cover	289
Sensors	287
Tailpipes	287
Trailer hitch	287
Washing by hand	286
Wheels/rims	287
Windows	287
Wiper blades	287

Cargo compartment lighting

Motion detector	91
-----------------------	----

Cargo compartment ventilation

Deactivating	113
Setting	113

Carpet (care)**Change bulbs**

Additional turn signal light (all-wheel drive vehicles)	93
---	----

Changing a bulb

see Changing bulbs

Changing a wheel

Lowering the vehicle	340
Preparing	335
Raising the vehicle	336
Removing a wheel	338

Changing bulbs

Dipped beam	92
High beam	92
Indicator (front)	92
Indicators (rear) (panel van and crewbus)	94
Interior lamps (rear)	96
Licence plate lighting	95
Light bulb types halogen headlamps ..	92
Notes	92
Reversing lights (panel van and crewbus)	94

Side marker lamps	96
Tail lamp bulb types (chassis)	95
Tail lamp bulb types (panel van and crewbus)	93
Turn signal light (rear) (chassis)	95

Changing lamps

see Changing bulbs

Charging

Battery	296
Mobile phone (wireless)	83

Child safety lock (doors)**Child seat**

Attaching (notes)	41
Front passenger seat (notes)	40
Front passenger seat (rearward-facing/forward-facing)	40
ISOFIX (fitting)	38
ISOFIX (notes)	38
Notes on the safe transportation of children	36
Rearward-facing child restraint system (Information)	40
Recommended child restraint systems	43
Seats suitable for belt-secured child restraint systems	41
Top Tether	39

Children

Notes on safe transportation	36
------------------------------------	----

Chock (rear wheel drive)**Cigarette lighter****Cleaning**

see Care

Cleaning water drain valve of the air**intake box****Climate control**

Activating/deactivating	103
Activating/deactivating air-recirculation mode	106
Activating/deactivating the synchronisation function (control panel)	105
Air distribution settings	105
automatically controlling (rear)	104
Auxiliary heating	107
Cargo compartment ventilation	113
Demisting the windows	105
Hot-water auxiliary heater	108
Refrigerant	356
Setting automatic mode	104
Setting the air distribution	105

- Setting the rear compartment heating 104
 - Switching the A/C function on or off 104
 - Switching the rear window heater on/off 106
 - Switching the windscreen heater on/off 106
 - TEMPMATIC control panel 102
 - THERMOTRONIC control panel 103
 - Ventilating the vehicle (convenience opening) 59
 - Ventilation nozzles at front 106
 - Ventilation nozzles in the roof 107
 - Ventilation nozzles, rear 107
 - Co-driver bench seat**
 - Stowage box 79
 - Cockpit (overview)** 6
 - Combination switch**
 - see Headlamp flasher
 - see High beam
 - see Indicator
 - Compass** 243
 - Computer**
 - see On-board computer
 - Connection status**
 - Displaying 260
 - Overview 260
 - Contacts** 250
 - Calling up 251
 - Deleting 252
 - Deleting favourites 252
 - Downloading (from mobile phone) ... 250
 - Importing 251
 - Importing (overview) 251
 - Information 250
 - Making a call 251
 - Name format 251
 - Options 252
 - Saving as a favourite 252
 - Selecting options for suggestions 252
 - Storing 251
 - Convenience closing** 60
 - Convenience opening** 59
 - Convenience opening/closing via the air recirculation button** 106
 - Conversions** 23
 - Coolant (engine)**
 - Checking level 282
 - Notes 355
 - Copyright** 30
 - Cornering light** 88
 - Crosswind Assist**
 - Function/notes 154
 - Cruise control** 157
 - Buttons 158
 - Calling up a speed 158
 - Function 157
 - Requirements 158
 - Selecting 158
 - Setting a speed 158
 - Storing a speed 158
 - Switching off 158
 - Switching on 158
 - System limitations 157
- D
- Dashboard**
 - see Cockpit (overview)
 - Dashboard lighting**
 - see Instrument lighting
 - Data import/export** 217
 - Function/notes 217
 - Importing/exporting 217
 - Data recording (vehicle)** 28
 - Date**
 - Setting the time and date automatically 214
 - Dealership**
 - see Qualified specialist workshop
 - Declaration of conformity**
 - Electromagnetic compatibility 25
 - Jack 26
 - Wireless vehicle components 25
 - Destination** 235
 - Editing intermediate destinations 229
 - Editing the previous destinations 236
 - Quick-access to destination information 233
 - Saving (current vehicle position) 235
 - Destination entry** 221
 - Entering 3 word addresses 225
 - Entering a POI or address 221
 - Entering an intermediate destination 229
 - Entering geo-coordinates 225
 - Notes 221
 - Selecting a contact 224
 - Selecting a POI 223
 - Selecting from global favourites 225
 - Selecting from the map 225
 - Selecting previous destinations 223

- Detecting inattentiveness**
see ATTENTION ASSIST
- Diagnostics connection** 27
- Dial telephone number (on-board computer)** 186
- Diesel**
Low outside temperatures 350
Notes 350
- Diesel particulate filter**
Automatic regeneration 125
Cancelling regeneration 126
Notes 125
Starting regeneration 126
- Digital Owner's Manual** 21
- Digital speedometer** 184
- Dimming the inside mirror** 100
- Dipped beam**
Changing bulbs 92
Setting for abroad (symmetrical) 86
switching on/off 86
- Dipped beam**
see Automatic dipped beam
- DIRECT SELECT lever** 128
Engaging drive position 130
Engaging neutral 129
Engaging park position automatically 129
Engaging reverse gear 129
Function 128
Selecting park position 129
- Direction indicator**
see Indicator
- Display (care)** 289
- Display (multimedia system)** 203
Home screen 202
Notes 201
Operating 203
Settings 213
- Display (on-board computer)** 182
- Display message** 360
calling up (on-board computer) 360
Notes 360
- Display messages**
 369
 --- km/h 366
 12 V battery See Owner's Manual 371
- Active Brake Assist Functions currently limited See Owner's Manual ... 363
- Active Brake Assist Functions limited See Owner's Manual 363
- Active Distance Assist available again 367
- Active Distance Assist currently unavailable See Owner's Manual 366
- Active Distance Assist inoperative ... 366
- Active Lane Keeping Assist Camera view restricted See Owner's Manual 368
- Active Lane Keeping Assist currently unavailable See Owner's Manual 369
- Active Lane Keeping Assist inoperative 369
- Adaptive Highbeam Assist Camera view restricted See Owner's Manual 381
- Adaptive Highbeam Assist currently unavailable See Owner's Manual 381
- Adaptive Highbeam Assist inoperative 381
-  AdBlue system fault Engine start not possible 374
-  AdBlue system fault Perf. reduced in XXX miles See Owner's Manual 374
-  AdBlue system fault Perf. reduced: 12 mph No start in XXX miles 374
-  AdBlue system fault Performance reduced after eng. restart: XXX mph 375
-  AdBlue system fault Performance reduced: 12 mph 375
-  AdBlue system fault Performance reduced 375
-  AdBlue system fault See Owner's Manual 373, 375

-  Add 1 litre engine oil when next refuelling 370
- Air conditioning Malfunction See Owner's Manual 379
- Apply brake to deselect Park (P) position 380
- Apply brake to select R 379
-  ATTENTION ASSIST inoperative 369
-  ATTENTION ASSIST: Take a break! 369
-  AUTO lights inoperative 381
- Auxiliary battery malfunction 379
-  Before starting the engine, turn the steering wheel. 378
- Blind Spot Assist currently unavailable See Owner's Manual 368
- Blind Spot Assist inoperative 368
- Blind Spot Assist Trailer not monitored 368
- Cannot measure fluid level 374
-  Change key batteries 377
-  Check brake fluid level 362
- Check brake pads See Owner's Manual 362
-  Check eng. oil lev. when next refuelling 371
-  Check tyre(s) 376
-  Clean the fuel filter 369
-  Coolant Stop vehicle Switch engine off 371
- Cruise control and Limiter inoperative 366
- Cruise control inoperative 366
-  Currently unavailable Camera dirty 367
- Currently unavailable Radar sensors dirty 367
-  currently unavailable See Owner's Manual 365
-  currently unavailable See Owner's Manual 364
- LIM** 366
-  Engine oil level cannot be measured 370
-  Engine oil level Reduce oil level 370
-  Engine oil level Stop vehicle Switch engine off 370
-  Engine oil pressure Stop Switch off engine 370
-  Front left malfunction Consult workshop (example) 360
-  Incline too steep See Owner's Manual 361
-  inoperative Battery low 378
-  inoperative Refuel vehicle 378
-  inoperative See Owner's Man. 378
-  inoperative See Owner's Manual 365
-  inoperative See Owner's Manual 364
- EBD** inoperative See Owner's Manual 364
-  Key not detected (red display message) 377
-  Key not detected (white display message) 377
-  Left dipped beam (example) 382
-  Left windowbag malfunction Consult workshop (example) 360
- Limiter inoperative 366
- Limiter passive 366
-  Malfunction See Owner's Manual 381
-  Maximum speed exceeded 366
- N permanently active Risk of vehicle rolling 380
-  Off 366
- HOLD** Off 367
- Only select Park (P) when vehicle is stationary 380
-  Parking brake inoperative 361
-  Parking brake See Owner's Manual 362

-  Place the key in the marked space See Owner's Manual 377
- Radar sensors dirty See Owner's Manual 363
-  Rectify tyre pressure 376
-  Refill AdBlue No start in XXX miles 373
-  Refill AdBlue See Owner's Manual 373, 374
-  Refill AdBlue Start not possible 373
- Regeneration not possible 372
-  Replace air cleaner 369
-  Replace key 377
-  Reserve fuel level 369
-  Restraint sys. malfunction Consult workshop 361
- Reversing not poss. Consult workshop 379
- Risk of vehicle rolling Driver door open and transmission not in P 380
-  See Owner's Manual 371
- SOS NOT READY 363
- Speed limit (winter tyres) XXX km/h 366
-  Steering malfunction Increased physical effort See Owner's Manual 378
-  Steering malfunction Stop immediately See Owner's Manual 379
- Step not extended See Owner's Manual or step not extended malfunction 380
-  Stop vehicle Leave engine running 371
-  Stop vehicle See Owner's Manual 371
-  Switch off lights 381
-  Switch on headlamps 381
-  System fault No start in XXX miles 373
- To shift out of P or N, depress brake and start engine 380
- To start engine, shift to either P or N 379
-  Top up AdBlue Perf. reduced in XXX miles See Owner's Manual 373
-  Top up AdBlue Perf. reduced: 12 mph No start in XXX miles 373
-  Top up AdBlue Performance reduced after eng. restart: 12 mph ... 374
-  Top up AdBlue Performance reduced 374
-  Top up AdBlue Power reduced: 12 mph 375
-  Top up coolant See Owner's Manual 372
-  Top up washer fluid 377
- Traffic Sign Assist Camera view restricted See Owner's Manual 367
- Traffic Sign Assist currently unavailable See Owner's Manual 368
- Traffic Sign Assist inoperative 367
- Transmission Malfunction Stop 379
- Tyre press. monitor currently unavailable 375
- Tyre pressure monitor inoperative ... 376
- Tyre pressure monitor inoperative No wheel sensors 375
-  Vehicle is operational Switch off the ignition before exiting 379
- Vehicle locating has been activated. Details: see manual or associated mobile app. or vehicle locating activated – see manual or mobile app. 380
-  Warning tyre defect 376
-  Wheel sens. missing 375
- Without changing gear, consult workshop 380
- Display range (trip menu) 184**
- Display total distance (trip menu) 184**
- Distance adjustment**
see Active Distance Assist DISTRONIC
- Distance control**
see Active Distance Assist DISTRONIC

- Distance recorder**
see Trip distance
- DISTRONIC**
see Active Distance Assist DISTRONIC
- Door**
Additional door lock 47
Locking (emergency key element) 49
Unlocking (emergency key element) ... 49
- Door control panel** 17
- Drinking and driving** 116
- Drive Away Assist** 171
- Driver's seat**
see Seats
- Driving characteristics (unusual)** 311
- Driving instructions**
Foreign trip (information) 118
- Driving notes**
Transport by rail 118
- Driving Safety System**
ABS (Anti-lock Braking System) 152
Adaptive brake lights 157
ASR (acceleration skid control) 153
BAS (Brake Assist System) 153
EBD (Electronic Brakeforce Distribution) 154
ESP® Crosswind Assist 154
ESP® trailer stabilisation 154
Overview 152
Radar sensors 152
Responsibility 152
- Driving safety system**
see Active Brake Assist
see ESP® (Electronic Stability Program)
- Driving system**
see 360° Camera
see Active Distance Assist DISTRONIC
see Active Lane Keeping Assist
see ATTENTION ASSIST
see Blind Spot Assist
see Cruise control
see HOLD function
see Lane Keeping Assist
see Limiter
see Parking Assist PARKTRONIC
see Reversing camera
see Traffic Sign Assist
- Driving tips**
Aquaplaning 120
Brake subject to load 119
Braking 119
Downhill gradient 119
Drinking and driving 116
Driving abroad (symmetrical dipped beam) 86
Driving in winter 120
Driving off-road 121
Driving on flooded roads 120
Driving on wet roads 120
General driving tips 116
Mountainous terrain 124
New brake discs and brake pads/linings 119
Parking brake 119
Running-in notes 116
Wet road surfaces 119
- Drowsiness detection**
see ATTENTION ASSIST
- DSR (Downhill Speed Regulation)**
Activating/deactivating 134
Notes 134
- E**
- EBD (Electronic Brakeforce Distribution)** 154
- ECO display**
Function 124
Resetting 185
- ECO start/stop function** 124
Automatic engine start 124
Automatic engine stop 124
Operation 124
Switching on/off 124
- Electric parking brake** 148
Applying automatically 148
Applying or releasing manually 150
Emergency braking 150
Notes 148
Releasing automatically 149
- Electric sliding door**
Function 51
Opening with the door handle 52
Opening/closing with the key 52
Programming the key 52
Resetting 53
Unlocking manually 53
- Electrical closing assist**
Notes 51
- Electrical consumption**
Key 46
- Electrical fuses**
see Fuses
- Electrical sliding door**
Opening with button 51

- Electrical step**
 - emergency release 56
 - Function 55
 - Obstacle 55
 - Prevent extending 55
 - retract/extend 55
 - Electromagnetic compatibility (de-
claration of conformity)** 25
 - Electronic Stability Program**
see ESP® (Electronic Stability Program)
 - Electronics** 347
 - Emergency**
 - Fire extinguisher 291
 - First-aid kit (soft-sided) 291
 - Overview of help 19
 - Removing the warning triangle 291
 - Safety vest 291
 - Setting up the warning triangle 291
 - Warning lamp 291
 - Emergency braking**
 - Electric parking brake 150
 - Manual parking brake 148
 - Emergency call system**
see Mercedes-Benz emergency call system
 - Emergency engine start** 307
 - Emergency key element**
 - Locking door 49
 - Removing/inserting 46
 - Unlocking door 49
 - Emergency operation mode**
 - Starting the vehicle 115
 - Engaging drive position (automatic
transmission)** 130
 - Engaging neutral (automatic trans-
mission)** 129
 - Engaging reverse gear** 129
 - Engaging/disengaging LOW RANGE** ... 133
 - Engine**
 - ECO start/stop function 124
 - Engine number 348
 - Jump-starting 296
 - Parking (start/stop button) 146
 - Problems 141
 - Starting (in emergency operation
mode) 115
 - Starting (start/stop button) 115
 - Engine data**
 - Indicators 219
 - Engine electronics (notes)** 347
 - Engine number** 348
 - Engine oil** 281
 - Additive 353
 - Checking the oil level (on-board
computer) 280
 - Filling capacity 353
 - Topping up 281
 - Engine output**
 - Notes on changes 27
 - ENR (electronic level control)** 135
 - Function 135
 - Lowering the vehicle 137
 - Manually inflating air bellows 138
 - Problems 138
 - Raising the vehicle 137
 - Entering characters**
 - Function/notes 211
 - Setting the keyboard 213
 - Using the media display 211
 - Environmental protection**
 - Notes 22
 - Take-back of end-of-life vehicles 22
 - ERA-GLONASS test mode**
 - Starting/ending 294
 - ESC (Electronic Stability Control)**
see ESP® (Electronic Stability Program)
 - ESP®**
 - Crosswind Assist 154
 - Trailer stabilisation 154
 - ESP® (Electronic Stability Program)** ... 153
 - Activating/deactivating 154
 - Function/notes 153
 - Exterior lighting**
 - Care 287
 - Rotating beacon 89
 - Exterior lighting**
see Lights
- F
- Fatigue detection**
see ATTENTION ASSIST
 - Fault message**
see Display message
 - Favourites**
 - Adding 208
 - Calling up 208
 - Deleting 208
 - Moving 208
 - Overview 208
 - Renaming 208

- Filling station search**
 Starting automatic search 230
 Switching automatic search on/off
 230
- Filling up the windscreen washing system** 283
- Fire extinguisher** 291
- First-aid kit (soft-sided)** 291
- Flat tyre** 294
 Changing a wheel 335
 Notes 294
- Floor covering**
 Fitting/removing (starter battery) 298
- Floor mats** 85
- Foreign trip**
 Instructions 118
 symmetrical dipped beam 86
- Free software** 30
- Frequencies**
 Mobile phone 347
 Two-way radio 347
- Front airbag (driver, front passenger)** .. 35
- Front door**
 Opening (from inside) 48
 Unlocking (from inside) 48
- Front passenger bench seat**
 Folding the seat cushion forwards/
 backwards 71
- Front seats**
 8-way adjustment options 67
 adjusting (electrically) 67
 Adjusting (manually) 64, 66
 Memory function 67
 rotate 70
 With Seat Comfort Package 66
 Without Seat Comfort Package 64
- Fuel**
 Diesel 350
 Draining the filter 284
 Fuel reserve 351
 Low outside temperatures 350
 Problems 141
 Quality (diesel) 350
 Refuelling 139
 Tank capacity 351
- Fuel consumption (on-board computer)** 184
- Fuel consumption indicator**
 Calling up 219
- Fuses** 308, 309
 Before replacing 308
 Fuse box in the co-driver's footwell
 309
 Fuse box in the seat base of the
 driver's seat 308
 Notes 308
- G**
- Gearshift lever** 127
- Gearshift recommendation** 128
- General operating permit number (EU)** 348
- Glasses compartment** 79
- Global search**
 Function 210
 Overview 210
- Gross mass** 348
- H**
- Handbrake (electrical)**
 see Electric parking brake
- Handbrake (manual)**
 see Manual parking brake
- Handling control system**
 see ESP® (Electronic Stability Program)
- Hazard warning lights** 88
 Switching on/off 88
- Head restraint**
 Adjusting mechanically 75
- Headlamp flasher** 87
- Heating system (control panel)** 101
- High beam** 87
 Activating/deactivating 87
 Changing bulbs 92
- High-pressure cleaner (care)** 286
- Highbeam**
 Adaptive Highbeam Assist 88
- Hill start assist** 162
- HOLD function** 162
- Home screen (media display)** 202
- Hot-water auxiliary heater** 108
 Displays (remote control) 110
 Function 108
 Problems 111
 switching on/off by remote control
 109
 switching on/off with the button 108

- Switching on/off with the on-board computer 110
- Hotspot**
Setting up (Wi-Fi) 216
- I**
- Identification plate**
Engine 348
Refrigerant 356
Vehicle 348
- Ignition key**
see Key
- Immobiliser** 61
- Implied warranty (vehicle)** 28
- Indicator** 87
Activating/deactivating 87
Changing bulbs (front) 92
Changing bulbs (rear) (chassis) 95
Changing bulbs (rear) (panel van and crewbus) 94
- Installations** 23
- Instrument display**
Function/notes 180
Overview 8, 180
Setting the lighting 183
- Instrument display**
see Warning/indicator lamp
- Instrument lighting** 183
- Intelligent light system**
Adaptive Highbeam Assist 88
Cornering light 88
- Interior lamps (rear) (replacing the light bulbs)** 96
- Interior lighting**
Load compartment 91
Rear 91
Setting 90
Switch-off delay time 92
- Interior motion sensor**
Function 62
Priming/deactivating 62
- Interior roof carrier system** 274
- Intermediate destination**
Calculating a route with intermediate destinations 229
Entering 229
Modifying 229
Starting an automatic filling station search 230
- Starting the automatic service station search 230
- Internet**
Calling up a web page 260
Closing the browser 262
Deleting a bookmark 261
Deleting history 261
Managing bookmarks 261
- Internet connection**
Automatic disconnection 259
Cancelling permission (mobile phone) 259
Communication module function 258
Connection status 260
Disconnection following Inactivity 259
Displaying the connection status 260
Establishing 259
Establishing automatically 259
Information 257
Mobile phone details 259
Restrictions 257
Setting access data (Bluetooth®) 259
Setting up (Bluetooth®) 259
Setting up (Wi-Fi) 258
- Internet radio**
Calling up 262
Calling up the station list (category last selected) 263
Deleting stations 263
Logging out 263
Overview 262
Registering 263
Saving stations 263
Selecting and connecting to a station 263
Selecting stream 263
Setting options 263
Terms of use 263
- iPhone®**
see Apple CarPlay™
- ISOFIX child seat securing system**
Fitting 38
Notes 38
- J**
- Jack** 334
Declaration of conformity 26
Hydraulic 310
Removing the hydraulic jack from the stowage compartment 310
Storage location of hydraulic jack 310
- Jump-start connection** 296

- Jump-starting**
see Jump-start connection
- K**
- Key** 45
Acoustic locking verification signal 46
Battery 46
Emergency key element 46
Energy consumption 46
Functions 45
Key ring attachment 46
Overview 45
Problem 47
Radio connection 45
Unlocking setting 46
- L**
- Ladder rack**
Maximum load 359
Overview 274
Platform truck 274
technical data 359
- Lane detection (automatic)**
see Active Lane Keeping Assist
- Lane Keeping Assist** 172
Function 172
System limitations 172
Trailer operation 172
- Lane Keeping Assist**
see Active Lane Keeping Assist
see Lane Keeping Assist
- Language** 216
Notes 216
Setting 217
- Lashing points** 272
Information 357
- Level control**
see ENR (electronic level control)
- Licence plate lighting (changing bulbs)** 95
- Light switch (overview)** 86
- Lighting**
see Lights
- Lights** 86
Adaptive Highbeam Assist 88
Automatic dipped beam 86
Combination switch 87
Cornering light 88
Dipped beam 86
Driving abroad (symmetrical dipped beam) 86
Hazard warning lamps 88
Headlamp flasher 87
High beam 87
Indicator 87
Light switch 86
Parking light 86
Range 87
Rear fog light 87
Responsibility with lighting systems ... 86
Setting the exterior lighting switch-off delay time 89
Setting the instrument lighting 183
Standing light 86
Switching the surround lighting on/off 89
- Limiter** 157
Buttons 158
Calling up a speed 158
Function 157
Passive 157
Permanent setting 159
Requirements: 158
Selecting 158
Setting a speed 158
Storing a speed 158
Switching off 158
Switching on 158
System limitations 157
- Limiting speed** 118
- LINGUATRONIC** 188
Application specific voice commands 189
Audible help functions 190
Entering numbers 189
Global voice commands 189
Improving speech quality 190
Language setting 189
Media player voice commands 195
Message voice commands 197
Multifunction steering wheel (operating) 188
Navigation voice commands 191
Notes on the voice commands 191
Online voice control 190
Operable functions 189
Operating safety 188
Radio voice commands 194
Setting (multimedia system) 189
Switch voice commands 191
Telephone voice controls 193
Text message voice commands 197
Types of voice commands 189
Vehicle voice commands 197
Voice prompting 188

Live Traffic Information

Displaying subscription information	237
Displaying the traffic map	237
Displaying traffic incidents	238
Information on subscription extension	237
Registering on Mercedes PRO	237
Showing local area messages	238
Switching the traffic information display on	238

Load distribution	271
--------------------------------	-----

Load securing

Fitting and removing tie-down eyes ..	273
Lashing points	272
Notes	271

Loading guidelines	77, 270
---------------------------------	---------

LOW range	133
------------------------	-----

Lubricant additives

see Additive

Lumbar support (4-way)	69
-------------------------------------	----

M

M+S tyres	311
------------------------	-----

Maintenance

see ASSYST PLUS

Malfunction

Restraint system	31
------------------------	----

Manual parking brake	147
-----------------------------------	-----

Applying/releasing	147
Emergency braking	148
Folding up/down	147

Manual transmission

Engaging reverse gear	127
Using the gearshift lever	127

Manually inflating air bellows (ENR) ...	138
---	-----

Map	237, 240
------------------	----------

Avoiding an area	242
Avoiding an area (overview)	242
Changing an area	242
Deleting an area	242
Displaying Qibla	243
Displaying the compass	243
Displaying the map version	242
Displaying the next intersecting street	241
Displaying the satellite map	244
Displaying the traffic map	237
Displaying weather information	244
Map data	243
Moving	240

Selecting POI symbols	240
Selecting text information	241
Selecting the map orientation	240
Setting the map scale	240
Setting the map scale automatically	243
Switching motorway information on/off	241
Updating	242

Matt finish (cleaning instructions)	287
--	-----

Maximum speed

see Limiter

MBUX multimedia system (overview)

.....	201
-------	-----

Mecca	243
--------------------	-----

Media

Menu (on-board computer)	186
Operating media playback	186
Selecting a media source	186

Media display

Entering characters	211
Home screen	202
Notes	201

Media mode

Adding a favourite song	266
Connecting Bluetooth® audio equipment	265
Connecting USB devices	265
Controlling media playback	266
Copyright and trademarks	263
Notes about the search function in categories	266
Overview of the media menu	265
Playing back similar music tracks	266
Removing a favourite song	266
Searching for a music track according to mood	267
Starting a search in categories	267
Starting media playback	266
Supported format and data storage media	263
Surprise mix	266
Using the keyword search	267

Memory function (seat)	69
-------------------------------------	----

Menu (on-board computer)

Assistance graphic	183
Media	186
Navigation	185
Overview	181
Radio	186
Service	183
Settings	187

- Telephone 186
- Trip 184
- Mercedes PRO**
- Information 199
- Mercedes PRO connect**
- Accident management 200
- Breakdown assistance call via the
breakdown assistance button 200
- Calling the Customer Centre 199
- Consenting to data transfer 200
- Information 199
- Making a call via the overhead control
panel 199
- Transferred data 200
- Mercedes-Benz emergency call system**
- Automatic emergency call 293
- Information 292
- Information on data processing 293
- Manual emergency call 293
- Overview 292
- Self-diagnosis (Russia) 294
- Starting/ending ERA-GLONASS
test mode 294
- Mercedes-Benz service centre**
- see Qualified specialist workshop
- Message (multifunction display)**
- see Display message
- Message memory** 360
- Messages** 253
- Calling a message sender 254
- Composing 254
- Configuring the displayed text
messages 253
- Deleting 254
- Forwarding 254
- Overview 253
- Reading 253
- Replying 254
- Sending 254
- Using a number/URL 254
- Using templates 254
- Voice commands (LINGUATRONIC) .. 197
- Mirrors**
- Adjusting the inside mirror 100
- Mirrors**
- see Outside mirrors
- Mobile phone** 347
- Cancelling permission for Internet
connection 259
- Frequencies 347
- Transmission output (maximum) 347
- Wireless charging 84
- Mobile phone**
- see Android Auto
- see Apple CarPlay™
- see Mobile phone
- see Telephone
- Mobile phone voice recognition**
- Starting 249
- Stopping 249
- Model series** 348
- Mounting a load** 77, 270
- Multifunction display (on-board
computer)** 182
- Multifunction steering wheel**
- Button overview 181
- Multifunction steering wheel**
- see Steering wheel
- Multimedia system**
- Adjusting the volume 205
- Configuring display settings 213
- Entering characters 211
- Main functions 204
- Restoring the factory settings 219
- Switching the sound on/off 205
- Multimedia system**
- see Display (multimedia system)
- see MBUX multimedia system (overview)
- see Touch Control

N

- Navigation**
- Menu (on-board computer) 185
- Overview 220
- Showing/hiding the menu 220
- Switching on 220
- Updating the map data 242
- Voice commands (LINGUATRONIC) ... 191
- Navigation**
- see Destination
- see Destination entry
- see Route
- see Route guidance
- see Traffic information
- Navigation announcements**
- Activating/deactivating 234
- Adjusting the volume 234
- Repeating 235
- Switching audio fadeout on/off 234
- Navigation instructions (on-board
computer)** 185

- Near Field Communication (NFC)** 248
 Connecting the mobile phone to
 the multimedia system 248
 General information 248
 Switching mobile phones 248
 Using a mobile phone 248
- NFC**
 see Near Field Communication (NFC)
- Notification types** 209
- Notifications Centre**
 Calling up notifications 209
 Editing notifications 210
 Global search 210
 Notification types 209
 Overview 209
 Selecting actions for notifications 209
 Using the global search 210
- Notifications Centre**
 see Notification types
- Nozzles**
 see Air vents
- O**
- Occupant safety**
 Pets in the vehicle 44
- Occupant safety**
 see Airbag
 see Restraint system
 see Seat belt
- Oil**
 see Engine oil
- On-board computer** 181
 Adjusting the stationary heater/
 ventilation 110
 Assistance graphic menu 183
 Displaying the service due date 278
 Media menu 186
 Menu navigation 185
 Menus overview 181
 Multifunction display 182
 Operating 181
 Radio menu 186
 Service menu 183
 Settings menu 187
 Telephone menu 186
 Trip menu 184
- On-board diagnostics interface**
 see Diagnostics connection
- On-board electronics**
 Engine electronics 347
 Notes 347
 Two-way radios 347
- Open-source software** 30
- Opening and closing the lockable
 compartment above the windscreen** ... 78
- Opening the cup holder in the rear** 80
- Opening/closing the bonnet** 278
- Operating fluids**
 AdBlue® 352
 Brake fluid 355
 Coolant (engine) 355
 Engine oil 353
 Fuel (diesel) 350
 Notes 349
 Windscreen washer fluid 356
- Operating safety**
 Changes in the engine power out-
 put 27
 Declaration of conformity (electro-
 magnetic compatibility) 25
 Declaration of conformity (Jack) 26
 Declaration of conformity (wireless
 vehicle components) 25
 Information 24
- Operating sun visor** 100
- Operating system**
 On-board computer 181
- Original parts** 22
- Outside mirrors** 99
 folding in/out 99
 Setting 99
 Setting options 17
- Overhead control panel**
 Adjusting the interior lighting 90
 Overview 13
- Owner's Manual (digital)** 21
- Owner's Manual (vehicle equipment)** ... 24
- P**
- Paint (cleaning instructions)** 287
- Paint code** 348
- Park pawl**
 Deactivating manually 131
- Park position**
 Engaging 129
 Engaging automatically 129
- Parking (navigation service)**
 Showing a parking option on the
 map 245
- Parking (service for navigation)**
 Notes 244

Selecting parking options	244
Parking aid	
see Parking Assist PARKTRONIC	
Parking Assist PARKTRONIC	162
Activating	163
Adjusting warning tones	163
Deactivating	163
Drive Away Assist	171
Function	162
System limitations	162
Parking brake (electrical)	
see Electric parking brake	
Parking brake (manual)	
see Manual parking brake	
Parking light	86
Parking up	150
Partition sliding door	
from the driver's compartment	55
from the load compartment	55
Permissible axle load	348
Permissible gross mass	348
Permissible towing methods	303
Pets in the vehicle	44
Phone book	
see Contacts	
PIN protection	
Switching on/off	217
Placing a load on the wheel arch	277
Plastic trim (care)	289
Platform dropsides	
attaching/detaching	58
Fitting/removing	57
Opening or closing	57
Side walls	58
POI	
Quick access	233
Selecting	223
POI symbols	
Selecting	240
Power supply	
Battery main switch	127
Switching on (start/stop button)	114
Power take-off	
Switching on and off	174
Power windows	
see Side window	
Previous destinations	
Selecting	223

Profile

Calling up suggestions	207
Configuring suggestions	207
Creating a new profile	206
Deleting suggestions	207
Maximum number of profiles	205
Overview	205
Renaming suggestions	207
Selecting a profile	206
Selecting profile options	206
Showing the profile selection when starting the vehicle	206
Suggestions (overview)	206

Profile

 see User profile

Q

Qibla	243
QR code (rescue card)	28
Qualified specialist workshop	27

R

Rack systems (information)	273
Radar sensors	152

Radio

Activating/deactivating radio text	269
Calling up the station list	268
Deleting channels	269
Direct frequency entry	268
Displaying information	269
Displaying radio text	269
Editing station presets	269
Frequency fix	269
Menu (on-board computer)	186
Moving stations	269
Overview	268
Searching for stations	268
Setting a channel	268
Setting station tracking	269
Setting the frequency band	268
Setting the traffic information service volume increase	269
Storing radio stations	268
Switching on	267
Switching traffic announcements on/off	269
Voice commands (LINGUATRONIC) ..	194

Radio connection

Key	45
-----------	----

REACH regulation	28
-------------------------------	----

Real wood (care)	289
-------------------------------	-----

- Rear**
 - Motion detector 91
- Rear bench seat**
 - see Seats
- Rear compartment heating** 104
- Rear Cross Traffic Alert** 172
- Rear doors**
 - Opening and closing (from inside) 54
 - Opening and closing (from outside) 54
- Rear fog light** 87
- Rear window wiper**
 - Replacing 99
 - switching on/off 97
- Recycling**
 - see Take-back of end-of-life vehicles (environmental protection)
- Reducing agent**
 - see AdBlue®
- Refrigerant (air conditioning)**
 - Notes 356
- Refuelling**
 - AdBlue® Displaying the fill level 142
 - Displaying the AdBlue® range 142
 - Refuelling the vehicle 139
 - Topping up AdBlue® 142
- Regeneration**
 - Cancelling 126
 - Notes 125
 - Starting 126
- Registration**
 - Vehicle 28
- Regulating headlamp range** 87
- Remote control (stationary heating/ventilation)**
 - Changing the battery 110
 - Displays 110
 - Setting 109
- Removing the vehicle tool kit** 309
- Replacing a wheel**
 - Fitting a new wheel 339
- Rescue card** 28
- Reset function (multimedia system)** ... 219
- Restoring (factory settings)**
 - see Reset function (multimedia system)
- Restraint system** 31
 - Children, notes on safe transportation 36
 - Function in an accident 32
 - Functionality 31
 - Malfunction 31
 - Protection 31
 - Reduced protection 31
 - Self-test 31
 - Warning lamp 31
- Restricting the shift range** 130
- Reversing camera** 163
 - Care 287
 - Function 163
 - Switching automatic operation on/off (360° Camera) 167
- Reversing light**
 - Changing bulbs 95
 - Replacing light bulbs (panel vans and crewbuses) 94
- Rims (care)** 287
- Roll away protection**
 - see HOLD function
- Roof carrier (inside)** 274
- Roof lining (care)** 289
- Roof rack** 358
- Roof rack (information)** 273
- Route** 226, 230
 - Accepting a detour recommendation after a prompt 239
 - Activating a commuter route 230
 - Alternative route (quick-access) 233
 - Calculating 226
 - Displaying destination information ... 228
 - Displaying the route list 229
 - Editing a stored route 231
 - Planning 229
 - Recording a route 231
 - Saving a recorded route 231
 - Selecting a type 227
 - Selecting an alternative route 230
 - Selecting notifications 228
 - Selecting options 227
 - Showing a stored route on the map 231
 - Starting a saved route 231
 - Starting the automatic service station search 230
 - Switching the automatic filling station search on/off 230
 - With intermediate destinations 229
- Route guidance** 232
 - Cancelling 235
 - Changing direction 232
 - Destination reached 234

- From an off-road location 235
 - Lane recommendations 233
 - Motorway information 233
 - Notes 232
 - Off-road 235
 - To an off-road destination 235
 - Running-in notes** 116
- S**
- Safety vest** 291
 - Seat belt** 32, 34
 - Adjusting the height 34
 - Care 289
 - Fastening 34
 - Protection 32
 - Reduced protection 33
 - Releasing 34
 - Warning lamp 34
 - Seat belt tensioners**
 - Activation 32
 - Seat belt warning**
 - see Seat belt
 - Seat cover (care)** 289
 - Seats** 64, 72
 - 4-way lumbar support 69
 - 8-way adjustment options 67
 - Adjusting armrests 71
 - Adjusting the armrests (rear bench seat) 74
 - Adjusting the head restraints mechanically 75
 - Adjusting the seat cushion (twin co-driver's seat) 71
 - correct driver's seat position 64
 - Folding the folding seat up / down 71
 - front (adjust electrically) 67
 - Front (adjusting manually, with Seat Comfort Package) 66
 - Front (adjusting mechanically, without Seat Comfort Package) 64
 - Front (adjusting mechanically) 66
 - Installing and removing rear bench seat 72
 - Memory function 67
 - Operating the memory function 69
 - rotate (front seat) 70
 - Setting options 17
 - With Seat Comfort Package 66
 - Without Seat Comfort Package 64
 - Securing luggage** 77, 270
 - Selector lever**
 - see DIRECT SELECT lever
 - Sensors (care)** 287
 - Service**
 - see ASSYST PLUS
 - Service (on-board computer)** 183
 - Service centre**
 - see Qualified specialist workshop
 - Service interval display**
 - see ASSYST PLUS
 - Service products**
 - Refrigerant (air conditioning) 356
 - Service station search**
 - Starting automatic search 230
 - Setting a speed limit**
 - see Limiter
 - Setting the date format** 214
 - Setting the distance unit** 217
 - Setting the map scale**
 - see Map
 - Setting the speed**
 - see Cruise control
 - Settings (on-board computer)** 187
 - Shifting gears**
 - Gearshift recommendation 128
 - Short messages**
 - see Messages
 - Short-distance trips** 118
 - Side impact airbag** 35
 - Side marker lamps (replacing the light bulbs)** 96
 - Side window** 58
 - Closing 58
 - Closing (all) 58
 - Closing using the key 60
 - Convenience closing 60
 - Convenience opening 59
 - Opening 58
 - Opening (all) 58
 - Opening with the key 59
 - Side windows**
 - Adjusting 60
 - Problem 60
 - Sliding door**
 - B-pillar door sill (button) 51
 - Centre console (button) 51
 - Child safety lock 43
 - Closing (from inside) 50
 - Closing (from outside) 50
 - Opening (from inside) 50
 - Opening (from outside) 50

- Smartphone**
 - see Android Auto
 - see Apple CarPlay™
 - see Telephone
- Snow chains** 312
- Socket (12 V)** 81
 - Driver's seat 82
 - Front centre console 81
 - Load compartment 83
- Socket (230 V) (centre console, front)** 82
- Software update** 218
 - Important system updates 218
 - Information 218
 - Performing 218
- Sound**
 - see Tone settings
- Sound settings**
 - Adjusting the balance/fader 269
 - Adjusting treble, mid-range and bass settings 269
 - Automatic volume adjustment 269
- Spare wheel**
 - Fitting/removing 342
 - Notes 341
- Specialist workshop** 27
- Speech dialogue system**
 - see LINGUATRONIC
- Speed limitation for winter tyres**
 - Setting 159
- Speedometer (digital)** 184
- Standby mode**
 - Activating/deactivating 151
- Standing light** 86
- Start/stop button**
 - Parking the vehicle 146
 - Starting the vehicle 115
 - Switching on the power supply or the ignition 114
- Starting**
 - see Vehicle
- Starting-off aid**
 - see Hill start assist
- Station**
 - Deleting 269
 - Direct frequency entry 268
 - Frequency fix 269
 - Moving 269
 - Searching 268
 - Setting 268
 - Storing 268
- Station list**
 - Calling up 268
- Station presets**
 - Modifying 269
- Station tracking**
 - Setting 269
- Stationary heating**
 - Problems 111
- Stationary heating**
 - see Auxiliary warm-air heater
- Stationary heating/ventilation**
 - Adjusting (on-board computer) 110
 - Displays (remote control) 110
 - Setting (remote control) 109
- Stationary heating/ventilation**
 - see Auxiliary heating
 - see Hot-water auxiliary heater
- Steering wheel** 181
 - Adjusting 76
 - Buttons 181
- Stop/start function**
 - see ECO start/stop function
- Stopping the alarm (ATA)** 61
- Stowage areas**
 - see Stowage space
- Stowage box** 79
- Stowage compartments**
 - see Stowage space
- Stowage space** 78
 - Armrest 78
 - Centre console 78
 - Cockpit 78
 - Door 78
 - Glasses compartment 79
 - Glove compartment 78
 - Stowage box 79
- Summer tyres** 311
- Surround lighting**
 - Switching on/off 89
- Surround View**
 - see 360° Camera
- SVHC (substances of very high concern)** 28
- Switch clock**
 - Activating 111
 - Overview 111
 - Setting 111
 - Setting the departure time 112

- Setting the temperature/operating duration 112
- Switching immediate heating mode on/off 112
- Switch-off delay time**
- Exterior 89
- Interior 92
- Switching on ignition (start/stop button)** 114
- Switching seat heating on/off** 75
- Switching the A/C function on or off** 104
- Switching the rear window heater on/off** 106
- Switching the windscreen heater on/off** 106
- System settings**
- Activating/deactivating PIN protection 217
- Reset function (multimedia system) 219
- Setting the distance unit 217
- Setting the time and date automatically 214
- Setting the time zone 214
- Setting the time/date format 214
- System settings**
- see Bluetooth®
- see Data import/export
- see Language
- see Software update
- see Wi-Fi
- T**
- Tailpipes (care)** 287
- Take-back of end-of-life vehicles (environmental protection)** 22
- Tank capacity**
- Fuel 351
- Reserve (fuel) 351
- Tank content**
- AdBlue® 352
- Technical data**
- Information 347
- Notes (trailer hitch) 357
- Tyre pressure monitor 329
- Vehicle identification plate 348
- Telephone** 186, 246
- Activating functions during a call 250
- Changing the function of a mobile phone 248
- Connecting a mobile phone (Near Field Communication (NFC)) 248
- Connecting a mobile phone (Passkey) 247
- Connecting a mobile phone (Secure Simple Pairing) 247
- Connecting a second mobile phone (Secure Simple Pairing) 247
- Disconnecting a mobile phone 248
- Importing contacts 251
- Importing contacts (overview) 251
- Incoming call during an existing call 250
- Information 247
- Interchanging mobile phones (two phone mode) 248
- Menu (on-board computer) 186
- Mobile phone voice recognition 249
- Notes 246
- Operating modes 246
- Reception and transmission volume 249
- Ringtone volume 249
- Switching mobile phones 248
- Switching mobile phones (Near Field Communication (NFC)) 248
- Telephone menu overview 246
- Telephone operation 249
- Two phone mode (function) 247
- Using Near Field Communication (NFC) 248
- Voice commands (LINGUATRONIC) .. 193
- Wireless charging (mobile phone) 84
- Telephone operation**
- see Calls
- Telephony operating modes**
- Bluetooth® Telephony 246
- Business telephony 246
- TEMPMATIC (control panel)** 102
- Text messages**
- Voice commands (LINGUATRONIC) .. 197
- Text messages**
- see Messages
- THERMOTRONIC (control panel)** 103
- Tie-down eyes** 273
- Time**
- Manual time setting 214
- Setting the time and date automatically 214
- Setting the time zone 214

- Setting the time/date format 214
- Tone settings** 269
 - Calling up the sound menu 269
 - Information 269
- Tongue weight (maximum)** 357
- Tool**
 - see Removing the vehicle tool kit
 - see Vehicle tool kit
 - see Vehicle tool kit stowage compartment
- Top Tether** 39
- Total distance recorder**
 - see Display total distance (trip menu)
- Touch Control** 203
 - On-board computer 181
 - Operating 203
 - Setting acoustic operating feed-back 203
 - Setting the sensitivity 203
- Touchscreen (media display)**
 - Operating 203
 - Setting acoustic operating feed-back 204
- Tow starting** 307
- Tow-away protection**
 - Function 61
 - Switching on/off 62
- Towing away** 304
 - Raised front or rear axle 306
- Towing eye**
 - Fitting/removing 307
 - Storage location 307
- Towing eye (storage location)**
 - see Vehicle tool kit
- Towing methods** 303
- Traffic announcements**
 - Activating/deactivating 269
- Traffic information** 236
 - Displaying the traffic map 237
 - Displaying traffic incidents 238
 - Live Traffic Information 237
 - Overview 236
 - Switching on the display 238
- Traffic information service volume increase**
 - Setting 269
- Traffic map**
 - see Map
- Traffic Sign Assist** 169
 - Function/notes 169
- Setting 170
- System limitations 169
- Trailer hitch**
 - Attaching the ball coupling 177
 - Care 287
 - General notes 357
 - Information about trailer operation ... 175
 - Removing the ball neck 178
 - Socket 178
- Trailer loads** 357
- Trailer operation**
 - Active Lane Keeping Assist 173
 - Attaching the ball coupling 177
 - Coupling/Decoupling the trailer 178
 - Lane Keeping Assist 172
 - Notes 175
 - Permissible axle load 348
 - Removing the ball neck 178
 - Socket 178
 - Tongue weight (maximum) 357
 - Trailer loads 357
- Trailer stabilisation** 154
- Transferred vehicle data**
 - Android Auto 257
 - Apple CarPlay™ 257
- Transmission position display** 128
- Transmission ratio**
 - LOW range 133
- Transmission ratio**
 - see Engaging/disengaging LOW RANGE
- Transport by rail** 118
- Transporting (vehicle breakdown)** 306
- Trim element (care)** 289
- Trip**
 - Display total distance 184
 - Menu (on-board computer) 184
- Trip computer**
 - Resetting 185
 - Showing 184
- Trip distance** 184
 - Resetting 185
 - Showing 184
- Trip meter**
 - see Trip distance
- Turn signal light**
 - Additional turn signal light (all-wheel drive vehicles) 93
- Twin co-driver's seat** 71

Two-way radio telephone	
see Mobile phone	
Two-way radios	
Frequencies	347
Installation notes	347
Transmission output (maximum)	347
Tyre pressure	
Checking (tyre pressure monitoring system)	328
Notes	313
Restarting the tyre pressure monitor	329
Tyre pressure monitoring system (function)	328
Tyre pressure table	314
Tyre pressure monitor	
Checking the tyre pressures	328
Checking the tyre temperature	328
Function	328
Restarting	329
Technical data	329
Tyre pressure table	314
Tyre temperature	
Checking (tyre pressure monitoring system)	328
Tyre pressure monitoring system (function)	328
Tyre tread	311
Tyre-change tool kit	334
Tyres	
Checking	311
Checking the tyre pressure (tyre pressure monitoring system)	328
Direction of rotation	334
Fitting	339
Flat tyre	294
M+S tyres	311
Noise	311
Notes on fitting	332
Removing	338
Replacing	332, 335
Restarting the tyre pressure monitor	329
Selecting	332
Snow chains	312
Storing	334
Summer tyres	311
Tyre pressure (Notes)	313
Tyre pressure monitoring system (function)	328
Tyre pressure table	314
Unusual driving characteristics	311
Wheel size categories	334

U

Units of measurement	
Setting	217
Unlocking setting	46
Unlocking/locking	
Additional door lock	47
Switching automatic locking feature on/off	49
Unlocking and opening front doors from inside	48
USB socket in the rear	83
User profile	205
Using kickdown	131
Using the chock	151

V

Vehicle	115
Additional door lock	47
Correct use	28
Data recording	28
Diagnostics connection	27
Equipment	24
Implied warranty	28
Locking (automatic)	49
Locking/unlocking (emergency key element)	49
Lowering	340
Parking (start/stop button)	146
parking up	150
QR code rescue card	28
Qualified specialist workshop	27
Raising	336
REACH regulation	28
Registration	28
Starting (in emergency operation mode)	115
Starting (start/stop button)	115
Switching on power supply (start/stop button)	114
Unlocking (from inside)	48
Ventilating (convenience opening)	59
Voice commands (LINGUATRONIC) ..	197
Vehicle data	
Showing	219
Transferring to Android Auto™	257
Transferring to Apple CarPlay™	257
Vehicle height	357
Vehicle length	357
Vehicle width	357
Wheelbase	357

- Vehicle data memory**
 Electronic control units 28
 Service providers 30
- Vehicle dimensions** 357
- Vehicle identification number**
 see VIN
- Vehicle identification plate**
 EU general operating permit number 348
 Paint code 348
 Permissible axle load 348
 Permissible gross mass 348
 VIN 348
- Vehicle identification plate**
 see Model series
- Vehicle key**
 see Key
- Vehicle level**
 Lowering 137
 Raising 137
- Vehicle maintenance**
 see ASSYST PLUS
- Vehicle tool kit** 307, 309
- Vehicle tool kit stowage compartment** 309
- VIN** 348
 Identification plate 348
 Reading out 348
 Seat 348
 Windscreen 348
- Voice command types (LINGUATRONIC)** 189
- Voice control system**
 see LINGUATRONIC
- W**
- Warning and indicator lamps**
 Overview 382
- Warning lamp** 291
- Warning triangle**
 Removing 291
 Setting up 291
- Warning/indicator lamp** 8
 ABS warning lamp 386
 Brake system warning lamp
 (red) 384
 Brake system warning lamp
 (yellow) 384
 Coolant warning lamp 388
 Distance warning warning
 lamp 387
 Electric parking brake applied
 red indicator lamp lights up 382, 383
 Electric parking brake mal-
 functioning yellow indicator lamp
 lights up 382, 383
 Electric parking brake red
 indicator lamp engaged flashes 383
 Electrical fault warning lamp 388
 Engine diagnosis warning
 lamp 389
 ESP® OFF warning lamp 386
 ESP® warning lamp flashes 385
 ESP® warning lamp lights up 385
 Fuel reserve warning lamp 388
 Parking brake applied red
 indicator lamp lights up 384
 Power steering system warn-
 ing lamp 387
 Restraint system warning
 lamp 385
 Seat belt warning lamp
 flashes 387
 Seat belt warning lamp lights
 up 387
 The electric parking brake
 malfunctioning yellow indicator
 lamp does not light up 383
 Tyre pressure monitoring sys-
 tem warning lamp flashes 389
 Tyre pressure monitoring sys-
 tem warning lamp lights up 389
- Warranty** 28
- Washer fluid**
 see Windscreen washer fluid (notes)
- Washing by hand (care)** 286
- Weather information** 244
- Web browser**
 Calling up a web page 260
 Calling up options 261
 Calling up the settings 261
 Deleting a bookmark 261

- Deleting Internet history 261
- Ending 262
- Managing bookmarks 261
- Overview 261
- Website**
- Calling up 260
- Wheel rotation** 334
- Wheel size categories** 334
- Wheel spanner** 334
- Wheels**
- Care 287
- Changing 334
- Checking 311
- Checking the tyre pressure (tyre pressure monitoring system) 328
- Fitting 339
- Flat tyre 294
- Noise 311
- Notes on fitting 332
- Removing 338
- Replacing 332, 335
- Restarting the tyre pressure monitor 329
- Selecting 332
- Snow chains 312
- Storing 334
- Tyre pressure (Notes) 313
- Tyre pressure monitoring system (function) 328
- Tyre pressure table 314
- Unusual driving characteristics 311
- Wi-Fi** 215
- Adjusting 215
- Overview 215
- Setting up a hotspot 216
- Setting up an Internet connection 258
- Window airbag** 35
- Windows**
- see Side window
- Windows (care)** 287
- Windscreen** 97
- Replacing the wiper blades 97
- Replacing the wiper blades (WET WIPER SYSTEM) 98
- Windscreen washer fluid**
- Information 356
- Windscreen washer fluid (notes)** 356
- Windscreen wipers**
- Replacing the wiper blades 97
- Replacing the wiper blades (WET WIPER SYSTEM) 98
- switching on/off 97
- Windshield**
- see Windscreen
- Winter driving (snow chains)** 312
- Winter tyres** 311
- Setting the permanent speed limitation 159
- Wiper blades**
- Care 287
- Replacing (rear window) 99
- Replacing (WET WIPER SYSTEM) 98
- Replacing (windscreen) 97
- Wireless charging**
- Function/notes 83
- Mobile phone 84
- Wireless vehicle components (declaration of conformity)** 25
- Workshop**
- see Qualified specialist workshop

Publication details

Internet

Further information about Mercedes-Benz vehicles and about Daimler AG can be found on the following websites:

<http://www.mercedes-benz.com>

<http://www.daimler.com>

Documentation team

You are welcome to forward any queries or suggestions you may have regarding these Operating Instructions to the technical documentation team to the following address:

Daimler AG, HPC: CAC, Customer Service, 70546 Stuttgart, Germany

©Daimler AG: not to be reprinted, translated or otherwise reproduced, in whole or in part, without written permission from Daimler AG.

Vehicle manufacturer

Daimler AG

Mercedesstraße 137

70327 Stuttgart

Germany

YOUR OPERATING INSTRUCTIONS



Digital in the vehicle

Familiarise yourself with the contents of the Operating Instructions directly via the vehicle's multimedia system (Menu item "Vehicle"). Start with the quick guide or deepen your knowledge with practical tips.



Vehicle document wallet in the vehicle

Here you can find information on operation, service work and the guarantee for your vehicle in printed form.



Digital on the Internet

You can access the Operating Instructions on the Mercedes-Benz homepage.



Digital as an app

The Mercedes-Benz Guides app is available free of charge in common app stores.



Apple® iOS



Android™



9075840903Z102