



# Sprinter

Operating Instructions

Mercedes-Benz



## Symbols

In this Owner's Manual, you will find the following symbols:

 **DANGER** Danger due to not observing the warning notices

Warning notices draw your attention to hazards that may endanger your health or life, or the health or life of others.

▶ Please observe the warning notices in this Owner's Manual.

 **ENVIRONMENTAL NOTE** Environmental damage due to failure to observe environmental notes

Environmental notes include information on environmentally responsible behaviour or environmentally responsible disposal.

▶ Observe environmental notes.

 **NOTE** Damage to property due to failure to observe notes on material damage

Notes on material damage inform you of risks which may lead to your vehicle being damaged.

▶ Observe notes on material damage.

 These symbols indicate useful instructions or further information that could be helpful to you.

▶ Instructions

( → page) Further information on a topic

Display Display in the multifunction display/multimedia display

 Highest menu level to be selected in the multimedia system

 Corresponding submenus to be selected in the multimedia system

\* Indicates a cause

## Welcome to the world of Mercedes-Benz

Before you first drive off, read this Owner's Manual carefully and familiarise yourself with your vehicle. For your own safety and a longer vehicle life, follow the instructions and warning notices in this Owner's Manual. Disregarding them may result in damage to the vehicle or environment or in personal injury.

The equipment or model designation of your vehicle may vary according to:

- model
- order
- national version
- availability

The illustrations in this Owner's Manual show a left-hand drive vehicle. On right-hand drive vehicles, the layout of components and control elements differs accordingly.

Mercedes-Benz is constantly updating its vehicles to the state of the art.

Mercedes-Benz therefore reserves the right to introduce changes in the following areas:

- design
- equipment
- technical features

Therefore, the description may differ from your vehicle in some cases.

The following are integral parts of the vehicle:

- Digital Owner's Manual
- printed Owner's Manual
- service booklet
- equipment-dependent supplements

Always keep these documents in the vehicle. If you sell the vehicle, always pass all documents on to the new owner.



<b>At a glance</b> .....	<b>4</b>	<b>Seats and stowage</b> .....	<b>60</b>
Cockpit .....	4	Correct driver's seat position .....	60
Instrument cluster .....	5	Seats .....	60
Overhead control panel .....	10	Adjusting the steering wheel .....	72
Door control panel .....	14	Stowage areas .....	73
Emergencies and breakdowns .....	16	Information about the bottle holder .....	77
		Cup holder .....	77
		Ashtray and cigarette lighter .....	77
		Sockets .....	78
		Wirelessly charging the mobile phone and coupling with the exterior aerial .....	80
		Fitting or removing the floor mats .....	81
<b>Digital Owner's Manual</b> .....	<b>18</b>		
Calling up the Digital Operating Instructions .....	18		
<b>General notes</b> .....	<b>19</b>	<b>Light and vision</b> .....	<b>82</b>
Environmental protection .....	19	Exterior lighting .....	82
Take-back of end-of-life vehicles .....	19	Adjusting the interior lighting .....	85
Mercedes-Benz GenuineParts .....	19	Changing bulbs .....	87
Information about attachments, add- on equipment, installations and con- versions .....	20	Windscreen wipers .....	92
Operating Instructions .....	21	Mirrors .....	95
Operating safety .....	21	Operating sun visors .....	96
Declarations of conformity .....	22		
Diagnostics connection .....	23	<b>Climate control</b> .....	<b>97</b>
Notes on changes to the engine output .....	23	Overview of climate control systems .....	97
Qualified specialist workshop .....	23	Operating climate control systems .....	99
Vehicle registration .....	24	Operating air vents .....	102
Correct use of the vehicle .....	24	Auxiliary heating .....	103
Implied warranty .....	24	Operating load compartment ventila- tion .....	109
QR codes for rescue card .....	24		
Data storage .....	24		
Copyright .....	26		
<b>Occupant safety</b> .....	<b>27</b>	<b>Driving and parking</b> .....	<b>110</b>
Restraint system .....	27	Driving .....	110
Seat belts .....	28	Battery main switch .....	122
Airbags .....	31	Manual transmission .....	122
Children in the vehicle .....	32	Automatic transmission .....	123
Notes on pets in the vehicle .....	40	All-wheel drive .....	127
		DSR (Downhill Speed Regulation) .....	128
		Electronic level control .....	129
		Refuelling .....	133
		Parking .....	140
		Driving and driving safety systems .....	145
		Work mode .....	168
		Trailer operation .....	169
<b>Opening and closing</b> .....	<b>41</b>	<b>Instrument Display and on-board computer</b> .....	<b>174</b>
Key .....	41	Overview of instrument display .....	174
Doors .....	43	Overview of the buttons on the steer- ing wheel .....	175
Sliding door .....	46	Operating the on-board computer .....	175
Electrical sliding door .....	47	Overview of the displays on the multi- function display .....	176
Rear-end doors .....	50		
Partition sliding door .....	51		
Electrical step .....	52		
Platform dropsides .....	53		
Side window .....	55		
Anti-theft protection .....	57		

Setting the instrument lighting .....	177	Tyre pressure .....	303
Menus and submenus .....	177	Changing a wheel .....	318
		Spare wheel .....	327
<b>LINGUATRONIC .....</b>	<b>182</b>		
Notes on operating safety .....	182	<b>Technical data .....</b>	<b>333</b>
Operation .....	182	Information on technical data .....	333
Using LINGUATRONIC effectively .....	184	On-board electronics .....	333
Basic voice commands .....	184	Vehicle identification plate, vehicle identification number (VIN) and engine number .....	334
		Operating fluids and capacities .....	335
<b>MBUX multimedia system .....</b>	<b>192</b>	Vehicle data .....	341
Overview and operation .....	192	Trailer hitch .....	341
System settings .....	204	Lashing points and carrier systems .....	342
Vehicle information .....	210		
Navigation .....	211	<b>Display messages and warning and indicator lamps .....</b>	<b>345</b>
Telephone .....	234	Display messages .....	345
Online and Internet functions .....	250	Warning and indicator lamps .....	369
Media .....	256		
Radio .....	260	<b>Index .....</b>	<b>379</b>
Sound .....	262		
<b>Transporting .....</b>	<b>263</b>		
Notes on loading guidelines .....	263		
Load distribution .....	264		
Securing loads .....	264		
Carrier systems .....	266		
Interior roof rack system .....	267		
Placing a load on the wheel arch .....	269		
<b>Maintenance and care .....</b>	<b>270</b>		
ASSYST PLUS service interval display .....	270		
Engine compartment .....	270		
Cleaning and care .....	278		
<b>Breakdown assistance .....</b>	<b>283</b>		
Emergency .....	283		
Flat tyre .....	284		
Battery .....	284		
Towing or tow-starting .....	293		
Electrical fuses .....	298		
Vehicle tool kit .....	299		
Hydraulic jack .....	300		
<b>Wheels and tyres .....</b>	<b>301</b>		
Noise or unusual driving characteris- tics .....	301		
Regular checking of wheels and tyres .....	301		
Information on driving with summer tyres .....	301		
Information on M+S tyres .....	301		
Notes on snow chains .....	302		

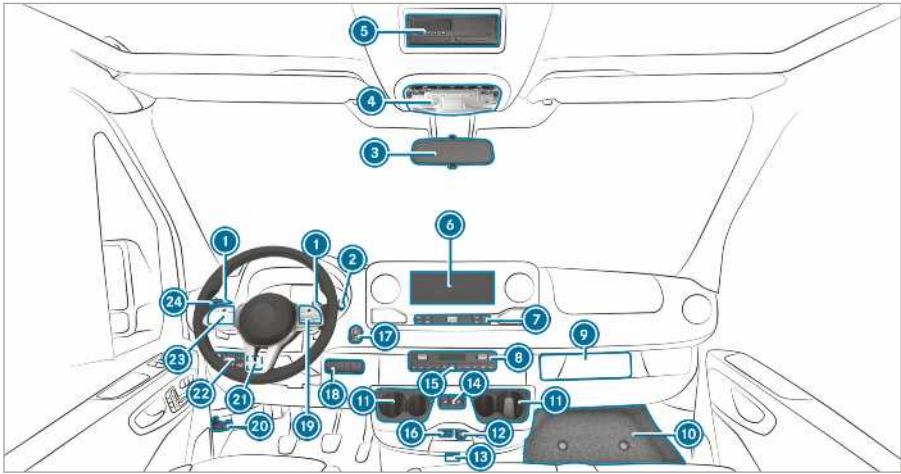

① Steering wheel gearshift paddles	→ 125	Activates/deactivates all-wheel drive	→ 128
② DIRECT SELECT lever	→ 123	Engages/disengages LOW RANGE	→ 128
③ Rear-view mirror	→ 96	Activates/deactivates DSR	→ 129
④ Overhead control panel	→ 85	Raises/lowers the vehicle level	→ 131
⑤ DIN slot, e.g. for mounting a tachograph or the timer for the stationary heater		Activating/deactivating power take-off	→ 168
⑥ MBUX multimedia system display	→ 192	Activates/deactivates working speed control (ADR)	→ 169
⑦ MBUX multimedia system control elements	→ 195	Activates/deactivates load compartment ventilation	→ 109
⑧ Climate control system	→ 97	⑲ Steering-wheel buttons	→ 175
⑨ Tachograph housing		⑳ Opens the bonnet	→ 270
⑩ Stowage compartment cover	→ 299	㉑ Left-hand switch panel	
⑪ Cup holder	→ 77	Sets the working speed (ADR)	→ 169
⑫ 12 V socket	→ 78	㉒ Light switch	
⑬ Vehicles with KEYLESS START: key slot		Headlamp range adjuster	→ 83
⑭ Opens and closes the electric sliding door	→ 47	㉓ Steering-wheel buttons	→ 175
⑮ Switches the hazard warning lights on and off	→ 84	㉔ Combination switch	
⑯ USB port	→ 74	Flashing	→ 83
⑰ Start/stop button	→ 111	High beam	→ 83
⑱ Right-hand switch panel		Windscreen wipers	→ 92
		Rear window wiper	→ 93

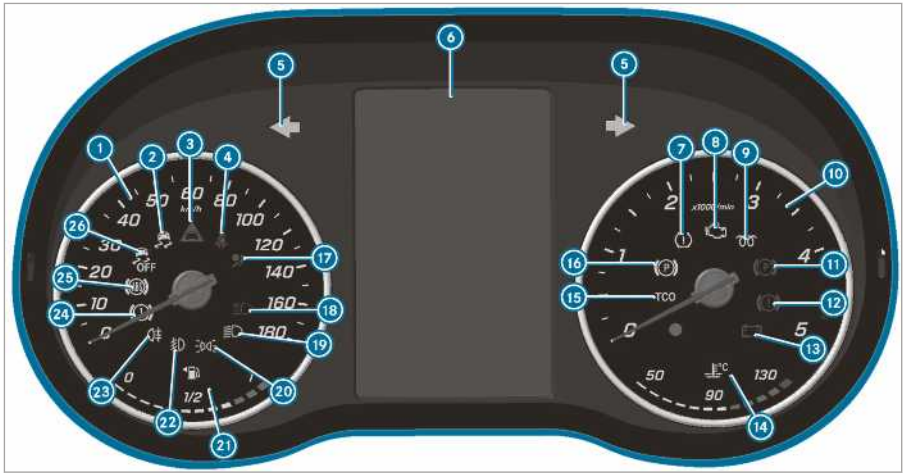

## Instrument display (colour display)

①	Speedometer	→ 174
②	ESP®	→ 369
③	Distance warning	→ 375
④	Safety belt not fastened	→ 375
⑤	Turn signal light	→ 83
⑥	Multifunction display	→ 369
⑦	Tyre pressure loss warning lamp	→ 369
⑧	Engine diagnostics	→ 376
⑨	Preglow and malfunction in preglow system	
⑩	Rev counter	→ 174
⑪	Parking brake applied (red)	→ 369, 369
⑫	Brakes (red)	→ 369
⑬	Electrical fault	→ 376
⑭	Coolant temperature indicator and coolant too hot	→ 376
⑮	Tachograph (see separate operating manual)	
⑯	Electric parking brake (yellow)	→ 369
⑰	Restraint system	→ 27
⑱	High beam	→ 83
⑲	Dipped beam	→ 82
⑳	Standing light	→ 82
㉑	Fuel level indicator and fuel reserve with fuel filler flap location indicator	→ 376
㉒	Fog light	→ 82
㉓	Rear fog light	→ 82
㉔	Brakes (yellow)	→ 369
㉕	ABS malfunctioning	→ 369
㉖	ESP® deactivated	→ 369



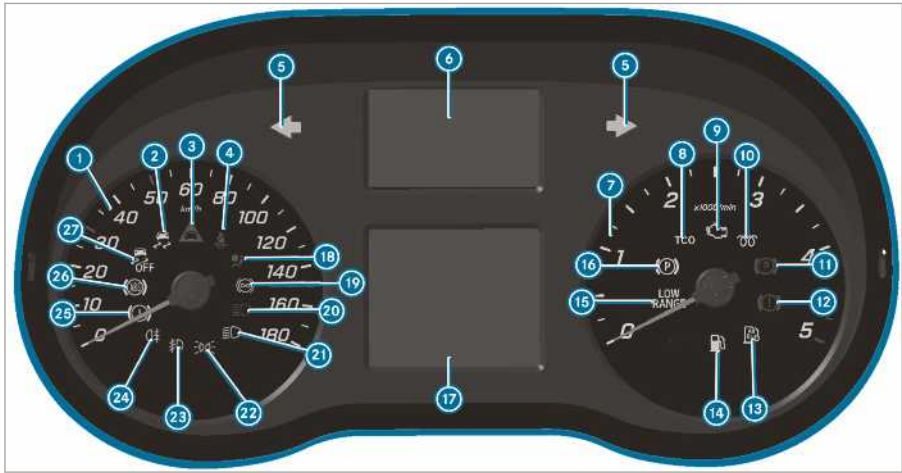





Instrument display (black and white display) with steering wheel buttons

①	Speedometer	→	174
②	ESP®	→	369
③	Distance warning	→	375
④	Safety belt not fastened	→	375
⑤	Turn signal light	→	83
⑥	Display of warning and indicator lamps		
	At least one door is not completely closed		
	Tyre pressure loss	→	369
	Power-assisted steering malfunctioning	→	375
	Electrical fault	→	376
	SOS emergency call system (Mercedes-Benz emergency call system)		
	Active Brake Assist deactivated		
	ATTENTION ASSIST deactivated		
	Lane Keeping Assist inactive		
	Highbeam Assist	→	85

	(White) Lane Keeping Assist active and ready to issue warnings /  (Red) Lane Keeping Assist issues warning		
⑦	Rev counter		
⑧	Tachograph (see separate operating manual)		
⑨	Engine diagnostics	→	376
⑩	Preglow and malfunction in preglow system		
⑪	Parking brake applied (red)	→	369, 369
⑫	Brakes (red)	→	369
⑬	AdBlue level low	→	135
⑭	Reserve fuel	→	376
⑮	LOW RANGE active	→	128
⑯	Electric parking brake (yellow)	→	369
⑰	Multifunction display	→	369
⑱	Restraint system	→	27
⑲	Retarder (see separate operating manual)		
⑳	Highbeam	→	83
㉑	Dipped beam	→	82
㉒	Standing light	→	82



---

	→	82		→	369
Fog light				→	369
	→	82		→	369
Rear fog light					

---

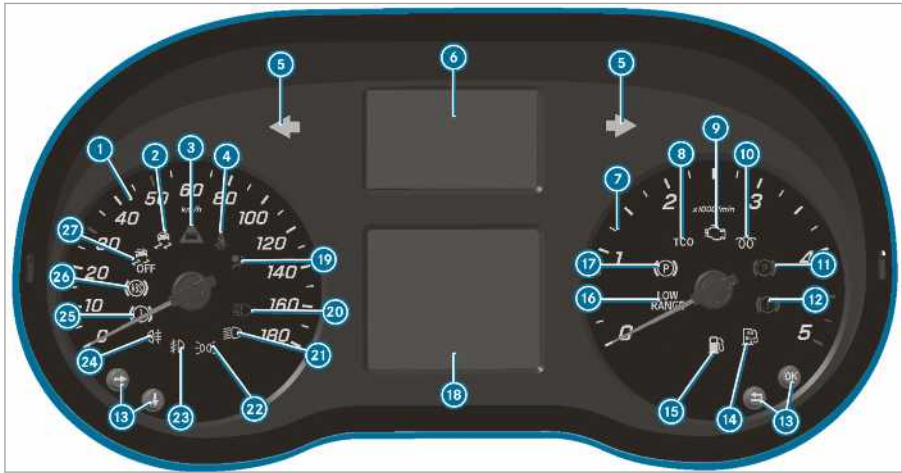









Instrument display (black and white display) without steering wheel buttons

①	Speedometer	→	174
②	ESP®	→	369
③	Distance warning	→	375
④	Safety belt not fastened	→	375
⑤	Turn signal light	→	83
⑥	Display of warning and indicator lamps		
	At least one door is not completely closed		
	Tyre pressure loss warning lamp	→	369
	Power-assisted steering malfunctioning	→	375
	Electrical fault	→	376
	SOS emergency call system (Mercedes-Benz emergency call system)		
	Active Brake Assist deactivated		
	ATTENTION ASSIST deactivated		
	Lane Keeping Assist inactive		

	Highbeam Assist	→	85
	(White) Lane Keeping Assist active and ready to issue warnings / (Red) Lane Keeping Assist issues warning		
	Retarder (see separate operating manual)		
⑦	Rev counter		
⑧	Tachograph (see separate operating manual)		
⑨	Engine diagnosis	→	376
⑩	Preglow and malfunction in preglow system		
⑪	Parking brake applied (red)	→	369, 369
⑫	Brakes (red)	→	369
⑬	Buttons to operate the on-board computer	→	175
⑭	AdBlue level low	→	135
⑮	Reserve fuel	→	376
⑯	LOW RANGE active	→	128
⑰	Electric parking brake (yellow)	→	369
⑱	Multifunction display	→	369
⑲	Restraint system	→	27







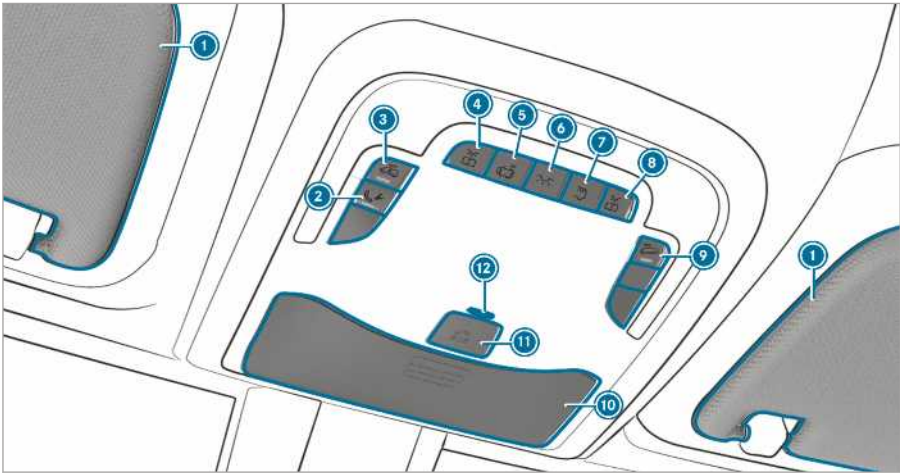

---

 20	High beam	→	83	 24	Rear fog light	→	82
 21	Dipped beam	→	82	 25	Brakes (yellow)	→	369
 22	Standing light	→	82	 26	ABS malfunctioning	→	369
 23	Fog light	→	82	 27	ESP® deactivated	→	369

---





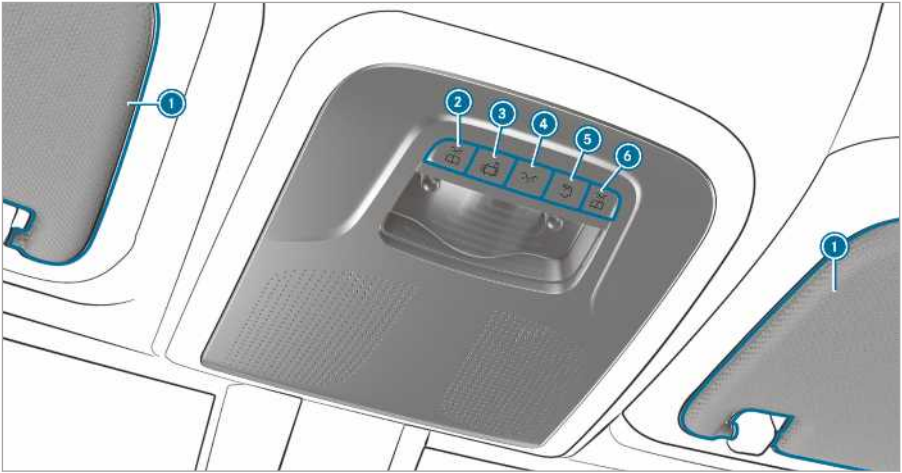

Version 1 of the overhead control panel

- |  |  |
|--|--|
| <p>① Sun visors → 96</p> <hr/> <p>② Breakdown assistance call button (Mercedes PRO connect)</p> <hr/> <p>③  Activates/deactivates interior protection → 59<br/>or activates/deactivates the bus interior lighting</p> <hr/> <p>④  Switches the left-hand reading light on/off</p> <hr/> <p>⑤  Switches automatic light control on/off</p> <hr/> <p>⑥  Switches the front interior lighting on/off</p> | <p>⑦  Switches the rear interior lighting on/off</p> <hr/> <p>⑧  Switches the right-hand reading light on/off</p> <hr/> <p>⑨  Switches tow-away protection on/off → 58</p> <hr/> <p>⑩ Glasses compartment → 75</p> <hr/> <p>⑪  SOS/emergency call system (Mercedes-Benz emergency call system)</p> <hr/> <p>⑫ ATA indicator lamp or emergency call system support battery LED indicator lamp (Russia only)</p> |
|--|--|



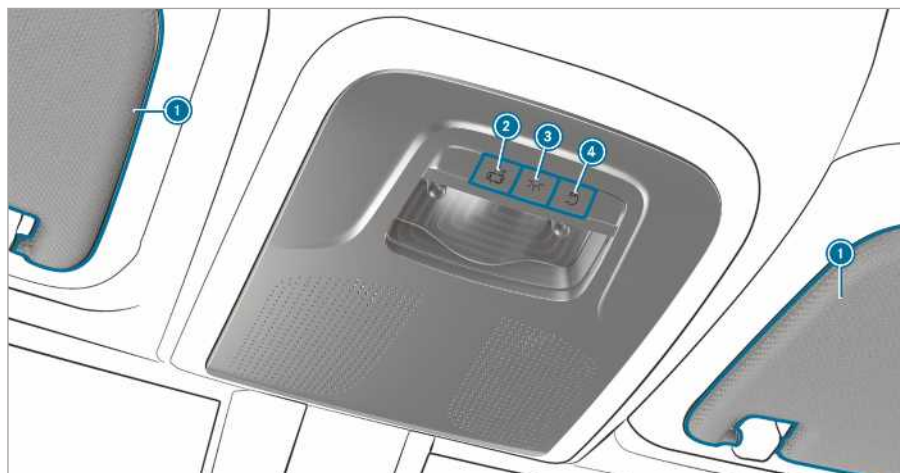

## Version 2 of the overhead control panel

- |  |      |   |
|--|------|---|
| <p>① Sun visors</p> <hr/> <p>②  Switches the left-hand reading light on/off</p> <hr/> <p>③  Switches automatic light control on/off</p> <hr/> <p>④  Switches the front interior lighting on/off</p> | → 96 | <p>⑤  Switches the rear interior lighting on/off</p> <hr/> <p>⑥  Switches the right-hand reading light on/off</p> |
|--|------|---|



Version 3 of the overhead control panel

- |   |   |    |   |   |    |
|---|---|----|---|---|----|
| ① Sun visors  | → | 96 | ③  Switches the front interior lighting on/off | → | 59 |
| ②  Switches automatic light control on/off |   |    |   |   |    |
|   |   |    | ④  Switches the rear interior lighting on/off  |   |    |

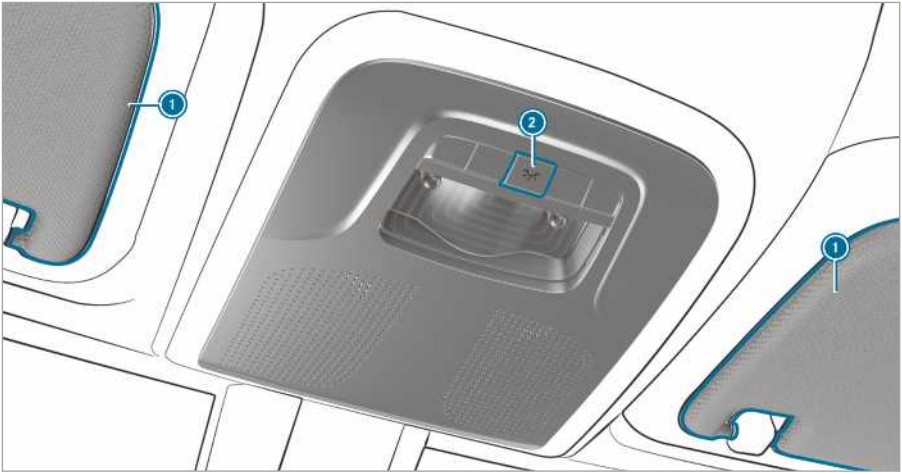

Version 4 of the overhead control panel

- ① Sun visors → 96
- ② Activates/deactivates interior lighting



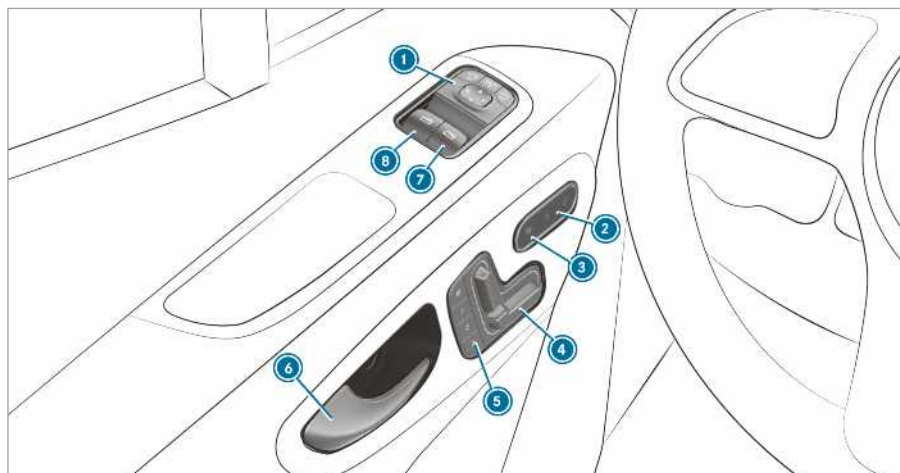

Door control panel in vehicles with electrically adjustable seats

① To adjust the outside mirrors	→ 95	⑤ Operating the memory function	→ 65
② To activate/deactivate the central locking system	→ 45	⑥ To open a door	→ 44
③ To switch seat heating on/off	→ 72	⑦ To open/close the right-hand side window	→ 55
④ To adjust the front seats electronically	→ 63	⑧ To open/close the left-hand side window	→ 55

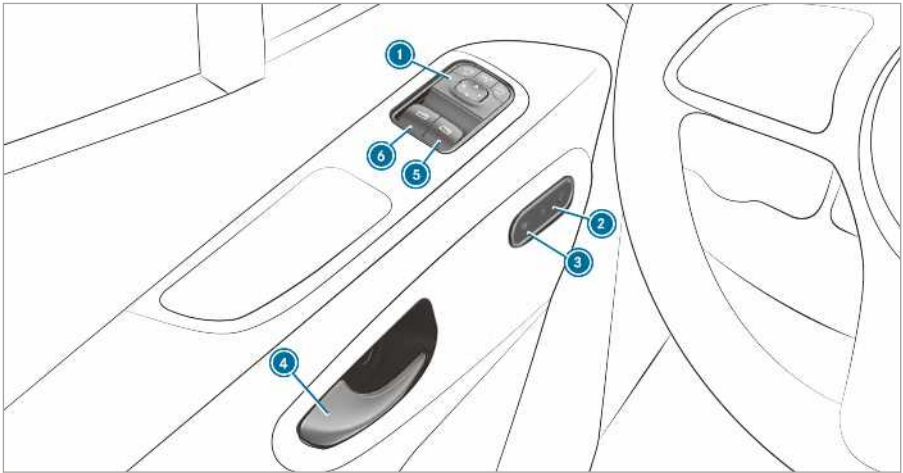

Door control panel vehicles without electrically adjustable seats

① To adjust the outside mirrors	→ 95	⑤ To open/close the right-hand side window	→ 55
② To activate/deactivate the central locking system	→ 45	⑥ To open/close the left-hand side window	→ 55
③ To switch seat heating on/off	→ 72		
④ To open a door	→ 44		

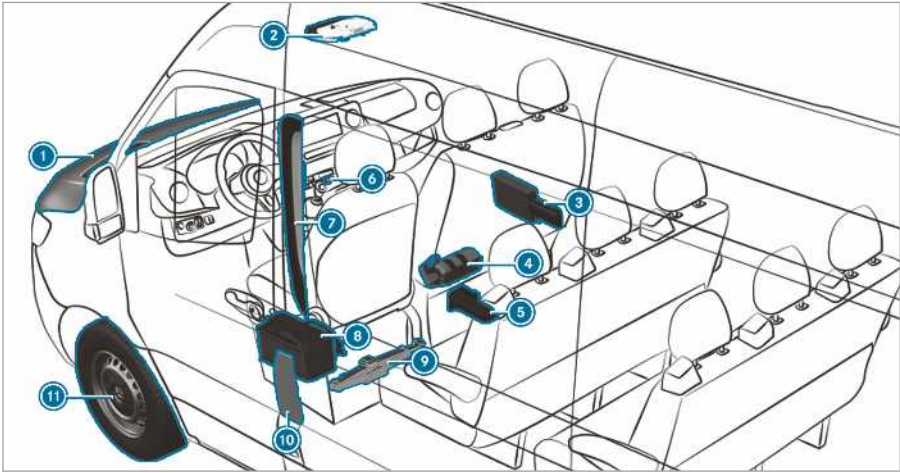

<p>① To check and top up operating fluids → 335</p> <p>Starting assistance → 286</p> <p>② Buttons for the SOS emergency call system and breakdown assistance → 249</p> <p>③ Warning triangle → 283</p> <p>Safety vest → 283</p> <p>First-aid kit (soft sided) → 283</p> <p>④ Fire extinguisher → 283</p> <p>⑤ Vehicles with rear wheel drive: hydraulic jack and tyre-change tool kit → 300</p>	<p>⑥ Hazard warning lights → 84</p> <p>⑦ QR codes for determining the rescue card → 24</p> <p>⑧ Disconnecting the starter battery → 288</p> <p>⑨ Vehicles with front wheel drive: mechanical jack and tyre-change tool kit → 320</p> <p>⑩ Fuel filler flap with instruction labels for tyre pressure, fuel type and QR codes for determining the rescue card → 133</p> <p>⑪ Flat tyre → 284</p>
---	---

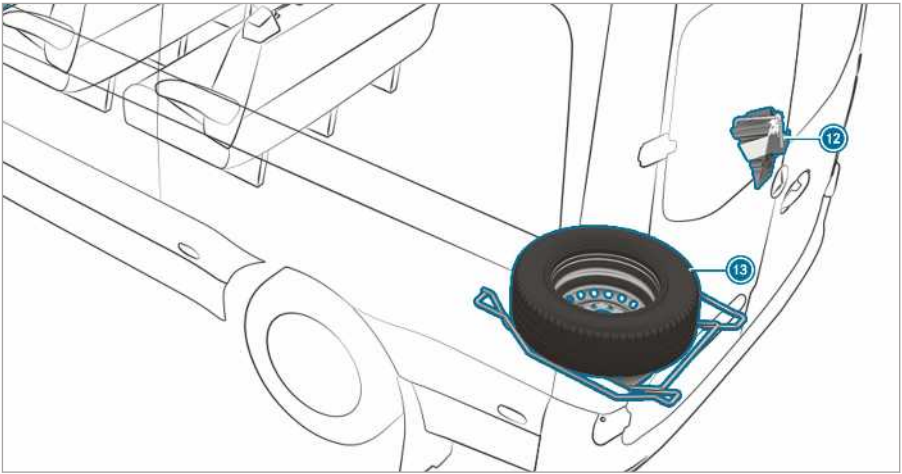

12 Vehicles with rear wheel drive:  
chock

13 Example: spare wheel

→ 327

## Calling up the Digital Operating Instructions

Multimedia system:

↳ Vehicle info ▶ Owner's Manual ▶ ⓘ



The Digital Operating Instructions describes the function and operation of:

- the vehicle
- the multimedia system

▶ Select one of the following menu items in the Digital Operating Instructions:

- **Search:** here you can use keywords to quickly locate answers to questions concerning vehicle operation.
- **Quick start:** the first steps towards setting up your driver's seat can be found here.
- **Tips:** provides you with information on specific everyday situations.
- **Bookmarks:** you can access your saved personal bookmarks here.
- **Language:** you can set the languages for the Digital Operating Instructions here.

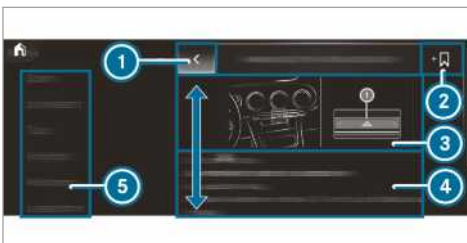

- 1 Back
- 2 Add bookmarks
- 3 Picture
- 4 Content area
- 5 Menu

Some sections of the Digital Operating Instructions, e.g. warnings, can be expanded and collapsed.

## Additional options for calling up the Digital Operating Instructions

**Deep link:** pressing and holding down an entry in the tab of the multimedia system opens the corresponding content in the Digital Operating Instructions:



**LINGUATRONIC:** calling up via the voice control system

The Digital Operating Instructions are deactivated for safety reasons while driving.

- ⓘ The Operating Instructions can also be found in the Mercedes-Benz Guides App in all common app stores.

## Environmental protection

 **ENVIRONMENTAL NOTE** Environmental damage due to operating conditions and personal driving style

The pollutant emission of your vehicle is directly related to the way you operate your vehicle.

You can help to protect the environment by operating your vehicle in an environmentally responsible manner. Please observe the following recommendations on operating conditions and personal driving style.

### Operating conditions:

- ▶ Make sure that the tyre pressure is correct.
- ▶ Do not carry any unnecessary weight (e.g. roof luggage racks once you no longer need them).
- ▶ Adhere to the service intervals. A regularly serviced vehicle will contribute to environmental protection.
- ▶ Always have service work carried out at a qualified specialist workshop.

### Personal driving style:

- ▶ Do not depress the accelerator pedal when starting the engine.
- ▶ Do not warm up the engine while the vehicle is stationary.
- ▶ Drive carefully and maintain a suitable distance from the vehicle in front.
- ▶ Avoid frequent, sudden acceleration and braking.
- ▶ Change gear in good time and use each gear only up to  $\frac{2}{3}$  of its maximum engine speed.
- ▶ Switch off the engine in stationary traffic, e.g. by using the ECO start/stop function.
- ▶ Drive in a fuel-efficient manner.

## Take-back of end-of-life vehicles

### EU countries only:

Mercedes-Benz will take back your end-of-life vehicle for environment-friendly disposal in accordance with the European Union (EU) End-Of-Life Vehicles Directive.

A network of vehicle take-back points and dismantlers has been established for you to return your vehicle. You can leave it at any of these points free of charge. This makes an important contribution to closing the recycling circle and conserving resources.

For further information about the recycling and disposal of end-of-life vehicles, and the take-back conditions, please visit the national Mercedes-Benz website for your country.

## Mercedes-Benz GenuineParts

 **ENVIRONMENTAL NOTE** Environmental damage caused by not using recycled/reconditioned components

Daimler AG offers recycled/reconditioned components and parts with the same quality as new parts. The same entitlement from the implied warranty is valid as for new parts.

- ▶ Use recycled/reconditioned components and parts from Daimler AG.

 **NOTE** The effectiveness of the restraint systems can be impaired by installing accessory parts, performing repairs or welding operations

Airbags, seat belt tensioners as well as control units and sensors for the restraint systems can be fitted in the following areas of the vehicle:

- door frames
- roof frames
- doors
- door pillars
- door sills
- seats
- cockpit
- instrument cluster
- centre console

- ▶ Do not install any accessories such as audio systems in these areas.
- ▶ Do not perform repairs or welding operations.
- ▶ Have accessory parts retrofitted at a qualified specialist workshop.

If you use parts, tyres, wheels or safety-relevant accessories which have not been approved by Mercedes-Benz, the operating safety of the vehicle may be jeopardised. Safety-relevant systems, e.g. the brake system, may malfunction. Use only Mercedes-Benz GenuineParts or parts of equal quality. Use only tyres, wheels and accessory parts that are approved for your vehicle model.

Mercedes-Benz tests original parts, conversion parts and accessory parts that have been approved for your vehicle model for reliability, safety and suitability. Despite ongoing market research, Mercedes-Benz is unable to assess other parts. Mercedes-Benz accepts no responsibility for the use of such parts in Mercedes-Benz vehicles, even if they have been officially approved or independently approved by a testing centre.

Certain parts are only officially approved for installation or modification if they comply with legal requirements. All Mercedes-Benz GenuineParts meet the approval requirements. The use of non-approved parts may invalidate the vehicle's general operating permit.

This is the case in the following situations:

- the vehicle type changes from that stated in the general operating permit.
- other road users could be endangered.
- the emissions or noise levels are adversely affected.

Always specify the vehicle identification number (VIN) when ordering Mercedes-Benz GenuineParts (→ page 334).

### Information about attachments, add-on equipment, installations and conversions

For safety reasons, have add-on equipment produced and assembled in accordance with the valid Mercedes-Benz add-on equipment guidelines. These add-on equipment guidelines ensure that the chassis and add-on equipment form one unit and that the greatest possible level of operational and driving safety is achieved.

Both vehicle manufacturers as well as body manufacturers must always ensure that the products manufactured by them come into circulation only in a safe state and do not pose any risks to people. Otherwise, there may be consequences under civil, criminal or public law. All manufacturers are responsible for the products that they have manufactured. The manufacturer of attach-

ments, add-on equipment, inserts and conversions must guarantee compliance with Directive 2001/95/EC on general product safety.

For safety reasons, Mercedes-Benz recommends the following:

- Do not make any other changes to the vehicle.
- Obtain approval from Mercedes-Benz in the event of deviations from the approved add-on equipment guidelines.

Acceptance tests performed by public test bodies or official approvals do not rule out safety risks.

Comply with the information about Mercedes-Benz GenuineParts (→ page 19).

You will find the Mercedes-Benz add-on equipment guidelines on the internet at [https://bb-portal.mercedes-benz.com/portal/kat\\_iv.html?&L](https://bb-portal.mercedes-benz.com/portal/kat_iv.html?&L).

You will also find information about the PIN assignment and changing the fuse there.

- ① Further information can be obtained at a qualified specialist workshop.

**⚠ WARNING** Risk of accident and injury in the event of incorrect conversions or changes to the vehicle

Conversions or changes to the vehicle can impair the function of systems or components.

As a result, they may no longer function as intended and/or endanger the operating safety of the vehicle.

- ▶ Always have conversions or changes to the vehicle made at a qualified workshop.

Even seemingly minor changes to the vehicle, such as attaching a radiator grille in winter, are not permitted. Do not cover the engine radiator. Do not use any thermal mats, insect protection covers etc.

Otherwise, the values of the vehicle's diagnosis system will be distorted. In some countries, the recording of engine diagnosis data is prescribed by law and must be verifiable and correct at all times.

The factory fits the vehicle with the wooden or plastic load compartment floor; this is an integral part of the vehicle structure. If you have the load compartment floor removed, the vehicle body may be damaged. The load retainer will then be



impaired and the maximum loading capacity of the tie-down points will no longer be guaranteed. Therefore, do not have the load compartment floor removed.

### Operating Instructions

This Owner's Manual describes all models and all standard and special equipment available for your vehicle at the time of going to press of the Owner's Manual. Country-specific differences are possible. Note that your vehicle may not be fitted with all functions described. This is also the case for systems and functions relevant to safety. Therefore, the equipment on your vehicle may differ from that in the descriptions and illustrations.

The original purchase agreement documentation for your vehicle contains a list of all the systems in your vehicle.

Should you have any questions concerning equipment and operation, please consult a Mercedes-Benz service centre.

The Owner's Manual and Service Booklet are important documents and should be stored in the vehicle.

### Operating safety

**⚠ WARNING** Risk of accident due to malfunctions or system failures

If you do not have the prescribed service/maintenance work or any required repairs carried out, this could result in malfunctions or system failures.

- ▶ Always have the prescribed service/maintenance work as well any required repairs carried out at a qualified specialist workshop.

**⚠ WARNING** Risk of accident or injury due to incorrect modifications on electronic component parts

Modification to electronic components, their software or wiring could impair their function and/or the function of other networked component parts. In particular, systems relevant to safety could also be affected.

As a result, these may no longer function properly and/or jeopardise the operating safety of the vehicle.

- ▶ Never tamper with the wiring and electronic component parts or their software.
- ▶ You should have all work on electrical and electronic components carried out at a qualified specialist workshop.

If you make any changes to the on-board electronics, the general operating permit is rendered invalid.

**⚠ WARNING** Risk of fire due to flammable materials on hot parts of the exhaust system

Flammable material such as leaves, grass or twigs may ignite if they come into contact with hot parts of the exhaust system.

- ▶ When driving on unpaved roads or off-road, regularly check the vehicle underside.
- ▶ Remove trapped plants or other flammable material, in particular.
- ▶ If there is damage, consult a qualified specialist workshop immediately.

**! NOTE** Damage to the vehicle

In the following situations, in particular, there is a risk of damage to the vehicle:

- the vehicle becomes grounded, e.g. on a high kerb or an unpaved road
- the vehicle is driven too fast over an obstacle, e.g. a kerb, speed bump or pothole
- a heavy object strikes the underbody or chassis components

In situations such as this, the body, the underbody, chassis components, wheels or tyres could be damaged without the damage being visible. Components damaged in this way can unexpectedly fail or, in the case of an accident, may not absorb the loads that arise as intended.

If the underbody panelling is damaged, flammable materials such as leaves, grass or twigs can collect between the underbody and the underbody panelling. These materials may ignite if they come into contact with hot parts on the exhaust system.

▶ Have the vehicle checked and repaired immediately at a qualified specialist workshop.

or

▶ If driving safety is impaired while continuing your journey, pull over and stop the vehicle immediately in accordance with the traffic conditions, and contact a qualified specialist workshop.

- if the products are not used correctly and in accordance with the Operating Instructions
- if the checks to be performed regularly are not carried out.

Relevant EU Directives: EC Machinery Directive 2006/42/EC

Applicable standards: ISO 11530

Quality assurance: DIN EN ISO 9001:2000

Güglingen, 01/07/2013

Signed by

Manager, WEBER-HYDRAULIK GmbH

Representative for technical documentation,  
WEBER-HYDRAULIK GMBH

Heilbronner Straße 30, 74363 Güglingen

### **Mechanical jack declaration of conformity**

Copy and translation of the original declaration of conformity:

#### **EC declaration of conformity**

1.

The signatory, as a representative

Manufacturer:

BRANO a.s.

74741 Hradec nad Moravicí, Opavská 1000,

Czech Republic

ID no.: 64-387-5933

VAT ID no.: CZ64-387-5933

hereby declare under our sole responsibility that the product:

2. a)

Description:

Jack

Type, number:

A 910 580 00 00

Year of manufacture: 2017

Fulfils all relevant conditions

Directive no. 2006/42/EC

b)

Description and intended use:

The jack is intended only for raising the specified vehicle according to the instructions affixed to the jack.

Technical documentation for the product is held by the manufacturer. Representative for compiling technical documentation: director of the technical department at Brano a.s.

## **Declarations of conformity**

### **Electromagnetic compatibility**

The electromagnetic compatibility of the vehicle components has been checked and certified according to the currently valid version of Regulation UN-R 10.

### **Wireless vehicle components**

The following information is valid for all wireless components in the vehicle as well as the information systems and communication devices integrated in the vehicle:

This vehicle's wireless components meet the basic requirements and other relevant regulations stipulated in guideline 2014/53/EU. Further information is available from any Mercedes-Benz service centre.

## **Jack**

### **Hydraulic jack declaration of conformity**

Copy and translation of the original declaration of conformity:

EC declaration of conformity 2006/42/EC

We, WEBER-HYDRAULIK GMBH, Heilbronner Str. 30, 74363 Güglingen, hereby declare that the product "Weber-Hydraulik hydraulic bottle jack", types:

A AD ADX AH AHX AL AT ATD ATDX ATG ATN  
ATGX ATPX ATQ AX

Capacity: 2,000 to 100,000 kg

Serial no.: from year of manufacture 01/2010

conforms to the relevant basic health and safety requirements of the EC Machinery Directive.

This EC declaration of conformity becomes invalid:

- in the event of modifications or repairs performed by an unqualified person

3.

Hradec nad Moravicí

City

4.

12.07.2017

Date

Signed by:

Director of Quality

### Diagnostics connection

The diagnostics connection is only intended for the connection of diagnostic devices at a qualified specialist workshop.

**⚠ WARNING** Risk of accident due to connecting devices to the diagnostics connection

If you connect equipment to a diagnostics connection in the vehicle, it may affect the operation of vehicle systems.

As a result, the operating safety of the vehicle could be affected.

- ▶ Only connect equipment to a diagnostics connection in the vehicle which is approved for your vehicle by Mercedes-Benz.

**⚠ WARNING** Risk of accident due to objects in the driver's footwell

Objects in the driver's footwell may impede pedal travel or block a depressed pedal.

This jeopardises the operating and road safety of the vehicle.

- ▶ Stow all objects in the vehicle securely so that they cannot get into the driver's footwell.
- ▶ Always fit the floor mats securely and as prescribed in order to ensure that there is always sufficient room for the pedals.
- ▶ Do not use loose floor mats and do not place floor mats on top of one another.

**! NOTE** Battery discharging from using devices connected to the diagnostics connection

Using devices at the diagnostics connection drains the battery.

- ▶ Check the charge level of the battery.
- ▶ If the charge level is low, charge the battery, e.g. by driving a considerable distance.

Connecting equipment to the diagnostics connection can lead to emissions monitoring information being reset, for example. This may lead to the vehicle failing to meet the requirements of the next emissions inspection during the main inspection.

### Notes on changes to the engine output

Output increases can:

- change emission values
- lead to malfunctions
- lead to consequential damage

The operating safety of the engine is not guaranteed in all situations.

If the vehicle's engine output is increased:

- tyres, suspension, brake system and engine cooling system must be adapted to the increase engine output.
- vehicle must be recertified.
- report changes in output to the accident insurance body.

This will otherwise lead to the invalidation of the vehicle's general operating permit and its insurance coverage.

If you sell the vehicle, inform the buyer of any alterations to the vehicle's engine output. If you do not inform the buyer, this may constitute a punishable offence under national legislation.

### Qualified specialist workshop

A qualified specialist workshop has the necessary special skills, tools and qualifications to correctly carry out any necessary work on your vehicle. This particularly applies to safety-relevant works.

Always have the following work on the vehicle carried out at a qualified specialist workshop:

- safety-relevant works
- service and maintenance work
- repair work
- modifications, installations and conversions
- work on electronic component parts

Mercedes-Benz recommends that you use a Mercedes-Benz service centre for this purpose.

### Vehicle registration

Mercedes-Benz may ask its service centres to carry out technical inspections on certain vehicles. The quality or safety of the vehicle is improved as a result of the inspection.

Mercedes-Benz can only inform you about vehicle checks if it has your registration data.

In the following cases your vehicle may not be registered to you yet:

- if your vehicle was not purchased at an authorised specialist dealer.
- if your vehicle has not been inspected at a Mercedes-Benz service centre.

It is advisable to register your vehicle with a Mercedes-Benz service centre.

Inform Mercedes-Benz as soon as possible about any change in address or vehicle ownership. You can do this, for example, at a Mercedes-Benz service centre.

### Correct use of the vehicle

If you remove warning stickers, others may fail to recognise the dangers. Leave warning stickers in position.

Observe the following information when driving your vehicle:

- safety notes in these Owner's Manual
- technical data for the vehicle
- traffic regulations
- laws pertaining to motor vehicles and safety standards

### Implied warranty

**!** **NOTE** Damage to the vehicle arising from violation of these operating instructions.

Damage to the vehicle can arise from violation of these operating instructions.

This damage is not covered either by the Mercedes-Benz implied warranty or by the New- or Used-Vehicle Warranty.

▶ Follow the instructions in these operating instructions on proper operation of

your vehicle as well as on possible vehicle damage.

### QR codes for rescue card

The QR code stickers are affixed to the B-pillar on the driver's and co-driver's side. In the event of an accident, emergency services can use the QR code to quickly determine the corresponding rescue card for your vehicle. The current rescue card contains, in compact form, the most important information about your vehicle e.g. the routing of electric cables.

Further information can be found at <http://www.mercedes-benz.de/qr-code>.

### Data storage

#### Electronic control units

Your vehicle is equipped with electronic control units. Some of them are necessary for your vehicle to function safely, some provide support when driving (driver assistance systems). In addition, your vehicle offers comfort or entertainment functions which are also made possible with electronic control units.

Electronic control units contain data memories which can permanently or temporarily store technical information on vehicle's operating state, component stress, service requirements as well as technical events and faults.

This information generally documents the state of a component part, a module, a system or of the environment such as:

- operating statuses of system components (e.g. fluid levels, battery status, tyre pressure)
- status messages concerning the vehicle or its individual components (e.g. wheel rpm/speed, deceleration, lateral acceleration, indication of whether seat belts are fastened)
- malfunctions or defects in important system components (e.g. lights, brakes)
- information on events in which the vehicle is damaged
- system reactions in special driving situations (e.g. airbag deployment, intervention of stability control systems)
- ambient conditions (e.g. temperature, rain sensor)

In addition to the provision of control unit functions, this data serves to recognise and rectify faults as well as to optimise vehicle functions by the manufacturer. Most of this data is volatile and is only processed in the vehicle itself. Only a small proportion of the data is stored in event or fault memories.

When you use services, the technical data from the vehicle can be read out by service network employees (e.g. workshops, manufacturers) or third parties (e.g. breakdown services). Services include repair services, maintenance processes, warranty events and quality assurance measures, for example. The data are read out via the connection for the diagnostics connection in the vehicle, which is required by law. The respective workshop of ServiceNetwork or third parties collect, process and use the data. The data documents technical states of the vehicle, helps in finding errors and in improving quality and are transferred to the manufacturer if necessary. In addition, the manufacturer is subject to product liability. For this purpose, the manufacturer requires technical data from vehicles.

Fault memories in the vehicle can be reset by a service outlet during repairs or maintenance work.

Depending on the equipment selected, you can enter data in comfort and infotainment functions of the vehicle.

These include, for example:

- multimedia data, such as music, films or photos for playback in an integrated multimedia system
- address book data for use in an integrated hands-free system or an integrated navigation system
- navigation destinations entered
- data on the use of Internet services

This data can be saved locally in the vehicle or located on a device that you have connected to the vehicle (e.g. smartphone, USB memory stick or MP3 player). If this data is saved in the vehicle, you can delete it at any time. Transfer of this data to third parties only occurs on your request, especially as part of online services according to the settings you selected.

You can save convenience settings/individualisation in the vehicle and change them at any time.

Depending on the piece of equipment in question, these can include:

- settings of the seat and steering wheel positions
- suspension and climate control settings
- customisations such as interior lighting

If your vehicle is equipped appropriately, you can connect your smartphone or another mobile end device to the vehicle. You can operate these devices via the control elements integrated in the vehicle. The smartphone's picture and sound can be output via the multimedia system. Simultaneously, specific items of information are transferred to your smartphone.

Depending on the type of integration, this can include:

- general vehicle data
- position data

This enables the use of selected smartphone apps, e.g. navigation or music playback. There is no additional interaction between the smartphone and the vehicle, particularly active access to vehicle data. Which type of further data processing occurs is determined by the provider of the specific app used. Which settings you can make, if any, depends on the specific app and the operating system of your smartphone.

---

## Online services

### Wireless network connection

If your vehicle has a wireless network connection, data can be exchanged between your vehicle and other systems. The wireless network connection is enabled via the vehicle's transmission and reception unit or via connected mobile end devices (e.g. smartphones). Online functions can be used via this wireless network connection. These include online services and applications/apps, which are provided by the manufacturer or by other providers.

### Manufacturer's own services

In the case of the manufacturer's online services, the manufacturer describes the functions in a suitable place (e.g. operating instructions, manufacturer's website) and provides the associated information subject to data protection legislation. Personal identification data may be used to provide online services. The data exchange for this takes place via a secure connection, e.g. with the manufacturer's IT systems intended for the pur-

pose. The collecting, processing, and use of personal identification data beyond the provision of services occurs exclusively on the basis of a legal permit or after due consent.

Generally, you can activate or deactivate the services and functions (partly subject to a fee). In some cases, this also applies to the whole data connection of the vehicle. Excluded from this are special legally prescribed functions and services.

### **Services of third parties**

If it is possible to use online services from other providers, these services are subject to the data protection and terms of use of the responsible provider. The manufacturer has no influence on the contents exchanged whilst using these services.

Please ask the respective service provider for details on the type, extent and purpose of the collection and use of personal data in the context of third party services.

### **Copyright**

Information on licences for free and open-source software used in your vehicle can be found on the data storage medium in your vehicle document wallet and with updates on the following website:  
<http://www.mercedes-benz.com/opensource>.

## Restraint system

### Protection by the restraint system

The restraint system includes the following components:

- Seat belt system
- Airbags
- Child restraint system
- Child seat securing system

The restraint system can reduce the risk of vehicle occupants coming into contact with parts of the vehicle interior in the event of an accident. In the event of an accident, the restraint system can also reduce the forces to which the vehicle occupants are subjected.

A seat belt can only provide the best level of protection if it is worn correctly. Depending on the detected accident situation, seat belt tensioners and/or airbags supplement the protection offered by a correctly worn seat belt. Seat belt tensioners and/or airbags are not deployed in every accident.

Vehicles with a front passenger bench seat: the seat belt tensioner on the front passenger seat is triggered whether or not the seat belt tongue is engaged in the seat belt buckle.

If the vehicle does not have a driver's airbag, the seat belt system does not include a seat belt tensioner or a seat belt force limiter.

In order for the restraint system to provide the intended level of protection, each vehicle occupant must observe the following information:

- Fasten seat belts correctly.
- Sit in an almost upright seat position with their back against the seat backrest.
- Sit with their feet resting on the floor, if possible.
- Always secure persons under 1.50 m tall in an additional restraint system suitable for Mercedes-Benz vehicles.

However, no system available today can completely eliminate injuries and fatalities in every accident situation. In particular, the seat belt and airbag generally do not protect against objects penetrating the vehicle from the outside. It is also not possible to completely rule out the risk of injury caused by the airbag deploying.

### Reduced restraint system protection

**⚠ WARNING** Risk of injury or death from modifications to the restraint system

The restraint system can no longer function correctly after alterations have been made.

The restraint system may then not protect the vehicle occupants as intended by failing in an accident or triggering unexpectedly, for example

- ▶ Never alter the parts of the restraint system.
- ▶ Never tamper with the wiring or any electronic component parts or their software.

If it is necessary to modify the vehicle to accommodate a person with disabilities, contact a qualified specialist workshop.



Mercedes-Benz recommends that you use driving aids which have been approved for your vehicle by Mercedes-Benz.

### Restraint system functionality

When the ignition is switched on, a self-test is performed, during which the  restraint system warning lamp lights up. It goes out no later than a few seconds after the vehicle is started. The components of the restraint system are then functional.

### Restraint system malfunction

A malfunction has occurred in the restraint system in the following cases:

- The  restraint system warning lamp does not light up when the ignition is switched on.
- The  restraint system warning lamp lights up continuously or repeatedly during a journey.

**⚠ WARNING** Risk of injury or fatal injury due to a malfunction in the restraint system

If the restraint system is malfunctioning, restraint system components may be triggered unintentionally or might not be triggered at all in the event of an accident. This may affect the seat belt tensioner or airbag, for example.



▶ Have the restraint system checked and repaired immediately at a qualified specialist workshop.

### Function of the restraint system in an accident

How the restraint system works is determined by the severity of the impact detected and the type of accident anticipated:

- frontal impact
- rear impact
- side impact

The activation thresholds for the components of the restraint system are determined based on the evaluation of the sensor values measured at various points in the vehicle. This process is pre-emptive in nature. The triggering/deployment of the components of the restraint system should take place in good time at the start of the collision.

Factors which can only be seen and measured after a collision has occurred cannot play a decisive role in airbag deployment. Nor do they provide an indication of airbag deployment.

The vehicle may be deformed significantly without an airbag being deployed. This is the case if only parts which are relatively easily deformed are affected and the rate of vehicle deceleration is not high. Conversely, an airbag may be deployed even though the vehicle suffers only minor deformation. If very rigid vehicle parts such as longitudinal members are hit, for example, the vehicle deceleration may be high enough for this to happen.

**The components of the restraint system can be activated or deployed independently of each other:**

Component	Detected deployment situation
Seat belt tensioners	Frontal impact, rear impact, side impact <sup>1)</sup>
Driver's airbag, front passenger front airbag	Frontal impact
Side impact airbag	Side impact
Window airbag	Side impact, frontal impact

<sup>1)</sup> Only if the vehicle is equipped with a side impact airbag or windowbag.

**⚠ WARNING** Risk of burns from hot airbag components

The airbag parts are hot after an airbag has been deployed.

- ▶ Do not touch the airbag parts.
- ▶ Have a deployed airbag replaced at a qualified specialist workshop as soon as possible.

Mercedes-Benz recommends that you have the vehicle towed to a qualified specialist workshop after an accident. Take this into account, particularly if a seat belt tensioner was triggered or an airbag was deployed.

If the seat belt tensioners are triggered or an airbag is deployed, you will hear a bang, and a small amount of powder may also be released:

- The bang will not generally affect your hearing.
- In general, the powder released is not hazardous to health but may cause short-term breathing difficulties to persons suffering from asthma or other pulmonary conditions. Provided it is safe to do so, leave the vehicle immediately or open the window in order to prevent breathing difficulties.

### Seat belts

#### Protection provided by the seat belt

Always fasten your seat belt correctly before starting a journey. A seat belt can only provide the best level of protection if it is worn correctly.

**⚠ WARNING** Risk of injury or death due to incorrectly fastened seat belt

If the seat belt is not worn correctly, it cannot perform its intended protective function.

In addition, an incorrectly fastened seat belt can also cause injuries, for example, in the event of an accident or when braking or changing direction suddenly.

- ▶ Always ensure that all vehicle occupants have their seat belts fastened correctly and are sitting properly.

Always observe the instructions about the correct driver's seat position and adjusting the seat (→ page 60).

In order for the correctly worn seat belt to provide the intended level of protection, each vehicle occupant must observe the following information:

- The seat belt must not be twisted and must fit tightly and snugly across the body.
- The seat belt must be routed across the centre of the shoulder and as low down across the hips as possible.
- The shoulder section of the seat belt should not touch your neck nor be routed under your arm or behind your back.
- Avoid wearing bulky clothing, e.g. a winter coat.
- Push the lap belt down as far as possible across your hips and pull tight with the shoulder section of the belt. Never route the lap belt across your abdomen.
- Never route the seat belt across sharp, pointed, abrasive or fragile objects.
- Only one person should use each seat belt at any one time. Never allow babies and children to travel sitting on the lap of another vehicle occupant.
- Never secure objects with a seat belt if the seat belt is also being used by one of the vehicle's occupants. Always observe the instructions for loading the vehicle when securing objects, luggage or loads (→ page 73).

Also ensure that no objects, e.g. a cushion, are ever placed between a person and the seat.

If children are travelling in the vehicle, be sure to observe the instructions and safety notes on "Children in the vehicle" (→ page 32).

### Reduced seat belt protection

**⚠ WARNING** Risk of injury or death due to incorrect seat position

The seat belt does not offer the intended level of protection if you have not moved the seat backrest to an almost vertical position.

When braking or in the event of an accident, you could slide underneath the seat belt and sustain abdominal or neck injuries, for example.

- ▶ Adjust the seat properly before beginning your journey.
- ▶ Always ensure that the seat backrest is in an almost vertical position and that the shoulder section of your seat belt is routed across the centre of your shoulder.

**⚠ WARNING** Risk of injury or death when additional restraint systems are not used for persons with a smaller build

Persons under 1.50 m tall cannot wear the seat belt correctly without a suitable additional restraint system.

If the seat belt is not worn correctly, it cannot perform its intended protective function. In addition, an incorrectly fastened seat belt can also cause injuries, for example, in the event of an accident or when braking or changing direction suddenly.

- ▶ Always secure persons under 1.50 m tall in a suitable restraint system.

**⚠ WARNING** Risk of injury or death due to damaged or modified seat belts

Seat belts cannot provide protection in the following situations:

- If the seat belts are damaged, modified, extremely dirty, bleached or dyed
- If the seat belt buckle is damaged or extremely dirty
- If the seat belt tensioners, seat belt anchorages or seat belt retractors have been modified

Seat belts may be damaged in an accident, although the damage may not be visible, e.g. due to splinters of glass.

Modified or damaged seat belts may tear or fail, e.g. in an accident.

Modified seat belt tensioners could accidentally trigger or fail to function as intended.

- ▶ Never modify the seat belts, seat belt tensioners, seat belt anchorages or seat belt retractors.
- ▶ Make sure that the seat belts are undamaged, not worn and clean.
- ▶ Always have the seat belts checked immediately after an accident at a qualified specialist workshop.

Mercedes-Benz recommends that you use seat belts which have been approved for your vehicle by Mercedes-Benz.

**⚠ WARNING** Risk of injury or death from deployed pyrotechnic seat belt tensioners

Pyrotechnic seat belt tensioners that have been deployed are no longer operational and are unable to perform their intended protective function.

► Therefore, have deployed pyrotechnic seat belt tensioners immediately replaced at a qualified specialist workshop.

Mercedes-Benz recommends that you have the vehicle towed to a qualified specialist workshop after an accident.

**! NOTE** Damage caused by trapping the seat belt

If an unused seat belt is not fully retracted, it may become trapped in the door or in the seat mechanism.

► Always ensure that an unused seat belt is fully retracted.

### Fastening and adjusting seat belts

If the seat belt is pulled quickly or sharply, the seat belt retractor locks. The seat belt strap cannot be pulled out any further.



► Always engage seat belt tongue ② of the seat belt into seat belt buckle ① of the corresponding seat.

► Press and hold the seat belt outlet release and slide seat belt outlet ③ into the desired position.

► Let go of the seat belt outlet release and ensure that seat belt outlet ③ locks into position.

### Vehicles with single front passenger seat:

**! NOTE** Deployment of the seat belt tensioner when the front passenger seat is unoccupied

If the seat belt tongue is engaged in the seat belt buckle of the unoccupied front passenger seat, the seat belt tensioner may also deploy in the event of an accident along with other systems.

► Only one person should use each seat belt at any one time.

### Releasing a seat belt

► Press the release button in the seat belt buckle and guide the seat belt back with the seat belt tongue.

### Function of the seat belt warning system for driver and co-driver

The  seat belt warning lamp in the Instrument Display reminds you that all vehicle occupants must fasten their seat belts correctly.

A warning tone may also sound.

The seat belt warning goes out when the driver's seat belt is fastened. Depending on the vehicle's equipment the seat belt warning may go out as soon as the driver's and co-driver seat belts are fastened.

Only for certain countries: depending on whether the driver's seat belt is already fastened, the  seat belt warning lamp comes on for six seconds every time after switching on the ignition. After the engine is started, it goes out as soon as the driver's seat belt is fastened.

## Airbags

### Overview of airbags

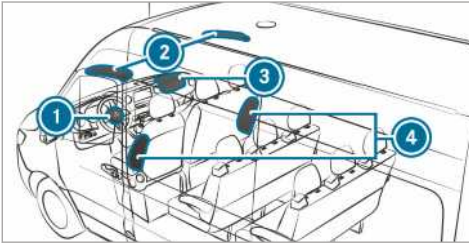

- ① Driver's airbag
- ② Window airbag
- ③ Co-driver front airbag
- ④ Side airbag

An airbag's installation location is identified by the label AIRBAG.

When activated, an airbag can increase protection for the respective vehicle occupant.

#### Potential protection per airbag:

AIRBAG	Potential protection for ...
Driver's airbag, co-driver front airbag:	Head and chest
Window airbag	Head
Side airbag	Chest and pelvis

#### Protection by the airbags

Depending on the accident situation, an airbag may supplement the protection offered by a correctly fastened seat belt.

**⚠ WARNING** Risk of injury or death due to incorrect seat position

If you deviate from the correct seat position, the airbag cannot perform its intended protective function and deployment may even cause further injuries.

To avoid hazardous situations, always make sure that all vehicle occupants:

- Have their seat belt fastened correctly, including pregnant women.

- Are seated properly and keep as far away as possible from the airbags.
- Observe the following information.

▶ Always make sure that there are no objects between the airbag and vehicle occupant.

To avoid the risks resulting from the deployment of an airbag, each vehicle occupant must observe the following information:

- Before starting your journey, adjust your seat correctly; the driver's seat and front passenger seat should be moved as far back as possible.

When doing so, always observe the information on the correct driver's seat position (→ page 60).

- Only hold the steering wheel by the steering wheel rim. This allows the airbag to be fully deployed.
- Always lean against the seat backrest when the vehicle is in motion. Do not lean forwards or against the door or side window. You may otherwise be in the deployment area of the airbags.
- Always keep your feet on the floor. Do not put your feet on the cockpit, for example. Your feet may otherwise be in the deployment area of the airbag.
- If children are travelling in the vehicle, observe the additional notes (→ page 32).
- Always stow and secure objects correctly.

Objects in the vehicle interior may prevent an airbag from functioning correctly. Each vehicle occupant must always make sure of the following:

- There are no people, animals or objects between the vehicle occupants and an airbag.
- There are no objects between the seat, door and door pillar (B-pillar).
- There are no hard objects, e.g. coat hangers, hanging on the grab handles or coat hooks.
- There are no accessory parts, such as cup holders, attached to the vehicle within the deployment area of an airbag, e.g. on doors, side windows or side panelling.
- There are no heavy, sharp-edged or fragile objects in the pockets of your clothing. Store such objects in a suitable place.

## Reduced airbag protection

### **▲ WARNING** Risk of injury from modifications to the airbag cover

If you modify an airbag cover or affix objects such as stickers to it, the airbag can no longer function correctly.

- ▶ Never modify an airbag cover and do not affix objects to it.

The installation location of an airbag is identified by the AIRBAG symbol (→ page 31).

### **▲ WARNING** Risk of injury or death due to the use of unsuitable seat covers

Unsuitable seat covers can obstruct or prevent the deployment of the airbags integrated into the seats.

Consequently, the airbags cannot protect vehicle occupants as they are designed to do.

- ▶ You should only use seat covers that have been approved for the corresponding seats by Mercedes-Benz.

### **▲ WARNING** Risk of injury due to malfunctions of the sensors in the door panelling

Sensors to control the airbags are located in the doors. Modifications or work not performed correctly to the doors or door panelling, as well as damaged doors, can lead to the function of the sensors being impaired. The airbags might therefore not function properly any more.

Consequently, the airbags cannot protect vehicle occupants as they are designed to do.

- ▶ Never modify the doors or parts of the doors.
- ▶ Always have work on the doors or door panelling carried out at a qualified specialist workshop.

### **▲ WARNING** Risk of injury due to deployed airbag

A deployed airbag no longer offers any protection and cannot provide the intended protective function in the event of an accident.

- ▶ Have the vehicle towed to a qualified specialist workshop in order to have the deployed airbag replaced.

Have deployed airbags replaced immediately.

## Children in the vehicle

### Notes on the safe transportation of children

#### **▲ WARNING** Risk of accident and injury due to children left unattended in the vehicle

If you leave children unattended in the vehicle, they may be able to set the vehicle in motion, for example by:

- releasing the parking brake.
- shifting the automatic transmission out of park position [P] or shifting manual transmission into idle position.
- starting the engine.

In addition, they may operate vehicle equipment and become trapped.

- ▶ Never leave children unattended in the vehicle.
- ▶ When leaving the vehicle, always take the key with you and lock the vehicle.

#### **▲ WARNING** Risk of fatal injury due to exposure to extreme heat or cold in the vehicle

If people – particularly children – are exposed to extreme temperatures over an extended period of time, there is a risk of serious or even fatal injury!

- ▶ Never leave anyone – particularly children – unattended in the vehicle.
- ▶ Never leave animals in the vehicle unattended.

#### **▲ WARNING** Risk of burns when the child seat is exposed to direct sunlight

If the child restraint system is exposed to direct sunlight or heat, parts could heat up.

Children could suffer burns on these parts, particularly on metallic parts of the child restraint system.

- ▶ Always make sure that the child restraint system is not exposed to direct sunlight.
- ▶ Protect it with a blanket, for example.

- ▶ If the child restraint system has been exposed to direct sunlight, allow it to cool before securing a child into it.
- ▶ Never leave children unattended in the vehicle.

To improve protection for children younger than 12 years old or under 1.50 m in height, Mercedes-Benz recommends you observe the following information:

- Only secure children using a child restraint system which is appropriate to the height, age and weight of the child and recommended and suitable for Mercedes-Benz vehicles. Be sure to observe the instructions for correct use of the child restraint system.
- Always fit a child restraint system to a rear seat if possible.
- Only use the following securing systems for child restraint systems:
  - the seat belt system
  - the ISOFIX mounting brackets
  - the Top Tether anchorages
- Follow the manufacturer's installation instructions for the child restraint system.
- Observe the warning labels in the vehicle interior and on the child restraint system.

**⚠ WARNING** Risk of injury or death caused by incorrect installation of the child restraint system

If the child restraint system is incorrectly installed on a suitable seating position, it cannot perform its intended protective function.

The child cannot be restrained in the event of an accident, heavy braking or a sudden change of direction.

- ▶ Always comply with the manufacturer's installation instructions for the child restraint system and its correct use.
- ▶ Make sure that the entire base of the child restraint system always rests on the sitting surface of the seat.
- ▶ Never place objects under or behind the child restraint system, e.g. cushions.
- ▶ Always use child restraint systems with the original cover designed for them.
- ▶ Always replace damaged covers with genuine covers.

**⚠ WARNING** Risk of injury or death from unsecured child restraint systems in the vehicle

If the child restraint system is not correctly installed or secured, it could release in the event of an accident, sudden braking or a sudden change in direction.

The child restraint system could be flung around and hit vehicle occupants.

- ▶ Always fit child restraint systems correctly, even when not in use.
- ▶ Always comply with the child restraint system manufacturer's installation instructions.

**⚠ WARNING** Risk of injury or death caused by the use of damaged child restraint systems

Child restraint systems or their retaining systems that have been subjected to a load in an accident may then not be able to perform their intended protective function.

The child cannot be restrained in the event of an accident, heavy braking or a sudden change of direction.

- ▶ Always replace child restraint systems immediately that have been damaged or involved in an accident.
- ▶ Have the securing systems for the child restraint systems checked at a qualified specialist workshop before installing a child restraint system again.

- ① Use Mercedes-Benz care products recommended by Mercedes-Benz to clean child restraint systems. Further information can be obtained at a qualified specialist workshop.

The following notes must be observed:

- When installing a child restraint system on the front passenger seat, the information on installing a child restraint system on the front passenger seat (→ page 36).
- Notes on attaching suitable child restraint systems (→ page 36)
- Notes on recommended child restraint systems (→ page 39).
- Safety notes on the seat belt (→ page 28).
- Information on the correct use of the seat belt (→ page 30).

## Fitting the ISOFIX child restraint system on the rear seat

### Notes on ISOFIX child seat securing systems

**⚠ WARNING** Risk of injury or death if the permissible gross mass of the child and child restraint system together is exceeded

For ISOFIX child restraint systems in which the child is secured using the integrated seat belt integrated in the child restraint system, the permissible gross mass of the child and child restraint system is 33 kg.

If the child and the child restraint system together weigh more than 33 kg, the ISOFIX child restraint system with integrated seat belt does not offer sufficient protection. An excessive load may be placed on the ISOFIX child seat attachments and the child may not be restrained in the event of an accident, for example.

- ▶ If the child and the child restraint system together weigh more than 33 kg, only use an ISOFIX child restraint system which secures the child with the vehicle seat belt.
- ▶ Also secure the child restraint system with the Top Tether belt, if available.

Always comply with the information about the mass of the child restraint system:

- in the manufacturer's installation and operating instructions for the child restraint system used
- on a label on the child restraint system, if present

Regularly check that the permissible gross mass of the child and child restraint system is still complied with.

When using a child restraint system, be sure to observe the manufacturer's installation and operating instructions as well as its correct use and the suitability of the seats for attaching a child restraint system.

ISOFIX is a standardised securing system for specially designed restraint systems. ISOFIX child restraint systems are approved in accordance with UN-R44.

Only child restraint systems that have been approved in accordance with UN-R44 may be attached to ISOFIX mounting brackets.



Symbol for fitting an ISOFIX child restraint system

### Fitting ISOFIX child seat securing systems

**⚠ WARNING** Risk of injury or death if the permissible gross mass of the child and child restraint system together is exceeded

For ISOFIX child restraint systems in which the child is secured using the integrated seat belt integrated in the child restraint system, the permissible gross mass of the child and child restraint system is 33 kg.

If the child and the child restraint system together weigh more than 33 kg, the ISOFIX child restraint system with integrated seat belt does not offer sufficient protection. An excessive load may be placed on the ISOFIX child seat attachments and the child may not be restrained in the event of an accident, for example.

- ▶ If the child and the child restraint system together weigh more than 33 kg, only use an ISOFIX child restraint system which secures the child with the vehicle seat belt.
- ▶ Also secure the child restraint system with the Top Tether belt, if available.

Always comply with the information about the mass of the child restraint system:

- in the manufacturer's installation and operating instructions for the child restraint system used
- on a label on the child restraint system, if available



Check regularly that the permissible gross mass of the child plus the child restraint system is not exceeded.

When fitting a child restraint system, be sure to observe the manufacturer's installation and operating instructions as well as the correct use of the child restraint system and the suitability of the seats.

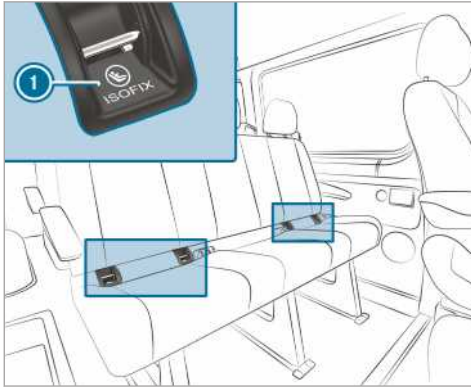

### ① ISOFIX mounting brackets

Before every trip, make sure that the ISOFIX child restraint system is engaged correctly in both ISOFIX mounting brackets in the vehicle.

**!** **NOTE** Damage to the seat belt for the centre seat

When fitting a child restraint system, the seat belt for the centre seat could be damaged.

▶ Make sure that the seat belt is not trapped.

▶ Install the ISOFIX child restraint system on both of the vehicle's mounting brackets.

## Securing Top Tether

**!** **WARNING** Risk of injury due to incorrect attachment of the Top Tether belt

If you attach the Top Tether belt incorrectly, e.g. on an eyelet in the load compartment, the child restraint system will not have been secured correctly.

In an accident, it will therefore be unable to provide the intended level of protection.

▶ Only ever attach the Top Tether hook to the designated Top Tether anchorage.

The risk of injury can be reduced by Top Tether. The Top Tether belt facilitates an additional connection between the child restraint system attached with ISOFIX and the vehicle.

The child restraint system must be equipped with a Top Tether belt.

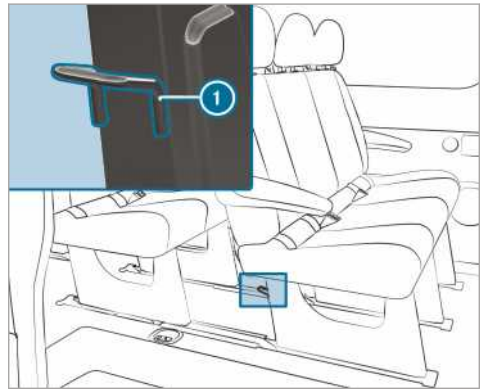

The Top Tether anchorages ① are located on the back of the rear bench seat on the bench seat legs.

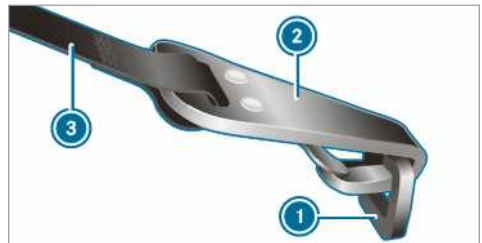

- ▶ If necessary, move the head restraint upwards (→ page 71).
- ▶ Fit the ISOFIX child restraint system with Top Tether. Always comply with the child restraint system manufacturer's installation instructions when doing so.
- ▶ Guide Top Tether belt ③ under the head restraint between the two head restraint bars.
- ▶ Hook Top Tether hook ② without twisting into Top Tether anchorage ①.
- ▶ Tension Top Tether belt ③. Always comply with the child restraint system manufacturer's installation instructions when doing so.



- ▶ If necessary, slide the head restraint downwards (→ page 71). Make sure that you do not interfere with the correct routing of Top Tether belt ③.

### Child restraint systems on the co-driver seat

#### Notes on a child restraint system on the co-driver seat

Accident statistics show that children secured on the rear seats are safer than children secured on the front seats. For this reason, Mercedes-Benz strongly advises that you fit a child restraint system on a rear seat.



Warning notice on the co-driver sun visor

NEVER use a rearward facing child restraint on a seat protected by an ACTIVE AIRBAG in front of it, DEATH or SERIOUS INJURY to the CHILD may occur.

Be sure to also observe the notes on how to safely travel with children (→ page 32).

#### Notes for rearward-facing child restraint systems



The sticker is visible when the co-driver door is open:

The co-driver front airbag cannot be disabled. This is indicated by a special sticker on the co-driver side of the cockpit. Always fit a rearward-facing child restraint system on a suitable rear seat, but never on the co-driver seat.

#### Information for forward-facing child restraint systems on the co-driver seat

When using the child restraint system on the co-driver seat, you must observe the following points:

- Set the co-driver seat to its rearmost position. If on a seat with seat height adjustment, also set the seat to its highest position.
- Set the seat backrest to an almost vertical position.
- Retract the seat cushion length completely.
- The base of the child restraint system must lie fully on the co-driver seat cushion.
- The backrest of a forward-facing child restraint system must, as far as possible, lie flat against the backrest of the co-driver seat. The child restraint system must not touch the roof or be put under strain by the head restraints.
- If necessary, adjust the angle of the seat backrest and the position of the head restraints accordingly.
- Set the seat cushion angle in such a way that the front edge of the seat cushion is in the highest position and the rear edge of the seat cushion is in the lowest position.
- Always make sure that the shoulder belt strap is correctly routed from the seat belt outlet of the vehicle to the shoulder belt guide on the child restraint system. The shoulder belt strap must be routed forwards and downwards from the seat belt outlet.
- If necessary, adjust the seat belt outlet and the co-driver seat as appropriate.
- Never place objects under or behind the child restraint system, e.g. cushions.

Always observe the manufacturer's installation and operating instructions for the child restraint system being used, and the information on fitting suitable child restraint systems (→ page 36).

### Suitability of the seats for child restraint systems

#### Notes on attaching suitable child restraint systems

Only child restraint systems that meet the UNECE standard UN-R44 are permitted for use in the vehicle.

Example of an approval label on child restraint systems:

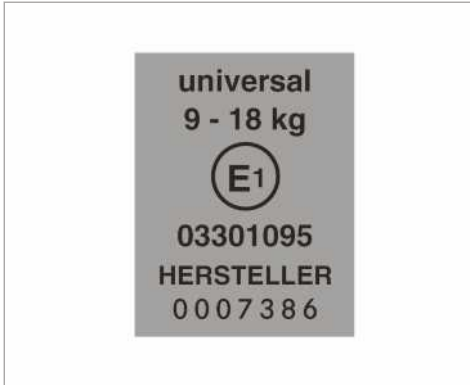

Label for child restraint systems in accordance with UN-R44

ISOFIX child restraint systems of the following "Universal" category can be used in accordance with the tables on suitability of seats for the attachment of child restraint systems on seats labelled U, UF or IUF.

Semi-universal child restraint systems are indicated by the text "semi-universal" on the approval label. They can only be used if the vehicle and the seat are listed in the child restraint system manufacturer's vehicle model list.

#### Notes on the suitability of seats for attaching belt-secured child restraint systems

Observe the following information:

- **When using a baby car seat of the category 0/0+ and a rearward-facing child restraint system on a rear seat:** adjust the

driver's and front passenger seat such that the seat does not touch the child restraint system.

- **When using a forward-facing child restraint system of category I:** the backrest of the child restraint system must, as far as possible, rest flat against the backrest of the seat.
- For certain child restraint systems in weight categories II or III, there may be certain restrictions in the maximum size setting, e.g. due to possible contact with the roof.
- Make sure that the child's feet do not touch the front seat. If necessary, move the front seat forward slightly.
- The child restraint system must not touch the roof or be put under strain by the head restraints. Adjust the head restraints accordingly.
- Observe the manufacturer's installation instructions for the child restraint system.

Legend for the table:

- X Not suitable for children in this weight category.
- U Suitable for child restraint systems of the "Universal" category in this weight category.
- UF Suitable for forward-facing child restraint systems of the "Universal" category in this weight category.
- L Suitable for semi-universal child restraint systems according to the table in "Recommended child restraint systems", or if the vehicle and the seat are listed in the child restraint system manufacturer's vehicle model list.

#### Front passenger seat

Weight category	Front passenger seat (with front passenger front airbag) <sup>1</sup>	Front passenger seat (without front passenger front airbag) <sup>1</sup>	Single seat
<b>Category 0:</b> up to 10 kg	X	U	X
<b>Category 0+:</b> up to 13 kg	X	U	X
<b>Category I:</b> 9 to 18 kg	UF	U	X

Weight category	Front passenger seat (with front passenger front airbag) <sup>1</sup>	Front passenger seat (without front passenger front airbag) <sup>1</sup>	Single seat
<b>Category II:</b> 15 to 25 kg	UF	U	X
<b>Category III:</b> 22 to 36 kg	UF	U	X

<sup>1</sup> Move the front passenger seat to its rearmost and highest position.

### Front passenger bench seat

Weight category	Outer seat (with front passenger front airbag)	Outer seat (without front passenger front airbag)	Centre
<b>Category 0:</b> up to 10 kg	X	U	X
<b>Category 0+:</b> up to 13 kg	X	U	X
<b>Category I:</b> 9 to 18 kg	UF	U	X
<b>Category II:</b> 15 to 25 kg	UF	U	X
<b>Category III:</b> 22 to 36 kg	UF	U	X

### Rear bench seat

Weight category	Rear bench seat (crewcab)	Rear bench seat (Standard/Comfort)
<b>Category 0:</b> up to 10 kg	U	U
<b>Category 0+:</b> up to 13 kg	U	U
<b>Category I:</b> 9 to 18 kg	U	U
<b>Category II:</b> 15 to 25 kg	U	U
<b>Category III:</b> 22 to 36 kg	U	U

## Notes on recommended child restraint systems

### Recommended child restraint systems for attaching with the vehicle seat belt

Weight categories	Manufacturer	Type	Approval number (E1 ...)	Order number (A 000 ...) with colour code 9H95
<b>Category 0:</b> up to 10 kg up to approximately 6 months	Britax Römer	BABY SAFE plus II	04 301 146	970 13 02
<b>Category 0+:</b> up to 13 kg up to approximately 15 months	Britax Römer	BABY SAFE plus II	04 301 146	970 13 02
<b>Category I:</b> 9 to 18 kg between approximately 9 months and 4 years	Britax Römer	DUO plus	04 301 133	970 17 02
<b>Category II/III:</b> 15 to 36 kg between approximately 4 and 12 years	Britax Römer	KIDFIX	04 301 198	970 20 02
	Britax Römer	KIDFIX XP	04 301 304	970 23 02

-  You can obtain further information on the correct child restraint system at any Mercedes-Benz Service Centre.

### Activating/deactivating child safety locks for the doors

 **WARNING** Risk of accident and injury due to children left unattended in the vehicle

If you leave children unattended in the vehicle, they may be able to set the vehicle in motion, for example by:

- releasing the parking brake.
- shifting the automatic transmission out of park position **P** or shifting manual transmission into idle position.
- starting the engine.

In addition, they may operate vehicle equipment and become trapped.

- ▶ Never leave children unattended in the vehicle.

- ▶ When leaving the vehicle, always take the key with you and lock the vehicle.

 **WARNING** Risk of fatal injury due to exposure to extreme heat or cold in the vehicle

If people – particularly children – are exposed to extreme temperatures over an extended period of time, there is a risk of serious or even fatal injury!

- ▶ Never leave anyone – particularly children – unattended in the vehicle.
- ▶ Never leave animals in the vehicle unattended.

 **WARNING** There is a risk of accident and injury if you leave children unattended in the vehicle

If children are travelling in the vehicle, they could:

- open doors, thereby endangering other persons or road users

- get out of the vehicle and be hit by oncoming traffic
- operate vehicle equipment and become trapped, for example
  - ▶ Always activate the child safety locks installed if children are travelling in the vehicle.
  - ▶ Never leave children unattended in the vehicle.
  - ▶ When leaving the vehicle, always take the key with you and lock the vehicle.

The following doors have child safety locks:

- sliding doors
- rear doors on a crewcab

The child safety locks on the doors secure each door separately. The doors can no longer be opened from the inside (exception: electric sliding door). When the vehicle is unlocked, the door can be opened from the outside.

If the electric sliding door is secured, only the sliding door controls in the rear are deactivated. The electric sliding door can be opened at any time using the switch in the centre console (→ page 47).

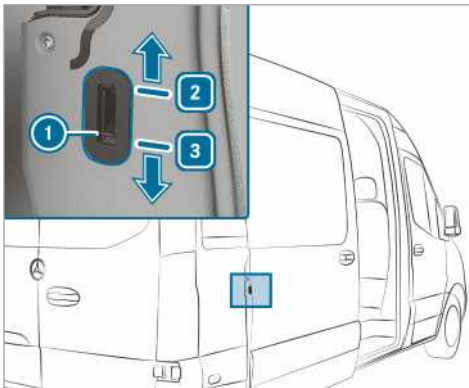

Example: sliding door child safety lock

- ▶ Slide child safety bolt ① to position ② (activate) or ③ (deactivate).
- ▶ Make sure that the child safety locks are working properly.

### Notes on pets in the vehicle

**⚠ WARNING** Risk of accident and injury due to animals left unsecured or unattended in the vehicle

If you leave animals in the vehicle unattended or unsecured, they could possibly press down buttons or switches.

Thereby an animal may:

- activate vehicle equipment and become trapped, for example
- switch systems on or off and endanger other road users

Unsecured animals may be thrown around in the vehicle in the event of an accident or sudden steering and braking manoeuvres and injure vehicle occupants in the process.

- ▶ Never leave animals in the vehicle unattended.
- ▶ Always correctly secure animals while driving, e.g. using a suitable animal carrier.

**Key****Notes on radio connections of the key**

- ⚠ DANGER** Risk of fatal injury to persons with medical devices from the electromagnetic radiation of the start/stop button

Persons with medical devices, e.g. pacemakers or defibrillators:

When you operate the start/stop button, a radio connection is established between the key and the vehicle.

The electromagnetic radiation can affect the functionality of a medical device.

- ▶ Before operating the vehicle, consult your doctor or the manufacturer of the medical device about any possible effects of emissions from such systems.

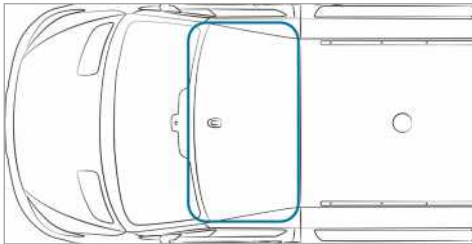
**Detection range of aerial of KEYLESS-START function****Overview of key functions**

- ⚠ WARNING** Risk of accident and injury due to children left unattended in the vehicle

If children are left unattended in the vehicle, they could:

- open doors, thereby endangering other persons or road users.
- get out of the vehicle and be hit by oncoming traffic.
- operate vehicle equipment and become trapped, for example.

In addition, children could also set the vehicle in motion, for example, by:

- releasing the parking brake.

- shifting the automatic transmission out of park position **P** or shifting manual transmission into neutral.
- starting the engine.

- ▶ When leaving the vehicle, always take the key with you and lock the vehicle.
- ▶ Never leave children and animals unattended in the vehicle.
- ▶ Keep the vehicle key out of reach of children.

- ⚠ NOTE** Damage to the key caused by magnetic fields

- ▶ Keep the key away from strong magnetic fields.

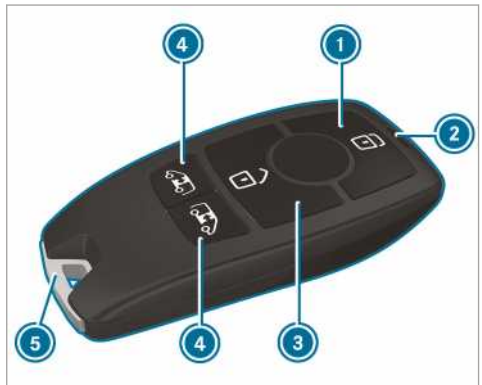

- ① To lock
- ② Battery indicator lamp
- ③ To unlock
- ④ To unlock load compartment (sliding doors and rear doors)/to unlock and open/close electric sliding doors
- ⑤ Emergency key element



The key's factory setting enables you to centrally lock and unlock the following components:

- the driver's and the co-driver door
- the sliding doors
- the rear doors

If you do not open the vehicle within approximately 40 seconds of unlocking:

- the vehicle will lock again
- the anti-theft protection is primed again

Do not keep the key together with electronic devices or metallic objects. This can affect the key's functionality.

- ① If the battery check lamp does not light up when you press the  or  button, the battery is discharged.

Replace the key battery (→ page 42).

### Activating/deactivating the acoustic locking verification signal

Multimedia system:



→  >> Settings >> Vehicle

▶ Activate or deactivate **Acoustic lock**.

### Changing the unlocking settings

Possible unlocking functions of key:

- unlock centrally
- unlock driver's and co-driver door (panel van)
- unlock driver's door (crewbus, chassis version)

▶ **To switch between the settings:** press and hold the  and  buttons at the same time for approximately six seconds until the battery indicator lamp flashes twice.

When the locking function is selected for the driver's door or the driver's and co-driver door:

- pressing the  button a second time unlocks the vehicle centrally

### Reducing the energy consumption of the key

If you do not use the vehicle or a key for an extended period, you may deactivate the KEYLESS START function of the key.

▶ **To deactivate:** press the  button on the key twice in quick succession. The battery indicator lamp on the key lights up twice quickly and once for longer.

▶ **To activate:** press any button on the key.

When starting the vehicle with the key in the slot in the shift console, the key functions are activated automatically.

### Removing/inserting the emergency key element

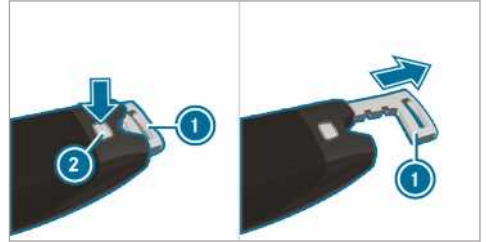

- ▶ **To remove:** press release button ②. Emergency key element ① is pushed slightly out.
- ▶ Pull emergency key element ① out completely.
- ▶ **To insert:** press release button ②.
- ▶ Slide emergency key element ① in completely until it engages.

### Replacing the key battery

**⚠ DANGER** Serious damage to health caused by swallowing batteries

Batteries contain toxic and corrosive substances. Swallowing batteries may cause serious damage to health.

There is a risk of fatal injury.

- ▶ Keep batteries out of the reach of children.
- ▶ If batteries are swallowed, seek medical attention immediately.

**🌿 ENVIRONMENTAL NOTE** Environmental damage due to improper disposal of batteries



Batteries contain pollutants. It is illegal to dispose of them with the household rubbish.



Dispose of batteries in an environmentally responsible manner. Take discharged batteries to a qualified

specialist workshop or to a collection point for used batteries.

#### Requirements:

- You require a CR2 032 3 V cell battery.

Mercedes-Benz recommends that you have the battery replaced by a qualified specialist workshop.

- Remove the emergency key (→ page 42).



Example image

- Press release button (2) down fully and slide cover (1) forward.
- Remove battery compartment (3) and remove the discharged battery.
- Insert the new battery into battery compartment (3). Observe the positive pole marking in the battery compartment and on the battery.
- Insert battery compartment (3).
- Replace cover (1) so that it engages.
- Slide the emergency key element in completely until it engages (→ page 42).

#### Problems with the key

Problem	Possible causes/consequences and ► Solutions
You cannot lock or unlock the vehicle any more.	<p>Possible causes:</p> <ul style="list-style-type: none"> <li>the key battery is weak or discharged</li> <li>there is interference from a powerful source of radio waves</li> <li>the key is faulty</li> </ul> <p>► Check the battery using the battery check lamp and replace if necessary (→ page 42).</p> <p>► Use the emergency key element to unlock and lock the vehicle (→ page 42).</p> <p>► Have the key checked at a qualified specialist workshop.</p>
You have lost a key.	<p>► Have the key deactivated at a qualified specialist workshop.</p> <p>► If necessary, have the mechanical locks replaced.</p>

#### Doors

##### Notes on the additional door lock

The additional door lock is only available for vehicles for the United Kingdom.

**⚠ WARNING** Risk of injury to persons inside the vehicle when the additional door lock is activated

If the additional door lock is activated, the doors can no longer be opened from the inside.

If there are persons in the vehicle, they can no longer leave the vehicle, e.g. in hazardous situations.



- ▶ Never leave persons unattended in the vehicle, particularly children, elderly persons or persons in need of help.
- ▶ If there are persons in the vehicle, do not activate the additional door lock.

The additional door lock is automatically activated:

- after the vehicle has been locked with the key

You can deactivate the additional door lock by deactivating the interior motion sensor (→ page 59).

- ⓘ The additional door lock is inoperative on vehicles without an interior motion sensor.

### Unlocking and opening the door from inside

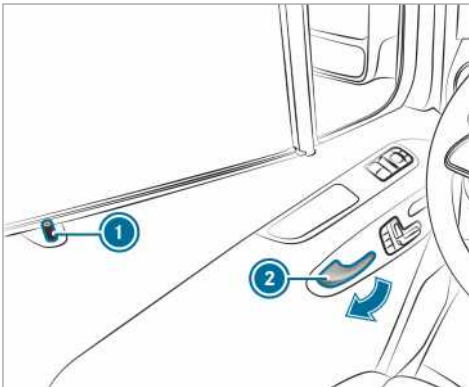

**United Kingdom only:** observe the notes on the additional door lock (→ page 43).

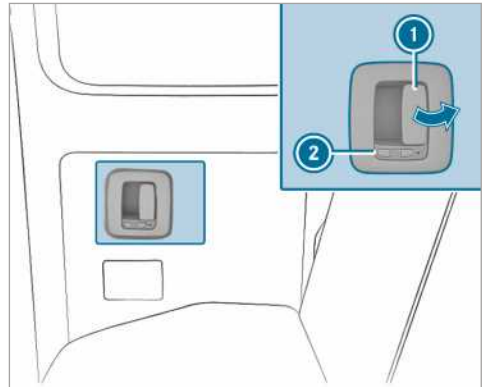

- ▶ **To unlock and open the front door:** pull door handle ②. Locking pin ① pops up when the door is unlocked.
- ▶ Open the door.



The  symbol indicates that the rear door is unlocked.

- ▶ **To unlock and open the rear door:** pull opening lever ① and open the rear door. When the door unlocks, latch ② moves forward. The  symbol is visible.
- ▶ **To close:** pull the rear door closed by the door handle
- ▶ **To lock:** slide latch ② down. The  symbol is visible.

### Locking the door centrally from inside

**⚠ WARNING** Risk of accident and injury due to children left unattended in the vehicle

If children are left unattended in the vehicle, they could:

- open doors, thereby endangering other persons or road users.
- get out of the vehicle and be hit by oncoming traffic.
- operate vehicle equipment and become trapped, for example.

In addition, children could also set the vehicle in motion, for example, by:

- releasing the parking brake.
- shifting the automatic transmission out of park position **P** or shifting manual transmission into neutral.
- starting the engine.

- ▶ When leaving the vehicle, always take the key with you and lock the vehicle.
- ▶ Never leave children and animals unattended in the vehicle.
- ▶ Keep the vehicle key out of reach of children.

**⚠ WARNING** Risk of fatal injury due to exposure to extreme heat or cold in the vehicle

If people – particularly children – are exposed to extreme temperatures over an extended period of time, there is a risk of serious or even fatal injury!

- ▶ Never leave anyone – particularly children – unattended in the vehicle.
- ▶ Never leave animals in the vehicle unattended.

### Locking and unlocking manually

You can use the central locking buttons to centrally lock and unlock the entire vehicle from the inside.

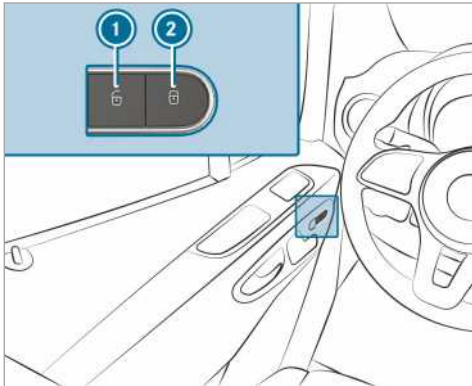

- ▶ **To lock/unlock the entire vehicle:** press button ① (unlock) or ② (lock) when the doors are closed.

### Switching automatic locking feature on/off

When the ignition is switched on and the vehicle is driving at a speed above 15 km/h, the vehicle locks automatically.

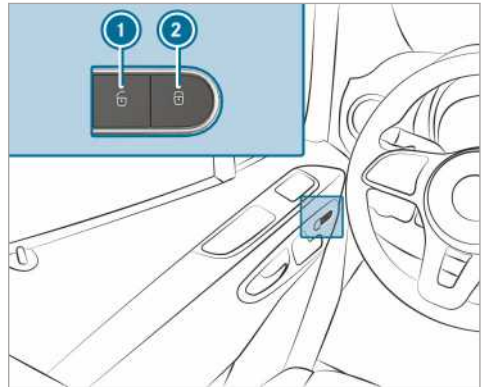

There is a danger of being locked out when the function is activated:

- when tow-starting or pushing the vehicle
- on the roller dynamometer

- ▶ When the doors are closed, switch on the power supply or ignition.
- ▶ **To switch on:** press and hold button ② for approximately five seconds. An acoustic signal sounds.
- ▶ **To switch off:** press and hold button ① for approximately five seconds. An acoustic signal sounds.

### Unlocking/locking the driver's door with the emergency key element

- ① If you want to lock the vehicle completely with the emergency key element, press the button for the locking mechanism from inside first with the driver's door open. Then lock the driver's door with the emergency key element.

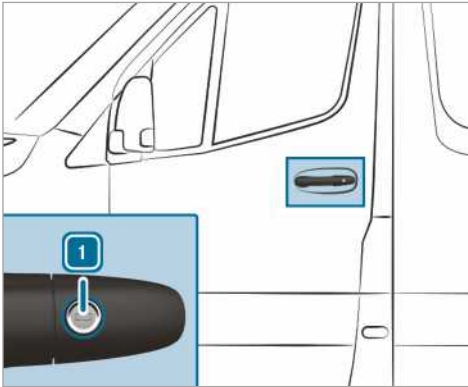

- ▶ **To unlock:** turn the emergency key element left to position 1.
- ▶ **To lock:** turn the emergency key element right to position 1.
- ⓘ **Right-hand drive vehicles:** turn the emergency key in the opposite direction in each case.

### Sliding door

#### Opening/closing the sliding door from outside

**⚠ WARNING** Risk of entrapment by open sliding door which is not engaged

If the open sliding door is not engaged, it could move on its own if the vehicle is on a slope.

This could trap you or other persons.

- ▶ Always make sure that the open sliding door is engaged. Open the sliding door as far as it will go.

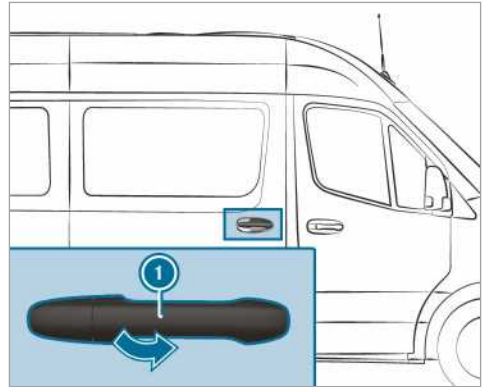

- ⓘ Your vehicle may be equipped with a long sliding door with an intermediate detent. You can also lock the sliding door in place around halfway when opening and closing. If you do this, the door does not have to be opened fully when getting into or out of the vehicle. The sliding door is not fully engaged when in the intermediate detent.

- ▶ **To open:** pull door handle 1. The sliding door opens.
- ▶ Push back the sliding door using door handle 1 until it engages.
- ▶ Check the sliding door detent.
- ▶ **To close:** pull the sliding door by handle 1 and firmly slide it forwards until it closes.

#### Opening/closing the sliding door from inside

**⚠ WARNING** Risk of entrapment by open sliding door which is not engaged

When you open the sliding door, the sliding door could hit other people as it moves backwards.

- ▶ Only open the sliding door when traffic conditions permit.

#### Requirements:

- the child safety lock is deactivated

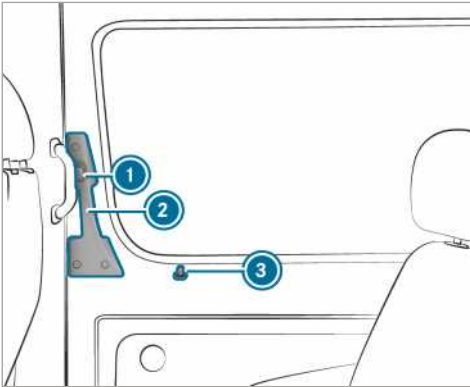

Locking pin ③ pops up when you open a locked door. All doors are unlocked.

- ① Your vehicle may be equipped with a long sliding door with an intermediate detent. You can also lock the sliding door in place around halfway when opening and closing. If you do this, the door does not have to be opened fully when getting into or out of the vehicle. The sliding door is not fully engaged when in the intermediate detent.

- ▶ **To open:** press button ①.
- ▶ Slide the sliding door by handle ② back to the stop.
- ▶ Check the sliding door detent. The sliding door must be engaged.
- ▶ **To close:** press button ①.
- ▶ Slide the sliding door firmly forwards by handle ② until it closes.

### Notes on electrical closing assist

If your vehicle is fitted with electrical closing assist, you will require less force to close the sliding door.

## Electrical sliding door

### Function of the electric sliding door

Your vehicle can be equipped with an electric sliding door on the left and/or right-hand side. The electric sliding door is operated using the following:

- the sliding door buttons on the centre console

- the sliding door button on the door sill (B-pillar)
- the door handle (inside or outside)
- the key

If the electric sliding door is obstructed while opening, it moves a few centimetres in the opposite direction and stops.

If the sliding door is obstructed during the closing procedure, it opens fully again.

If the electric motor of the sliding door is in danger of overheating, e.g. due to frequent opening and closing within a short period, the sliding door opens fully. The sliding door is then locked in place. The sliding door is operational again after approximately 30 seconds.

If there has been a malfunction or if the battery has been disconnected, you can use the release catch to disconnect the sliding door from the electric motor. Then you can open or close the door manually (→ page 48).

### Opening/closing the electric sliding door with the button

**⚠ WARNING** Risk of entrapment by open sliding door which is not engaged

When you open the sliding door, the sliding door could hit other people as it moves backwards.

- ▶ Only open the sliding door when traffic conditions permit.

**⚠ WARNING** Risk of injury despite obstacle detection

Obstacle detection does not react to soft, light and thin objects, such as small fingers. These or other parts of the body could be pressed against the door frame, for instance. Obstacle detection cannot prevent entrapment in these instances.

- ▶ When opening and closing the electric sliding door, make sure that nobody is within the operating range of the sliding door.
- ▶ If someone becomes trapped, press the button again to stop the sliding door.

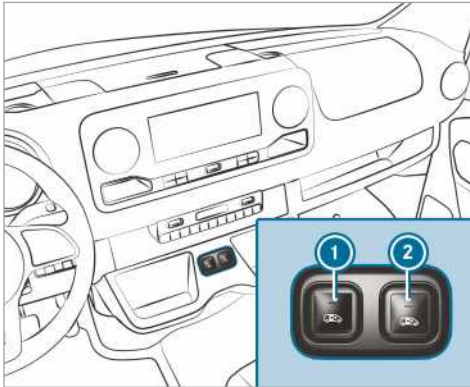

Sliding door buttons on the centre console

- ➊ Opens and closes the sliding door on the left side of the vehicle
- ➋ Opens and closes the sliding door on the right side of the vehicle



Sliding door button on the door sill (B-pillar)

On vehicles with a partition, button ➋ is located on the partition next to the doorway at the level of the inside door handle.

You can only open the sliding door with button ➋ if the child safety lock is not activated.

- ▶ **To open:** briefly press button ➊, ➋ or button ➌.  
The sliding door opens automatically.  
When you open the door using buttons ➊ or ➋, you will additionally hear two warning signals.  
The indicator lamp at the top of button ➊ or ➋ will flash and button ➌ will flash.  
When the sliding door is completely open, the indicator lamp at the top of button ➊ or ➋ will light up.
- ▶ **To close:** briefly press button ➊, ➋ or button ➌.  
The sliding door closes automatically.

When you close the door using buttons ➊ or ➋, you will additionally hear two warning signals.









The indicator lamp at the top of button ➊ or ➋ will flash and button ➌ will flash.

When the sliding door is completely closed, the indicator lamp at the top of button ➊ or ➋ will go out.

- ▶ **To stop automatic operation:** briefly press button ➊ or ➋.  
The sliding door stops moving.

- ⓘ When you stop automatic operation upon opening the door, the door closes when you press the button again.
- ⓘ In unfavourable operating conditions, e.g. frost, ice or heavy soiling, you can press and hold the corresponding button. The electric sliding door moves with increased force. Observe that, in such circumstances, the obstacle detection is less sensitive. To stop the movement, release the button.

### Opening/closing the electric sliding door with the key

- ▶ **To unlock:** briefly press the  or  button on the key.
- ▶ **To open:** press and hold the  or  button on the key for longer than 0.5 seconds.  
You will hear two warning signals and the sliding door will open automatically.
- ▶ **To close:** press and hold the  or  button on the key for longer than 0.5 seconds.  
You will hear two warning signals and the sliding door will close automatically.
- ▶ **To interrupt automatic operation:** briefly press the  or  button on the key.  
The sliding door stops moving.
- ⓘ When you stop automatic operation upon opening the door, the door closes when you press the button again.

### Opening/closing the electric sliding door with the door handle

#### Requirements:

- the child safety lock is deactivated

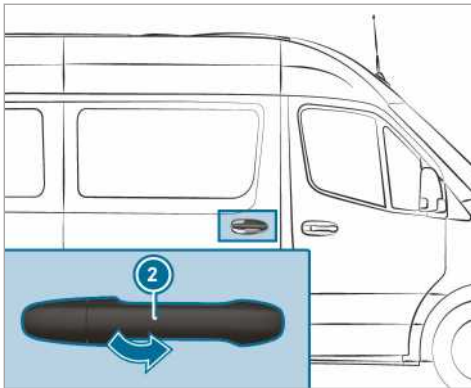
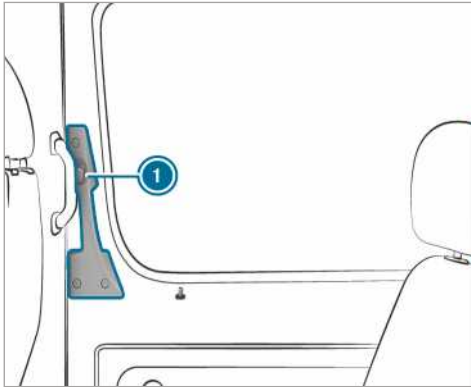

- ▶ Press button ① or pull outside handle ②. The sliding door opens or closes.
- ▶ Press button ① again or pull outside handle ②. The sliding door stops moving.

### Unlocking the electric sliding door manually

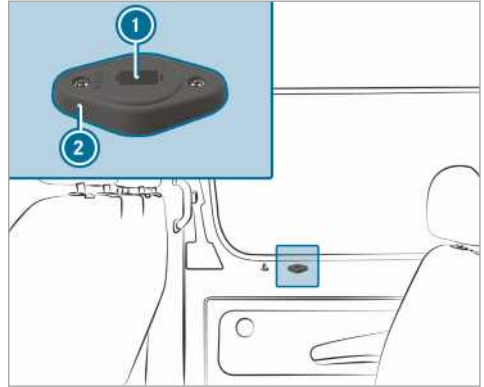

If there has been a malfunction or if the battery has been disconnected, you can use release catch ② to disconnect the sliding door from the electric motor. Then, you can open or close the door manually.

- ▶ **Vehicles with complete sliding door trim:** remove the cover from release catch ②. Service operation is accessible.
- ▶ **To disconnect the sliding door from the electric motor:** insert the key into opening ① of release catch ② into the "AUTO" position.
- ▶ Turn the key 180° clockwise. The "MAN" position is set.
- ▶ Open or close the sliding door with the outside/inside door handle.
- ▶ **To connect the sliding door to the electric motor:** insert the key into opening ① of release catch ② in the "MAN" position.
- ▶ Turn the key 180° anti-clockwise. The "AUTO" position is set.
- ▶ Adjust the sliding door (→ page 50).

**If it is not possible to rectify the malfunction:**

- ▶ Visit a qualified specialist workshop.

## Resetting the electric sliding door

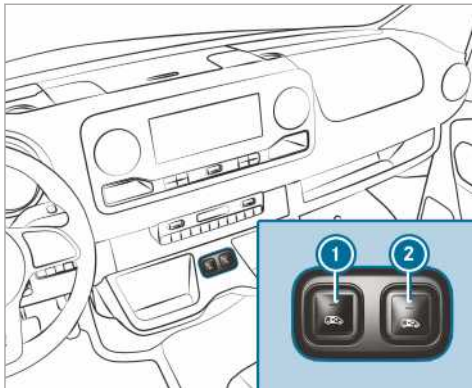

Sliding door buttons on the centre console



Sliding door button on the door sill (B-pillar)

You must reset the sliding door if there has been a malfunction or a voltage supply interruption.

- ▶ If the sliding door is open: press button ① or ② on the centre console or sliding door button ③ on the door sill (B-pillar) and hold until the door is closed.

or

- ▶ Closing the sliding door with the door handle (→ page 48).
  - ▶ Then briefly press button ① or ② on the centre console or sliding door button ③ on the door sill (B-pillar) once, or pull door handle (→ page 48) to completely open the sliding door.
- The sliding door is operational.

## Rear-end doors

### Opening and closing the rear doors from outside

- ⚠ **WARNING** Risk of accident and injury when opening the rear door in poor traffic conditions

When you open a rear door, the following is possible:

- other people or road users may be endangered
- you may be caught by oncoming traffic

This is particularly the case if you open the rear door more than 90°.

- ▶ Only open the rear doors when traffic conditions permit.
- ▶ Always make sure that the rear doors are properly locked.

### Opening the rear right door

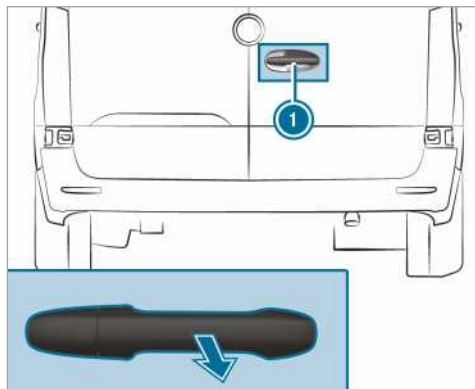

- ▶ Pull handle ①.
- ▶ Swing the rear door to the side until it engages.



## Opening the rear left door

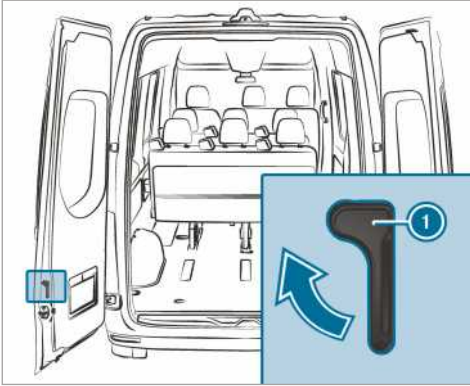

- ▶ Make sure that the rear right door is open and engaged.
- ▶ Pull release handle ① in the direction of the arrow.
- ▶ Swing the rear door to the side until it engages.

## Opening the rear doors fully

- ▶ Open the relevant rear door out past the first detent (90°).
- ▶ Open the rear door fully. The rear door will stay in the stop position.



## Closing the rear doors from outside

- ▶ Close the rear left door firmly from outside.
- ▶ Close the rear right door firmly from outside.

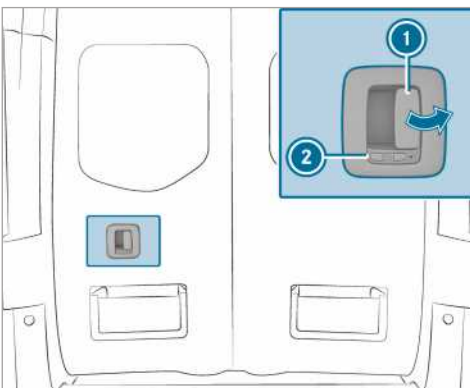
## Opening/closing the rear doors from the inside



The  symbol indicates that the rear door is unlocked.

- ▶ **To unlock:** slide latch ② to the left. The  symbol is visible.
- ▶ **To open:** pull opening lever ① up and open the rear door.
- ▶ Swing the rear door to the side until it engages.
- ▶ **To close:** make sure that the rear left door is closed.
- ▶ Pull the rear right door firmly to by the door handle.
- ▶ **To lock:** slide latch ② to the right. The  symbol is visible.

## Partition sliding door

### Opening and closing the partition sliding door from the driver's compartment

**⚠ WARNING** Risk of becoming trapped due to non-engaged partition sliding door

If the open partition sliding door is not engaged, it can move on its own while the vehicle is in motion.

This can cause you or other people to become trapped.

- ▶ Before driving, always close the partition sliding door and ensure that it is engaged.

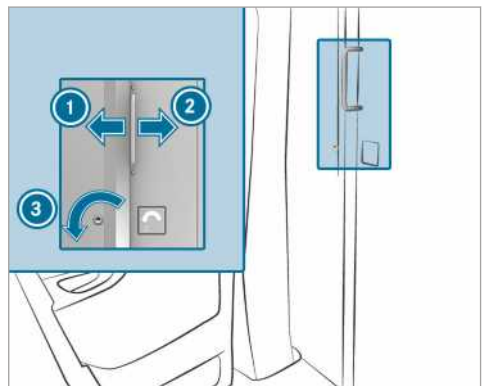

- ▶ **To open:** turn the key to the left ③. The sliding door is unlocked.
- ▶ Slide the sliding door to the right ② as far as it will go.



- ▶ **To close:** slide the sliding door to the left ❶ until it engages.  
You can lock the sliding door with the key.

### Opening and closing the partition sliding door from the load compartment

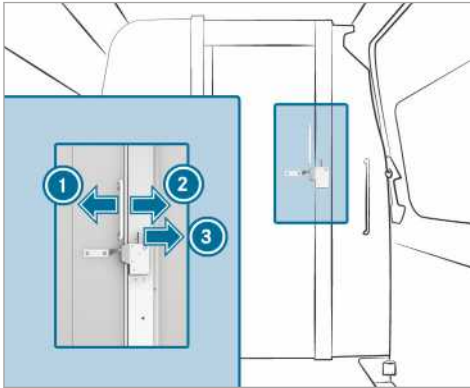

- ▶ **To open:** push the lever to the right ❸.  
The sliding door is unlocked.
- ▶ Slide the sliding door to the left ❶ as far as it will go.
- ▶ **To close:** slide the sliding door to the right ❷ until it engages.

### Electrical step

#### Function of the electrical step

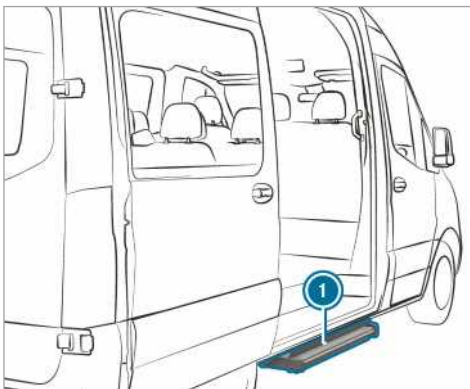

Your vehicle's sliding door may be equipped with an electrical step.

Electrical step ❶ automatically extends when the sliding door opens, and retracts after the slid-

ing door closes. Electrical step ❶ is equipped with obstacle detection at the front. If the step meets an obstacle while extending, it stops. When you have removed the obstacle, you must first close the sliding door then re-open it so that the step extends completely.

If the electrical step prevents loading, you can block it via obstacle detection when the sliding door opens. The electrical step then remains retracted and a fork-lift truck or other lifting vehicle can move closer to the load area.

- ❶ The display shows the **Step not extended See Owner's Manual** message or the **step not extended malfunction**.  
When the ignition is switched off, a warning tone sounds if obstacle detection is blocked. The tone lasts two minutes.  
When the ignition is switched on, the warning tone sounds continuously.

**Vehicles with an instrument display (colour display):** if the display shows the **Step not retracted See Owner's Manual** or **Step not extended See Owner's Manual** message and a warning tone sounds, electrical step ❶ is malfunctioning (→ page 369).

**Vehicles with an instrument display (black and white display):** if the display shows the **step not retracted malfunction** or **step not extended malfunction** message and a warning tone sounds, electrical step ❶ is malfunctioning (→ page 369).

If electrical step ❶ is malfunctioning, the step may not extend or retract, or only partially. After a malfunction occurs, you must retract and lock electrical step ❶ manually in order to continue driving (→ page 53). Before passengers exit the vehicle, inform them that electrical step ❶ may be missing.

### Releasing the electrical step in an emergency (manual retraction)

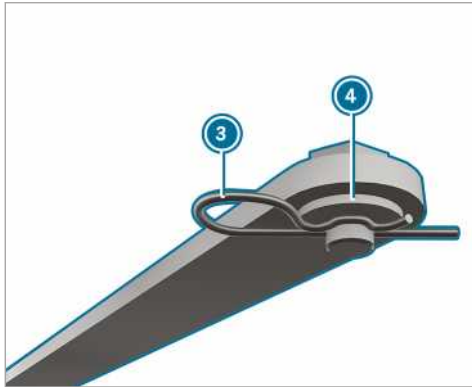
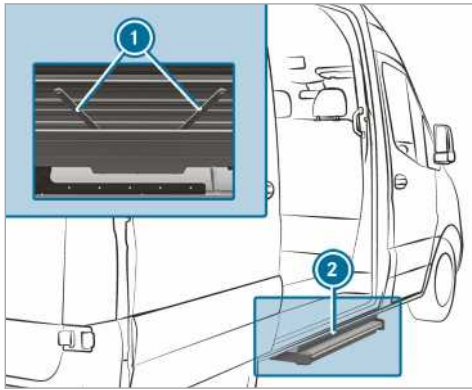

If the electrical step does not automatically retract, you must manually retract the step and lock it in order to continue driving.

- ▶ On the underside of step ② on both bars ① remove the spring cutters ③ from the pin.
- ▶ Remove the washers ④ and detach both bars.

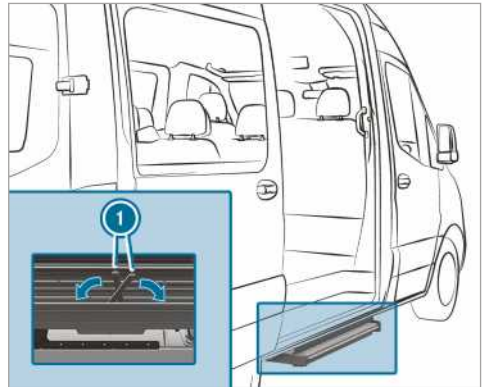

- ▶ Fold the bars ① into the step's housing.
- ▶ Slide the step into its housing.

ⓘ When securing the step for the first time, you must puncture a foil with the spring cutters.

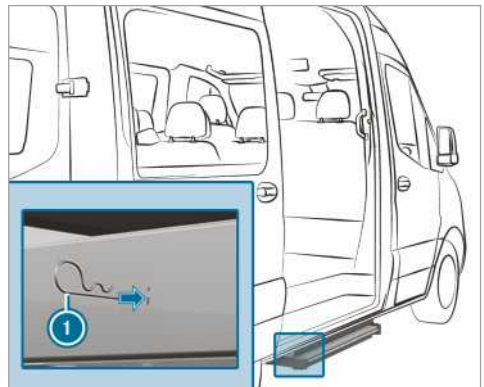

- ▶ On both sides, insert the spring cutters ① through the housing's holes and into the step as far as they will go.  
The step has been secured in its housing.

### Platform dropsides

#### Opening and closing platform dropsides

**⚠ WARNING** Risk of injury when opening a loaded dropside!

When opening the dropside locking mechanisms, the dropside may drop down. This is particularly the case if it is loaded, i.e. carrying a load.

- ▶ Before opening, ensure that there are no people in the dropside's swivel range.
- ▶ Always open the dropside locking mechanisms at the side of the dropside to be opened.
- ▶ Be particularly careful if the dropside locking mechanisms cannot be opened using the usual level of force.

**▲ WARNING** Risk of accident if the exterior lighting is covered by the dropside.

The exterior lighting at the rear is concealed when you open the rear dropside.

As a result, other road users cannot detect the vehicle as an obstacle until late.

- ▶ Protect the vehicle at the rear in accordance with national regulations, e.g. with a warning triangle.

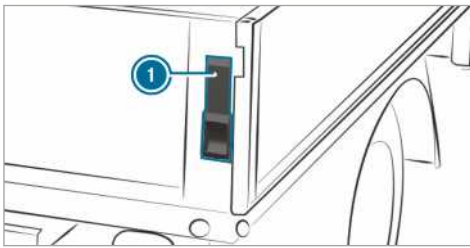

- ▶ **To open:** hold the platform dropside firmly.
- ▶ Fold the lever ① up as far as it will go.
- ▶ Repeat the procedure on the other side of the platform dropside.
- ▶ Fold the platform dropside up to the 90° position.

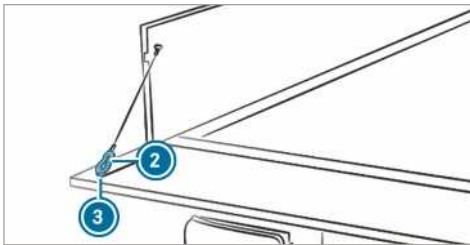

- ▶ Raise the platform dropside and unhook the holding rope snap hook ② from the eyelet ③.

- ▶ Repeat the procedure on the other side of the platform dropside.
- ▶ Carefully fold down the side platform dropside.
- ▶ **To close:** raise the platform dropside and hook the holding rope snap hook ② into the eyelet ③.
- ▶ Raise the platform dropside and press it closed.
- ▶ Fold the lever ① down as far as it will go.
- ▶ Repeat the procedure on the other side of the platform dropside.

### Attaching/detaching side platform dropside

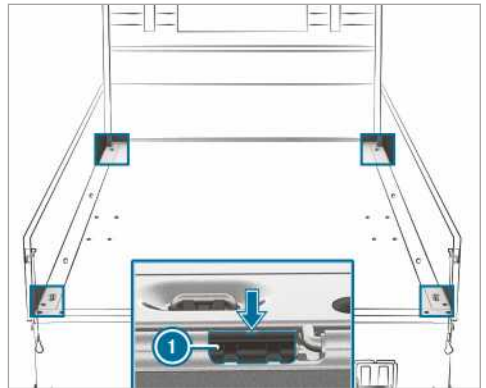

Perform these jobs carefully with the assistance of a second person.

- ▶ **To detach:** fold down the rear platform dropside.
- ▶ Fold down a side platform dropside.
- ▶ Lever locking pawl ① of the side platform dropside out of its guide using the screwdriver from the vehicle tool kit in the recess (arrow).
- ▶ Fold the platform dropside upwards to the 80° position (approximately).
- ▶ Pull the platform dropside out of the hinge pins to the rear and remove it.
- ▶ **To attach:** carefully place the platform dropside against the hinge pins in the 80° position (approximately); the locking pawl ① must lie on the platform dropside.
- ▶ Slide the platform dropside forwards.
- ▶ Insert locking pawl ① and fold up the platform dropside.

## Side window

### Opening and closing the side windows

- ⚠ WARNING** Risk of becoming trapped when opening a side window

When you open a side window, parts of the body could be drawn in or become trapped between the side window and window frame.

- ▶ When opening, make sure that nobody is touching the side window.
- ▶ If someone is trapped, release the button immediately or pull it in order to close the side window again.

- ⚠ WARNING** Risk of becoming trapped when closing a side window

When closing a side window, body parts could be trapped in the closing area in the process.

- ▶ When closing, make sure that no body parts are in the closing area.
- ▶ If someone is trapped, release the button immediately or press the button in order to reopen the side window.

- ⚠ WARNING** Risk of becoming trapped when children operate the side windows

Children could become trapped if they operate the side windows, particularly when unattended.

- ▶ Activate the override feature for the rear side windows.
- ▶ When leaving the vehicle, always take the key with you and lock the vehicle.
- ▶ Never leave children unattended in the vehicle.

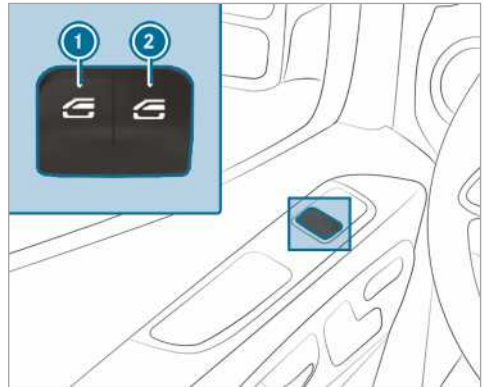

- ① Power window, left
- ② Power window, right

- ▶ **To open manually:** press and hold button ① or ②.
- ▶ **To close manually:** pull and hold button ① or ②.

The windows in the front doors can also be operated automatically.

- ▶ **To open completely:** briefly press button ① or ② beyond the point of resistance. Automatic operation will start.
- ▶ **To close completely:** briefly pull button ① or ② beyond the point of resistance. Automatic operation will start.
- ▶ **To interrupt automatic operation:** briefly press or pull button ① or ② again.

ⓘ If an object blocks a side window during the automatic closing process, the side window will open again automatically. The automatic reversing function is only an aid and is not a substitute for your attentiveness.

ⓘ If automatic operation of the side windows does not work, there is no anti-entrapment function.

### Automatic reversing function of the side windows

If an object blocks a side window during the closing process, the side window will open again automatically. The automatic reversing function is only an aid and is not a substitute for your attentiveness.

- ▶ When closing, make sure that no body parts are in the closing area.

**⚠ WARNING** Risk of becoming trapped despite there being reversing protection on the side window

The reversing function does not react:

- to soft, light and thin objects, e.g. small fingers
- over the last 4 mm of the closing path
- during resetting
- when closing the side window again manually immediately after automatic reversing

This means that the reversing function cannot prevent someone from becoming trapped in these situations.

- ▶ When closing, make sure that no body parts are in the closing area.
- ▶ If someone becomes trapped, press the  button to open the side window again.

### Ventilating the vehicle before starting a journey (convenience opening)

**⚠ WARNING** Risk of entrapment when opening a side window

When opening a side window, parts of the body could be drawn in or become trapped between the side window and window frame.

- ▶ When opening, make sure that nobody is touching the side window.
- ▶ Release the button immediately if somebody becomes trapped.

You can ventilate the vehicle before you start driving.

To do this, the key is used to carry out the following functions simultaneously:

- unlock the vehicle
- open the side windows

### Problems with the side windows

Problem	Possible causes/consequences and ▶ Solutions
A side window cannot be closed and the cause is not obvious.	▶ Check to see if there are any objects in the window guide.

The "convenience opening" function can only be operated using the key. The key must be in close proximity to the driver's or co-driver's door.

- ▶ Press and hold the  button on the key.

The following functions are performed:

- the vehicle is unlocked
- the side windows are opened

- ▶ **To interrupt convenience opening:** release the  button.

### Closing side windows from the outside (convenience closing)

**⚠ WARNING** Risk of entrapment caused by inadvertent convenience closing

When the convenience closing feature is operating, parts of the body could become trapped in the closing area of the side windows.

- ▶ Observe the complete closing procedure when using convenience closing.
- ▶ When closing, make sure that no body parts are in the closing area.

- ▶ Press and hold the  button on the key.

The following functions are performed:

- the vehicle is locked
- the side windows are closed

- ▶ **To interrupt convenience closing:** release the  button.

### Adjusting the side windows

The side windows must be readjusted after a malfunction or a voltage supply interruption.

- ▶ Switch on the ignition (→ page 110).
- ▶ Push both buttons on the power window and hold for approximately one second after the side window has closed.

Problem	Possible causes/consequences and ► Solutions
	<p><b>▲ WARNING</b> Risk of becoming trapped or fatally injured if reversing protection is not activated</p> <p>If you close a side window again immediately after it has been blocked or reset, the side window closes with increased or maximum force. The reversing feature is then not active.</p> <p>Parts of the body could become trapped in the closing area in the process.</p> <ul style="list-style-type: none"> <li>► Make sure that no parts of the body are in the closing area.</li> <li>► To stop the closing process, release the button or press the button again to reopen the side window.</li> </ul> <p>If a side window is obstructed during closing and reopens again slightly:</p> <ul style="list-style-type: none"> <li>► Immediately after the window gets stuck, pull the corresponding button again until the side window has closed, and hold the button for an additional second. The side window is closed with increased force.</li> </ul> <p>If a side window is obstructed again and reopens again slightly:</p> <ul style="list-style-type: none"> <li>► Repeat the previous step. The side window is closed without the automatic reversing function.</li> </ul>
The side windows cannot be opened or closed using the convenience opening feature.	<p>the key battery is weak or discharged</p> <ul style="list-style-type: none"> <li>► Check the battery with the battery indicator lamp and replace if necessary(→ page 42).</li> </ul>

## Anti-theft protection

### Function of immobiliser

The immobiliser prevents your vehicle from being started without the correct key.

The immobiliser is automatically activated when the ignition is switched off, and deactivated when the ignition is switched on.

### ATA (Anti-Theft Alarm system)

#### Function of ATA (Anti-Theft Alarm system)

If the ATA system is primed, a visual and audible alarm is triggered in the following situations:

- a side door is opened
- the rear door is opened
- the bonnet is opened
- the interior motion sensor is triggered (→ page 59)
- tow-away protection is triggered (→ page 58)

ATA is automatically switched on after approximately five seconds:

- after the vehicle has been locked with the key

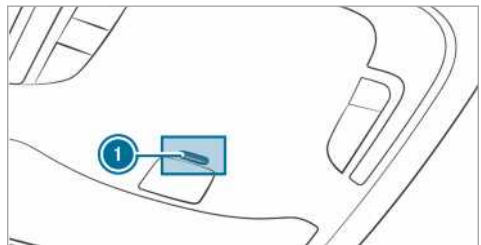

When the ATA system is primed, indicator lamp ① flashes in the overhead control panel.

ATA is automatically switched off:

- After unlocking the vehicle with the key.
- After pressing the start/stop button with the key inside the vehicle.

### Priming/deactivating ATA (Anti-theft Alarm system)

If the alarm system is primed, a visual and audible alarm is triggered by the following:

- opening a door
- opening the bonnet

**i** The alarm is not switched off, even if you immediately close the open door that has triggered it, for example.

#### Priming

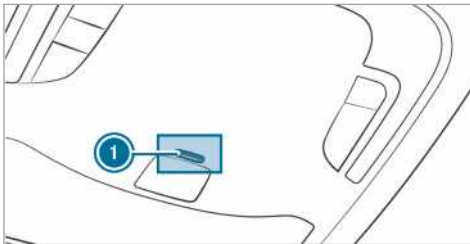

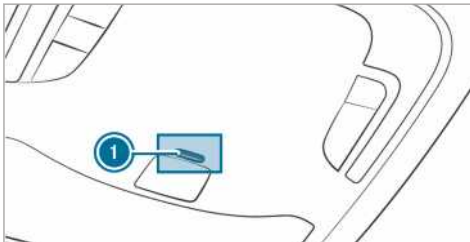

- ▶ Close all the doors.
- ▶ Lock the vehicle with the key. Indicator lamp **1** in the overhead control panel flashes.

#### Switching off



- ▶ Unlock the vehicle with the key. Indicator lamp **1** in the overhead control panel goes out.
- i** The vehicle locks again automatically if you do not open a door within 40 seconds after unlocking the vehicle.

#### Stopping the alarm

- ▶ Press the  or  button on the key. or
- ▶ Press the Start/Stop button with the key inside the vehicle. The alarm stops.

### Function of tow-away protection

#### Function of tow-away protection

A visual and audible alarm is triggered if the inclination of the vehicle changes when tow-away protection is primed. This can be the case if the vehicle is raised on one side, for example.

### Priming/deactivating tow-away protection

#### Priming/deactivating

- ▶ Lock the vehicle with the key. Tow-away protection is automatically primed after about 40 seconds:
- ▶ Open the vehicle with the key. Tow-away protection is deactivated.

Tow-away protection is only primed when the following components are closed:

- driver's door and co-driver door
- the side doors
- the rear doors

#### Deactivating

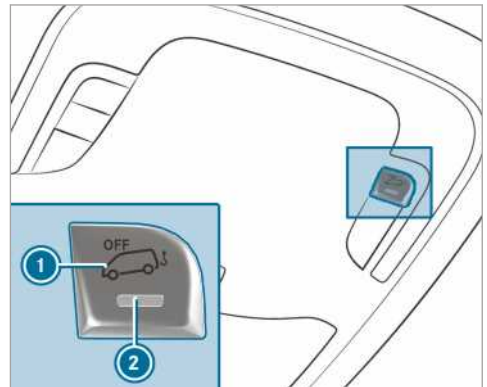

- ▶ Switch off the power supply (→ page 110).
- ▶ Press button **1**. When the button is released, indicator lamp **2** in the button lights up for approximately five seconds.
- ▶ Lock the vehicle with the key. Tow-away protection is deactivated.

Tow-away protection remains deactivated until you lock the vehicle again.



Deactivate tow-away protection when locking your vehicle and:

- loading and/or transporting the vehicle, on a ferry or car transporter, for example
- parking on a movable surface, such as split-level garage

This will prevent false alarms.

### Interior motion sensor

#### Function

If the primed interior motion sensor detects motion in the vehicle interior, a visual and acoustic alarm is triggered. This can happen if someone reaches into the vehicle interior, for example.

### Priming/deactivating the interior motion sensor

#### Priming

- ▶ Close the side windows.
- ▶ Make sure that nothing (such as mascots or coat hangers) is hanging on the rear-view mirror or on the grab handles on the roof lining. This will prevent false alarms.
- ▶ Lock the vehicle with the key.  
The interior motion sensor is primed after approximately 30 seconds.

Interior protection is only primed when the following components are closed:

- the driver's and the co-driver door
- the side doors
- the rear doors

#### Switching off

- ▶ Unlock the vehicle with the key.  
The interior motion sensor automatically switches off.

### Deactivating

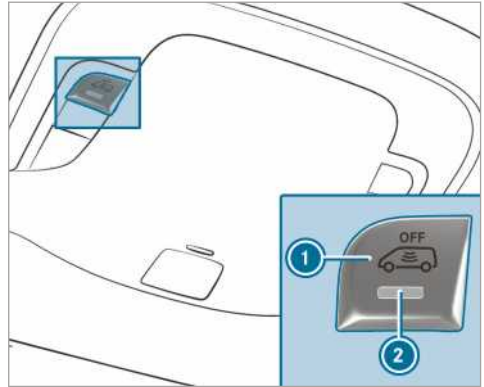

- ▶ Switch off the power supply (→ page 110).
- ▶ Press button ①.  
When the button is released, indicator lamp ② in the button lights up for about five seconds.
- ▶ Lock the vehicle with the key.  
The interior motion sensor is deactivated.

The interior motion sensor remains deactivated until you lock the vehicle again.

Deactivate the interior motion sensor when locking your vehicle:

- if there are people or animals remaining inside
- with the side windows remaining open
- when transporting it on a ferry or car transporter, for example

This will prevent false alarms.



### Correct driver's seat position

**⚠ WARNING** Risk of injury through adjusting vehicle settings while the vehicle is in motion

You could lose control of the vehicle in the following situations:

- if you adjust the driver's seat, the head restraints, the steering wheel or the mirror while the vehicle is in motion
- if you fasten your seat belt while the vehicle is in motion

▶ Before starting the engine: adjust the driver's seat, the head restraints, the steering wheel or the mirror and fasten your seat belt.

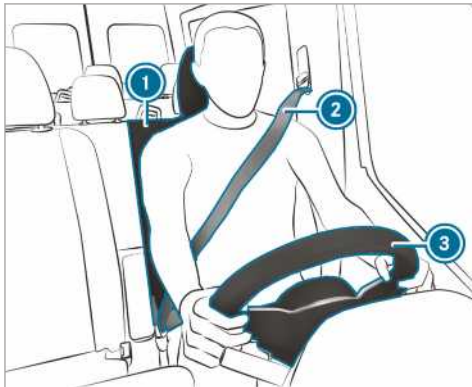

Comply with the following when adjusting the steering wheel ③, safety belt ② and driver's seat ①:

- Sit as far away as possible from the driver's airbag.
- Sit in an upright position.
- Your thighs are slightly supported by the seat cushion.
- Your legs are not fully extended and you can easily fully press on the pedals.
- The back of your head is supported at eye level by the middle part of the head restraint.
- You can reach the steering wheel with your arms in a slightly bent position.
- You can move your legs freely.
- You can easily see all displays on the instrument display.

- You have a good overview of the traffic situation.
- Your safety belt fits securely around your body and runs across the middle of your shoulder, your pelvic area and groin.

### Seats

#### Adjusting the front seats manually (without Seat Comfort Package)

**⚠ WARNING** Risk of becoming trapped if the seats are adjusted by children

Children could become trapped if they adjust the seats, particularly when unattended.

- ▶ When leaving the vehicle, always take the key with you and lock the vehicle.
- ▶ Never leave children unattended in the vehicle.

**⚠ WARNING** Risk of becoming trapped when adjusting the seats

When you adjust a seat, you or other vehicle occupants could become trapped, e.g. on the seat guide rail.

- ▶ When adjusting a seat, make sure that no one has any body parts in the sweep of the seat.

Comply with the safety notes on "Airbags" and "Children in the vehicle".

**⚠ WARNING** Risk of accident due to the driver's seat not being engaged

If the driver's seat is not engaged, it could move unexpectedly while the vehicle is in motion.

This could cause you to lose control of the vehicle.

- ▶ Always make sure that the driver's seat is engaged before starting the vehicle.

**⚠ WARNING** Risk of injury through adjusting vehicle settings while the vehicle is in motion

You could lose control of the vehicle in the following situations:

- if you adjust the driver's seat, the head restraints, the steering wheel or the mirror while the vehicle is in motion
  - if you fasten your seat belt while the vehicle is in motion
- ▶ Before starting the engine: adjust the driver's seat, the head restraints, the steering wheel or the mirror and fasten your seat belt.

**⚠ WARNING** Risk of becoming trapped if the seat height is adjusted carelessly

If you adjust the seat height carelessly, you or other vehicle occupants could be trapped and thereby injured.

Children in particular could accidentally press the electrical seat adjustment buttons and become trapped.

- ▶ While moving the seats, make sure that hands or other body parts do not get under the lever assembly of the seat adjustment system.

**⚠ WARNING** Risk of injury due to head restraints which are not fitted or are adjusted incorrectly

If head restraints are not fitted or are adjusted incorrectly, they cannot provide protection as intended.

There is an increased risk of injury in the head and neck area, e.g. in the event of an accident or when braking.

- ▶ Always drive with the head restraints fitted.
- ▶ Before driving off, make sure for every vehicle occupant that the centre of the head restraint supports the back of the head at about eye level.

Do not interchange the head restraints of the front and rear seats. Otherwise, you will not be able to set the height and inclination of the head restraints to the correct position.

Using the head restraint fore/aft adjustment, adjust the head restraint in such a way that it is as close to the back of the head as possible.

**⚠ WARNING** Risk of injury or death due to incorrect seat position

The seat belt does not offer the intended level of protection if you have not moved the seat backrest to an almost vertical position.

When braking or in the event of an accident, you could slide underneath the seat belt and sustain abdominal or neck injuries, for example.

- ▶ Adjust the seat properly before beginning your journey.
- ▶ Always ensure that the seat backrest is in an almost vertical position and that the shoulder section of your seat belt is routed across the centre of your shoulder.

**!** **NOTE** Damage to the seats when moving the seats back

The seats may be damaged by objects when moving the seats back.

- ▶ When moving the seats back, make sure that there are no objects in the footwell, under or behind the seats.

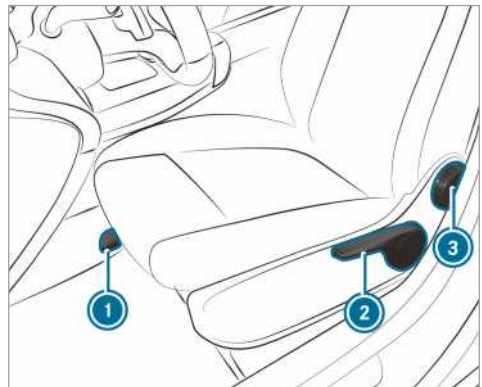

① Seat fore-and-aft adjustment

② Seat height

③ Seat backrest inclination

ⓘ Depending on the seat model, individual adjustment options may be omitted.

- ▶ **To set the seat fore-and-aft adjustment:** raise lever ① and slide the seat into the required position.
- ▶ Ensure that the seat is engaged.
- ▶ **To set the seat height:** keep on pressing or pulling lever ② until the required seat height has been reached.
- ▶ **To set the seat backrest inclination:** rotate handwheel ③ forwards and backwards until the required position has been reached.

### Adjusting the front seats manually (with Seat Comfort Package)

- ⚠ WARNING** Risk of becoming trapped if the seats are adjusted by children

Children could become trapped if they adjust the seats, particularly when unattended.

- ▶ When leaving the vehicle, always take the key with you and lock the vehicle.
- ▶ Never leave children unattended in the vehicle.

- ⚠ WARNING** Risk of becoming trapped when adjusting the seats

When you adjust a seat, you or other vehicle occupants could become trapped, e.g. on the seat guide rail.

- ▶ When adjusting a seat, make sure that no one has any body parts in the sweep of the seat.

Comply with the safety notes on "Airbags" and "Children in the vehicle".

- ⚠ WARNING** Risk of accident due to the driver's seat not being engaged

If the driver's seat is not engaged, it could move unexpectedly while the vehicle is in motion.

This could cause you to lose control of the vehicle.

- ▶ Always make sure that the driver's seat is engaged before starting the vehicle.

- ⚠ WARNING** Risk of injury through adjusting vehicle settings while the vehicle is in motion

You could lose control of the vehicle in the following situations:

- if you adjust the driver's seat, the head restraints, the steering wheel or the mirror while the vehicle is in motion
- if you fasten your seat belt while the vehicle is in motion

- ▶ Before starting the engine: adjust the driver's seat, the head restraints, the steering wheel or the mirror and fasten your seat belt.

- ⚠ WARNING** Risk of becoming trapped if the seat height is adjusted carelessly

If you adjust the seat height carelessly, you or other vehicle occupants could be trapped and thereby injured.

Children in particular could accidentally press the electrical seat adjustment buttons and become trapped.

- ▶ While moving the seats, make sure that hands or other body parts do not get under the lever assembly of the seat adjustment system.

- ⚠ WARNING** Risk of injury due to head restraints which are not fitted or are adjusted incorrectly

If head restraints are not fitted or are adjusted incorrectly, they cannot provide protection as intended.

There is an increased risk of injury in the head and neck area, e.g. in the event of an accident or when braking.

- ▶ Always drive with the head restraints fitted.
- ▶ Before driving off, make sure for every vehicle occupant that the centre of the head restraint supports the back of the head at about eye level.

Do not interchange the head restraints of the front and rear seats. Otherwise, you will not be able to set the height and inclination of the head restraints to the correct position.

Using the head restraint fore/aft adjustment, adjust the head restraint in such a way that it is as close to the back of the head as possible.

**⚠ WARNING** Risk of injury or death due to incorrect seat position

The seat belt does not offer the intended level of protection if you have not moved the seat backrest to an almost vertical position.

When braking or in the event of an accident, you could slide underneath the seat belt and sustain abdominal or neck injuries, for example.

- ▶ Adjust the seat properly before beginning your journey.
- ▶ Always ensure that the seat backrest is in an almost vertical position and that the shoulder section of your seat belt is routed across the centre of your shoulder.

**! NOTE** Damage to the seats when moving the seats back

The seats may be damaged by objects when moving the seats back.

- ▶ When moving the seats back, make sure that there are no objects in the footwell, under or behind the seats.



Sample image of comfort suspension seat

- ① Seat cushion length
- ② Seat backrest inclination
- ③ Seat height
- ④ Seat cushion inclination
- ⑤ Seat fore-and-aft adjustment

- ⑥ Seat suspension
- ⑦ Vibration limiting

**i** Depending on the seat model, individual adjustment options may be omitted.

- ▶ **To adjust the seat cushion length:** raise lever ① and slide the front part of the seat cushion forwards or backwards.
- ▶ **To set the seat backrest inclination:** rotate handwheel ② forwards and backwards until the required position has been reached.
- ▶ **To set the seat height:** pull or push lever ③ until the required position has been reached.
- ▶ **To set the seat cushion inclination:** rotate handwheel ④ forwards and backwards until the required position has been reached.
- ▶ **To set the seat fore-and-aft adjustment:** raise lever ⑤ and slide the seat into the required position.
- ▶ Ensure that the seat is engaged.
- ▶ **To set the seat suspension:** take the weight off the seat.
- ▶ On handwheel ⑥, set the body weight (40 kg to 120 kg) so that the seat suspension works optimally. If you set a higher weight, the seat suspension will become firmer. The seat will then not vibrate as much. If the seat vibrates often and significantly, you can engage it in the lower area.
- ▶ **To engage vibration limiting:** turn lever ⑦ upwards. The next time the seat vibrates, it will engage.
- ▶ **To release vibration limiting:** turn lever ⑦ to the right. The seat can vibrate.

### Adjusting the front seat electrically

**⚠ WARNING** Risk of becoming trapped if the seats are adjusted by children

Children could become trapped if they adjust the seats, particularly when unattended.

- ▶ When leaving the vehicle, always take the key with you and lock the vehicle.
- ▶ Never leave children unattended in the vehicle.

The seats can be adjusted while the ignition is off.

**⚠ WARNING** Risk of becoming trapped when adjusting the seats

When you adjust a seat, you or other vehicle occupants could become trapped, e.g. on the seat guide rail.

- ▶ When adjusting a seat, make sure that no one has any body parts in the sweep of the seat.

Comply with the safety notes on "Airbags" and "Children in the vehicle".

**⚠ WARNING** Risk of accident due to the driver's seat not being engaged

If the driver's seat is not engaged, it could move unexpectedly while the vehicle is in motion.

This could cause you to lose control of the vehicle.

- ▶ Always make sure that the driver's seat is engaged before starting the vehicle.

**⚠ WARNING** Risk of injury through adjusting vehicle settings while the vehicle is in motion

You could lose control of the vehicle in the following situations:

- if you adjust the driver's seat, the head restraints, the steering wheel or the mirror while the vehicle is in motion
- if you fasten your seat belt while the vehicle is in motion

- ▶ Before starting the engine: adjust the driver's seat, the head restraints, the steering wheel or the mirror and fasten your seat belt.

**⚠ WARNING** Risk of becoming trapped if the seat height is adjusted carelessly

If you adjust the seat height carelessly, you or other vehicle occupants could be trapped and thereby injured.

Children in particular could accidentally press the electrical seat adjustment buttons and become trapped.

- ▶ While moving the seats, make sure that hands or other body parts do not get under the lever assembly of the seat adjustment system.

**⚠ WARNING** Risk of injury due to head restraints which are not fitted or are adjusted incorrectly

If head restraints are not fitted or are adjusted incorrectly, they cannot provide protection as intended.

There is an increased risk of injury in the head and neck area, e.g. in the event of an accident or when braking.

- ▶ Always drive with the head restraints fitted.
- ▶ Before driving off, make sure for every vehicle occupant that the centre of the head restraint supports the back of the head at about eye level.

Do not interchange the head restraints of the front and rear seats. Otherwise, you will not be able to set the height and inclination of the head restraints to the correct position.

Using the head restraint fore/aft adjustment, adjust the head restraint in such a way that it is as close to the back of the head as possible.

**⚠ WARNING** Risk of injury or death due to incorrect seat position

The seat belt does not offer the intended level of protection if you have not moved the seat backrest to an almost vertical position.

When braking or in the event of an accident, you could slide underneath the seat belt and sustain abdominal or neck injuries, for example.

- ▶ Adjust the seat properly before beginning your journey.
- ▶ Always ensure that the seat backrest is in an almost vertical position and that the shoulder section of your seat belt is routed across the centre of your shoulder.

**! NOTE** Damage to the seats when moving the seats back

The seats may be damaged by objects when moving the seats back.

- ▶ When moving the seats back, make sure that there are no objects in the footwell, under or behind the seats.

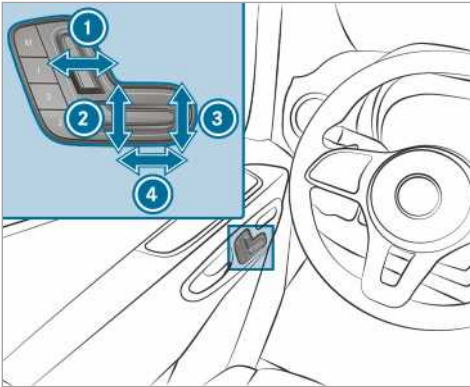

- ① Seat backrest inclination
  - ② Seat height
  - ③ Seat cushion inclination
  - ④ Seat fore-and-aft adjustment
- ▶ Save the settings with the memory function (→ page 65).

### Setting 4-way lumbar support

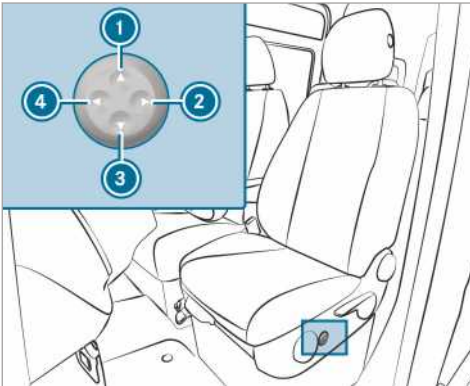

- ① Higher
  - ② Weaker
  - ③ Lower
  - ④ Stronger
- ▶ Use buttons ① to ④ to adjust the backrest curvature individually to your spine.

### Operating the memory function

**⚠ WARNING** Risk of an accident if the memory function is used while driving

If you use the memory function on the driver's side while driving, you could lose control of the vehicle as a result of the adjustments being made.

- ▶ Use the memory function on the driver's side when the vehicle is stationary.

**⚠ WARNING** Risk of entrapment when setting the seat with the memory function

When the memory function adjusts the seat, you and other vehicle occupants – particularly children – could become trapped.

- ▶ During the adjustment process of the memory function, make sure that no one has any body parts in the sweep of the seat.
- ▶ If somebody becomes trapped, immediately release the memory function position button. The adjustment process is stopped.

**⚠ WARNING** Risk of entrapment if the memory function is activated by children

Children could become trapped if they activate the memory function, particularly when unattended.

- ▶ Never leave children unattended in the vehicle.
- ▶ When leaving the vehicle, always take the key with you and lock the vehicle.

The memory function can be used when the ignition is switched off.

### Storing seat settings

Seat settings for up to three people can be stored and called up using the memory function. You can adjust the seat and the backrest.

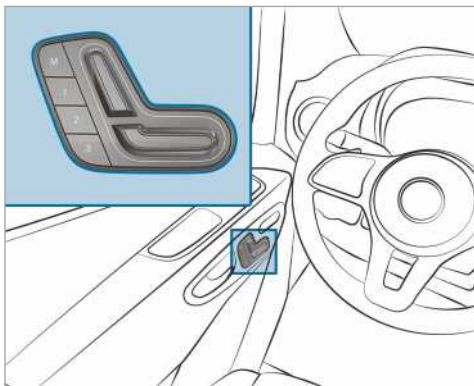

- ▶ Adjust the seat into the desired position.
- ▶ Press memory button M together with one of the preset position buttons 1, 2 or 3. An acoustic signal sounds. The settings are stored.
- ▶ **To call up:** press and hold the relevant preset position button 1, 2 or 3 until the front seat is in the stored position.

### Rotating the front seats

**⚠ WARNING** Risk of injury or death if the driver's seat and co-driver's seat are not engaged

If the driver's- and co-driver's seats are not engaged in the direction of travel during the trip, the restraint systems cannot offer protection as intended.

- ▶ Engage the driver's- and co-driver's seat in the direction of travel before the engine is started.



You can rotate the driver's and front passenger seat 50° and 180°. The seats engage both in and opposite to the direction of travel as well as at 50° to the exit.

- ▶ Ensure that the parking brake is applied and the brake lever is folded downwards as far as it will go (→ page 141).
- ▶ Adjust the steering wheel in such a way that there is sufficient free space to rotate and adjust the driver's seat (→ page 72).
- ▶ Slide the front passenger seat forward before rotating it (→ page 60).
- ▶ **To rotate the seat:** push lever ① towards the vehicle centre and rotate the seat slightly inwards. The rotation device is unlocked.
- ▶ Release lever ① again.
- ▶ Rotate the seat by around 50° outwards or inwards into the required position.



## Moving the co-driver bench seat cushion forwards and backwards



- ▶ **To fold the seat cushion forwards:** lift the seat cushion out of the front anchorage ①.
  - ▶ Pull the seat cushion out of the rear anchorage ② and move it slightly forwards.
  - ▶ Fold the rear edge of the seat cushion upwards.
- ⓘ You can stow individual objects in the stowage space beneath the co-driver bench seat.
- ▶ **To fold the seat cushion backwards:** fold the rear edge of the seat cushion downwards.
  - ▶ Slide the seat cushion under the seat backrest into the rear anchorage ②.
  - ▶ Push the front seat cushion downwards until it engages in the front anchorage ①.

## Adjusting armrests

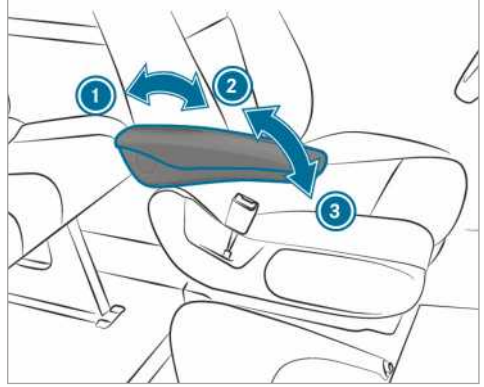

Example image

- ▶ **To set the armrest inclination:** Fold the armrest more than 45° upwards ②. The armrest is unlocked.
- ▶ Fold the armrest forwards ③ as far as it will go.
- ▶ Slowly fold the armrest upwards into the required position.
- ▶ **To fold the armrest upwards:** if necessary, fold the armrest more than 90° upwards ①.

## Folding the folding seat up or down

**⚠ WARNING** Risk of injury when using the folding seat due to inserted key

When the key is in the lock of the partition sliding door, it can come into contact with the person on the folding seat.

- ▶ Always remove the key from the partition sliding door before a person sits on the folding seat.



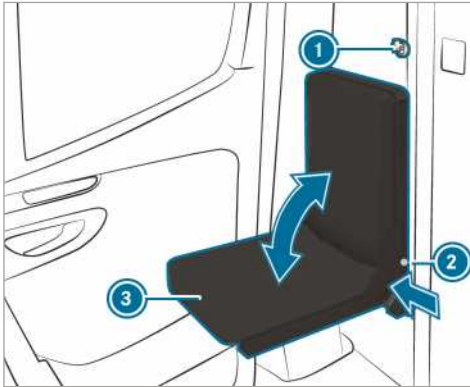

- ▶ Remove key ① from the partition sliding door.
- ▶ Press the push button on catch ② and fold seat cushion ③ up or down.
- ▶ Release push button ② when seat cushion ③ reaches its end position.
- ▶ Move seat cushion ③ until it has locked. The push button on catch ② must be completely on the seat frame.

### Installing and removing the rear bench seat

#### **▲ WARNING** Risk of injury if rear bench seat is installed incorrectly

If you do not install the rear bench seat as described, or install an unsuitable rear bench seat, the seat belts may not provide the intended protection.

- ▶ Install the rear bench seat as described and only in the direction of travel.
- ▶ Installing the rear bench seat in the opposite direction is not permitted.
- ▶ Use only rear bench seats approved for your vehicle by Mercedes-Benz.

#### **▲ WARNING** Risk of injury if rear bench seat is not locked in place

If the locking mechanisms on the rear bench seat legs are not correctly engaged, the rear bench seat will not be held firmly and could overturn during travel.

- ▶ Ensure that the rear bench seat is engaged before setting off. There must

be no red indicator tabs visible on the release handle.

- ▶ If red indicator tabs are visible on the release handle, re-engage the rear bench seat into place.

#### **!** NOTE Damage to rear bench seat rollers caused by incorrect use

The rear bench seat rollers can be damaged if the rear bench seat is used improperly or is removed incorrectly.

- ▶ As long as the rear bench seat is in the mounting shells, do not pull these in the direction of the rear doors. Roll the rear bench seat only beside the mounting shells.
- ▶ Do not roll the rear bench seat when it has been removed or use it as a means of transport.



Warning on rear bench seat with correctly installed rear bench seat shown.

### Installation position of three-person rear bench seat

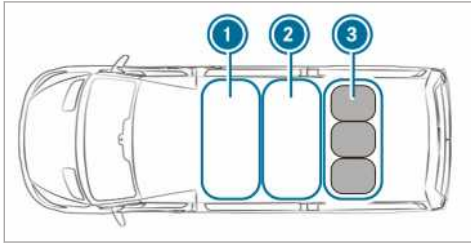

- ① First row of seats
- ② Second row of seats
- ③ Third row of seats with three-person rear bench seat

▶ Install the three-person rear bench seat only on the third row of seats ③ above the rear axle.

### Removing the rear bench seat

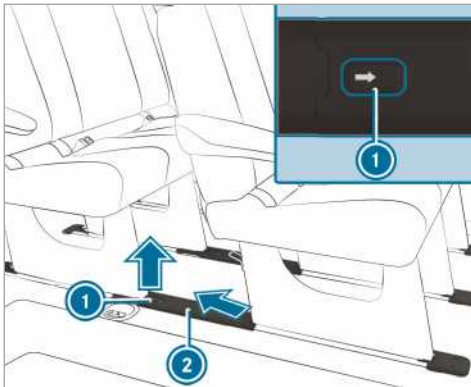

▶ **To remove the covers of the mounting shells:** push clip ① in the direction of the arrow and detach cover ② by pushing to the top rear at an angle.

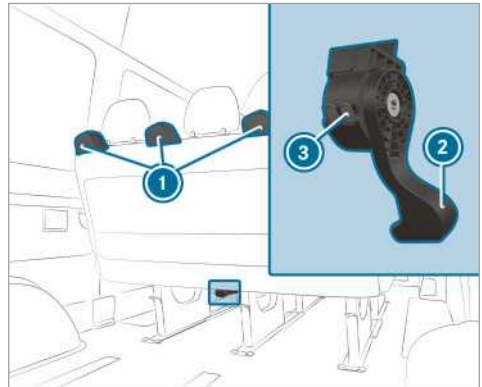

- ▶ Push release handle ② for the bench seat all the way down and hold it there while tilting the bench seat backwards slightly at the same time using the release handle and pull it slightly backwards.
- ▶ Let go of the release handle. The locks on the bench seat legs are unlocked and red indicator tabs ③ on the housing of release handle ② are visible.
- ▶ Hold the unlocked bench seat by grab handles ① and pull backwards slightly.

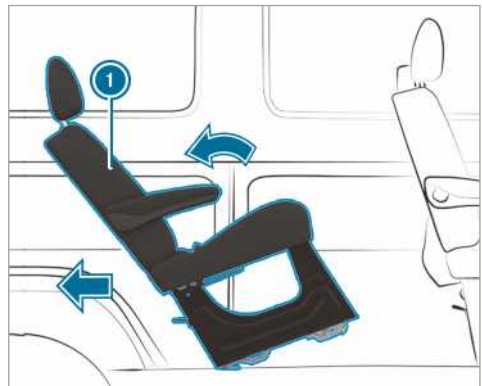

▶ Tilt bench seat ① backwards and pull it out of the mounting shells.

- ⓘ If the bench seat cannot be pulled out of the mounting shells, the bench seat may be wedged in the seat anchorage. This can happen if the bench seat is tilted too far backwards.

If the bench seat cannot be pulled out of the mounting shells:

- ▶ Tilt the bench seat forwards without engaging it.
- ▶ Pull the bench seat backwards again using release handle ②.
- ▶ Tilt the bench seat backwards slightly and pull it out of the mounting shells.
- ▶ To remove or store the bench seat, place it next to the mounting shells and roll it towards the rear doors.

or

- ▶ Lift the bench seat out from the side to store it.
- ⓘ It may be necessary for the bench seats in front or behind to be removed.

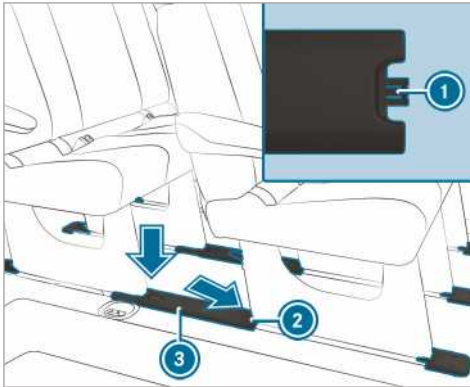

- ▶ **To attach the covers of the mounting shells:** hold cover ③ such that retaining lug ① is pointing towards rear seat anchorage ②.
- ▶ Insert cover ③ into the rear seat anchorage ② by pushing it downwards at an angle and then clip it to the mounting shell.

### Installing the rear bench seat

Secure engagement of the rear bench seat is guaranteed only if you keep the seat anchorages clean and free of objects.

- ⓘ In vehicles registered as passenger vehicles, observe the maximum permitted number of seats.
- ▶ Remove the covers of the mounting shells as described under "Removing the rear bench seat".
  - ▶ Position the bench seat behind the installation position.

- ▶ Hold the bench seat by the grab handles and tilt it backwards.
- ▶ Roll the bench seat forwards on the mounting shells.
- ▶ Ensure that the bench seat rear legs are engaged.

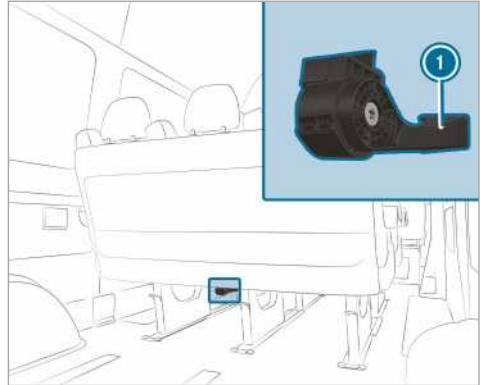

- ▶ Tilt the bench seat forwards firmly until the locks on the bench seat front legs engage audibly. The locks on the bench seat front legs will now be locked and the red indicator tabs on the housing of release handle ① should no longer be visible.
- ⓘ If the red indicator tabs on the release handle housing are visible, the bench seat is not correctly engaged.

If the bench seat is not correctly engaged:

- ▶ Unlock the bench seat again and tilt it forwards firmly until the locks on the bench seat front legs engage audibly.
- ▶ Attach the covers of the mounting shells as described under "Removing the rear bench seat".

## Adjusting the seat backrest of the rear bench seat

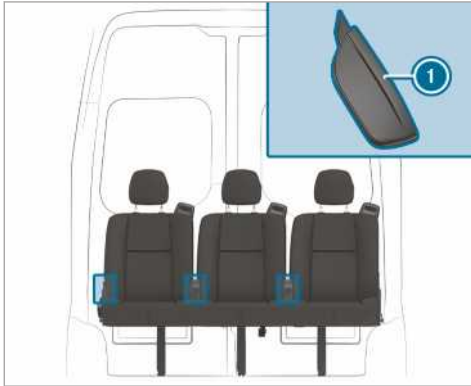

- ▶ Pull release handle ① for the seat backrest upwards and hold it in position.
- ▶ Move the seat backrest to the desired position.
- ▶ Let go of release handle ① for the seat backrest and move the seat backrest slightly. The seat backrest engages in position.

## Head restraints

### Adjusting the head restraints manually

**⚠ WARNING** Risk of injury through adjusting vehicle settings while the vehicle is in motion

You could lose control of the vehicle in the following situations:

- if you adjust the driver's seat, the head restraints, the steering wheel or the mirror while the vehicle is in motion
  - if you fasten your seat belt while the vehicle is in motion
- ▶ Before starting the engine: adjust the driver's seat, the head restraints, the steering wheel or the mirror and fasten your seat belt.

**⚠ WARNING** Risk of injury due to head restraints which are not fitted or are adjusted incorrectly

If head restraints are not fitted or are adjusted incorrectly, they cannot provide protection as intended.

There is an increased risk of injury in the head and neck area, e.g. in the event of an accident or when braking.

- ▶ Always drive with the head restraints fitted.
- ▶ Before driving off, make sure for every vehicle occupant that the centre of the head restraint supports the back of the head at about eye level.

Do not interchange the head restraints of the front and rear seats. Otherwise, you will not be able to set the height and inclination of the head restraints to the correct position.

Using the head restraint fore/aft adjustment, adjust the head restraint in such a way that it is as close to the back of the head as possible.

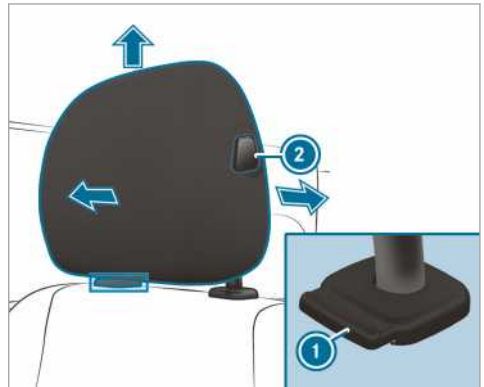

Head restraint (example of comfort head restraint on the driver's seat)

- ▶ **To raise:** pull the head restraint upwards into the required position and ensure that the head restraint is engaged. Only use the head restraint in the engaged state.
- ▶ **To lower:** push release button ① and slide the head restraint downwards into the required position and ensure that the head restraint is engaged. Only use the head restraint in the engaged state.
- ▶ **To move forwards:** push release button ② and pull the head restraint forwards until it engages in the required position.
- ▶ **To move backwards:** push release button ② and slide the head restraint backwards into the required position.

- ⓘ Depending on the head restraint model, individual adjustment options may be omitted.

### To switch seat heating on/off

**⚠ WARNING** Risk of burns due to repeatedly switching on the seat heater

Repeatedly switching on the seat heater can cause the seat cushion and seat backrest padding to become very hot.

The health of persons with limited temperature sensitivity or a limited ability to react to excessively high temperatures may be affected or they may even suffer burn-like injuries.

- ▶ Do not repeatedly switch on the seat heater.

**! NOTE** Damage to the seats caused by objects or documents when the seat heater is switched on

When the seat heater is switched on, overheating can occur due to objects or documents placed on the seats e.g. seat cushions or child seats. This could cause damage to the seat surface.

- ▶ Make sure that no objects or documents are on the seats when the seat heater is switched on.

#### Requirements:

- The voltage supply has been switched on.

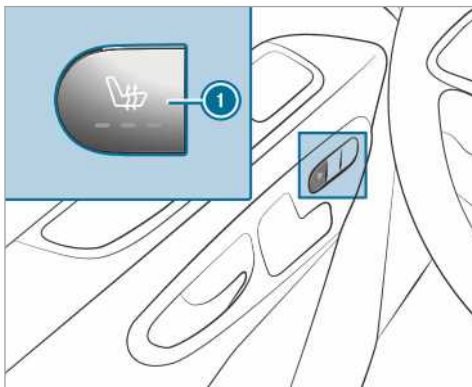

- ▶ **To switch on:** press the ① button. All indicator lamps on the button light up.

- ▶ **To lower the level:** keep on pressing the ① button until the required heating level is reached. Depending on the heating level, one to three indicator lamps light up.

- ▶ **To switch off:** keep on pressing the ① button until all indicator lamps are off.

- ⓘ Seat heating automatically switches back out of the three heating levels after 8, 10 and 20 minutes until seat heating switches off.

### Adjusting the steering wheel

**⚠ WARNING** Risk of injury through adjusting vehicle settings while the vehicle is in motion

You could lose control of the vehicle in the following situations:

- if you adjust the driver's seat, the head restraints, the steering wheel or the mirror while the vehicle is in motion
- if you fasten your seat belt while the vehicle is in motion

- ▶ Before starting the engine: adjust the driver's seat, the head restraints, the steering wheel or the mirror and fasten your seat belt.

**⚠ WARNING** Risk of entrapment for children when adjusting the steering wheel

Children could injure themselves if they adjust the steering wheel.

- ▶ Never leave children unattended in the vehicle.
- ▶ When leaving the vehicle, always take the key with you and lock the vehicle.

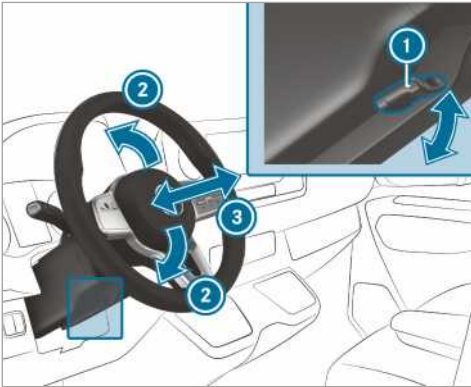

- ① Lever
- ② Steering column height
- ③ Steering column fore-and-aft adjustment

- ▶ **To adjust the steering wheel:** swing lever ① down as far as it will go. The steering wheel is unlocked.
- ▶ Move the steering wheel to the desired position.
- ▶ Pull lever ① up as far as it will go. The steering wheel is locked.

## Stowage areas

### Notes on loading guidelines

#### **▲ WARNING** Risk of exhaust gas poisoning

Combustion engines emit poisonous exhaust gases such as carbon monoxide. Exhaust gases can enter the vehicle interior if the rear-end door is open when the engine is running, especially if the vehicle is in motion.

- ▶ Always switch off the engine before opening the rear-end door.
- ▶ Never drive with the rear-end door open.

#### **▲ WARNING** Risk of injury from unsecured objects in the vehicle

When objects are unsecured or inadequately secured, they can slip, tip over or be thrown about, striking vehicle occupants.

This also applies to:

- luggage or loads

- seats which have been removed and are being transported in the vehicle in an exceptional case

There is a risk of injury, particularly in the event of braking manoeuvres or abrupt changes in direction.

- ▶ Always stow objects in such a way that they cannot be tossed about.
- ▶ Before travelling, secure objects, luggage or load to prevent them slipping or tipping over.
- ▶ When a seat is removed, keep it preferably outside the vehicle.

#### **▲ WARNING** Risk of injury due to objects being stowed incorrectly

If objects in the vehicle interior are stowed incorrectly, they can slide or be thrown around and hit vehicle occupants. In addition, cup holders, open stowage spaces and mobile phone brackets cannot always retain all objects they contain.

There is a risk of injury, particularly in the event of sudden braking or a sudden change in direction.

- ▶ Always stow objects so that they cannot be thrown around in such situations.
- ▶ Always make sure that objects do not protrude from stowage spaces, luggage nets or stowage nets.
- ▶ Close the lockable stowage spaces before starting a journey.
- ▶ Stow and secure objects that are heavy, hard, pointed, sharp-edged, fragile or too large in the load compartment.

#### **▲ WARNING** Risk of burning from the tailpipe or tailpipe trim

The tailpipe and tailpipe trim can become very hot. If you come into contact with these car parts, you could burn yourself.

- ▶ Always be particularly careful when in the vicinity of the tailpipe and tailpipe trims and supervise children very closely when in this area.
- ▶ Before any contact, allow the car parts to cool down.

If you are using a roof rack, please note the maximum roof load and the maximum load capacity of the roof rack.

You will find information about the maximum roof load in the "Technical data" chapter and information about roof racks in the "Carrier systems" section .

Camera-based driving systems and the sensor functions of the inside rearview mirror may be impaired if you are transporting a load on the roof and it protrudes more than 40 cm over the edge of the roof. Therefore, make sure that the load does not overhang by more than 40 cm.

The handling characteristics of your vehicle are dependent on the load distribution. Therefore, please observe the following notes when loading:

- when transporting a load, never exceed the permissible gross mass or the permissible axle loads for the vehicle (including occupants).
- the load must not protrude above the upper edge of the seat backrests.
- if possible, always transport the load in the load compartment.
- fasten the load to the tie-down eyes and spread the load as evenly as possible.
- use tie-down eyes and fastening components which are suitable for the weight and size of the load.

### Overview of the front stowage compartments

#### **Overview of the front stowage compartments**

Observe the notes on loading the vehicle (→ page 73).

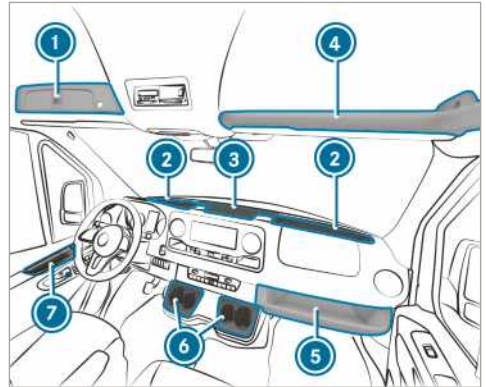

- ① Lockable compartment above windscreen (→ page 75)
- ② Windscreen stowage compartment with two cupholders / ashtray stowage space  
Stowage compartment with cover, depending on specification (→ page 74)
- ③ Centre console stowage compartment with USB connection, charging interface, NFC interface and 12-V socket
- ④ Stowage compartment above windscreen (subject to a maximum load of 2.5 kg)
- ⑤ Front passenger stowage compartment (subject to a maximum load of 5 kg)
- ⑥ Cup holder
- ⑦ Stowage compartment in the doors

#### **Centre console stowage compartment / opening and closing the windscreen**

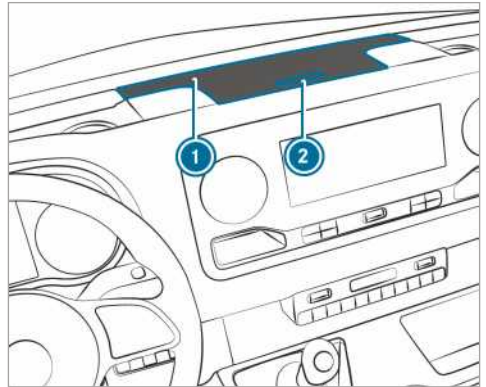

Stowage compartment cover (example: centre console)



▶ **To open:** press button ② on stowage compartment ①.  
The cover folds upwards.

▶ **To close:** fold the cover downwards.

① The windscreen stowage compartments have a cover, depending on the specification.

### Opening and closing the lockable compartment above the windscreen

You can lock and unlock the stowage compartment with the emergency key (→ page 42).

#### To open

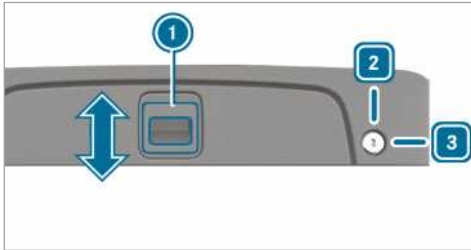

▶ **To unlock:** turn the emergency key clockwise to position ③.

▶ Slide handle ① upwards in the direction of the arrow.

▶ Swivel the cover upwards.

#### To close

▶ Fold the cover downwards and slide handle ① downwards in the direction of the arrow.

▶ **To lock:** turn the emergency key anti-clockwise to position ②.

### Opening the glasses compartment



▶ Press button ①.

### Using the stowage box

**▲ WARNING** Risk of injury due to incorrectly stowed or open stowage box

If you stow the stowage box in the vehicle interior incorrectly, it can slide or be thrown around and hit vehicle occupants. In addition, open stowage spaces may not, in the event of an accident, hold back all the objects they contain.

There is a risk of injury, particularly in the event of braking manoeuvres or abrupt changes in direction.

- ▶ Secure the stowage box with the seat belt.
- ▶ Before driving off, close the cover of the stowage box.
- ▶ Stow and secure objects that are heavy, hard, pointed, sharp-edged, fragile or too large in the load compartment.

### Attaching the stowage box

The stowage box is stowed beneath the front passenger bench seat.

Use the stowage box for the following:

- to store documents
  - to stow a mobile phone or small objects
  - as a writing support
- ▶ Fold the seat cushion of the front passenger bench seat forwards (→ page 67).
  - ▶ Remove the stowage box from the stowage compartment.
  - ▶ Fold back the seat cushion of the front passenger bench seat (→ page 67).



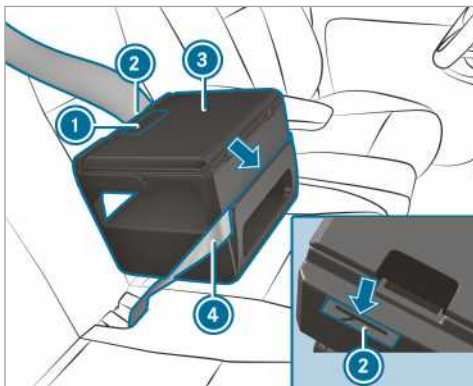

- ▶ Place stowage box ③ onto the seat.
- ▶ Push stowage box ③ lightly downwards into the seat cushion, and slide it backwards against the backrest.
- ▶ Ensure that the anchoring rib on the underside of the stowage box between the seat cushion and backrest is clamped in place.
- ▶ Thread seat belt ④ through the slot on the front of stowage box ③.
- ▶ Thread seat belt ④ through slot ② on the rear of the stowage box, tighten it and fasten it.
- ▶ Check that the stowage box is seated firmly.

#### Opening and closing the stowage box

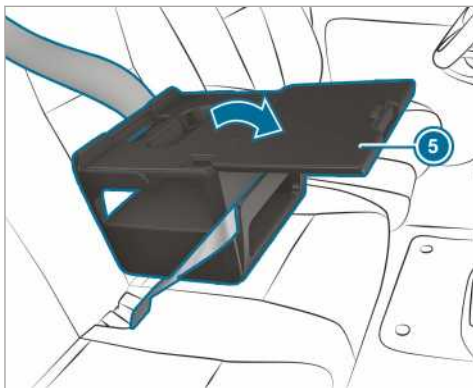

- ▶ **To open:** pull handle ① and open cover ⑤ in the direction of the arrow.
- ▶ Stowing objects.

- ① Information about further accessories such as tablet holders is available from any Mercedes-Benz service centre.
- ① While driving, keep the cover of the stowage box closed.
- ▶ **To close:** fold cover ⑤ back and press it closed so that handle ① engages.

#### Stowing the stowage box

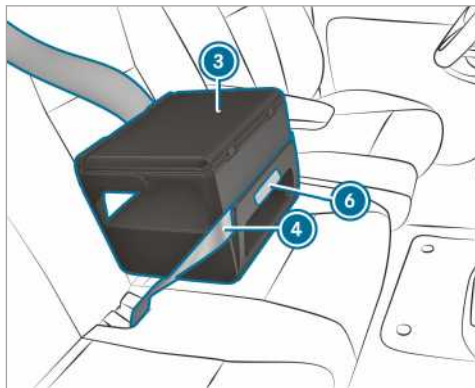

- ▶ Loosen the seat belt ④.
- ▶ Hold stowage box ③ in the area indicated ⑥ and pull it forwards in a straight line. The anchoring rib will release from the gap between the seat cushion and backrest.
- ▶ Take stowage box ③ off the seat.
- ▶ Fold the seat cushion of the front passenger bench seat forwards (→ page 67).
- ▶ Place stowage box ③ in the stowage compartment.
- ▶ Fold back the seat cushion of the front passenger bench seat (→ page 67).

## Information about the bottle holder

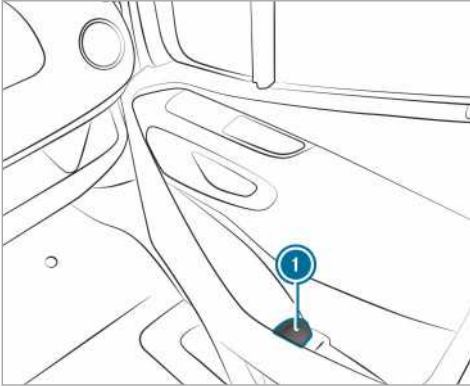

- ① Bottle holder in the front doors (example: co-driver's door)

## Cup holder

### Opening the cupholder in the rear

**⚠ WARNING** Risk of injury when getting out, due to extended cupholder

If the cupholder in the rear has been extended when you are getting out, you may bump into it.

- ▶ Before getting out, slide the cupholder back under the rear bench seat.

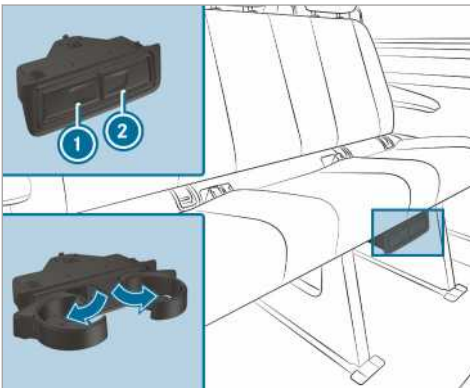

- ▶ **To open:** press the cupholder ① or ②.
- ▶ Fold out the cupholder.
- ▶ **To close:** slide the cupholder ① or ② back in until it engages.

## Ashtray and cigarette lighter

### Using ashtrays

#### While driving

- ▶ Place the closed ashtray in a cup holder in the windscreen stowage compartments while driving.
- ▶ Check that the ashtray is seated securely.
- ⓘ Do not place the ashtray in the centre console cup holders. It cannot sit securely here.

#### To open

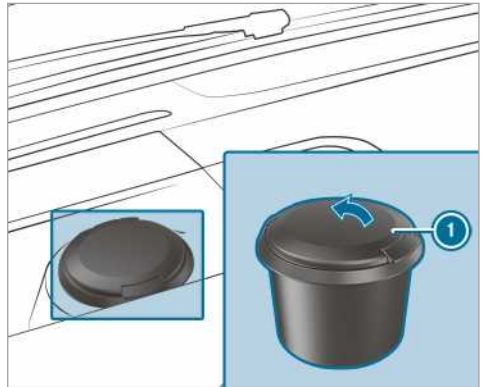

- ▶ Fold the cover ① upwards.

### Using the cigarette lighter in the centre console

**⚠ WARNING** - Risk of fire and injury from the hot cigarette lighter

You can burn yourself if you touch the hot heating element or the socket of the cigarette lighter.

In addition, flammable materials may ignite if:

- you drop the hot cigarette lighter
- a child holds the hot cigarette lighter to objects, for example

- ▶ Always hold the cigarette lighter by the knob.
- ▶ Always make sure that the cigarette lighter is out of reach of children.
- ▶ Never leave children unattended in the vehicle.

**Requirements:**

- The ignition is switched on.

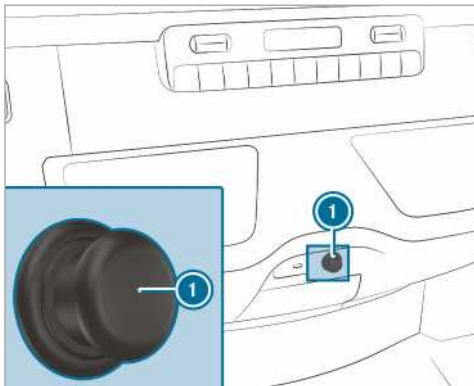

- ▶ Press in cigarette lighter ①. The cigarette lighter will pop out when the heating element is red-hot.

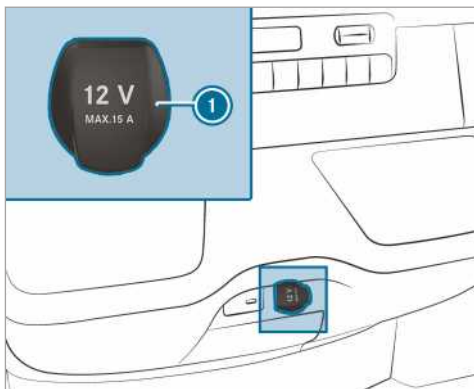
**12 V socket in lower control panel**

- ▶ Lift up cover ① of the socket.
- ▶ Insert the plug of the device.

**Sockets****Using 12 V sockets in the centre console****Requirements:**

- Only devices with a maximum power consumption of 180 W (15 A) may be connected.

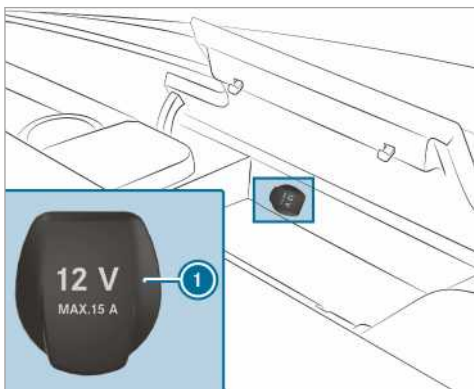
**12 V socket in stowage compartment**

- ▶ Open the lid of the stowage compartment in the centre console (→ page 74).
- ▶ Fold up cover ① of the socket.
- ▶ Insert the plug of the device.

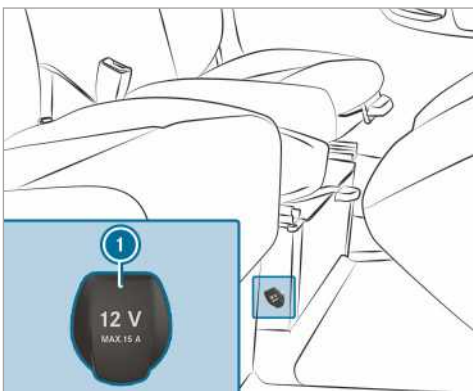
**Using 12 V socket on the driver's seat**

- ▶ Fold up cover ① of the socket.
- ▶ Insert the plug of the device.

**Notes on the 230 V socket**

**!** **NOTE** Damage to the auxiliary battery due to full discharge

The auxiliary battery may become damaged if a device with too high a power output is connected when you leave the vehicle, or the auxiliary battery's charge level is low.

- ▶ Only connect devices up to a maximum of 150 W.

- ▶ Do not leave devices connected for longer than four hours.

With 150 W, the 230 V socket provides a high power output which enables mobile phones to charge quickly and to connect battery chargers for tools.

Vehicles with an auxiliary battery have a run-on function. If you leave the vehicle, you can charge devices over a period of four hours.

### Using the 230 V socket in the centre console

**⚠ DANGER** Risk of fatal injury due to damaged connecting cables or sockets

When a suitable device is connected, the 230 V power socket will be carrying a high voltage. You could receive an electric shock if the connecting cable or the 230 V power socket is pulled out of the trim or is damaged or wet.

- ▶ Use only connecting cables that are dry and free of damage.
- ▶ When the ignition is switched off, make sure that the 230 V power socket is dry.
- ▶ Immediately have the 230 V power socket checked or replaced at a qualified specialised workshop if it is damaged or has been pulled out of the trim.
- ▶ Never plug the connecting cable into a 230 V power socket that is damaged or has been pulled out of the trim.

**⚠ DANGER** Risk of fatal injury due to incorrect handling of the socket

You could receive an electric shock:

- if you reach into the socket.
  - if you insert unsuitable devices or objects into the socket.
- ▶ Only connect suitable devices to the socket.

### Requirements:

- Only connect devices with a suitable plug which conforms to the standards specific to the country you are in.
- Only connect devices up to a maximum of 150 W.
- Do not use multiple socket outlets.

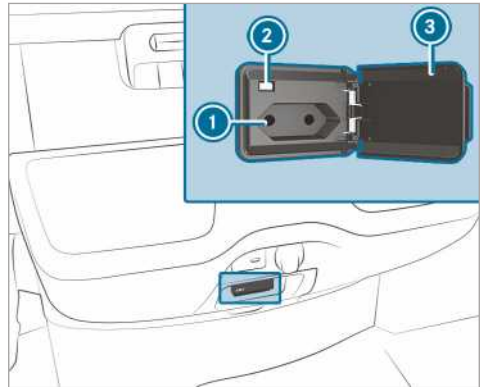

- ▶ Open flap (3).
- ▶ Insert the plug of the device into 230 V socket (1).  
When the on-board electrical system voltage is sufficient, indicator lamp (2) lights up.

If you will not be using the 230 V power socket, keep the flap closed.

### Using sockets in the load compartment

#### Requirements:

- Only devices with a maximum power consumption of 180 W (15 A) may be connected.

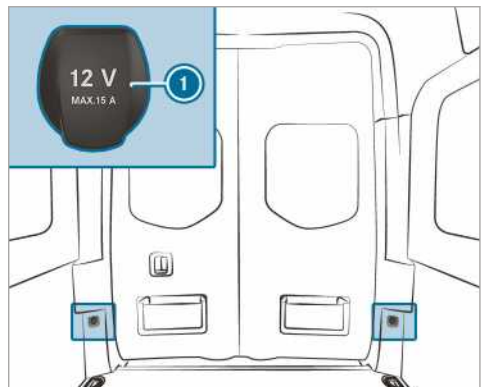

- ▶ Fold up cover (1) of the socket.
- ▶ Insert the plug of the device.

### Charging a mobile phone using the USB socket in the rear

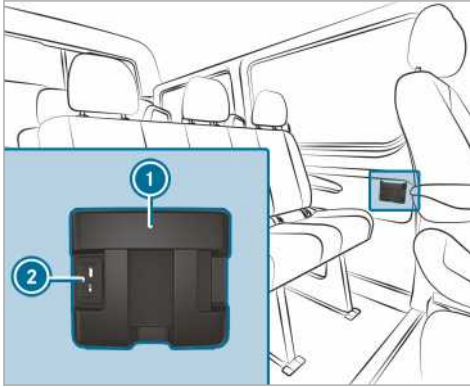

- ▶ Place the mobile phone in stowage compartment ① and connect it to USB socket ② to charge.

### Wirelessly charging the mobile phone and coupling with the exterior aerial

#### Notes on wirelessly charging the mobile phone

**⚠ WARNING** Risk of injury due to objects being stowed incorrectly

If objects in the vehicle interior are stowed incorrectly, they can slide or be thrown around and hit vehicle occupants. In addition, cup holders, open stowage spaces and mobile phone brackets cannot always retain all objects they contain.

There is a risk of injury, particularly in the event of sudden braking or a sudden change in direction.

- ▶ Always stow objects so that they cannot be thrown around in such situations.
- ▶ Always make sure that objects do not protrude from stowage spaces, luggage nets or stowage nets.
- ▶ Close the lockable stowage spaces before starting a journey.
- ▶ Stow and secure objects that are heavy, hard, pointed, sharp-edged, fragile or too large in the load compartment.

Comply with the instructions for loading the vehicle.

**⚠ WARNING** Risk of fire from placing objects in the mobile phone stowage compartment

If you place objects in the mobile phone stowage compartment, they may heat up excessively and even catch fire.

- ▶ Do not place additional objects, especially those made of metal, in the mobile phone stowage compartment.

**! NOTE** Damage to objects caused by placing them in the mobile phone stowage compartment

If you place objects in the mobile phone stowage compartment, these may be damaged by electromagnetic fields.

- ▶ Do not place credit cards, storage media or other objects sensitive to electromagnetic fields in the mobile phone stowage compartment.

**! NOTE** Damage to the mobile phone stowage compartment caused by liquids

If liquids enter the mobile phone stowage compartment, the compartment may be damaged.

- ▶ Ensure that no liquids enter the mobile phone stowage compartment.

- The charging function is only available when the ignition is switched on.
- In some cases, it may not be possible to charge small mobile phones at every position of the mobile phone receptacle.
- It may not be possible to charge large mobile phones that do not rest in the mobile phone receptacle.
- The mobile phone can warm up during the charging process. This depends on the applications (apps) currently running.
- For more efficient charging, the protective case should be removed from the mobile phone. Protective cases designed for wireless charging are an exception.
- During charging, the mat should be used as far as possible.

## Charging the mobile phone in the front wirelessly

### Requirements:

- The mobile phone must be suitable for wireless charging. A list of compatible mobile phones can be found at:

<http://www.mercedes-benz.com/connect>

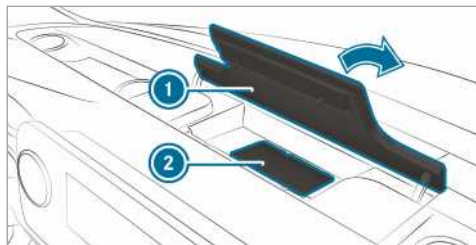

- ▶ Open the flap of stowage compartment ① above the media display.
  - ▶ Place the mobile phone as centrally as possible with the display facing upwards on the marked surface of mat ②.
- When the charging symbol is shown in the multimedia system, the mobile phone is being charged.

Malfunctions during charging are shown in the multimedia system display.

- ⓘ The mat can be removed for cleaning, e.g. with clean, lukewarm water.

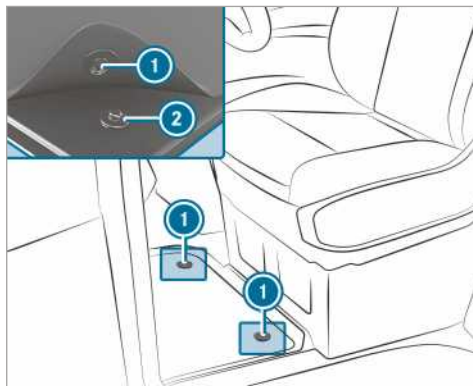

- ▶ **To install:** Press the pushbuttons ① onto the holders ②.

- ▶ **To remove:** Pull the floor mats off the holders ②.

## Fitting or removing the floor mats

### ⚠ WARNING Risk of accident due to objects in the driver's footwell

Objects in the driver's footwell may impede pedal travel or block a depressed pedal.

This jeopardises the operating and road safety of the vehicle.

- ▶ Stow all objects in the vehicle securely so that they cannot get into the driver's footwell.
- ▶ Always fit the floor mats securely and as prescribed in order to ensure that there is always sufficient room for the pedals.
- ▶ Do not use loose floor mats and do not place floor mats on top of one another.



## Exterior lighting

### Changing the lighting on foreign trips

**Vehicles with halogen or static LED headlamps:** Changing the headlamps is not necessary. The statutory requirements are also met in countries where people drive on the other side of the road.

### Light systems and your responsibility

The vehicle's various lighting systems are only aids. The vehicle driver is responsible for adjusting the vehicle's lighting to the prevailing light, visibility, statutory conditions and traffic conditions.

### Light switch

#### Operating the light switch

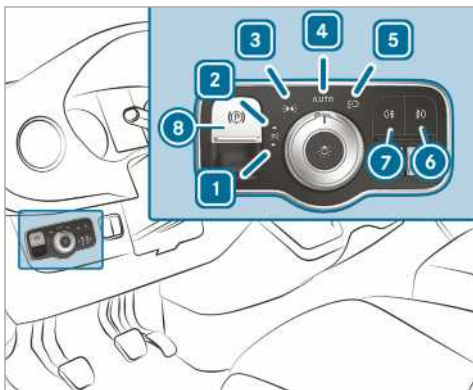

- ▶ 1 Left parking light
- ▶ 2 Right parking light
- ▶ 3 Standing light, license plate and instrument lighting
- ▶ 4 **AUTO** Automatic dipped beam / daytime driving light (preferred light switch position)
- ▶ 5 Dipped beam / main beam
- ▶ 6 Switches fog light on or off
- ▶ 7 Switches rear fog light on or off
- ▶ 8 Electric parking brake (→ page 142)

- ① If you hear a warning tone when exiting the vehicle, the light may still be on.
- ② If you turn on the parking light, there will be a reduced standing light on the selected vehicle side.

The turn signal light, the main beam and the headlamp flasher are operated with the combination switch (→ page 83).

**!** **NOTE** Battery discharging by operating the standing lights

Operating the standing lights over a period of hours puts a strain on the battery.

- ▶ Where possible, switch on the right or left parking light.

In the event of heavy battery discharge, the standing or parking light is automatically switched off for the benefit of the next vehicle start.

#### Automatic dipped beam

**!** **WARNING** Risk of accident when the dipped beam is switched off in poor visibility

When the light switch is set to **AUTO**, the dipped beam may not be switched on automatically if there is fog, snow or other causes of poor visibility such as spray.

- ▶ In such cases, turn the light switch to .

The automatic dipped beam is only an aid. Responsibility for vehicle lighting rests with you. Turn the light switch from **AUTO** to immediately in the event of fog, snow or spray. Otherwise, the dipped beam is temporarily interrupted.

Switching the automatic dipped beam on:

- Turn the light switch to position **AUTO**. Switch the voltage supply on: the standing light automatically switches on or off depending on the surrounding brightness.

The daytime running lights are switched on when the engine is running. The standing light and the dipped beam also switch on or off depending on the surrounding brightness.

When the dipped beam is switched on, the indicator lamp on the instrument cluster switches on.

#### Switching fog light and rear fog light on or off

##### Requirements:

- The light switch is in position or **AUTO**.
- The voltage supply or engine is on.

- ▶ **Switching the fog light on or off:** press the **7** button.
- ▶ **Switching the rear fog light on or off:** press the **6** button.

Comply with the country-specific regulations for using the rear fog light.

### Regulating headlamp range

#### Requirements:

- the engine is running.

You can use the headlamp range controller to adjust the light cone of the headlamps to the vehicle's load condition. As the seats are occupied or the load compartment is loaded or unloaded, the light cone changes. This can cause visibility conditions to deteriorate and you could dazzle oncoming traffic.

- i** In vehicles with LED headlamps, the headlamp range is adjusted automatically.

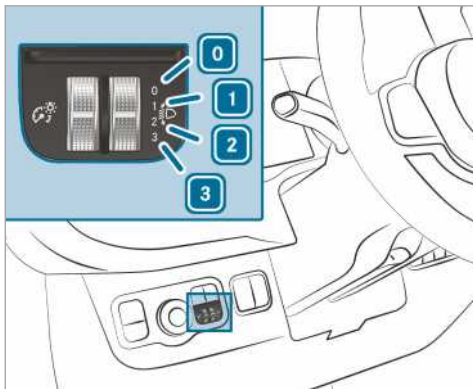

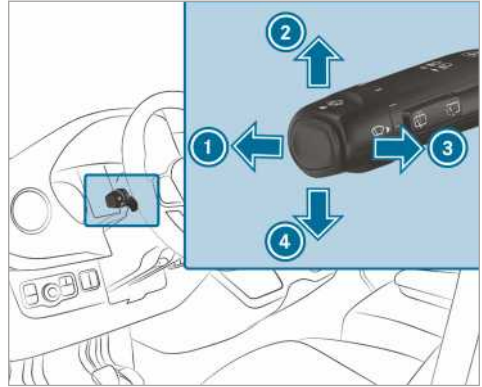

- 0** Driver's and front passenger seat occupied
  - 1** Driver's seat, front passenger seat and rear seats occupied
  - 2** Driver's seat, front passenger seat and rear seats occupied, load compartment or loading area loaded
  - 3** Driver's seat and front passenger seat occupied and using the maximum permitted rear axle load
- ▶ Turn the headlamp range controller to the corresponding position. The road illumination should be 40 m to 100 m and the dipped beam must not dazzle oncoming traffic.
  - ▶ If the vehicle is unloaded, select the **0** position.

### Operating the combination light switch



- 1** High beam
- 2** Right indicator
- 3** Headlamp flasher
- 4** Left indicator

- ▶ **To indicate:** push the combination switch in the required direction **2** or **4** until it engages. In the case of larger steering movements, the combination switch automatically switches back.
- ▶ **To indicate briefly:** tap the combination switch briefly in the required direction **2** or **4**. The corresponding turn signal light flashes three times.
- ▶ **To switch on the high beam:** switch on the dipped beam (→ page 82).
- ▶ Push the combination switch forwards **1**. The indicator lamp  on the instrument cluster will light up. The combination switch will return to its starting position.
- i** The high beam switches to position **AUTO** only in darkness and when the engine is running.
- ▶ **To switch off the main beam:** push the combination switch **1** forwards or briefly pull it in the direction of the arrow **3** (the headlamp flasher switches the main beam off). The indicator lamp  on the instrument cluster will go out. The combination switch will return to its starting position.



**i** Vehicles with Highbeam Assist: when Highbeam Assist is active, it controls the activation and deactivation of the high beam (→ page 84).

▶ **To activate the headlamp flasher:** switch on the power supply or ignition.

▶ Briefly pull the combination switch in the direction of the arrow **3**.

### Switching hazard warning lights on or off

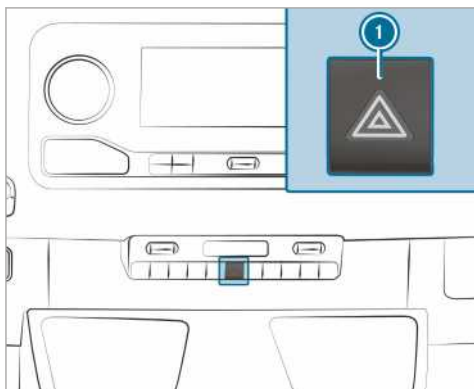

▶ **To switch on and off:** press the **1** button.

If you operate a turn signal while the hazard warning lights are switched on, only the turn signal on the relevant side of the vehicle lights up.

The hazard warning lamps automatically switch on:

- when an airbag is triggered
- in the event of heavy braking from more than 70 km/h until the vehicle comes to a standstill

If the hazard warning lights have automatically switched on, press the hazard warning lamp switch **1** to switch them off.

The hazard warning lamps automatically switch off when the vehicle regains a speed of more than 70 km/h after full brake application.

**i** The hazard warning lights work even when the ignition is switched off.

### Cornering light



Cornering light improves the illumination of the carriageway over a wide angle in the turning direction, enabling better visibility in tight bends, for example.

The function is active:

- at speeds below 40 km/h when the turn signal light is switched on or the steering wheel is turned
- at speeds between 40 km/h and 70 km/h when the steering wheel is turned

The cornering light may still light up for a short time but is switched off automatically after a maximum of three minutes.

**i** When reverse gear is engaged, the lighting switches to the opposite side.

### Highbeam Assist

#### Adaptive Highbeam Assist function

**⚠ WARNING** Risk of accident despite Adaptive Highbeam Assist

Adaptive Highbeam Assist does not recognise the following road users:

- Road users without lights, e.g. pedestrians
- Road users with poor lighting, e.g. cyclists
- Road users whose lighting is obstructed, e.g. by a barrier

On very rare occasions, Adaptive Highbeam Assist may fail to recognise other road users with their own lighting, or may recognise them too late.

In this, or in similar situations, the automatic main beam will not be deactivated or will be activated despite the presence of other road users.

- ▶ Always observe the traffic carefully and switch off the main beam in good time.

Adaptive Highbeam Assist automatically switches between:

- Dipped beam
- High beam

The system detects that vehicle lights are approaching in the opposite direction or driving ahead of the vehicle.

At speeds greater than 30 km/h:

- If no other road users are detected, the high beam switches on automatically.

At speeds below 25 km/h or if there is sufficient road lighting:

- The high beam automatically switches off.

### System limitations

Adaptive Highbeam Assist cannot take the road, weather or traffic conditions into consideration.

Detection may be restricted:

- in poor visibility, e.g. fog, heavy rain or snow
- if there is dirt on the sensors or the sensors are obscured.

Adaptive Highbeam Assist is only an aid. You are responsible for ensuring correct vehicle lighting in accordance with the prevailing light, visibility and traffic conditions.

The system's optical sensor is located behind the windscreen near the overhead control panel.

### Switching Highbeam Assist on or off

- ▶ **To switch on:** turn the light switch to position **AUTO**.
- ▶ Switch the highbeam on using the combination switch.  
If the highbeam is automatically switched on in darkness, the indicator lamp  on the multifunction display lights up.
- ▶ **To switch off:** switch off the highbeam using the combination switch.

### Setting exterior lighting delay time

#### Requirements:

- The light switch is in position **AUTO**.

Multimedia system:

 ▶ Settings ▶ Lights ▶ Exterior light shut-off

- ▶ Setting a lighting delay time.

When the vehicle engine is switched off, the exterior lighting will be activated for the set time.

### Switching surround lighting on/off

Multimedia system:

 ▶ Settings ▶ Lights ▶ Surround lighting

- ▶ Switching a function on or off.



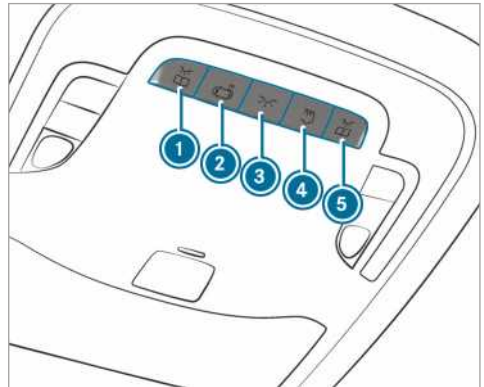

The exterior lighting shines for a period of 40 seconds after unlocking. When you start the vehicle, the surround lighting will be deactivated and the automatic dipped beam activated.

## Adjusting the interior lighting

### Front overhead control panel





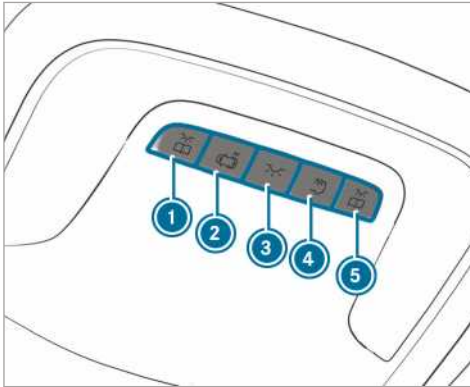

#### Variant 1

- ▶ ①  Switches front left reading lamp on or off
- ▶ ②  Switches automatic interior lighting control on or off
- ▶ ③  Switches front interior lighting on or off
- ▶ ④  Switches rear/load compartment lighting on or off
- ▶ ⑤  Switches front right reading lamp on or off



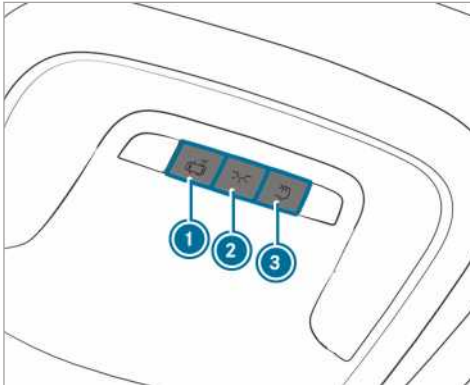

Variant 2

- ▶ ①  Switches front left reading lamp on or off
- ▶ ②  Switches automatic interior lighting control on or off
- ▶ ③  Switches front interior lighting on or off
- ▶ ④  Switches rear/load compartment lighting on or off
- ▶ ⑤  Switches front right reading lamp on or off



Variant 3

- ▶ ①  Switches automatic interior lighting control on or off
- ▶ ②  Switches front interior lighting on or off
- ▶ ③  Switches rear/load compartment lighting on or off

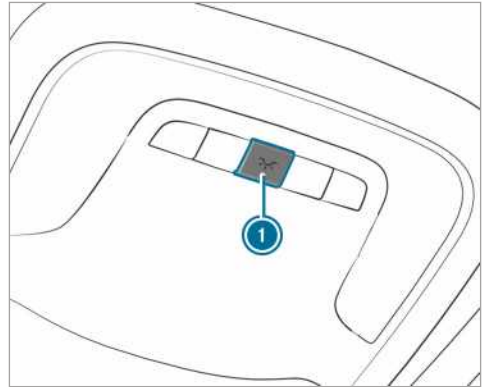

Variant 4

- ▶ ①  Activates/deactivates interior lighting

### Rear interior lighting

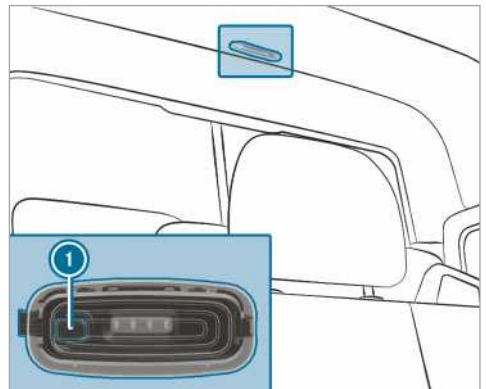

- ▶ ① Switches rear/load compartment lighting on or off

### Motion detector

**⚠ WARNING** Risk of injury by laser beam from motion detector

The motion detector transmits invisible radiation from LEDs (light-emitting diodes).

These LEDs are classified under the 1M laser class and can cause retina damage in the following situations:

- If you look directly into the unfiltered laser beam from the motion detector for an extended period
  - If you look directly into the laser beam of the motion detector with optical instruments such as spectacles or a magnifying glass.
- ▶ Never look directly into the laser beam.

The motion detector is located in the cargo compartment behind the partition in the middle of the roof.

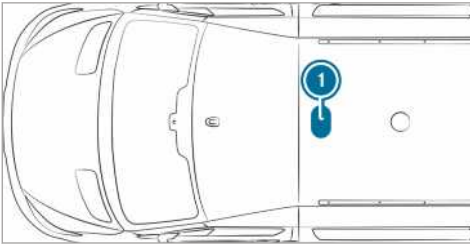

#### ① Position of motion detector

If the vehicle is equipped with a motion detector, the cargo compartment lighting is also activated via the motion detector.

If the motion detector detects movement in the cargo compartment while the vehicle is stationary, the cargo compartment lighting will switch on for approximately two minutes.

The cargo compartment lighting can be switched on via the motion detector if

- the vehicle is stationary, the parking brake is applied and you are not depressing the brake pedal
- in vehicles with automatic transmissions, the selector lever is in position **P** and you are not depressing the brake pedal
- the vehicle has not been locked with the key from the outside

If no change to the vehicle, such as a door opening, is detected over several hours, the motion detector will automatically switch off. This prevents the battery from discharging.

## Switching interior lighting delay time on/off

Multimedia system:

→ ▶ Settings ▶ Lights ▶ Interior light shut-off

- ▶ Switching the lighting delay time on and off.

## Changing bulbs

### Instructions for changing bulbs

**⚠ WARNING** Risk of burns from hot component parts whilst replacing a bulb

Bulbs, lamps and plug connectors can become very hot during operation.

When replacing a bulb, you could burn yourself on these component parts.

- ▶ Allow the component parts to cool down before replacing the bulbs.

- Do not use any bulb that has been dropped or has scratches on its glass tube. Otherwise, the bulb may explode.
- The bulb may explode if you touch it, if it is hot, if you drop it or if you scratch it.
- Stains on the glass tube reduce the bulb's service life. Do not touch the glass tube with your bare hands. If necessary, clean the glass tube with alcohol or spirits in a cold state and wipe it down with a lint-free cloth.
- Protect bulbs from humidity and do not bring them into contact with liquids.

Always ensure the bulbs are firmly secured.

If your vehicle is equipped with LED lamps, you can check this as follows: the light cone will move from top to bottom and back again when the engine starts. For this to work, the dipped beam needs to have been switched on before the engine is started.

Bulbs and lights are a major element in vehicle safety. Therefore, ensure that they are always working. Have the headlamp setting checked regularly.

- Before changing the lamps, switch off the vehicle's lighting system. You can thus avoid a short circuit.
- Use bulbs only in closed lights that have been designed for them.
- Use only spare bulbs of the same type and with the correct voltage.

If the new bulb also does not light up, consult a qualified specialist workshop.

### Replacing front light bulbs (vehicles with halogen headlamps)

#### Overview of front bulb types

You can change the following bulbs.

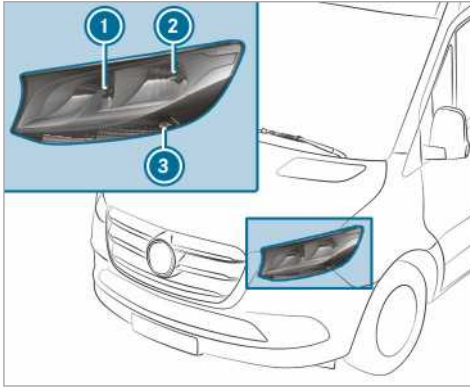

Halogen headlamps

- ① Main beam/daytime running lights: H15 55 W/15 W
- ② Dipped beam/perimeter light: H7 55 W/W 5 W
- ③ Indicators: PY 21 W

#### Changing the halogen headlamp

##### Requirements:

- **Dipped beam:** light bulb type H7 55 W
- **High beam/daytime running lights:** light bulb type H15 55 W/15 W
- **Perimeter lights:** light bulb type W 5 W
- **Indicators:** bulb type PY 21 W

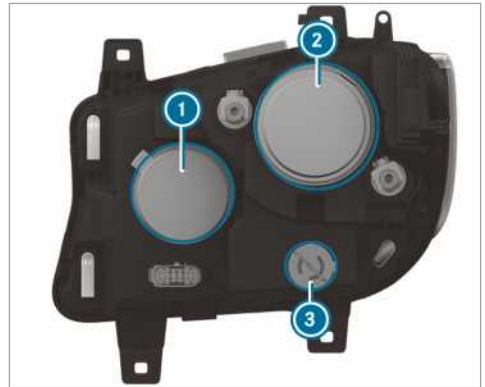

- ① High beam/daytime running lights housing cover
- ② Dipped beam/perimeter lights housing cover
- ③ Indicator socket

- ▶ Switch off the lighting system.
- ▶ **High beam/daytime running lights:** pull back the housing cover ①.
- ▶ Turn the socket anti-clockwise and pull it out.
- ▶ Remove the bulb from the socket.
- ▶ Insert the new bulb into the socket such that the base of the bulb rests fully against the base of the socket.
- ▶ Insert the socket and turn it clockwise.
- ▶ Attach the housing cover ①.
- ▶ **Dipped beam/perimeter lights:** pull back the housing cover ②.
- ▶ Pull out the socket towards the rear.
- ▶ Remove the bulb from the socket.
- ▶ Insert the new bulb into the socket such that the base of the bulb rests fully against the base of the socket.
- ▶ Align and insert the socket.
- ▶ Attach the housing cover ②.
- ▶ **Indicator:** switch off the lighting system.
- ▶ Turn the socket ③ anti-clockwise and remove it.
- ▶ Gently turn the bulb anti-clockwise and take it out of the socket.
- ▶ Insert the new bulb into the socket and turn it clockwise.
- ▶ Insert the socket ③ and turn it clockwise.

## Additional turn signal light

### Requirements:

- **Additional turn signal light (all-wheel drive vehicles):** bulb type P 21 W

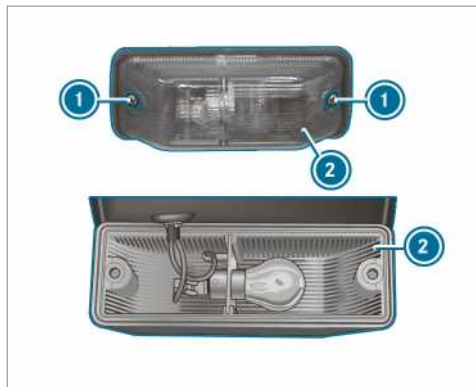

- ▶ Switching off the lighting system.
- ▶ Unscrew the screws ① and remove the light lens ②.
- ▶ Gently turn the bulb to the left and take it out of the socket.
- ▶ Insert the new bulb into the socket and turn it to the right.
- ▶ Place the light lens ② in position and tighten the screws ①.

## Replacing rear light bulbs (panel vans and crewbuses)

### Overview of rear bulb types (panel van and crewbus)

You can change the following bulbs.

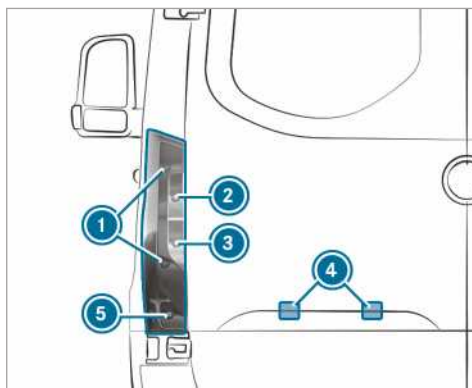

Vehicles with standard tail lamps

- ① Brake lights/tail lamps/perimeter lights: P 21 W
- ② Indicators: PY 21 W
- ③ Reversing lights: P 21 W
- ④ Licence plate lighting: W 5 W
- ⑤ Rear fog lights: P 21 W

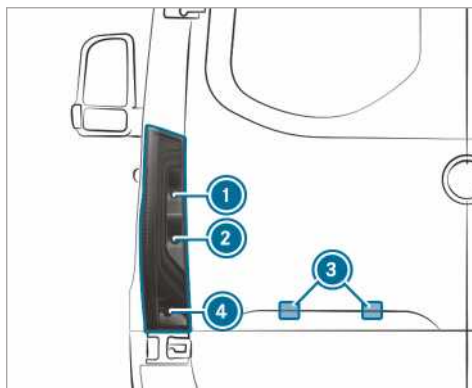

Vehicles with partial LED tail lamps

- ① Indicators: PY 21 W
- ② Reversing lights: P 21 W
- ③ Licence plate lighting: W 5 W
- ④ Rear fog lights: P 21 W

## Tail lamps (panel van and crewbus)

### Requirements:

- **Brake lights/tail lamps/perimeter lights:** light bulb type P 21 W
- **Indicators:** bulb type PY 21 W
- **Rear fog lights:** bulb type P 21 W

• **Reversing lights:** bulb type P 21 W

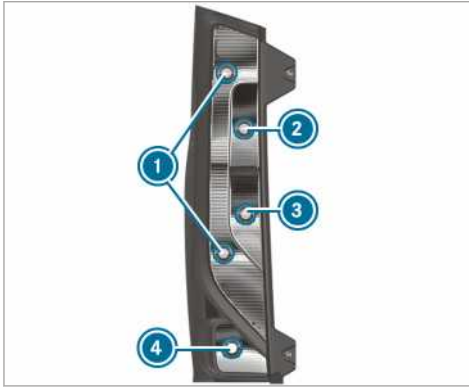

- ① Brake lights/tail lamps/perimeter lights
- ② Indicator
- ③ Reversing light
- ④ Rear fog light

- ▶ Switch off the lighting system.
- ▶ Open the rear door.

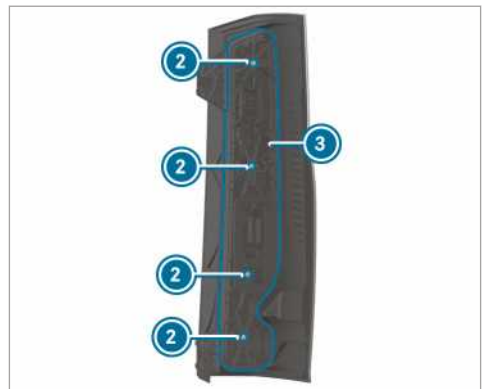
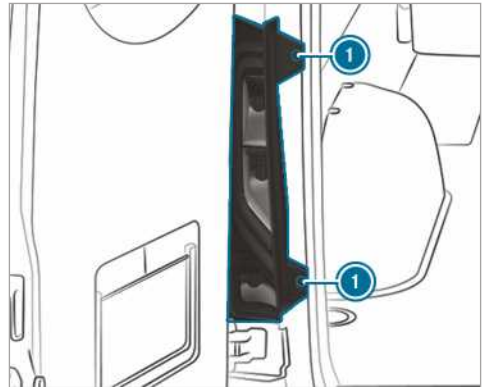

- ▶ **To remove:** loosen the screws ① and pull out the tail lamps.
- ▶ Remove the connector from the bulb mount ③.
- ▶ Loosen the screws ② and remove the bulb mount ③ from the tail lamp.
- ▶ Gently turn the bulb anti-clockwise and take it out of the socket.
- ▶ Insert the new bulb into the socket and turn it clockwise.
- ▶ **To install:** set the bulb mount ③ on the tail lamp and screw in the screws ②.
- ▶ Press the connector into the bulb mount ③.
- ▶ Insert the tail lamp and screw in the screws ①.

**Licence plate lighting**

**Requirements:**

- **Licence plate lighting:** light bulb type W 5 W



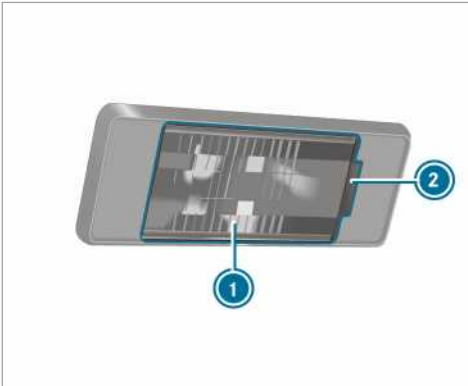

- ▶ Switch off the lighting system.
- ▶ Place a screwdriver, for example, at the opening ② and carefully lever off the lamp lens ①.
- ▶ Remove the bulb from the socket.
- ▶ Insert the new bulb into the socket.
- ▶ Position the lamp lens and clip it in so that it engages.

### Replacing rear light bulbs (chassis)

#### Overview of rear bulb types (chassis)

You can change the following bulbs.

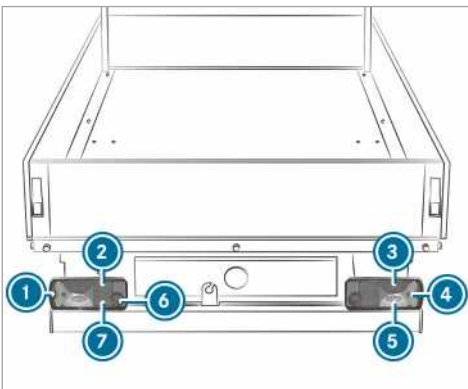

Vehicles with standard tail lamps

- ① Clearance lamp: R 5 W
- ② Tail light: R 5 W
- ③ Brake light: P 21 W
- ④ Indicators: PY 21 W
- ⑤ Reversing lights: P 21 W

- ⑥ Rear fog light (driver's side): P 21 W
- ⑦ Licence plate lighting: R 5 W

#### Tail lamp (chassis)

##### Requirements:

- **Clearance lamp:** bulb type R 5 W
- **Indicators:** bulb type PY 21 W
- **Brake light:** bulb type P 21 W
- **Taillight:** bulb type R 5 W
- **Rear fog lights:** bulb type P 21 W
- **License plate lighting:** bulb type R 5 W
- **Reversing lights:** bulb type P 21 W

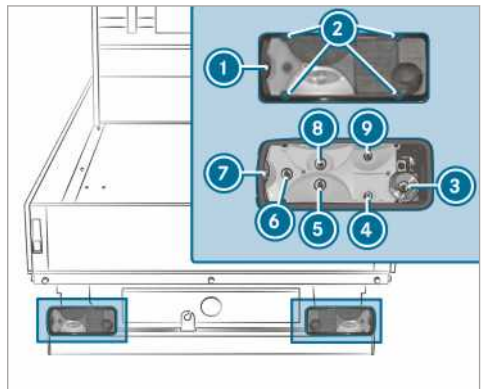

- ① Light lens
- ② Screws
- ③ Clearance lamp
- ④ Indicator
- ⑤ Brake light
- ⑥ Taillight
- ⑦ Rear fog light
- ⑧ Licence plate lighting
- ⑨ Reversing light

- ▶ Switch off the lighting system.
- ▶ Unscrew the screws ① and remove the light lens ②.
- ▶ Remove the plug connector from the lamp carrier.
- ▶ Gently turn the bulb anti-clockwise and take it out of the socket.
- ▶ Insert the new bulb into the socket and turn it clockwise.
- ▶ Position the light lens ② and tighten the screws ①.



## Replacing bulbs in additional lamps

### Side marker lamps

#### Requirements:

- **Side marker lamps:** light bulb type LED

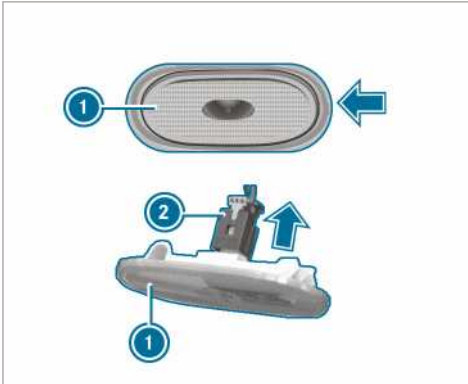

- ▶ Switch off the lighting system.
- ▶ Position a screwdriver, for example, at the side and carefully lever off side marker lamp ① in the direction of the arrow.
- ▶ Remove plug ② from side marker lamp ① in the direction of the arrow.
- ▶ Connect the new side marker lamp with the plug.
- ▶ Position the side marker lamp on the left and press in. The side marker lamp engages audibly.

## Replacing interior light bulbs

### Bulbs for rear interior lamps

#### Requirements:

- ① For the standard bulb failure indicator function to work correctly, only lights bulbs must be used that are the same type and power as those installed during production.

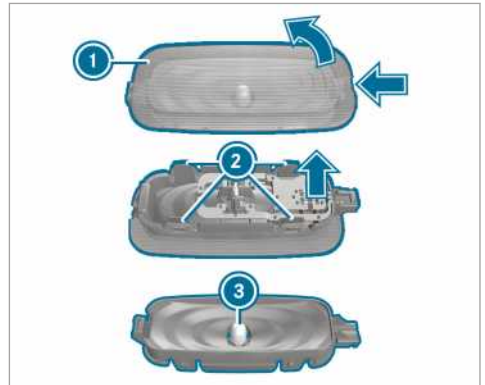

- ▶ Switch off the interior lighting.
- ▶ Press in the catch spring of lens ① with a suitable object e.g. a screwdriver, and then lever off the lens with the lamp housing.
- ▶ **To pull back lens from the lamp housing:** press the lugs of the lens ② inwards.
- ▶ Remove light bulb ③ from the lamp housing.
- ▶ Insert the new light bulb.
- ▶ Insert the lens in the lamp housing until it engages.
- ▶ Place the lens with the lamp housing in position until it engages.

## Windscreen wipers

### Switching the windscreen wipers on/off

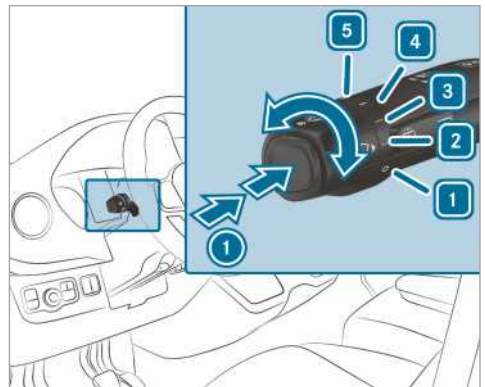



- ① Single wipe/wiping with washer fluid
- 1 0 Windscreen wipers off
- 2 ... Intermittent wiping, normal

Vehicles with rain sensors: automatic wiping, normal

- 3  Intermittent wiping, frequent



Vehicles with rain sensors: automatic wiping, frequent

- 4  Continuous wiping, slow

- 5  Continuous wiping, fast



▶ Turn the combination switch to the corresponding position 1 - 5.

▶ **Single wipe/washing:** press the button on the combination switch in the direction of arrow 1.

-  Single wipe
-  Wiping with washer fluid

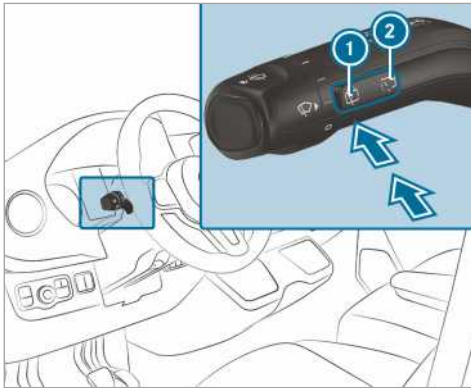
### Switching the rear window wiper on/off



- 1  Single wipe/wash
- 2  Intermittent wiping

▶ **Single wipe:** press button 1 to the point of resistance.

▶ **Wiping with washer fluid:** press button 1 beyond the point of resistance.

▶ **To switch intermittent wiping on or off:** press button 2.

If the rear window wiper is switched on, the  symbol appears on the instrument display.

### Replacing the windscreen wiper blades

**⚠ WARNING** Risk of becoming trapped if the windscreen wipers are switched on while wiper blades are being replaced

If the windscreen wipers begin to move while you are changing the wiper blades, you can be trapped by the wiper arm.

▶ Always switch off the windscreen wipers and ignition before changing the wiper blades.

**⚠ WARNING** Risk of injury from using the windscreen wipers while the engine bonnet is open

When the engine bonnet is open, and the windscreen wipers are set in motion, you can be trapped by the wiper linkage.

▶ Always switch off the windscreen wipers and ignition before opening the engine bonnet.

**i** If the wiper blades are worn out, they will not wipe the windscreen properly. Replace the wiper blades twice a year, preferably in spring and autumn.

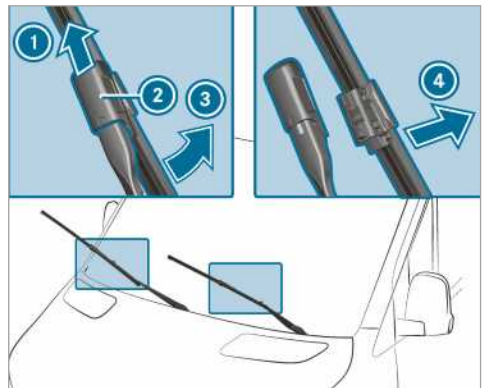

- ▶ Fold wiper arm 3 away from the windscreen.
- ▶ Hold wiper arm 3 and turn the wiper blade away from wiper arm 3 in the direction of the arrow as far as it will go.
- ▶ Slide catch 2 upwards in the direction of the arrow until it engages.
- ▶ Fold back the wiper blade on the wiper arm.
- ▶ Remove the wiper blade from wiper arm 1.

- ▶ Insert new washer blade ① in the holder on wiper arm ③.

When doing so, take into account the different lengths of the wiper blades:

- Driver's side: long wiper blade
- Front passenger side: short wiper blade

- ▶ Slide catch ② downwards until it engages.
- ▶ Fold wiper arm ③ back onto the windscreen.

### Replacing the windscreen wiper blades (WET WIPER SYSTEM)

**▲ WARNING** Risk of becoming trapped if the windscreen wipers are switched on while wiper blades are being replaced

If the windscreen wipers begin to move while you are changing the wiper blades, you can be trapped by the wiper arm.

- ▶ Always switch off the windscreen wipers and ignition before changing the wiper blades.

**▲ WARNING** Risk of injury from using the windscreen wipers while the engine bonnet is open

When the engine bonnet is open, and the windscreen wipers are set in motion, you can be trapped by the wiper linkage.

- ▶ Always switch off the windscreen wipers and ignition before opening the engine bonnet.

- ① If the wiper blades are worn out, they will not wipe the windscreen properly. Replace the wiper blades twice a year, preferably in spring and autumn.

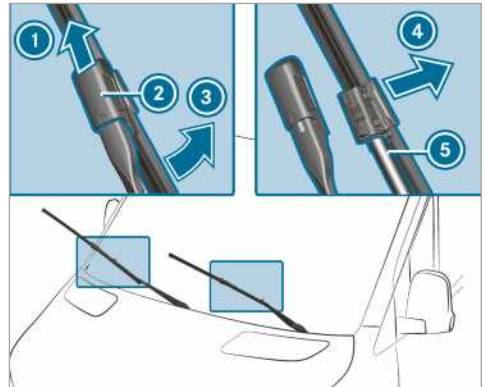

- ▶ Fold wiper arm ③ away from the windscreen.
- ▶ Hold wiper arm ③ and turn the wiper blade away from wiper arm ③ in the direction of the arrow as far as it will go.
- ▶ Slide catch ② upwards in the direction of the arrow until it engages.
- ▶ Remove wiper blade ① from the wiper arm in the direction of arrow ④.
- ▶ Carefully remove hose ⑤ from the wiper blade.
- ▶ Attach hose ⑤ to the new wiper blade.
- ▶ Insert new washer blade ① in the holder on wiper arm ③.

When doing so, take into account the different lengths of the wiper blades:

- Driver's side: long wiper blade
- Front passenger side: short wiper blade
- ▶ Slide catch ② downwards until it engages.
- ▶ Fold back the wiper blade on the wiper arm.
- ▶ Fold wiper arm ③ back onto the windscreen.

## Replacing the rear window wiper blade

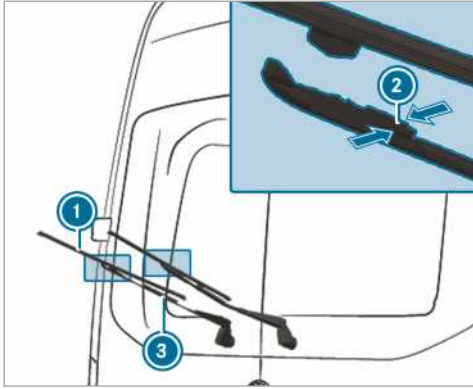

- ▶ Fold wiper arm ③ away from the rear window.
- ▶ Press both retaining clips ② in the direction of the arrow and swivel the wiper blade away from the wiper arm.
- ▶ Pull wiper blade ① upwards out of the holder on wiper arm ③.
- ▶ Insert new wiper blade ① into the holder on wiper arm ③.
- ▶ Push the new wiper blade ① onto the wiper arm ③ until the retaining clips engage.
- ▶ Fold the wiper arm ③ back onto the rear window.

## Mirrors

### Operating the outside mirrors

- ⚠ **WARNING** Risk of injury through adjusting vehicle settings while the vehicle is in motion

You could lose control of the vehicle in the following situations:

- if you adjust the driver's seat, the head restraints, the steering wheel or the mirror while the vehicle is in motion
- if you fasten your seat belt while the vehicle is in motion
- ▶ Before starting the engine: adjust the driver's seat, the head restraints, the steering wheel or the mirror and fasten your seat belt.

- ⚠ **WARNING** Risk of accident due to misjudgement of distances when using the outside mirror

The outside mirrors reflect objects on a smaller scale. The objects in view are in fact closer than they appear.

As a result, you may misjudge the distance between you and the road user driving behind you, e.g. when changing lanes.

- ▶ Therefore, always look over your shoulder in order to ensure that you are aware of the actual distance between you and the road users driving behind you.

### Adjusting the outside mirrors manually

- ▶ Adjust the outside mirrors to the correct position manually.
- ▶ **To engage an outside mirror that has been pushed out of position:** push the outside mirror into position manually.

### Adjusting the outside mirrors electrically

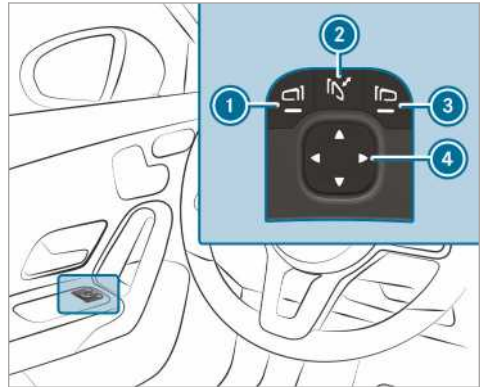

Example image

- ⚠ **NOTE** Damage to the electric outside mirrors

If you fold the electric outside mirrors in or out manually, you may damage the outside mirrors and they will not lock in place properly.

If the outside mirrors are not folded in when washing the vehicle in a car wash, the washer brushes may fold them in forcibly and damage them.

- ▶ The outside mirrors must only be folded in and out electrically.
- ▶ Fold the outside mirrors in before washing the vehicle in a car wash.

- ▶ Before driving off, switch on the power supply or the ignition.
- ▶ **To fold in or out:** briefly press button ②.
- ▶ **To adjust:** use button ① or ③ to select the outside mirror to be adjusted.
- ▶ Set the position of the mirror glass by pressing button ④.
- ▶ **To engage an outside mirror that has been pushed out of position:** press and hold button ②.  
You will hear a click and the mirror will audibly engage in position. The outside mirror is set in the correct position.

### Heating the outside mirrors

- ▶ **Vehicles without a rear window heater:** at low temperatures, the mirror heating switches on automatically when the engine is started.
- ▶ **Vehicles with a rear window heater:** at low temperatures, the mirror heater switches on automatically when the engine is started. The mirror heater can also be switched on together with the rear window heater using the rear window heater button.

### Dimming the inside rearview mirror

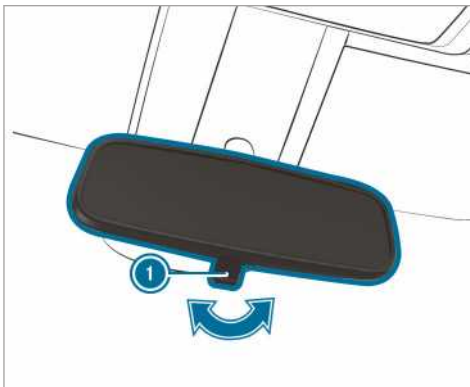

- ▶ **To dim the inside rearview mirror:** move anti-dazzle lever ① in the direction of the arrow.

### Operating sun visors

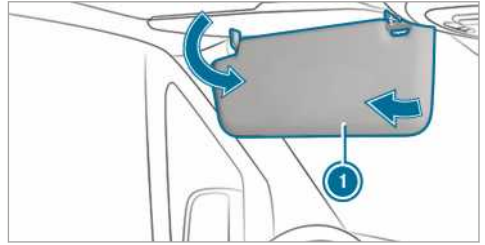





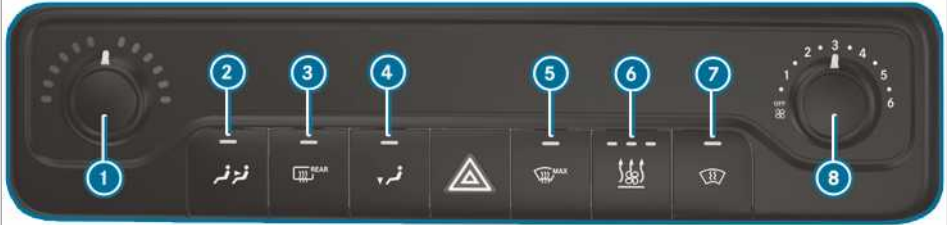

- ▶ **Glare from front:** Fold the sun visor ① downwards.
- ▶ **Glare from the side:** Swivel the sun visor ② to the side.

## Overview of climate control systems

### Heating system



- ① Sets the temperature
- ②  Switches the rear-compartment heating on or off
- ③  Switches the rear window heater on or off (→ page 102)
- ④  Switches footwell air distribution on or off
- ⑤  Activates/deactivates the windscreen defroster (→ page 101)
- ⑥ Vehicles with stationary heaters or heater boosters:  switches the stationary heater or heater booster on and off (→ page 104)
- ⑦  switches the windscreen heater on or off (→ page 102)
- ⑧ Sets the airflow

⑦









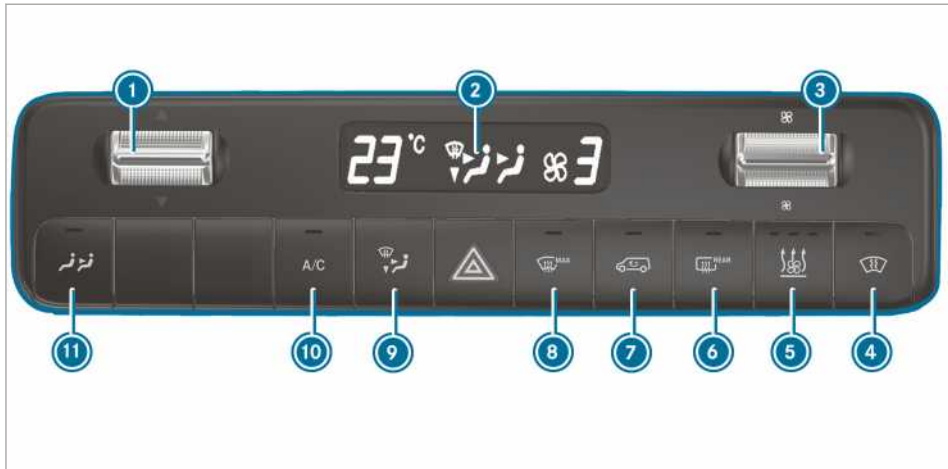

Vehicles with windscreen heaters:

- ① The indicator lamps on the buttons signal that the function in question has been activated.

TEMPMATIC



- ① ▼▲ Sets the temperature
- ② Display
- ③  Sets the airflow
- ④  Vehicles with a windscreen heater: switches the windscreen heater on or off (→ page 102)
- ⑤ Vehicles with auxiliary heating or heater boosters:  switches the auxiliary heating or heater booster on or off (→ page 104)
- ⑥ Vehicles with a rear window heater:  switches the rear window heater on or off (→ page 102)
- ⑦  Switches air-recirculation mode on or off (→ page 101)
- ⑧  Activates/deactivates windscreen defroster (→ page 101)
- ⑨  Adjusts the air distribution (→ page 101)
- ⑩  Switches the A/C function on or off (→ page 100)
- ⑪  Vehicles with dual-zone climate control systems: adjusts the rear-compartment climate control/heater (indicator lamp flashes) (→ page 100)

i The indicator lamps on the buttons signal that the function in question has been activated.

## THERMOTRONIC

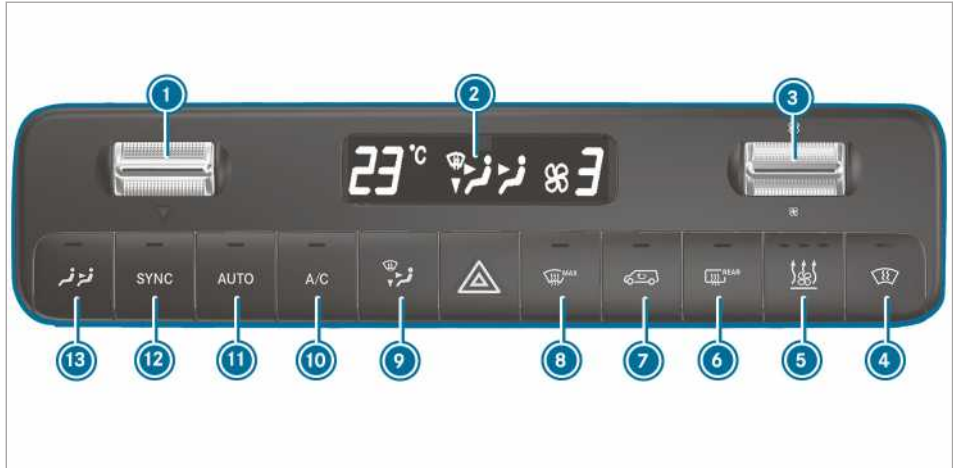

1 ▼▲ Sets the temperature

2 Display

3  Sets the airflow

4





Vehicles with a windscreen heater: switches the windscreen heater on or off (→ page 102)

5 Vehicles with auxiliary heating or heater boosters:  switches the auxiliary

heating or heater booster on or off (→ page 104)

6 Vehicles with a rear window heater:  switches the rear window heater on or off (→ page 102)

7  Switches air-recirculation mode on or off (→ page 101)

8  Activates/deactivates windscreen defroster (→ page 101)

9  Adjusts the air distribution (→ page 101)

10  Switches the A/C function on or off (→ page 100)

11  Automatically controlling the climate control, front (→ page 100) and rear (→ page 100)

12  Activates or deactivates synchronisation (→ page 101)

13  Vehicles with dual-zone climate control systems: adjusts the rear-compartment climate control/heater (indicator lamp flashes) (→ page 100)

i The indicator lamps on the buttons signal that the function in question has been activated.

Switch the climate control system off only briefly.

i If the front-compartment system has already been switched on and the rear-compartment system has been switched off, you can switch it on by turning up the fan on the rear-compartment menu. If the front-compartment system is switched on, the rear-compartment system will automatically switch on as well.

## Operating climate control systems

### Switching the climate control system on/off

▶ **To switch on:** set the airflow to 1 or higher on the front-compartment menu.

▶ **To switch off:** set the airflow to 0 or **OFF** on the front-compartment menu. **OFF** appears on the climate control system display.

i When the climate control system is switched off, the windows may mist up more quickly.





## Adjusting the rear-compartment climate control



### Requirements:

- The climate control system has been switched on (→ page 99).

### Switching on the temperature and airflow and adjusting TEMP/MATIC and THERMOTRONIC

- ▶ Press the  button.  
The indicator lamp on the  button and the  symbol on the climate control system display flash.

The display switches to the temperature and the blower in the rear menu.



- ▶ Use rocker switches  and  to set the required temperature and airflow on the rear-compartment menu.

- ⓘ If there are significant differences between the temperature settings of the front and rear systems, these cannot be controlled accurately.
- ⓘ If the rear-compartment climate control has been switched off, you can switch it on automatically by pressing the  button.

Depending on the vehicle equipment, climate control switches on the overhead air-conditioning system or rear-compartment heating as required:

- **Vehicles with an overhead air-conditioning system:** the rear compartment can be cooled only.
- **Vehicles with rear-compartment heating:** the rear compartment can be heated only.

### Switching off TEMP/MATIC and THERMOTRONIC rear-compartment climate control

- ▶ Press the  button.
- ▶ If the indicator lamp on the  button and the  symbol on the climate control system display flash, set the airflow to 0 on the rear-compartment menu.
- ⓘ Indicator lamp on: rear-compartment climate control has been switched on.  
Indicator lamp off: rear-compartment climate control has been switched off.  
Indicator lamp flashes: the setting mode of the rear-compartment climate control is active.

## Switching the A/C function on and off

### Requirements:

- The climate control system is switched on. (→ page 99)

The A/C function controls the climate and dries the air inside the vehicle.

- ▶ Press the  button.
- ⓘ Switch the A/C function off only temporarily. Otherwise, the windows may mist up more quickly.
- ⓘ Condensation may leak from the underside of the vehicle in cooling mode. This is not a sign of a defect.

## Automatically regulating climate control

### Requirements:

- The climate control system is switched on. (→ page 99)

### Switching on automatic climate control

In automatic mode, the temperature, airflow and air distribution are regulated and kept constant.

- ▶ Press the  button.  
The temperature is shown on the display. The airflow and air distribution disappear from the display.

If the rear-compartment climate control has been switched on, the setting for the rear is carried over.

### Switching off automatic climate control



- ▶ Use the rocker switch  to change the airflow setting and air distribution (→ page 101).  
The other setting remains unaffected by the change.

## Automatically controlling the climate control in the rear

### Requirements:

- Rear-compartment climate control has been switched on (→ page 100).

In automatic mode, the temperature, airflow and air distribution are regulated and kept constant.





- ▶ Press the  button.
- ▶ Press the  button.

- ❗ Even if the front-compartment system is in automatic mode, the rear-compartment system can exit automatic mode if you adjust the fan on the rear-compartment menu.
- ❗ If the air is cooled and the driver, front passenger or sliding door is opened, the rear air conditioning system blower is turned down after around 15 minutes. When all doors have been closed again, the blower is reset to the previous setting after around one minute.

## Air distribution settings

The symbols on the display indicate the vents through which the air is being directed.

### TEMPMATIC

-  Defroster and centre vents
-  All vents
-  Centre vents
-  Centre and footwell vents

### THERMOTRONIC

-  Defroster vents
-  Defroster and centre vents
-  All vents
-  Defroster and footwell vents
-  Centre vents
-  Centre and footwell vents
-  Footwell vents

## Setting the air distribution

### Requirements:

- The climate control system is switched on.

- ▶ Press the  button repeatedly until the desired air distribution appears in the air conditioning system display.

## Switching the synchronisation function on and off

### Requirements:

- The climate control system is switched on. (→ page 99)





The synchronisation function controls the climate control function centrally. The settings for the temperature and airflow in the front zone are automatically adopted for the rear zone.

- ▶ Press the  button.

- ❗ If the rear-compartment climate control has been switched off, you can switch it on automatically by pressing the  button.

## Demisting the windows

### Misting on the insides of windows

- ▶ Press the  button and, if necessary, use the  button to direct the air onto the windscreen .
- ▶ If the windows remain misted up: press the  button. When the windscreen defroster is switched on, the temperature and airflow cannot be adjusted.

Vehicles with TEMPMATIC or THERMOTRONIC: the display is off.

or

- ▶  button.

### Misting on the outsides of windows

- ▶ Switch on the windscreen wipers (→ page 92).

## Switching air-recirculation mode on and off

- ▶ Press the  button. The interior air is recirculated.

The air-recirculation mode switches off automatically.



- ❗ When air-recirculation mode is switched off, the windows may mist up more quickly. Switch on air-recirculation mode only briefly.

Air-recirculation mode automatically switches on in the following cases:

- at high outside temperatures
- when the vehicle is driving through a tunnel (vehicles with THERMOTRONIC automatic climate control and navigation only)
- when the windscreen wipers are switched on (→ page 92)

The indicator lamp on the  button does not light up in this case. After maximum 30 minutes, outside air is automatically introduced again.

### Convenience opening/closing via the air recirculation button

- ▶ **Convenience closing:** press the  button until the side windows begin to close automatically.  
The initial position of the side windows is saved.
- ▶ **Convenience opening:** press the  button until the side windows begin to open automatically.  
The side windows open automatically until they have reached their previously saved position.

### Switching the windscreen heater on and off

- ⓘ In the event of high outside temperatures, the windscreen heater may not turn on.
- ▶ Press the button for the windscreen heater.  
If the indicator lamp lights up, the windscreen heater is switched on.
- ⓘ The windscreen heater switches off automatically after a few minutes.
- ⓘ If the battery voltage is too low, it may not be possible to switch the windscreen heater on. If the battery voltage becomes too low while the windscreen heater is in operation, the windscreen heater will switch off automatically.

### Switching the rear window heater on and off

- ▶ Press the  button.  
If the indicator lamp lights up, the rear window heater is switched on.

### Operating air vents

#### Adjusting the front-compartment air vents

**▲ WARNING** - Risk of burns/frostbite due to not maintaining a sufficient distance to the air vents

Very hot or very cold air can flow from the air vents.

This could result in burns or frostbite in the immediate vicinity of the air vents.

- ▶ Always ensure that all vehicle occupants maintain a sufficient distance to the air vents.

- ▶ If necessary, redirect the airflow to another area of the vehicle interior.

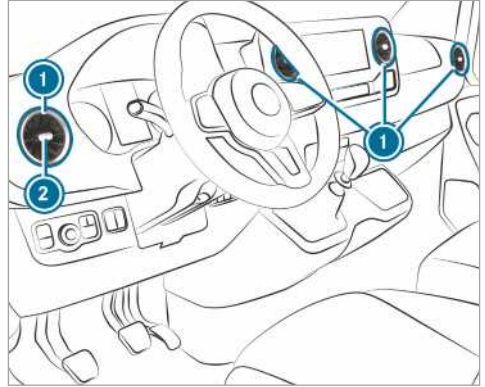

- ▶ **To open or close:** hold the centre **2** of the air vent **1** and turn it to the left or right as far as it will go.
- ▶ **To set the air direction:** hold the centre **2** of the air vent **1** and swivel it upwards, downwards, to the left or to the right.

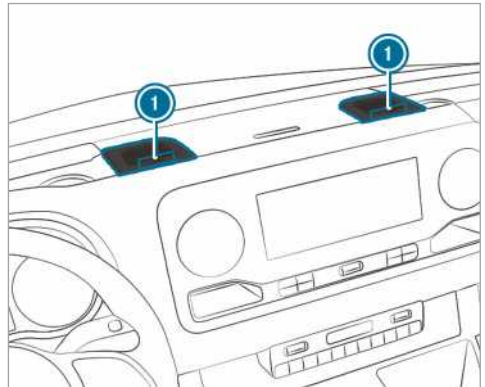

- ▶ **To open or close:** turn the adjustment wheels **1** on the high-power air vents to the left or right as far as they will go.
- ⓘ Cooled air will flow out of the high-power air vents. Heating will not be possible. Open the high-power air vents only in summer during cooling mode and keep them closed in winter.

## Adjusting air vents in the roof air duct

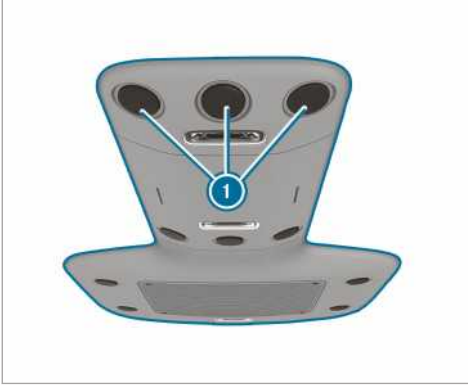

In vehicles with rear-compartment air conditioning, adjustable air vents have been integrated in the roof air duct.

- ▶ **Adjusting the airflow:** if necessary, open or close the air flaps in the air vents ①.
- ▶ **Adjusting the air distribution:** turn the air vents ① to the required position.

## Ventilation nozzles in the rear

**⚠ WARNING** - Risk of burns/frostbite due to not maintaining a sufficient distance to the air vents

Very hot or very cold air can flow from the air vents.

This could result in burns or frostbite in the immediate vicinity of the air vents.

- ▶ Always ensure that all vehicle occupants maintain a sufficient distance to the air vents.
- ▶ If necessary, redirect the airflow to another area of the vehicle interior.

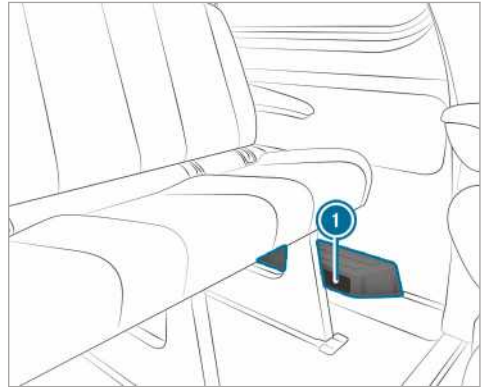

Depending on the vehicle equipment, there will be an air duct or a heater with additional air nozzles in the rear footwell on the left-hand side ①. No objects must be placed there. Passengers must maintain a sufficient distance due to the warm air flow and air intake.

## Auxiliary heating

### Function of the auxiliary heating

**⚠ DANGER** Risk of fatal injury due to poisonous exhaust gases

If the tailpipe is blocked or sufficient ventilation is not possible, poisonous exhaust gases such as carbon monoxide may enter the vehicle. This is the case in enclosed spaces or if the vehicle gets stuck in snow, for example.

- ▶ Always switch the stationary heater off in enclosed spaces without an air extraction systems, e.g. in garages.
- ▶ Keep the tailpipe and the area around the vehicle free from snow when the engine or the stationary heater are running.
- ▶ Open a window on the windward side of the vehicle to ensure an adequate supply of fresh air.

**⚠ WARNING** Risk of fire due to hot stationary heater components

When the stationary heater is switched on, parts of the vehicle can become very hot, e.g. the stationary heater exhaust system.

Flammable materials such as leaves, grass or twigs may ignite if they come into contact with:

- hot parts of the stationary heater exhaust system
  - the exhaust gas itself
- ▶ When the stationary heater is switched on, make sure that:
- hot vehicle parts do not come into contact with flammable materials.
  - the exhaust gas can flow out of the stationary heater tailpipe unhindered.
  - the exhaust gas does not come into contact with flammable materials.

#### **I** NOTE Damage to the auxiliary heating

If the auxiliary heating is not used for an extended period of time, it can be damaged.

- ▶ Switch the auxiliary heating on for around ten minutes at least once a month.

#### **I** NOTE Damage to the auxiliary heating due to overheating

If the hot air flow is blocked, the auxiliary heating can overheat and switch off.

- ▶ Do not block the hot air flow.

**i** **Vehicles with modified fuel gauges:** if an externally operated consumer is connected via the cable for the auxiliary heater, this is not taken into consideration on the "range remaining" display of the on-board computer. In this case, observe the fuel gauge. The fuel gauge provides the current level.

When transporting dangerous goods, comply with the relevant safety regulations. Always place objects at a sufficient distance from the outlet opening of the auxiliary heating.

Auxiliary heating works independently of the engine and complements the climate control system in the vehicle. Auxiliary heating heats the air inside the vehicle to the set temperature.

## Hot-water auxiliary heater

### Function of the hot-water auxiliary heater

The hot-water auxiliary heater complements your vehicle's climate control system, and has a

heater booster, auxiliary heating and auxiliary ventilation function. In addition, the auxiliary heating system heats the engine coolant to protect the engine and save fuel during the warming-up phase. The auxiliary heating heats the air inside the vehicle to the set temperature. It is not dependent on the heat output of the running engine. The auxiliary heating is operated directly using the vehicle's fuel. For this reason, the fuel tank must have been filled above the reserve fuel level so that the auxiliary heating can work. The auxiliary heating automatically adapts its operating mode to the outside temperature and weather. It is therefore possible that the auxiliary heating may switch from ventilation to heating mode or from heating to ventilation mode. When the engine is running, auxiliary ventilation is not active. Auxiliary heating automatically switches itself off after a maximum of 50 minutes. You cannot use the "auxiliary ventilation" operating mode to cool the air inside the vehicle to below the outside temperature. Auxiliary heating helps to heat up the vehicle while the engine is running and at low outside temperatures.

Operating the hot-water auxiliary heater draws power from the vehicle battery. Therefore, drive a reasonably long distance after heating or ventilating the vehicle twice in succession at most.

### Switching the hot-water auxiliary heater on and off with the button

#### Requirements:

- The fuel tank has been filled above the reserve fuel level.

#### Switching auxiliary heating on/off

▶ **To switch on:** press the  button.

▶ **To switch off:** press the  button.

#### Switching on the target temperature

▶ Switch on the ignition.

▶ **To switch on:** press the  button.

▶ **To switch off:** press the  button.

▶ Set the temperature using the  button.

▶ Press the  button.

The red or blue indicator lamp on the  button goes on or off.



Colours of the indicator lamp:

- **Blue:** auxiliary ventilation has been switched on.
- **Red:** auxiliary heating has been switched on.

- **Yellow:** departure time has been pre-selected.

Auxiliary heating or ventilation switches off after a maximum of 50 minutes.

### Switching heater booster mode on/off

- ▶ **To switch on:** start the engine.
- ▶ Press the  button.
- ▶ **To switch off:** press the  button. Heater booster mode is switched on at an outside temperature of less than 0 °C when necessary.

- ⓘ Heater booster mode is available only for vehicles with hot-water auxiliary heaters.

### Adjusting the hot water auxiliary heater by remote control

#### Requirements:







- The fuel tank has been filled above the reserve fuel level.





#### Switching on immediately









- ▶ Press and hold the  button until the **ON** message appears on the remote control's display.

#### Setting the departure time

- ▶ Briefly press the  button.
- ▶ Continue to press the  or  button until the time to be changed appears on the display.
- ▶ Press the  and  buttons simultaneously. The  symbol on the remote control display will flash.

- ▶ Set the required departure time with the  and  buttons.
- ▶ Press the  and  buttons simultaneously. The new departure time will be saved.

Up to three departure times can be saved.

- ▶ **To activate the departure time:** briefly press the  button.
- ▶ Select the required departure time with the  and  buttons.
- ▶ Press and hold the  button. The  symbol, the departure time and, depending on the selected departure time, letter **A**, **B** or **C** will appear on the remote control's display.
- ▶ **To deactivate the departure time:** select the required departure time and press and hold the  button. **OFF** will appear on the display.
- ▶ **To check the status of the active stationary heater:** briefly press the  button.

#### Switching off immediately

- ▶ Press and hold the  button.

#### Overview of remote control displays (stationary heating/ventilation)

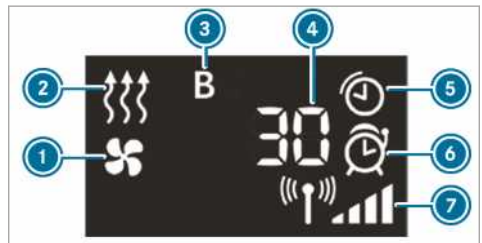

- ① Stationary ventilation switched on
- ② Stationary heating switched on
- ③ Selected departure time
- ④ Remaining stationary heating or ventilation time (in minutes)
- ⑤ Stationary heating or ventilation active
- ⑥ Departure time activated
- ⑦ Signal strength

Further display options:

- **Time:** The selected departure time.

- **0 minutes:** The runtime of the stationary heating extends as the engine has not yet reached the operating temperature.
- **OFF:** Stationary heating or ventilation has been switched off.

**Changing the remote control's battery (stationary heating)**

**⚠ DANGER** Serious damage to health caused by swallowing batteries

Batteries contain toxic and corrosive substances. Swallowing batteries may cause serious damage to health.

There is a risk of fatal injury.

- ▶ Keep batteries out of the reach of children.
- ▶ If batteries are swallowed, seek medical attention immediately.

**🔥 ENVIRONMENTAL NOTE** Environmental damage due to improper disposal of batteries



Batteries contain toxic and corrosive substances.



Take discharged batteries to a qualified specialist workshop or to a collection point for used batteries.

**Requirements:**

- A CR2450 lithium battery is available.



- ▶ Push a pointed object into the recess ①.
- ▶ Slide battery cover ② backwards in the direction of the arrow.
- ▶ Insert the new battery ③ with the lettering facing upwards.
- ▶ Slide the battery cover ② onto the remote control in the opposite direction to the arrow until the battery cover engages.

**Adjusting the hot-water auxiliary heater with the on-board computer**

**Requirements:**

- The fuel tank has been filled above the reserve fuel level.
- The ignition is switched on.

On-board computer:

➤ [Styles & display](#) ➤ [Heating](#)

**Setting the switch-on time**

- ▶ Select [Styles & display](#).
- ▶ Set the required departure time.

**Activating the programmed time**

- ▶ Select [Vorwahlzeit](#).  
The tick shows that the function has been switched on.

ⓘ The programmed time remains set only until the next time the engine is started.

**Selecting programmed time**

- ▶ Select [Vorwahlzeit](#).
- ▶ Select required programmed time A, B or C.

**Problems with hot water auxiliary heating**

Problem	Possible causes/consequences and ▶ Solutions
FAIL (📶)	Signal transmission between transmitter and vehicle is malfunctioning.

Problem	Possible causes/consequences and ► Solutions
	► Change your position in relation to the vehicle, moving closer if necessary.
FAIL	The starter battery is not sufficiently charged. ► Charge the starter battery.
	The fuel tank is not filled up to the reserve level. ► Refuel at the nearest filling station.
FAIL 	Stationary heating is malfunctioning. ► Have stationary heating checked in a qualified specialist workshop.

## Auxiliary warm-air heater

### Timer overview

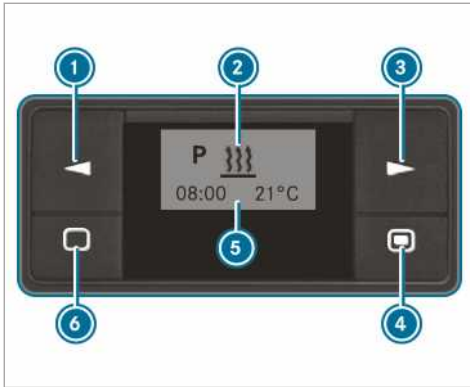

- ① Select option/change values
- ② Menu bar
- ③ Select option
- ④ Press briefly to select or confirm a setting/press and hold to switch immediate heating mode on/off
- ⑤ Status bar
- ⑥ Press briefly to switch on the timer/cancel or terminate the settings in a menu; press and hold to terminate all functions

### Setting the timer



- Press the ⑥ button.
- ⓘ The timer will switch to standby mode after ten seconds. The display will go off.

### Setting the timer

#### Setting the time

You must reset the day, time and default value for the operating duration in the following cases:

- initial operation
- after a voltage supply interruption (e.g. if the battery has been disconnected)
- after a malfunction

- Press button ① or ③ until  flashes on the menu bar ②.
- Press the ④ button.
- Press button ① or ③ until  flashes.
- Press the ④ button.
- Set the hour with button ① or ③.
- Press the ④ button.
- Set the minutes with button ① or ③.
- Press the ④ button.

#### Setting the time format

- Press button ① or ③ until  flashes on the menu bar ②.
- Press the ④ button.
- Press button ① or ③ until the symbol for the time format flashes.
- Press the ④ button.
- Select the desired time format using button ① or ③.
- Press the ④ button.



#### Setting the day

- Press button ① or ③ until  flashes on the menu bar ②.
- Press the ④ button.



- ▶ Press the ❶ or ❸ button until the symbol for the day flashes.
- ▶ Press the ❹ button.
- ▶ Use the ❶ or ❸ button to select the required day of the week.
- ▶ Press the ❹ button.

**Switching immediate heating mode on/off**

- ▶ **To switch on:** press button ❹ until  flashes on menu bar ❷.  
On briefly appears on the display and then the remaining operating duration or the  symbol for continuous operation.
- ▶ **To switch on:** press button ❹ until Off appears on the display.

**Setting the departure time**

You can set three departure times with the switch clock. Following malfunctions or if the battery has been disconnected, you will need to re-set the departure times.

- ▶ **To set the departure time:** press the ❶ or ❸ button until  flashes on the ❷ menu row.
- ▶ Press the ❹ button.  
The numbers of the program memories are shown in the program column ❺. The tick denotes activated program memories.

- ▶ Use the ❶ or ❸ button to select the required program memory.
- ▶ Press the ❹ button.
- ▶ **To activate/deactivate program memories:** use the ❶ or ❸ button to select On or Off.
- ▶ Press button ❹.
- ▶ **To edit the program memory:** use the ❶ or ❸ button to select .
- ▶ Press the ❹ button.
- ▶ Set the day of the week and the time (→ page 107).

**Setting the temperature and operating duration**

- ▶ Press the ❹ button.
  - ▶ Set the temperature with button ❶ or ❸.
  - ▶ Press the ❹ button.
  - ▶ Set the operating duration with button ❶ or ❸ or select the  symbol for continuous operation.
  - ▶ Press the ❹ button.
- ❶ The operating duration set is the default setting for immediate heating mode. You can set the operating duration within a range of 10 to 120 minutes or to continuous operation.

**Problems with the auxiliary warm-air heater**

Problem	Possible causes/consequences and Solutions
The message <b>ERROR</b> appears on the switch clock's display.	A malfunction has occurred. ▶ Have the auxiliary heating checked at a qualified specialist workshop.
The message <b>INIT</b> appears on the switch clock's display.	The power supply has been interrupted. All saved settings have been deleted. Automatic hardware detection is currently active. ▶ When automatic hardware detection is complete, set the day of the week, time and operating duration (→ page 107). ▶ Set the departure time (→ page 108).
Auxiliary heating automatically switches off and/or cannot be switched on.	The low-voltage protection system integrated in the control unit switches auxiliary heating off as the on-board voltage is below 10 V. ▶ Have the generator and the battery checked.
	The electrical fuse has blown. ▶ Replace the electrical fuse; see "Fuse assignment" supplement.

Problem	Possible causes/consequences and ► Solutions
	<ul style="list-style-type: none"> <li>► Have the cause of the faulty fuse investigated at a qualified specialist workshop.</li> </ul>
The auxiliary warm-air heating is overheated.	<p>The air ducts are clogged.</p> <ul style="list-style-type: none"> <li>► Ensure that the flow of hot air is not blocked.</li> <li>► Have the auxiliary heating checked at a qualified specialist workshop.</li> </ul>

### Operating load compartment ventilation

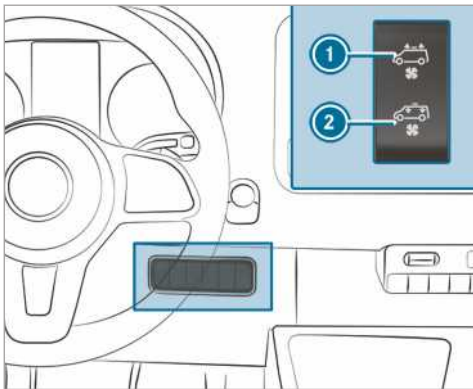

If your vehicle is equipped with a roof ventilator, you can admit fresh air to the load compartment, or extract air from it as well.

- Switch on the ignition.
- **To switch on and extract:** press the switch ① at the top.  
The roof ventilator removes used air from the load compartment.
- **To switch on and admit fresh air:** press the switch ② at the bottom.  
The roof ventilator feeds fresh air into the load compartment.
- **To switch off:** place the switch in the centre position.

## Driving

### Switching on power supply or ignition with the start/stop button

**▲ WARNING** Risk of accident and injury due to children left unattended in the vehicle

If children are left unattended in the vehicle, they could:

- open doors, thereby endangering other persons or road users.
- get out of the vehicle and be hit by oncoming traffic.
- operate vehicle equipment and become trapped, for example.

In addition, children could also set the vehicle in motion, for example, by:

- releasing the parking brake.
- shifting the automatic transmission out of park position **P** or shifting manual transmission into neutral.
- starting the engine.

- ▶ When leaving the vehicle, always take the key with you and lock the vehicle.
- ▶ Never leave children and animals unattended in the vehicle.
- ▶ Keep the vehicle key out of reach of children.

**▲ WARNING** Risk of exhaust gas poisoning

Combustion engines emit poisonous exhaust gases such as carbon monoxide. Inhaling these exhaust gases causes poisoning.

- ▶ Never leave the engine running in an enclosed space without sufficient ventilation.

**▲ WARNING** Risk of fire caused by flammable material on the exhaust system

Flammable materials brought in by either animals or environmental influences may ignite if they come into contact with hot parts of the engine or exhaust system.

- ▶ Therefore, check regularly that there are no flammable materials in the engine compartment or on the exhaust system.

### Requirements:

- the key is in detection range of the aerial (→ page 41) and the key battery is not discharged.

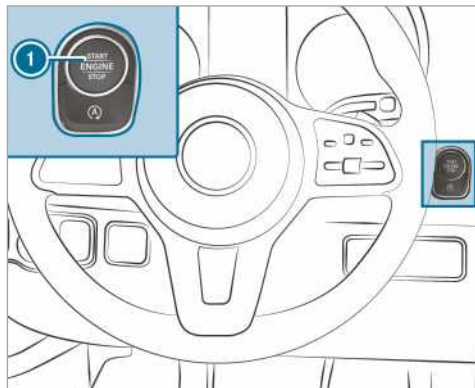

▶ **To switch on the power supply:** press button ① once.  
You can now activate the windscreen wipers, for example.

The power supply is switched off again when the following conditions are met:

- the driver's door is open.
- you press button ① twice.

▶ **To switch on the ignition:** press button ① twice.  
The indicator lamps appear in the instrument cluster.

The ignition is switched off again when one of the following conditions is met:

- you do not start the vehicle within 15 minutes.
- you press button ① once.

## Starting the engine

### Starting the vehicle with the start/stop button

**⚠ WARNING** Risk of accident and injury due to children left unattended in the vehicle

If children are left unattended in the vehicle, they could:

- open doors, thereby endangering other persons or road users.
- get out of the vehicle and be hit by oncoming traffic.
- operate vehicle equipment and become trapped, for example.

In addition, children could also set the vehicle in motion, for example, by:

- releasing the parking brake.
- shifting the automatic transmission out of park position **P** or shifting manual transmission into neutral.
- starting the engine.

- ▶ When leaving the vehicle, always take the key with you and lock the vehicle.
- ▶ Never leave children and animals unattended in the vehicle.
- ▶ Keep the vehicle key out of reach of children.

### Requirements:

- the key is in detection range of the aerial (→ page 41) and the key battery is not discharged.

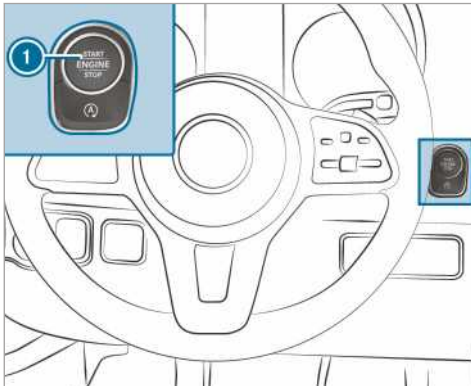

▶ **Vehicles with manual transmission:**  
depress the clutch pedal.

▶ **Vehicles with automatic transmission:**  
shift the transmission to position **P** or **N**.

▶ Depress the brake pedal and press button **1** once.

▶ If the vehicle does not start: switch off unnecessary consumers and press button **1** once.

▶ If the vehicle still does not start and the display message **Place the key in the marked space** See **Owner's Manual** appears in the multifunction display: start the vehicle in emergency operation mode.

### Starting the vehicle in emergency operation mode

**⚠ WARNING** Risk of accident and injury due to children left unattended in the vehicle

If children are left unattended in the vehicle, they could:

- open doors, thereby endangering other persons or road users.
- get out of the vehicle and be hit by oncoming traffic.
- operate vehicle equipment and become trapped, for example.

In addition, children could also set the vehicle in motion, for example, by:

- releasing the parking brake.
- shifting the automatic transmission out of park position **P** or shifting manual transmission into neutral.
- starting the engine.

- ▶ When leaving the vehicle, always take the key with you and lock the vehicle.
- ▶ Never leave children and animals unattended in the vehicle.
- ▶ Keep the vehicle key out of reach of children.

If the vehicle does not start and the display message **Place the key in the marked space** See **Owner's Manual** appears in the multifunction display, you can start the vehicle in emergency operation mode.

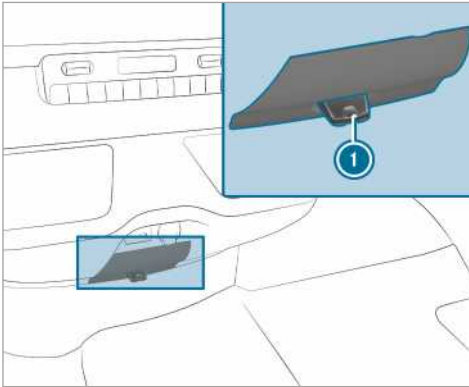

- ▶ Remove the key ① from your key ring.
- ▶ Insert the key ① in the slot. The vehicle is started after a brief time.
- ▶ Leave the key inserted during the entire journey.
- ▶ If you pull the key ① out of the slot, the motor continues to run.
- ▶ Have the key ① checked at a qualified specialist workshop.

**If the vehicle does not start:**

- ▶ leave the key ① in the slot.
  - ▶ **Vehicles with manual transmission:** depress the clutch pedal.
  - ▶ **Vehicles with automatic transmission:** depress the brake pedal.
  - ▶ Start the vehicle with the start/stop button.
- ① You can also switch on the power supply or the ignition with the start/stop button.

**Running-in notes**

Protect the engine during the first 1500 km by:

- driving at varying road and engine speeds.
- shifting to the next gear up when or before the rev counter needle is  $\frac{2}{3}$  of the way to the red area.
- avoiding stress on the vehicle such as driving at full throttle.
- not shifting manually to a lower gear to brake.
- after 1500 km, gradually increasing the engine speed and accelerate the vehicle up to full speed.

- **vehicles with automatic transmission:** not depressing the accelerator pedal beyond the pressure point (kickdown).

This also applies if the engine or parts of the drivetrain have been renewed.

Also observe the following running-in notes:

- The sensors of the ESP® driving safety system adjust automatically while a certain distance is being driven after the vehicle has been delivered or after repairs. Full system effectiveness is not reached until the end of this teach-in process.
- New or exchanged brakepads, brake discs and tyres only provide optimal braking and bonding after several hundred kilometres. Until then, compensate for the reduced braking effect by applying greater pressure to the brake pedal.

**Driving tips**

**Notes on driving**

**▲ WARNING** Risk of accident due to objects in the driver's footwell

Objects in the driver's footwell may impede pedal travel or block a depressed pedal.

This jeopardises the operating and road safety of the vehicle.

- ▶ Stow all objects in the vehicle securely so that they cannot get into the driver's footwell.
- ▶ Ensure floor mats and carpets cannot slip and provide sufficient room for the pedals.
- ▶ Do not lay multiple floor mats or carpets on top of one another.

**▲ WARNING** Risk of accident due to unsuitable footwear

Operating the pedals may be impaired by wearing unsuitable footwear, e.g.:

- platform shoes
  - high-heeled shoes
  - slippers
- ▶ Always wear suitable footwear when driving so that you can operate the pedals safely.

**⚠ WARNING** Risk of accident when the ignition is switched off due to steering wheel lock

If you switch off the ignition while the vehicle is at a standstill, the steering wheel lock engages in vehicles with manual transmission.

You can no longer steer the vehicle.

- ▶ Turn on the ignition before rolling the vehicle to deactivate the steering wheel lock.

**⚠ WARNING** Risk of accident when switching off the ignition when driving

If you switch off the ignition while driving, safety functions are restricted or no longer available. This may affect the power steering system and the brake force boosting, for example.

You will then need to use considerably more force to steer and brake.

- ▶ Do not switch off the ignition while driving.

**⚠ WARNING** Risk of exhaust gas poisoning

Combustion engines emit poisonous exhaust gases such as carbon monoxide. Inhaling these exhaust gases causes poisoning.

- ▶ Never leave the engine running in an enclosed space without sufficient ventilation.

**⚠ WARNING** Risk of skidding and of an accident due to shifting down on slippery road surfaces

If you shift down on slippery road surfaces to increase the engine braking effect, the drive wheels may lose traction.

- ▶ Do not shift down on slippery road surfaces to increase the engine braking effect.

**⚠ DANGER** Risk of fatal injuries due to poisonous exhaust gases

If the tailpipe is blocked or sufficient ventilation is not possible, poisonous exhaust gases such as carbon monoxide may enter the vehicle. This is the case, for example, if the vehicle is stuck in snow.

- ▶ When the engine or the stationary heater are running, keep the tailpipe and the area around the vehicle clear of snow.
- ▶ Open a window on the side of the vehicle facing the wind to ensure an adequate supply of fresh air.

**⚠ WARNING** Risk of accident due to overheated brake system

If you rest your foot on the brake pedal during while driving, the brake system may overheat.

This increases the braking distance and the brake system may even fail.

- ▶ Never use the brake pedal as a footrest.
- ▶ Do not press the brake pedal and accelerator pedal simultaneously while driving.

On long and steep downhill gradients, you should change down to a lower gear in good time. Take particular note of this when driving a laden vehicle. By doing so, you will make use of the engine's braking effect. This relieves the load on the brake system and prevents the brakes from overheating and wearing too quickly.

**!** **NOTE** Causing wear to the brake linings by permanently depressing the brake pedal

- ▶ Do not permanently depress the brake pedal while driving.
- ▶ To use braking effect of the engine, shift to a lower gear in good time.

**!** **NOTE** Damage to the drivetrain and engine when pulling away

- ▶ Do not warm up the engine when stationary. Pull away immediately.
- ▶ Avoid high engine speeds and full throttle until the engine has reached its operating temperature.
- ▶ Do not allow the wheels to spin.

**!** **NOTE** Damage to the catalytic converter due to non-combusted fuel

The engine is not running smoothly and is misfiring.

Non-combusted fuel may get into the catalytic converter.

- ▶ Only depress the accelerator pedal slightly.
- ▶ Have the cause rectified immediately at a qualified specialist workshop.

### Short-distance trips

If the vehicle is predominantly used for short-distance driving, fuel may accumulate in the engine oil and cause engine damage.

### Vehicles with a malfunction display (during short-distance trips)

If one of the following displays appears, drive at an engine speed of at least 2,000 rpm until the indicator lamp or the display message in the display disappears, at the earliest possible opportunity:

- the indicator lamp for the diesel particle filter in the instrument display lights up.  
Observe the notes on regeneration (→ page 121).
- the [Exhaust filter Drive at high engine speeds](#) [See Owner's Manual](#) message appears on the multifunction display.

On vehicles with automatic transmission, shift to a lower gear (→ page 125).

Switch the ECO start/stop function off in vehicles with this function.

The diesel particulate filter's burn-off process is assisted by the intentional temperature increase.

If the indicator lamp or the display message does not go out after approximately 40 minutes, consult a qualified specialist workshop immediately.

### Vehicles without a malfunction display (during short-distance trips)

If you mainly drive short distances, you should drive on a motorway or go for a country drive for 20 minutes every 500 km. This facilitates the regeneration of the diesel particulate filter.

### Limiting speed

**▲ WARNING** Risk of injury through exceeding the specified tyre load-bearing capacity or the permissible speed rating

Exceeding the specified tyre load-bearing capacity or the permissible speed rating may lead to tyre damage and to the tyres bursting.

- ▶ Therefore, only use tyre types and sizes approved for your vehicle model.
- ▶ Observe the tyre load-bearing capacity rating and speed rating required for your vehicle.

As the driver, you must find out about the maximum permissible speed for the tyres (tyre and tyre pressure). In particular, you must observe the legal requirements for tyres for the country you are in.

You can permanently limit the speed of your vehicle.

Mercedes-Benz recommends a qualified specialist workshop for programming the speed limitation.

On vehicles with a limiter, you can temporarily or permanently limit the speed of your vehicle using the on-board computer (→ page 151).

Before overtaking, take into consideration that the engine speed limiter prevents the speed increasing beyond the programmed speed limitation.

On downhill gradients, the speed limitation may be exceeded. Apply the brakes if necessary.

Display messages indicate that you are approaching the limit speed.

### Driving abroad

#### Service

An extensive Mercedes-Benz service is also available abroad. Nevertheless, please remember that services or spare parts may not be available immediately. The relevant workshop directories are available from a Mercedes-Benz Service Centre.

#### Fuel

In some countries, only fuels with a low octane number or increased sulphur content are available.

Mercedes-Benz recommends installing a fuel filter with a water separator for countries with an increased water content in diesel fuel.

Unsuitable fuel can cause engine damage. Information about fuel (→ page 336).

#### Transport by rail

Transporting your vehicle by rail may be subject to certain restrictions or require special measures to be taken in some countries due to varying tunnel heights and loading standards.

You can obtain information about this from any Mercedes-Benz service centre.

### Notes on brakes

**⚠ WARNING** Risk of skidding and of an accident due to shifting down on slippery road surfaces

If you shift down on slippery road surfaces to increase the engine braking effect, the drive wheels may lose traction.

- ▶ Do not shift down on slippery road surfaces to increase the engine braking effect.

**⚠ WARNING** Risk of accident due to the brake system overheating

If you leave your foot on the brake pedal when driving, the brake system may overheat.

This increases the braking distance and the brake system may even fail.

- ▶ Never use the brake pedal as a footrest.
- ▶ Do not depress the brake pedal and the accelerator pedal at the same time while driving.

### Downhill gradients

On long and steep downhill gradients you should:

- in vehicles with an automatic transmission, shift down to shift ranges **2** or **1** in good time, so that the engine is running at a medium to high engine speed (→ page 125)
- in vehicles with a manual transmission, shift down to a lower gear in good time, so that the engine is running at a medium to high engine speed

**i** You must also change the shift range in good time when cruise control or the speed limiter are switched on.

You thereby make use of the braking effect of the engine and do not have to brake as often to maintain the speed. This relieves the load on the service brake and prevents the brakes from overheating and wearing too quickly.

### Heavy and light loads

**⚠ WARNING** Risk of accident due to the brake system overheating

If you leave your foot on the brake pedal when driving, the brake system may overheat.

This increases the braking distance and the brake system may even fail.

- ▶ Never use the brake pedal as a footrest.
- ▶ Do not depress the brake pedal and the accelerator pedal at the same time while driving.

If the brakes have been subjected to a heavy load, do not stop the vehicle immediately. Drive on for a short while. The brakes cool down more quickly in the airflow.

If the brakes have been used only moderately, you should occasionally test their effectiveness. To do this, brake more firmly from a higher speed while paying attention to the traffic conditions. The brakes will grip better as a result.

### Wet road surfaces

If you have been driving for a long time in heavy rain without braking, there may be a delayed response when you first apply the brakes. This may also occur after driving through a car wash or deep water. You must depress the brake pedal more firmly. Maintain a longer distance to the vehicle in front.

While paying attention to the traffic conditions, you should brake the vehicle firmly after driving on a wet road surface or through a car wash. This heats the brake discs so that they dry more quickly, which protects them against corrosion.

Limited braking effect on salt-treated roads:

- a layer of salt on the brake discs or brake pads/linings can increase braking distances considerably, or braking may happen on only one side.
- maintain an especially great safe distance to the vehicle in front.

To remove the layer of salt:

- apply the brakes from time to time, paying attention to traffic conditions.
- carefully depress the brake pedal at the end of a journey and after the start of a new journey.

### New brake discs and brake pads/linings

New brake pads/linings and brake discs only reach their optimal braking effect after a few 100 km. Until then, compensate for the reduced braking effect by applying greater pressure to the brake pedal. For safety reasons, Mercedes-Benz recommends that you only have brake pads/



linings and brake discs which are approved by Mercedes-Benz installed on your vehicle.

Other brake discs or brake pads/linings may compromise the safety of your vehicle.

Always replace all brake discs and brake pads/linings on an axle at the same time. Always fit new brake pads/linings when replacing brake discs.

### Parking brake

**▲ WARNING** Risk of skidding or an accident by braking with the parking brake

If you have to brake your vehicle with the parking brake, the braking distance is considerably longer and the wheels may lock. There is an increased risk of skidding and/or accident.

- ▶ Only brake the vehicle with the parking brake if the service brake has failed.
- ▶ In this case, do not apply the parking brake with too much force.
- ▶ If the wheels lock, immediately release the parking brake as much as required for the wheels to turn again.

When driving on wet roads or dirt-covered surfaces, road salt and/or dirt may get into the parking brake. This causes corrosion and a reduction of braking force.

In order to prevent this, drive with the parking brake lightly applied from time to time. When doing so, drive for a distance of approximately 100 m at a maximum speed of 20 km/h.

The brake lights do not light up when you brake the vehicle with the parking brake.

### Driving on wet roads

#### Aquaplaning

**▲ WARNING** Risk of aquaplaning because tyre tread is too low

Depending on the depth of the water on the roadway, aquaplaning can occur despite sufficient tyre tread depth and low speed.

- ▶ Avoid tyre ruts and brake carefully.

Therefore, in heavy rain or other conditions in which aquaplaning can occur, drive as follows:

- reduce your speed.
- avoid tyre ruts.

- brake carefully.

### Driving on flooded roads

Bear in mind that vehicles travelling in front or in the opposite direction create waves. This may cause the maximum permissible depth of water to be exceeded. These notes must be observed under all circumstances. Otherwise, you can damage the engine, electrics and transmission.

If you have to drive on stretches of road on which water has collected, please bear in mind the following:

- the water level of standing water may not be above the lower edge of the front bumper.
- you may drive no faster than walking pace.

Observe the notes on fording while off-road for all-wheel drive vehicles (→ page 117).

### Driving in winter

**▲ WARNING** Risk of skidding and of an accident due to shifting down on slippery road surfaces

If you shift down on slippery road surfaces to increase the engine braking effect, the drive wheels may lose traction.

- ▶ Do not shift down on slippery road surfaces to increase the engine braking effect.

**▲ DANGER** Risk of fatal injuries due to poisonous exhaust gases

If the tailpipe is blocked or sufficient ventilation is not possible, poisonous exhaust gases such as carbon monoxide may enter the vehicle. This is the case, for example, if the vehicle is stuck in snow.

- ▶ When the engine or the stationary heater are running, keep the tailpipe and the area around the vehicle clear of snow.
- ▶ Open a window on the side of the vehicle facing the wind to ensure an adequate supply of fresh air.

**▲ WARNING** Risk of skidding and of an accident due to shifting down on slippery road surfaces

If you shift down on slippery road surfaces to increase the engine braking effect, the drive wheels may lose traction.

- ▶ Do not shift down on slippery road surfaces to increase the engine braking effect.

Vehicles with automatic transmissions may roll in neutral position **[N]** for only a short time. Allowing the wheels to roll for longer, e.g. during towing, causes transmission damage.

If the vehicle threatens to skid or cannot be stopped when moving at low speed:

- shift the automatic transmission to neutral position **[N]**.
- shift the manual transmission into neutral or depress the clutch pedal.
- try to maintain control of the vehicle using corrective steering.

Drive particularly carefully on slippery roads. Avoid sudden acceleration, steering and braking manoeuvres.

Have your vehicle winterproofed at a qualified specialist workshop in good time at the onset of winter.

Observe the instructions in the chapter "Notes on snow chains" (→ page 302).

Regularly check the vehicle and remove snow or ice when travelling in wintry conditions. An accumulation of snow and ice, particularly when frozen, caught in the area around the air intake slots, moving parts, the axles and the wheel housing may:

- restrict air intake
- damage car parts
- cause malfunctions by restricting the mobility intended by the design (e.g. reduced possible steering movement)

If there is any damage, inform a qualified specialist workshop.

### Driving off-road

- ▲ WARNING** Risk of accident if you do not keep to line of fall on inclines

If you drive at an angle or turn on an incline, the vehicle could slip sideways, tip and roll-over.

- ▶ Always drive on inclines in the line of fall (straight up or down) and do not turn.

- ▲ WARNING** Risk of injury due to accelerating force during off-road driving

When driving off-road on uneven surfaces, the force of the vehicle's acceleration affects your body from all directions.

You could, for example, be thrown from your seat.

- ▶ Always wear a seat belt when driving off-road.

- ▲ WARNING** Risk of injury to the hands when driving over obstacles

If you drive over obstacles or in tyre ruts, the steering wheel may whip around and cause injuries to the hands.

- ▶ Steering wheel must always be held securely with both hands.
- ▶ When driving over obstacles, expect increased steering forces at short notice.

- ▲ WARNING** Risk of fire due to flammable materials on hot parts of the exhaust system

Flammable material such as leaves, grass or twigs may ignite if they come into contact with hot parts of the exhaust system.

- ▶ When driving on unpaved roads or off-road, regularly check the vehicle underside.
- ▶ Remove trapped plants or other flammable material, in particular.
- ▶ If there is damage, consult a qualified specialist workshop immediately.

When driving off-road or on unpaved surfaces, check the vehicle underside, wheels and tyres regularly at regular intervals. Remove any trapped foreign bodies, e.g. stones and branches.

Observe the following notes for foreign bodies of this kind:

- They may damage the suspension, the fuel tank or the brake system.
- They may disturb the balance and cause vibrations.
- They may be flung out from the vehicle when you continue driving.

If there is any damage, inform a qualified specialist workshop.

If you are driving on steep inclines during off-road driving, you must ensure sufficient capacity in the AdBlue® tank. Therefore, ensure a minimum capacity of ten litres before off-road driving.

During off-road driving and driving on construction sites, sand, mud and water, also mixed with oil, can get into the brakes. This may lead to a reduction in braking effect or total brake failure, also as a result of increased wear. The braking characteristics will vary depending on the material that has got into the system. Clean the brakes after driving off-road. If you then notice reduced braking effect or hear scraping noises, have the brake system checked at a qualified specialist workshop. Adjust your driving style to the changed braking characteristics.

Driving off-road or on construction sites increases the possibility of vehicle damage which may in turn lead to the failure of certain major assemblies and systems. Adapt your driving style to the off-road driving conditions. Drive carefully. Have any vehicle damage rectified at a qualified specialist workshop as soon as possible.

When driving on rough cross-country terrain, do not shift the transmission into the neutral position and do not disengage the clutch. You could lose control when attempting to brake the vehicle with the service brake. If your vehicle cannot manage an uphill incline, drive back down in reverse gear.

When loading your vehicle for off-road driving or on a construction site, keep the vehicle's centre of gravity as low as possible.

### Checklist before off-road driving

- Check the fuel and AdBlue® levels (→ page 174) and top up if necessary (→ page 133).
- **Engine:** check the oil level and top up with oil if necessary (→ page 273). Before driving up or down extreme inclines or slopes, fill the oil to the maximum level.
- ① If you drive up or down extreme inclines or slopes, the on-board computer may display the symbol. The engine operating safety is not put at risk if you have filled the engine oil to the maximum level before the journey.
- **Vehicle tool kit:** check that the jack is working (→ page 320).
- Make sure that a wheel wrench (→ page 320), wooden underlay for the jack,

a robust tow rope, a folding spade and a wheel chock are carried in the vehicle.

- **Tyres and wheels:** check the tyre tread depth (→ page 301) and tyre pressure (→ page 315).

### Rules for off-road driving

Always be aware of the ground clearance of the vehicle and avoid obstacles such as deep tyre ruts.

Obstacles can damage the following parts of the vehicle, for example:

- suspension
- drivetrain
- fuel and supply tanks

Therefore, always drive slowly when off-road. If you must drive over obstacles, have the co-driver instruct you.

- ① Mercedes-Benz recommends that you additionally carry a shovel and a recovery rope with a shackle in the vehicle.
- Make sure that loads and items of luggage are securely stored or lashed down (→ page 73).
- Before driving off-road, stop the vehicle and engage a low gear.
- **Vehicles with DSR:** activate DSR when you are driving downhill (→ page 129).
- **All-wheel drive vehicle:** activate all-wheel drive (→ page 128) and, if necessary, activate the LOW RANGE transmission ratio (→ page 128).
- If the surface requires, temporarily deactivate ASR when pulling away (→ page 128).
- Only drive off-road with the engine running and a gear engaged.
- Drive slowly and smoothly. Walking pace is necessary in many situations.
- Avoid spinning the driven wheels.
- Always ensure that the wheels remain in contact with the ground.
- Exercise the utmost caution when driving across unfamiliar, unpredictable terrain. As a precaution, get out of the vehicle to take a look at the route to be taken first.
- Watch out for obstacles (e.g. rocks, holes, tree stumps and tyre ruts).
- Avoid edges where the surface could crumble or break away.

### Rules for fording off-road (all-wheel drive vehicles)

- Observe the safety notes and general notes on driving off-road.
- Check the depth and characteristics of the body of water before fording. The water must not be deeper than 60 cm.
- The climate control system is switched off (→ page 99).
- The auxiliary heating is switched off (→ page 104).
- Switch on all-wheel drive (→ page 127) and engage it on vehicles with the LOW RANGE transmission ratio (→ page 128).
- Restrict the shift range to 1 or 2.
- Avoid high engine speeds.
- Drive slowly and smoothly at no more than a walking pace.
- Ensure that no bow wave forms while driving.
- After fording, dry the brakes.

After driving through a body of water in which the water was deeper than 50 cm, make sure to check all vehicle fluids for any signs of penetration by water.

### Checklist after driving off-road

If you find damage to the vehicle after off-road driving, have the vehicle checked at a qualified specialist workshop immediately.

Driving over rough terrain places greater demands on your vehicle than normal road operation. Check your vehicle after driving on rough terrain. This allows you to detect damage promptly and reduce the risk of an accident to yourself and other road users. Clean your vehicle thoroughly before driving on public roads.

Observe the following points after driving off-road, on construction sites and before driving on public roads:

- **Vehicles with DSR:** deactivate DSR (→ page 129).
- **All-wheel drive vehicles:** deactivate all-wheel drive (→ page 128).
- Activate ASR (→ page 128).
- Clean the exterior lighting, particularly the headlamps and tail lamps, and check them for damage.
- Clean the front and rear licence plates.

- Clean the windscreen, windows and outside mirrors.
- Clean the steps, entrances and grab handles. This increases the safety of your footing.
- Clean the wheels and tyres, wheel wells and the underbody of the vehicle with a water jet. This increases road adhesion, especially on wet roadways.
- Check the wheels and tyres and wheel wells for trapped foreign objects and remove them. Trapped foreign objects can damage the wheels and tyres or may be flung out from the vehicle when continuing the journey.
- Check the underbody for trapped branches or other parts of plants and remove them.
- Clean the brake discs, brakepads and axle joints, particularly after operation in sand, mud, grit and gravel, water or similarly dirty conditions.
- Check the entire floor assembly, the tyres, wheels, bodywork structure, brakes, steering, suspension and exhaust system for any damage.
- Check the service brake for operating safety, e.g. carry out a brake test.
- If you notice strong vibrations after driving off-road, check the wheels and drivetrain for foreign objects again. Remove any foreign objects which can lead to imbalances and thus cause vibrations. In the event of damage to the wheels and the drive train, visit a qualified specialist workshop immediately.

### Driving in mountainous areas

Vehicles with diesel engines: the operating safety of the diesel engine is guaranteed up to an altitude of 2,500 m above sea level. You may exceed this height for a short time, e.g. in mountainous terrain. Do not drive at altitudes above 2,500 m as you may damage the diesel engine.



When driving in mountainous areas, note that the engine power, and therefore its gradient-climbing capability, decrease with increasing altitude. The ECO Start function is not available when driving at altitudes of 2,500 m above sea level. Notes on braking on downhill gradients can be found in Notes on braking (→ page 115).

## ECO start/stop function

### ECO start/stop function operation

The engine is switched off automatically if the following conditions are met:

- **Vehicles with manual transmission:** you decelerate the vehicle to a lower speed, then engage neutral **[N]** and then release the clutch pedal.
- **Vehicles with automatic transmission:** you keep the vehicle in transmission position **[D]** or **[N]**.
- All on vehicle conditions for automatic engine stop are met.

When stationary, the  symbol appears in the multifunction display. If all on vehicle conditions are not met, the  symbol appears in the multifunction display.

The engine restarts automatically in the following cases:

- **Vehicles with manual transmission:** you depress the clutch pedal.
- **Vehicles with manual transmission:** you engage reverse gear **[R]**.
- **Vehicles with automatic transmission:** you release the brake pedal in transmission position **[D]** and with the HOLD function deactivated.
- **Vehicles with automatic transmission:** you shift out of transmission position **[P]**.
- **Vehicles with automatic transmission:** you select transmission position **[D]** or **[R]**.
- you depress the accelerator pedal.
- an on vehicle automatic engine start is required.

If the engine was switched off by the ECO start/stop function and you leave the vehicle, a warning tone sounds. Additionally, the **Vehicle is operational Switch off the ignition before exiting** display message appears in the multifunction display. If you do not switch off the ignition, the ignition is automatically deactivated after one minute.

### Switching the ECO start/stop function off/on

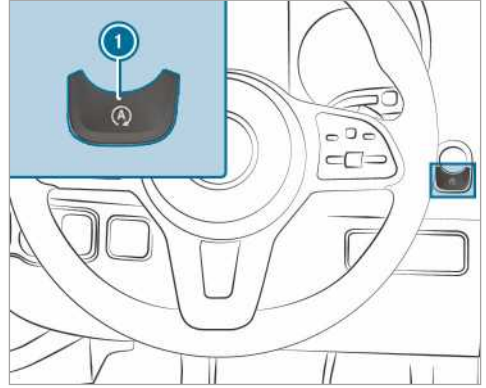

- ▶ Press button . A display appears in the instrument cluster when the ECO start/stop function is switched off or on.

- ⓘ A display appears in the instrument cluster constantly while the ECO start/stop function is switched off.

### ECO display function



The ECO display summarises the driving characteristics from the start of the journey to its completion and assists you in achieving the most economical driving style.

You can influence consumption:

- Drive in an anticipatory manner.
- Comply with the gear shift recommendations.



The segment's lettering lights up bright, the outer edge lights up and the segment is filled, in the following cases:

-  uniform speed
-  smooth deceleration and rolling
-  moderate acceleration

The segment's lettering is grey, the outer edge is dark and the segment is emptied, in the following cases:

- ① speed fluctuations
- ② heavy braking
- ③ sporty acceleration

You have driven in a consumption-optimised manner:

- The three segments have been completely filled simultaneously.
- The edge of all three segments lights up.

The additional range that you have achieved with your driving style compared to a driver with a very sporty driving style is shown in the middle of the display ④. This range does not correspond to any fixed consumption saving.

## Diesel particulate filter

### Notes on regeneration

#### **⚠ WARNING** Risk of exhaust gas poisoning

Combustion engines emit poisonous exhaust gases such as carbon monoxide. Inhaling these exhaust gases causes poisoning.

- ▶ Never leave the engine running in an enclosed space without sufficient ventilation.

#### **⚠ WARNING** Risk of fire caused by hot exhaust system parts

Flammable material such as leaves, grass or twigs may ignite if they come into contact with hot parts of the exhaust system or exhaust gas flow.

- ▶ Park the vehicle so that no flammable material can come into contact with hot vehicle components.
- ▶ In particular, do not park on dry grassland or harvested grain fields.

If the vehicle is predominantly used for short-distance driving or power take-off is used when stationary, it could lead to malfunctions in the automatic cleaning function of the diesel particulate filter. The diesel particulate filter may become overloaded causing loss of engine power.

- ① If your vehicle has a particulate filter load display or a regeneration display, you can dis-

play this in the multifunction display. If necessary, you can request regeneration of the diesel particulate filter via the regeneration display. (→ page 121)

- ① Regular regeneration of the diesel particulate filter can prevent malfunctions, thinning of the engine oil and loss of engine power.

#### **!** NOTE Damage due to hot exhaust gases

During regeneration, extremely hot exhaust gases escape from the tailpipe.

- ▶ During regeneration, maintain a minimum distance of 2 m from other objects, e.g. parked vehicles.

### Starting and cancelling regeneration

#### Requirements:

- all system conditions are fulfilled.
- the load condition of the diesel particulate filter is over 50%.
- the vehicle can be driven.

- ① If your vehicle has a particulate filter load display or a regeneration display, you can display this in the multifunction display. If necessary, you can request regeneration of the diesel particulate filter via the regeneration display. (→ page 121)

On-board computer:

↪ [Service](#) ▶ [Particle filter](#)

#### **!** NOTE Damage due to hot exhaust gases

During regeneration, extremely hot exhaust gases escape from the tailpipe.

- ▶ During regeneration, maintain a minimum distance of 2 m from other objects, e.g. parked vehicles.

If the vehicle is used under normal operating conditions, it is not necessary to additionally request regeneration.

▶ **To request regeneration:** select **OK**.

The **Manual regeneration requested** message appears.

Depending on the driving mode and environmental conditions, it may take 20 minutes until the regeneration starts.

When the regeneration starts, the message **Regeneration active** appears. Regeneration takes approx. 15 minutes.

- ▶ If possible, drive at an engine speed of at least 2000 rpm during regeneration. The diesel particulate filter's burn-off process is assisted by the intentional temperature increase.
- ▶ **To cancel regeneration:** switch off the engine. Regeneration is cancelled. If regeneration is not completed, you can restart regeneration after starting the engine again. Depending on the load condition of the diesel particulate filter, regeneration starts automatically when you drive the vehicle again.

### Battery main switch

#### Notes on the battery main switch

#### **!** NOTE Damage to the electrical system

If you remove or disconnect the battery main switch, it could lead to the electrical system becoming damaged.

- ▶ Make sure that the ignition is switched off and that at least 15 minutes have passed before removing or reconnecting the battery main switch. Otherwise, electrical system components could be damaged.

You can use the battery main switch to disconnect the current to all your vehicle's consumers. This will prevent uncontrolled battery discharge caused by quiescent current consumers.

If your vehicle is equipped with an auxiliary battery in the engine compartment or in the base of the co-driver's seat, you must disconnect both batteries. Only then is the electrical system fully disconnected from the power supply.

- i** Only disconnect from the power supply using the battery main switch if:
  - the vehicle is stationary for a long period of time
  - it is absolutely necessary

After switching on the power supply, you will need to reset the side windows (→ page 55) and the electric sliding door (→ page 50).

- i** A break in the power supply is entered in the DTCO (digital tachograph) as an event in the fault memory. See the separate DTCO operating instructions.

### Switching the power supply on/off

#### Switching off the power supply

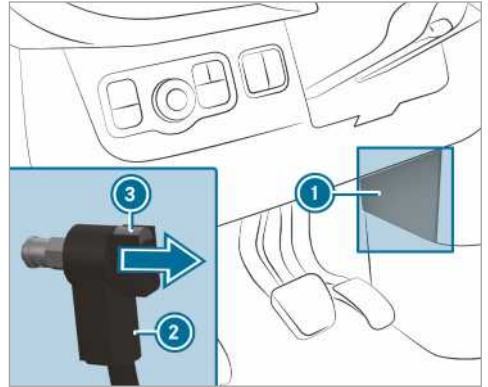

- ▶ Switch off the ignition and wait at least 15 minutes.
- ▶ Remove cover **1**.
- ▶ Press and hold button **3**.
- ▶ Pull plug **2** out of the earth pin.
- ▶ Push plug **2** as far as possible in the direction of the arrow so that it cannot make contact with the earth pin. All starter battery consumers are disconnected from the power supply.

#### Switching on the power supply

- ▶ Press plug **2** onto the earth pin until you feel it engage and plug **2** is in full contact with the earth pin. All starter battery consumers are reconnected to the power supply.
- ▶ Fasten cover **1**.

### Manual transmission

#### Using the gearshift lever

- !** NOTE Damage to the engine and transmission by shifting to a gear that is too low

- ▶ When changing between gears **5** and **6** push the gearshift lever to the right.
- ▶ Do not shift down at high speeds.



**!** **NOTE** Damage to the transmission by shifting to reverse gear **R** while the vehicle is in motion

▶ Only shift into reverse gear **R** when the vehicle is stationary.

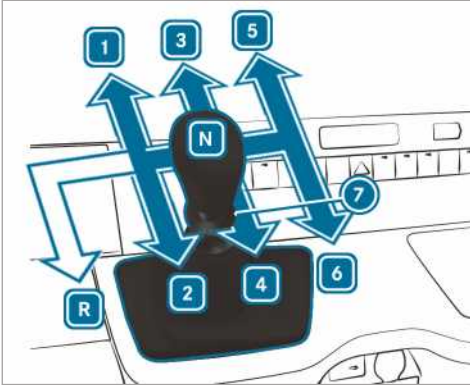

Vehicles with rear wheel drive

- R** Reverse gear
- 1** - **6** Forward gears
- 7** Reverse gear pull ring
- N** Neutral

▶ Depress the clutch pedal and move the gear-shift lever to the desired position.

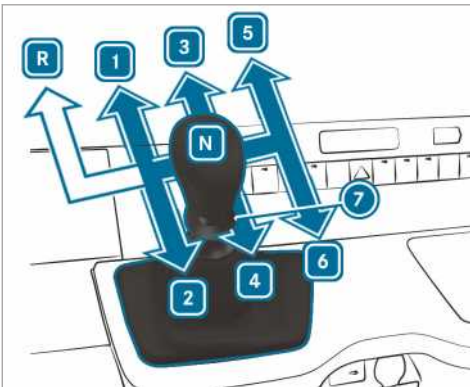

Vehicles with front wheel drive

- R** Reverse gear
- 1** - **6** Forward gears
- 7** Reverse gear pull ring
- N** Neutral

▶ Depress the clutch pedal and move the gear-shift lever to the desired position.

### Gearshift recommendation

The gearshift recommendation provides instructions for a fuel-saving driving style.

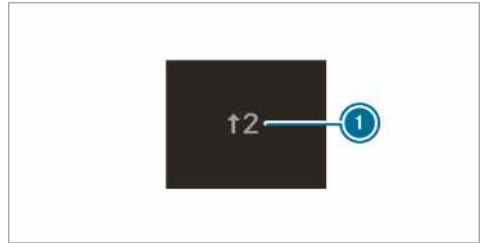

Example image

▶ If the gearshift recommendation **1** appears on the multifunction display, shift to the recommended gear.

**i** In vehicles with an ECO start/stop function, a gearshift recommendation to switch to neutral **N** is displayed as well.

### Automatic transmission

#### DIRECT SELECT lever

#### Function of the DIRECT SELECT lever

**!** **WARNING** Risk of accident and injury due to children left unattended in the vehicle

If children are left unattended in the vehicle, they could:

- open doors, thereby endangering other persons or road users.
- get out of the vehicle and be hit by oncoming traffic.
- operate vehicle equipment and become trapped, for example.

In addition, children could also set the vehicle in motion, for example, by:

- releasing the parking brake.
- shifting the automatic transmission out of park position **P**.
- starting the engine.



- ▶ Never leave children and animals unattended in the vehicle.
- ▶ When leaving the vehicle, always take the key with you and lock the vehicle.
- ▶ Keep the key out of the reach of children.

**⚠ WARNING** Risk of accident due to incorrect gearshifting

If the engine speed is higher than the idle speed and you engage the transmission position **D** or **R**, the vehicle may accelerate sharply.

- ▶ If you engage the transmission position **D** or **R** always depress the brake pedal firmly and do not accelerate at the same time.

You use the DIRECT SELECT lever to switch the transmission position. The current transmission position is shown in the multifunction display.

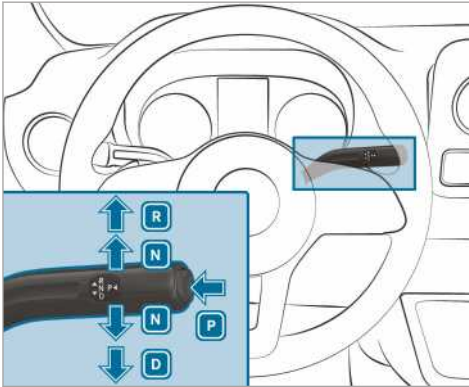

- P** Park position
- R** Reverse gear
- N** Neutral
- D** Drive position

**Engaging reverse gear R**

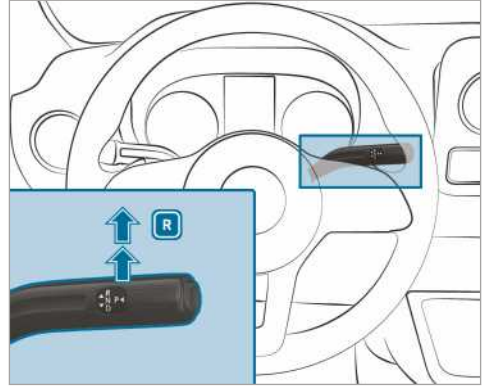

- ▶ Depress the brake pedal and push the DIRECT SELECT lever upwards past the first point of resistance. Transmission position display **R** is shown in the multifunction display.

**Selecting neutral N**

**⚠ WARNING** Risk of accident and injury when neutral position is engaged

If you park the vehicle with the transmission in neutral position **N** and the parking brake is not engaged, the vehicle may roll away.

There is a risk of accident and injury!

- ▶ Before parking the vehicle, apply the parking brake.

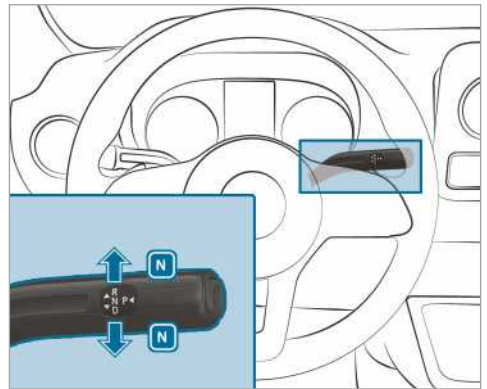

- ▶ Press the brake pedal and the DIRECT SELECT lever upwards or downwards to the first point of resistance. Transmission position display **N** is shown in the multifunction display.

Releasing the brake pedal will allow you to move the vehicle freely, e.g. to push it or tow it.

**If the automatic transmission should also stay in neutral **N** when the ignition is switched off:**

- ▶ start the vehicle.
  - ▶ depress the brake pedal and shift to neutral **N**.
  - ▶ release the brake pedal.
  - ▶ switch off the ignition.
- i** if you then leave the vehicle and the key is still in the vehicle, the automatic transmission will stay in neutral **N** from then on.

### Engaging park position P

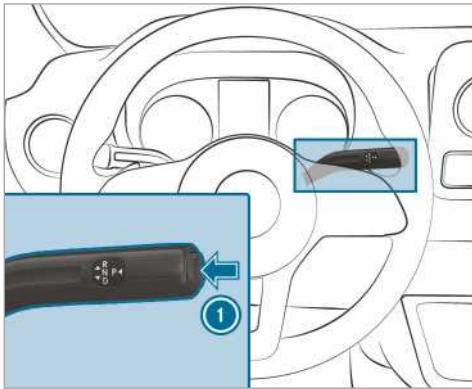

- ▶ Press button **1**. Transmission position display **P** is shown in the multifunction display.

Park position **P** is engaged automatically when one of the following conditions is met:

- you switch off the engine in transmission position **D** or **R**.
- you open the driver's door when the vehicle is stationary or when driving at a very low speed and in transmission position **D** or **R**.
- you open the seat belt buckle when the vehicle is stationary or when driving at a very low speed.

- you leave your seat when the vehicle is stationary or when driving at a very low speed.

### Engaging drive position D

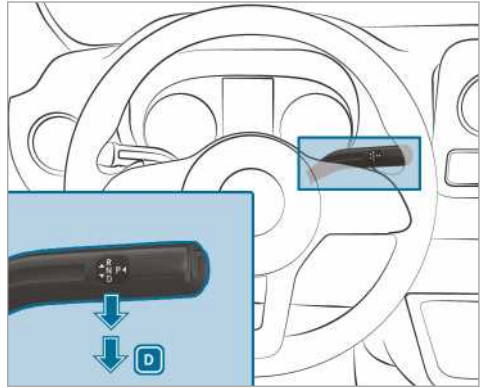

- ▶ Depress the brake pedal and push the DIRECT SELECT lever downwards past the first point of resistance. Transmission position display **D** is shown in the multifunction display.

The automatic transmission shifts through the individual gears automatically when it is in transmission position **D**. This is determined by the following factors:

- the position of the accelerator pedal
- the road speed

### Restricting the shift range

#### Requirements:

- transmission position **D** is engaged (→ page 125).

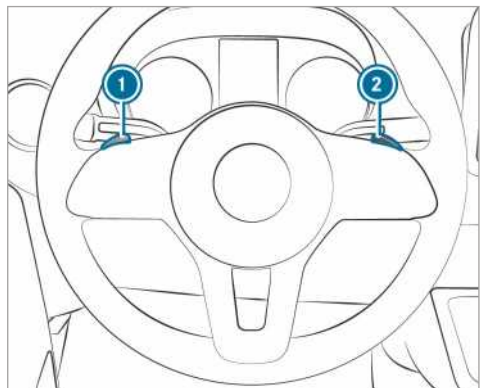

- ▶ **To restrict the shift range:** briefly pull the steering wheel gearshift paddle ①. The automatic transmission shifts to the next gear down, depending on the gear currently engaged. The shift range is also restricted.

The shift range selected is shown in the multifunction display. The automatic transmission shifts only as far as the selected gear.

- ▶ Pull and hold the steering wheel gearshift paddle ①. The automatic transmission will change to a shift range which allows easy acceleration and deceleration. To do this, the automatic transmission shifts down one or more gears and restricts the shift range.

The shift range selected is shown in the multifunction display. The automatic transmission shifts only as far as the selected gear.

- ① The automatic transmission does not shift down if you pull the steering wheel gearshift paddle ① whilst travelling at too high a speed.

If the shift range is restricted and the maximum engine speed for the restricted shift range is reached, the automatic transmission will not shift up.

- ▶ **To derestrict the shift range:** briefly pull the steering wheel gearshift paddle ②. The automatic transmission shifts to the next gear up, depending on the gear currently engaged. This derestricts the shift range at the same time.

The shift range selected is shown in the multifunction display. The automatic transmission shifts only as far as the selected gear.

- ▶ **To derestrict the shift range:** pull and hold the steering wheel gearshift paddle ②. The automatic transmission shifts up one or more gears depending on the gear currently engaged. Simultaneously, the shift range restriction is deactivated and the transmission position appears in the multifunction display **D**.

- ▶ **To derestrict the shift range:** pull and hold the steering wheel gearshift paddle ②.

or

- ▶ Engage transmission position **D** again (→ page 125). The automatic transmission shifts up one or more gears depending on the gear currently engaged. Simultaneously, the shift range restriction is deactivated and the transmis-

sion position appears in the multifunction display **D**.

Shift range driving conditions

- ③ Use the engine's braking effect.
- ② Use the engine's braking effect on downhill gradients and when driving on steep roads, in mountainous areas as well as under arduous operating conditions.
- ① Use the engine's braking effect on extremely steep downhill gradients and on long downhill stretches.

### Using kickdown

- ▶ **For maximum acceleration:** depress the accelerator pedal beyond the pressure point.
- ▶ Ease off the accelerator pedal once the desired speed is reached.

### Deactivating the park pawl manually (vehicles with front wheel drive)

- ① **Vehicles with automatic transmission and front wheel drive:** in the event of damage to the electrics, the automatic transmission may be locked in position **P**. In this case the park pawl can be deactivated mechanically, e.g. to tow away the vehicle (→ page 293).

- ① Mechanical park pawl deactivation is only possible on automatic vehicles with front wheel drive.

Requirements:

- you require the release tool from the vehicle tool kit (→ page 299).

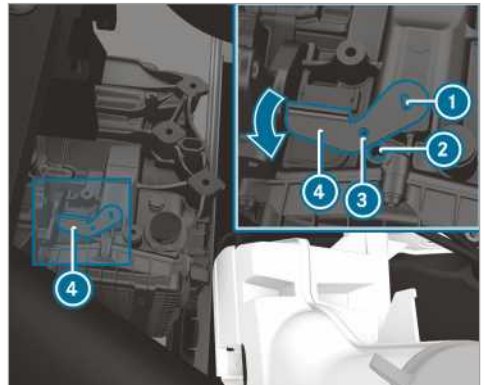

- ▶ Apply the parking brake.
  - ▶ Open the bonnet (→ page 270).
  - ▶ Attach the release tool ④ to the transmission ① and turn in the direction of the arrow.
  - ▶ Insert a suitable tool, e.g. a screwdriver, through the hole on the release tool ③ and into the transmission ②.  
The release tool ④ is securely in position.  
The park pawl is deactivated.  
Position **P** cannot be engaged while release tool ④ is attached to the transmission.
  - ▶ Observe the notes on towing away (→ page 293).
- ⓘ When release tool ④ is removed, the transmission automatically springs back to position **P**.

## All-wheel drive

### Notes on all-wheel drive

All-wheel drive ensures permanent drive for all four wheels, and together with ESP® it improves the traction of the vehicle.

The traction control of the all-wheel drive also takes place via the brake system. Therefore, the brake system can overheat during extreme off-road use. In this case, ease off the accelerator pedal or stop to allow the brake system to cool down.

If a driven wheel spins due to insufficient traction:

- when pulling away, make use of the traction control integrated in ESP®. Depress the accelerator pedal as far as necessary.
- take your foot off the accelerator pedal, slowly, while the vehicle is in motion.

In wintry driving conditions, always use winter tyres (M+S tyres) and, if necessary, snow chains (→ page 302). Only in this way can the maximum effect of all-wheel drive be achieved.

Use DSR (Downhill Speed Regulation) when driving downhill off-road (→ page 128).

If you fail to adapt your driving style or if you are inattentive, the all-wheel drive system can neither reduce the risk of an accident nor override the laws of physics. The all-wheel drive system cannot take road, weather and traffic conditions into account. The all-wheel drive system is only an aid. You are responsible for maintaining a safe distance from the vehicle in front, for vehicle

speed, for braking in good time and for staying in lane.

#### 1 NOTE Risk of damage to the drivetrain and the brake system

If you operate vehicles with all-wheel drive on a one-axle test stand, you may damage the drivetrain or the brake system.

- ▶ A function or performance test should only be carried out on a two-axle test stand.
- ▶ If you wish to operate the vehicle on such a test stand, please consult a qualified specialist workshop in advance.

#### 1 NOTE Risk of damage to the transfer case

If you tow the vehicle with a raised axle, the transfer case can get damaged. Such damage is not covered by Mercedes-Benz implied warranty.

- ▶ Never tow the vehicle with a raised axle.
- ▶ Only tow the vehicle with all wheels on the ground or fully raised.
- ▶ Note the instructions on towing the vehicle with full contact with the ground for all wheels.

## Engaging all-wheel drive

### Conditions for engaging/disengaging

All-wheel drive can be engaged or disengaged in the following situations only:

- if the engine is running
- the vehicle is not travelling faster than 10 km/h
- the vehicle is not being driven around a bend

If it is not possible to engage all-wheel drive when the vehicle is rolling, perform the following:

▶ **vehicles with manual transmission:**  
depress the clutch pedal.



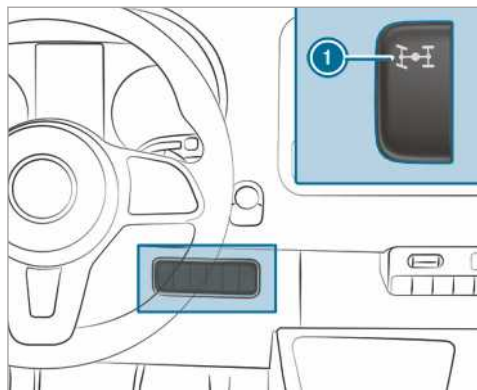

▶ **vehicles with automatic transmission:**  
briefly move the selector lever to **N**.

- ⓘ It is not possible to engage all-wheel drive when the vehicle is stationary. Move the selector lever from **N** to **D** or **R** and back again.

## Engaging/disengaging all-wheel drive



▶ **To engage/disengage:** press the upper section of the switch ①.

The  and  warning lamps light up in the instrument display. ESP® and ASR are deactivated for the duration of the shift operation. If the shift operation is successful, the  and  warning lamps in the instrument display go out and ESP® and ASR are reactivated.

If the LOW RANGE transmission ratio is engaged, all-wheel drive cannot be disengaged.

## LOW RANGE transmission ratio

The LOW RANGE transmission ratio assists you when driving on difficult terrain. If you engage LOW RANGE, the engine's performance characteristics and the automatic transmission's shifting characteristics are adjusted accordingly. The transmission ratio from the engine to the wheels is around 40 % lower than in the road position. The drive torque is increased correspondingly.

### Conditions for engaging/disengaging

LOW RANGE can be engaged or disengaged in the following situations only:

- the engine is running.
- the vehicle is stationary.
- you depress the brake pedal.
- the manual transmission is in neutral.
- the selector lever of the automatic transmission is in position **P** or **N**.
- all-wheel drive is engaged.

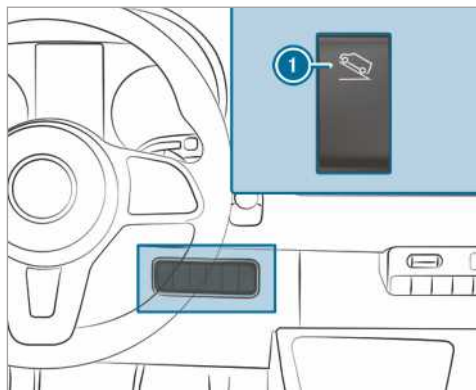

## Engaging/disengaging LOW RANGE





① Engages and disengages LOW RANGE

▶ **To engage/disengage:** press the upper section of the switch ①.

The  indicator lamp flashes in the instrument display for the duration of the shift operation.

- When the shift operation takes place and LOW RANGE is engaged, the  indicator lamp lights up.
- When the shift operation takes place and LOW RANGE is disengaged, the  indicator lamp goes out.

As long as the indicator lamp  is flashing, you can cancel the shift operation by pressing button ① again. If the shift operation fails, the indicator lamp  briefly flashes three times. One of the shift conditions was not met.

## DSR (Downhill Speed Regulation)

### Notes on DSR

If you fail to adapt your driving style or you are inattentive, DSR can neither reduce the risk of accident nor override the laws of physics. DSR cannot take road, weather and traffic conditions into account. DSR is only an aid. You are responsible for a safe distance to the vehicle in front, for vehicle speed and for braking in good time.

DSR assists you in all transmission positions when driving downhill, e.g. when driving off-road or on construction sites. DSR maintains a preset speed for you on downhill gradients by applying the brakes as required. Maintaining the speed is dependent on the road surface conditions and

the downhill gradient and cannot therefore be guaranteed in all situations. Select a set speed suitable for the prevailing conditions and when necessary, apply the brakes manually.

You can set the speed to between 4 km/h and 18 km/h using the brake and accelerator pedals or the rocker switches on the steering wheel.

- If the vehicle is stationary, or its speed is less than 4 km/h, the speed is set to 4 km/h.
- If you drive faster than 18 km/h off-road, DSR switches to standby mode. DSR remains activated, but does not brake automatically.
- If you drive downhill slower than 18 km/h, DSR sets the speed to the previously set speed.
- If you drive faster than 45 km/h, DSR switches off automatically.

## Activating/deactivating DSR

### Activating DSR

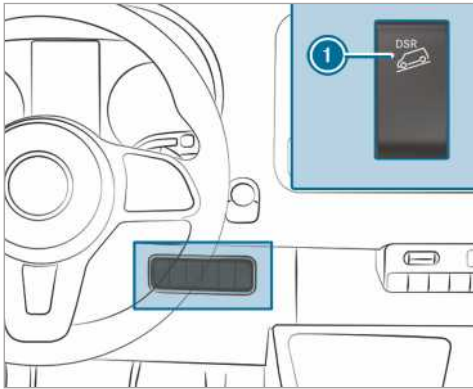

You can activate DSR when the vehicle is stationary or moving.

- ▶ Brake or accelerate the vehicle to the desired speed between 4 km/h and 18 km/h.
- ▶ Press the upper section of switch ①.
- ▶ Release the brake or accelerator pedal. The current speed is stored. When the vehicle is stationary, the speed is stored at 4 km/h. DSR maintains the stored speed on the downhill gradient and brakes automatically.

### Setting the speed

When DSR is activated and the vehicle pulls away, accelerates or brakes, the speed set corresponds to the speed at which the accelerator or

brake pedal is released. This is only the case if you are not driving faster than 18 km/h.

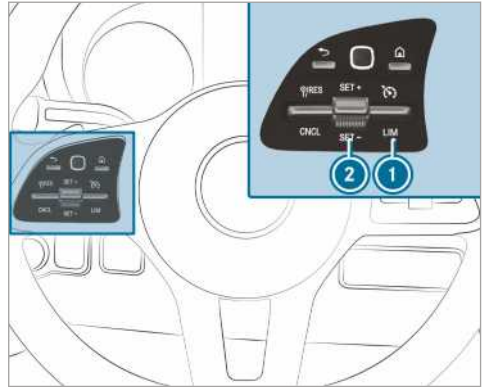

- ▶ Press rocker switch ② up or down and hold. The stored speed is increased or reduced in 1 km/h increments.

### Deactivating DSR

- ▶ Press the upper section of switch ①.
- or
- ▶ Accelerate and drive faster than 45 km/h. DSR deactivates automatically in the following situations:
    - as soon as you exceed a speed of 45 km/h.
    - there is a malfunction in the ESP® or ABS system.

## Electronic level control

### Function of the electronic level control

**⚠ WARNING** Risk of entrapment from vehicle lowering

When lowering the vehicle, other people could become trapped if their limbs are between the vehicle body and the tyres or underneath the vehicle.

- ▶ Make sure no one is underneath the vehicle or in the immediate vicinity of the wheel arches when you lower the vehicle.



**▲ WARNING** Risk of injury from jack tipping

If you park a vehicle with air suspension, the air suspension may remain activated for up to one hour, even when the ignition is switched off. If you then raise the vehicle with the jack, the air suspension will attempt to adjust the vehicle level.

The jack may tip.

- ▶ Press the Service button on the air suspension remote control before raising the vehicle. This prevents automatic readjustment of the vehicle level and prevents it from being raised or lowered manually.

**▲ WARNING** Risk of accident due to lowered or raised chassis

Driving with a lowered or raised chassis may greatly impair braking and handling characteristics. You may also exceed the permissible vehicle height when the chassis is raised.

- ▶ Set the driving level before pulling away.

**▲ WARNING** Risk of accident from malfunction of electronic level control

If electronic level control is malfunctioning, the vehicle level may be asymmetrical, too high or too low.

The driving and steering characteristics of the vehicle may be noticeably different.

- ▶ Adapt your driving style accordingly and drive carefully.
- ▶ Stop, paying attention to road and traffic conditions.
- ▶ Consult a qualified specialist workshop.

**! NOTE** Risk of damage to the chassis from lowered vehicle level

If electronic level control is malfunctioning or readjusts while you are driving, the vehicle level may be lowered.

- ▶ Pay attention to the road conditions and ensure there is sufficient ground clearance.
- ▶ Drive carefully.

The level of the vehicle depends on vehicle load and the load distribution. Electronic level control

adjusts the level of the rear axle automatically on vehicles with an air-sprung rear axle. The vehicle level is thereby always maintained at the driving level, regardless of vehicle load. Driving dynamics remain unaffected. The height difference between the sides of the vehicle may be up to 1 cm .

Electronic level control is not engine dependent and is only operational when the ignition is switched on. The electronic level control compressor works audibly.

- ⓘ If the compressor works constantly or starts up several times per minute, electronic level control is malfunctioning.

Depending on the vehicle equipment, electronic level control switches between manual and automatic mode depending on either the vehicle speed or the position of the parking brake.

If electronic level control switches depending on vehicle speed, manual operation is automatically activated when the vehicle is stationary. You may raise or lower the vehicle level. If you subsequently drive faster than 10 km/h manual mode is automatically deactivated and automatic mode sets the vehicle level.

If electronic level control switches depending on the parking brake position, manual mode is automatically activated when the parking brake is applied. You may raise or lower the vehicle level to load and unload. If you release the parking brake, manual mode is automatically deactivated and automatic mode sets the driving level.

When working on the vehicle or changing a wheel, you can deactivate electronic level control (→ page 131).

If electronic level control is malfunctioning or the vehicle level is too high or too low, an audible signal sounds.

The driving and steering characteristics of the vehicle will be noticeably different. Electronic level control adjusts the vehicle level to the normal level as soon as possible. Continue driving carefully until the audible signal stops. Only then is the vehicle at normal level.

Automatic mode and electronic level control automatically switch on again to restore the vehicle level, depending on the option selected:

- when the parking brake is released
- from speeds of approximately 10 km/h

If the electronic level control compressor threatens to overheat, e.g. due to repeated raising or

lowering within a short period, electronic level control is automatically deactivated (play protection). You can raise or lower the vehicle level again after approximately one minute.

## Raising and lowering the vehicle level

### By remote control

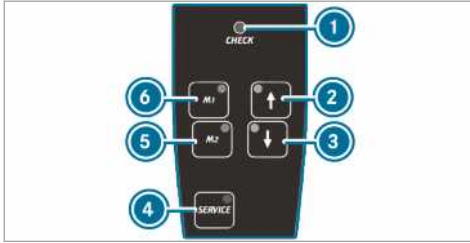

Electronic level control performs a self-check regularly when it is activated and while in use. Indicator lamp ① on the remote control lights up for approximately one second when you switch on either the ignition or electronic level control with button ④.

There is a malfunction if indicator lamp ① behaves in the following ways:

- the indicator lamp does not light up when you switch on the ignition or electronic level control  
or
- the indicator lamp does not go out after one second  
or
- the indicator lamp then lights up again or flashes

In addition, a warning tone is emitted from the remote control for approximately 30 seconds. The fault that has been detected can be shown using the indicator lamps (signalling of fault codes).

- ▶ Park the vehicle, leaving the ignition switched on.
- ▶ **To raise or lower the vehicle level:** press and hold button ② or ③ until the vehicle level reaches the desired height. The indicator lamp on button ② or ③ flashes as long as the vehicle level is being changed. When the vehicle level has been set, the indicator lamp on button ② or ③ lights up.

- ▶ **To lower automatically:** briefly press button ③.

Electronic level control automatically lowers the vehicle down to the lowest position.

The indicator lamp on button ③ flashes as long as the vehicle level is being changed. When the vehicle level has been set, the indicator lamp on button ③ lights up.

- ▶ To stop the movement, briefly press button ②.
- ▶ **To raise or lower to driving level:** briefly press button ② or ③. Electronic level control automatically raises or lowers the vehicle to driving level. The indicator lamp on button ② or ③ flashes as long as the vehicle level is being changed. When the vehicle level has been set, the indicator lamp on button ② or ③ lights up.
- ▶ To stop the movement, briefly press the other button.

- ▶ **To save the set vehicle level:** set the required vehicle level. Press and hold button ⑤ or ⑥ until you hear a tone. The vehicle level set has been saved on corresponding button ⑤ or ⑥.

- ▶ **To call up the saved vehicle level:** briefly press button ⑤ or ⑥. Electronic level control automatically raises or lowers the vehicle to the saved driving level. The indicator lamp on button ⑤ or ⑥ flashes as long as the vehicle level is being changed. When the vehicle level has been set, the indicator lamp on button ⑤ or ⑥ lights up.

- ▶ To stop the movement, briefly press button ② or ③.

- ▶ **To switch on automatically:** drive at over 10 km/h or release the parking brake. Electronic level control controls the vehicle level automatically.

- ▶ To stop the movement, briefly press button ② or ③.

### Switching electronic level control off/on

- ▶ **To switch electronic level control off:** press button ④. The indicator lamp on button ④ lights up.



- ▶ **To switch electronic level control on again:** press button ④ again.  
The indicator lamp on button ④ goes out.

### Using the button in the control panel

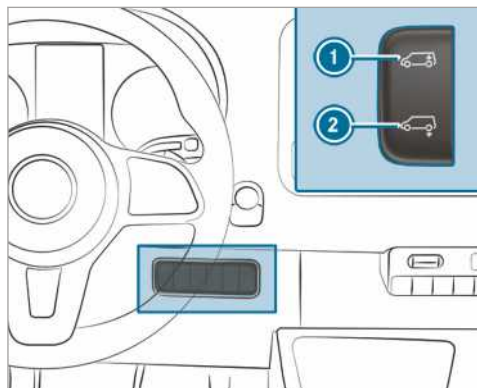

- ▶ Park the vehicle, leaving the ignition switched on.
- ▶ **To lower automatically:** briefly press the lower section of switch ②.  
Electronic level control automatically lowers the vehicle.
- ▶ To stop the movement, briefly press the upper section of switch ①.
- ▶ **To raise to driving level:** briefly press the upper section of switch ①.  
Electronic level control automatically raises the vehicle to the driving level.
- ▶ To stop the movement, briefly press the lower section of switch ②.
- ▶ **To switch on automatic mode:** drive at a speed above 10 km/h or release the parking brake.  
Electronic level control controls the vehicle level automatically.

### Charging the system in an emergency

Vehicles with valves for electronic level control emergency charging only. If electronic level control

is malfunctioning and the vehicle is leaning, you can raise or lower the vehicle by connecting an external compressed-air source to one of the emergency valves (tyre valves). If electronic level control is deactivated, you can drive on carefully to the nearest qualified specialist workshop and have the malfunction remedied.

**NOTE** Damage due to pressure being too high.

If the pressure in the air suspension bellows is too high, the compressed-air lines or the air suspension bellows may be damaged.

- ▶ Ensure you observe the maximum permissible operating pressure of 600 kPa (6 bar/87 psi).

- ▶ Apply the parking brake.
- ▶ **Vehicles with automatic transmission:** shift the transmission to position **P**.
- ▶ Switch off electronic level control (→ page 131).
- ▶ Switch off the engine and open the bonnet (→ page 270).
- ▶ Unscrew the valve cap of the corresponding valve.
- ▶ Connect the external compressed-air source.
- ▶ Raise or lower the vehicle level by charging or releasing compressed air until the driving level has been reached and the vehicle is in a horizontal position. While doing so, ensure you observe the maximum permissible operating pressure of 600 kPa (6 bar/87 psi).
- ▶ Disconnect the external compressed-air source.
- ▶ Tighten the valve caps on the valves.
- ▶ Close the bonnet (→ page 270).
- ▶ Drive on carefully to the nearest qualified specialist workshop.

### Problems with the electronic level control

Problem	Possible causes/consequences and ▶ Solutions
You cannot raise or lower the vehicle level when stationary.	The compressor is in danger of overheating. After repeatedly raising and lowering the vehicle, electronic level control (play protection) is deactivated.

Problem	Possible causes/consequences and ► Solutions
	<ul style="list-style-type: none"> <li>► Try to set the vehicle level manually again after approximately one minute.</li> </ul> <p>Electric level control has been deactivated due to undervoltage. The battery may not be charging.</p> <p>Handling and ride comfort may suffer.</p> <ul style="list-style-type: none"> <li>► Start the engine.</li> <li>► Consult a qualified specialist workshop as soon as possible.</li> </ul>

## Refuelling

### Refuelling the vehicle

**▲ WARNING** Risk of fire or explosion from fuel

Fuels are highly flammable.

- Fire, naked flames, smoking and creating sparks must be avoided.
- Switch off the ignition and, if it has been in use, switch off the stationary heater before you refuel your vehicle.

**▲ WARNING** Risk of injury from fuels

Fuels are poisonous and hazardous to your health.

- Do not swallow fuel or let it come into contact with skin, eyes or clothing.
- Do not inhale fuel vapour.
- Keep children away from fuel.
- Keep doors and windows closed during the refuelling process.

If you or other people come into contact with fuel, observe the following:

- Immediately rinse fuel off your skin with soap and water.
- If fuel comes into contact with your eyes, immediately rinse them thoroughly with clean water. Seek medical attention immediately.
- If you swallow fuel, seek medical attention immediately. Do not induce vomiting.
- Change immediately out of clothing that has come into contact with fuel.

**▲ WARNING** Risk of fire and explosion due to electrostatic charge

Electrostatic charge can create sparks and thereby ignite fuel vapours.

- Before you open the fuel filler cap or take hold of the pump nozzle, touch the metallic vehicle body. This discharges any electrostatic charge that may have built up.
- Do not get into the vehicle again during the refuelling process. Otherwise, electrostatic charge could build up again.

**▲ WARNING** Risk of fire from fuel mixture

Vehicles with a diesel engine:

If you mix diesel fuel with petrol, the flash point of the fuel mixture is lower than that of pure diesel fuel.

While the engine is running, component parts in the exhaust system may overheat without warning.

- Never refuel using petrol.
- Never mix petrol with diesel fuel.

**! NOTE** Do not use petrol to refuel vehicles with a diesel engine.

If you accidentally refuel with the wrong fuel:

- Do not switch on the ignition. Otherwise, fuel can enter the fuel system.
- Even small amounts of the wrong fuel could result in damage to the fuel system and the engine. The repair costs are high.
- Contact a qualified specialist workshop.
  - Have the fuel tank and fuel lines drained completely.

- !** **NOTE** Damage to the fuel system caused by overfilled fuel tanks.
  - ▶ Only fill the fuel tank until the pump nozzle switches off.
- !** **NOTE** Fuel may spray out when you remove the fuel pump nozzle.
  - ▶ Only fill the fuel tank until the pump nozzle switches off.
- !** **Note** Damage to painted surfaces due to fuel
  - ▶ Do not spill any fuel on painted surfaces.
- 🔥 ENVIRONMENTAL NOTE** Environmental damage due to improper handling of fuel
 

If fuels are handled improperly, they pose a danger to persons and the environment.

  - ▶ Do not allow fuels to run into the sewage system, the surface waters, the ground water or into the ground.

**Requirements:**

- the vehicle is unlocked.
- the auxiliary heating is deactivated.
- the front left-hand door is open.
- i** Do not get back into the vehicle during the refuelling process. Otherwise, electrostatic charge could build up again.

Observe the notes on operating fluids (→ page 335).

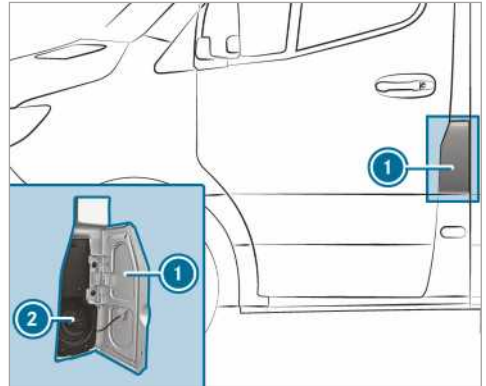

- 1** Fuel filler flap
- 2** Fuel filler cap
- ▶ Open fuel filler flap **1**.
- ▶ Turn fuel filler cap **2** anti-clockwise and remove it.
- ▶ Close all vehicle doors to prevent fuel vapours from entering the vehicle interior.
- ▶ Completely slide the filler neck of the pump nozzle into the tank, hook in place and refuel.
- ▶ Fill the fuel tank only until the pump nozzle switches off.
- ▶ Replace fuel filler cap **2** and turn it clockwise. You will hear a click when the fuel filler cap is closed fully.
- ▶ Open the front left-hand door.
- ▶ Close fuel filler flap **1**.
- i** **Vehicles with a diesel engine and incorrect fuelling protector against refuelling with petrol:** the filler neck is designed for refuelling at diesel filling pumps.
- i** **Vehicles with a diesel engine:** if the fuel tank has been run completely dry, top up with at least 5 l of diesel.

**Problems with the fuel and fuel tank**

Problem	Possible causes/consequences and ▶ Solutions
Fuel is leaking from the vehicle.	The fuel line or the fuel tank is faulty. <ul style="list-style-type: none"> <li>▶ Apply the parking brake.</li> <li>▶ Switch off the engine.</li> <li>▶ Remove the key from the ignition lock.</li> </ul> Or, on vehicles with KEYLESS-GO:

Problem	Possible causes/consequences and ► Solutions
	<ul style="list-style-type: none"> <li>► open the driver's door. The on-board electronics are in position <b>0</b>. This corresponds to the "pulled-out key".</li> <li>► Do not restart the engine under any circumstances.</li> <li>► Consult a qualified specialist workshop.</li> </ul>
The engine does not start.	<p>The fuel tank of a vehicle with a diesel engine has been run completely dry.</p> <ul style="list-style-type: none"> <li>► Refuel the vehicle with at least 5 l of diesel.</li> <li>► Switch the ignition on for approximately ten seconds.</li> <li>► Start the engine continuously for a maximum of ten seconds until it runs smoothly.</li> </ul> <p>If the engine does not start:</p> <ul style="list-style-type: none"> <li>► switch the ignition on for approximately ten seconds.</li> <li>► start the engine continuously for a maximum of ten seconds until it runs smoothly.</li> </ul> <p>If the engine does not start after three attempts:</p> <ul style="list-style-type: none"> <li>► Consult a qualified specialist workshop.</li> </ul>

## AdBlue®

### Notes on AdBlue®

**!** **NOTE** When you open the AdBlue® tank, small amounts of ammonia vapour may escape.

- Only fill the AdBlue® tank in well-ventilated areas.
- Do not let AdBlue® come into contact with skin, eyes or clothes.
- Keep AdBlue® away from children.

**!** **NOTE** Do not ingest AdBlue®.

If AdBlue® is swallowed:

- Immediately rinse out your mouth thoroughly.
- Drink plenty of water.
- Seek medical attention immediately.

**!** **NOTE** Damage due to additives in AdBlue® or diluting AdBlue®

AdBlue® exhaust gas aftertreatment system can be destroyed by:

- additives in AdBlue®
- diluting AdBlue®

- Only use AdBlue® in accordance with ISO 22241.
- Do not add additives.
- Do not dilute AdBlue®.

**!** **NOTE** Damage and malfunctions due to impurities in AdBlue®

Impurities in AdBlue® lead to:

- increased emission values
- damage to the catalytic converter
- engine damage
- malfunctions of the AdBlue® exhaust gas aftertreatment system

- Avoid impurities in AdBlue®.

**!** **NOTE** AdBlue® residue crystallises after some time. Remove AdBlue® residue.

- ▶ Immediately rinse surfaces that come in contact with AdBlue® when filling with water.
- ▶ AdBlue® can also be removed with a damp cloth and cold water.
- ▶ If AdBlue® has already crystallised, clean using a sponge and cold water.

AdBlue® is a liquid urea solution used for exhaust gas aftertreatment of diesel engines. In order for the exhaust gas aftertreatment to function properly, only use AdBlue® in accordance with ISO 22241.

AdBlue® has the following properties:

- non-toxic
- colourless and odourless
- non-flammable

AdBlue® availability

- you can have AdBlue® refilled by fast service at a qualified specialist workshop, e.g. a Mercedes-Benz Service Centre.
  - AdBlue® is available at numerous filling stations via AdBlue® filling pumps.
  - alternatively, AdBlue® is available at qualified specialist workshops, e.g. a Mercedes-Benz Service Centre, and at numerous filling stations as an AdBlue® refill canister or AdBlue® refill bottle.
- i** AdBlue® freezes at a temperature of approximately -11 °C. The vehicle is equipped with an AdBlue® preheating system at the factory. This means that winter operation is also ensured for temperatures below -11 °C. If you top up AdBlue® at temperatures below -11 °C, the AdBlue® level in the instrument cluster may not be displayed correctly. If the AdBlue® is frozen, drive for at least 20 minutes and then park the vehicle for a minimum of 30 seconds, so that the level is correctly displayed. In extreme winter conditions, the time needed to detect the top-up amount may be considerably longer. Park the vehicle in a warm garage to speed up this process.
- i** Ensure the connection between the refill container and vehicle filler neck does not drip.

## Topping up AdBlue®

**!** **NOTE** Engine damage due to AdBlue® being in the fuel

- ▶ AdBlue® must not be used to fill the fuel tank.
- ▶ Only use AdBlue® to fill the AdBlue® tank.
- ▶ Do not overfill the AdBlue® tank.

**!** **NOTE** Contamination of the vehicle interior due to AdBlue® leakage

- ▶ After topping up, carefully close the AdBlue® refill container.
- ▶ Avoid carrying AdBlue® refill containers permanently in the vehicle.

## Requirements:

- the ignition is switched off

Vehicles with passenger vehicle approval: the following messages that appear in succession in the multifunction display indicate that you need to refill the AdBlue® tank:

- **Top up AdBlue** See [Owner's Manual](#)  
The AdBlue® tank has dropped to the reserve level.
- **Top up AdBlue Performance reduced in XXX miles**  
You will only be able to drive the vehicle the distance shown. Refill AdBlue® as quickly as possible.
- **Top up AdBlue Perf. reduced: 12 mph No start in XXX miles**  
Vehicle speed is limited to approximately 20 km/h. You will only be able to drive the vehicle the distance shown. Subsequently, it will no longer be possible to start the engine.
- **Refill AdBlue Engine start not possible**  
The vehicle can no longer be started.

Vehicles with commercial vehicle approval: the following messages that appear in succession in the multifunction display indicate that you need to refill the AdBlue® tank:

- **Top up AdBlue** See [Owner's Manual](#)  
The AdBlue® tank has dropped to the reserve level.

- Top up AdBlue Power reduced
- Top up AdBlue Performance reduced after eng. restart: 12 mph  
The vehicle cannot be driven at a speed exceeding 20 km/h after engine restart.
- Top up AdBlue Performance reduced: 12 mph  
The vehicle cannot be driven at a speed exceeding 20 km/h.

### Opening the AdBlue® filler cap on filler caps that are not lockable

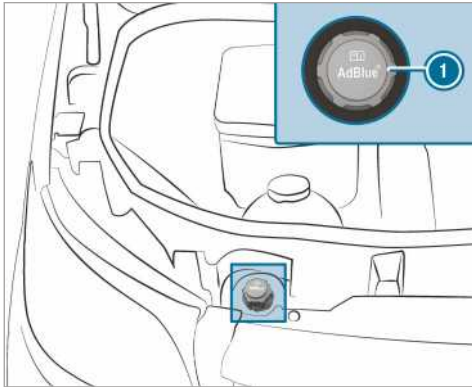

- ▶ Open the bonnet.
- ▶ Turn AdBlue® filler cap ① anti-clockwise and remove it.

### Opening the AdBlue® filler cap on lockable filler caps

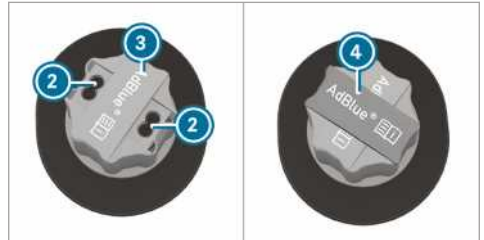
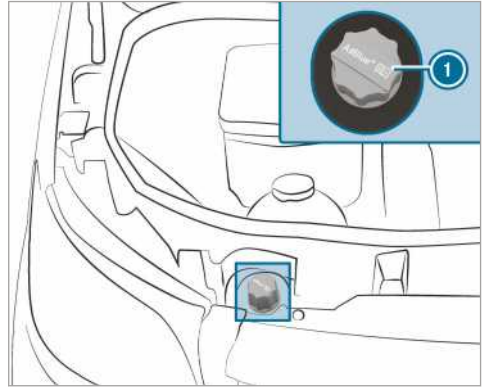

- ▶ Open the bonnet.
- ▶ Take tool ④ for unlocking the AdBlue® filler cap ① from the vehicle tool kit.
- ▶ Pull cover ③ on AdBlue® filler cap ① up, turn 90° and release.
- ▶ Insert tool ④ in holes ② of AdBlue® filler cap ①.
- ▶ Turn AdBlue® filler cap ① anti-clockwise and remove it.

### Preparing the AdBlue® refill canister



Variant 1



Variant 2

- ▶ Unscrew the cap on AdBlue® refill canister ②.
- ▶ Screw disposable hose ① onto the opening of AdBlue® refill canister ② until hand-tight.

### Topping up AdBlue®

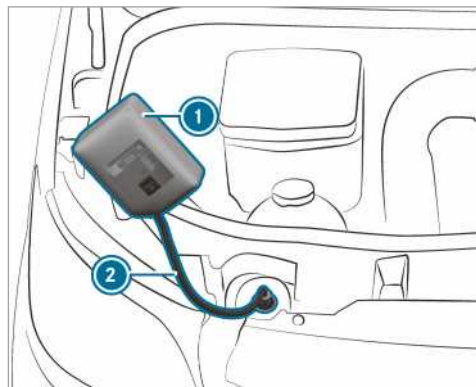

Variant 1

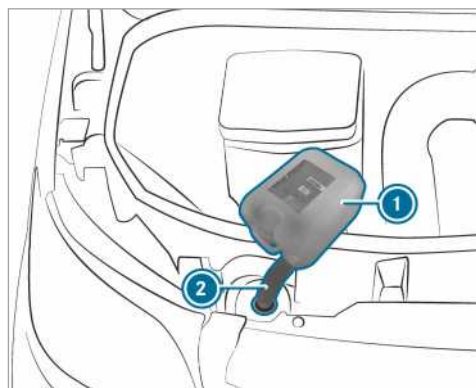

Variant 2

- ▶ Screw disposable hose ② onto the filler neck of the vehicle until hand-tight.
  - ▶ Lift up and tip AdBlue® refill canister ①. The filling process stops when the AdBlue® tank is completely full. AdBlue® refill canister ② can be removed when it has been only partially emptied.
  - ▶ Unscrew and close disposable hose ② and AdBlue® refill canister ① in reverse order.
  - ▶ Switch on the ignition for at least 60 seconds.
  - ▶ Start the vehicle.
- ⓘ Avoid storing AdBlue® containers permanently in the vehicle.

**AdBlue® refill bottle**

Only screw the AdBlue® refill bottle on hand-tight. It may otherwise be damaged.



AdBlue® refill bottles ① can be obtained at many filling stations or at a Mercedes-Benz service centre. Refill bottles without a threaded cap offer no overfill protection. AdBlue® may leak out as a result of overfilling. Mercedes-Benz offers special refill bottles with a threaded cap. These are available at any Mercedes-Benz service centre.

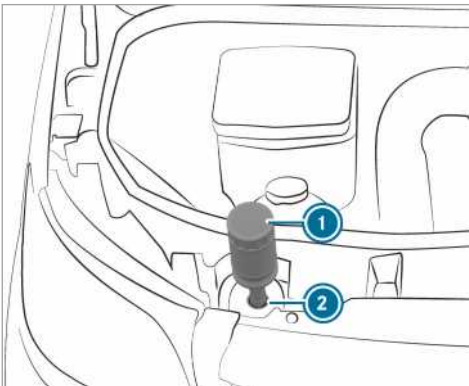

- ▶ Unscrew the protective cap from AdBlue® refill bottle ①.
- ▶ Place AdBlue® refill bottle ① as shown on filler opening ② and screw it on clockwise until hand-tight.
- ▶ Press AdBlue® refill bottle ① towards filler opening ②. The AdBlue® tank is filled. This could take up to one minute.

① When the AdBlue® refill bottle is no longer pressed down, filling stops. The bottle can be removed when it has been only partially emptied.

- ▶ Release AdBlue® refill bottle ①.
- ▶ Turn AdBlue® refill bottle ① anti-clockwise and remove it.
- ▶ Screw the protective cap onto AdBlue® refill bottle ① again.

**Filling procedure with the pump nozzle of an AdBlue® filling pump**

- ▶ Insert the pump nozzle into the filler neck and top up with AdBlue®. When doing so, do not overfill the AdBlue® tank.
- ▶ If the pump nozzle switches off during filling, do not continue the filling procedure. The AdBlue® tank is completely full.

① You can also use an AdBlue® filling pump for lorries.

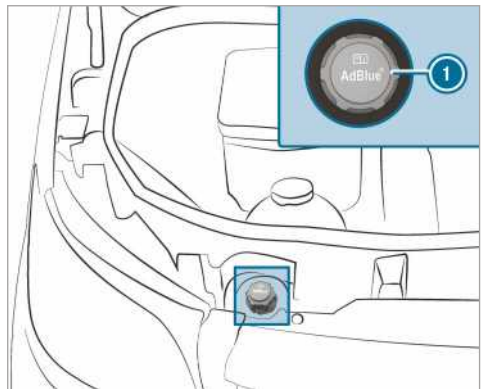
**Closing the AdBlue® filler cap on filler caps that are not lockable**

- ▶ After filling the AdBlue® tank, place AdBlue® filler cap ① on the filler neck and turn it clockwise.
- ▶ Turn the AdBlue® filler cap until the lettering is legible and horizontal. The filler neck is only locked correctly when this is the case.
- ▶ Close the bonnet.



### Closing the AdBlue® filler cap on lockable filler caps

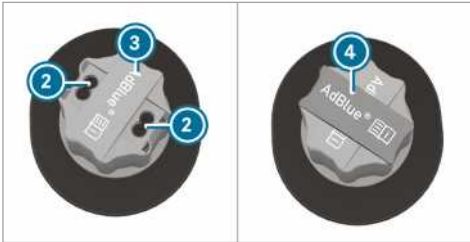
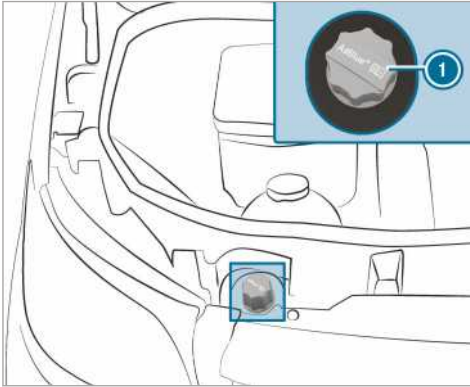

- ▶ After filling the AdBlue® tank, place AdBlue® filler cap ① on the filler neck and turn it clockwise.
- ▶ Remove tool ④ from AdBlue® filler cap ① and store it in the vehicle tool kit.
- ▶ Pull cover ③ on AdBlue® filler cap ① up over holes ② of AdBlue® filler cap ①, turn and release.
- ▶ Turn AdBlue® filler cap ①. If AdBlue® filler cap ① turns freely, the AdBlue® tank is closed.

## Parking

### Parking the vehicle

**⚠ WARNING** Risk of fire caused by hot exhaust system parts

Flammable material such as leaves, grass or twigs may ignite if they come into contact with hot parts of the exhaust system or exhaust gas flow.

- ▶ Park the vehicle so that no flammable material can come into contact with hot vehicle components.
- ▶ In particular, do not park on dry grass-land or harvested grain fields.

**⚠ WARNING** Risk of accident and injury due to children left unattended in the vehicle

If children are left unattended in the vehicle, they could:

- open doors, thereby endangering other persons or road users.
- get out of the vehicle and be hit by oncoming traffic.
- operate vehicle equipment and become trapped, for example.

In addition, children could also set the vehicle in motion, for example, by:

- releasing the parking brake.
- shifting the automatic transmission out of park position **P** or shifting manual transmission into neutral.
- starting the engine.

- ▶ When leaving the vehicle, always take the key with you and lock the vehicle.
- ▶ Never leave children and animals unattended in the vehicle.
- ▶ Keep the vehicle key out of reach of children.

**! NOTE** Damage to the vehicle or the drivetrain due to rolling away

- ▶ Always park your vehicle safely and according to legal requirements.
- ▶ Always properly secure the vehicle against rolling away.

**⚠ WARNING** Risk of accident and injury if parking brake is not applied

If you park the vehicle with the transmission in park position **P** and the parking brake is not engaged, the vehicle may roll away.

Engaging park position **P** is not a fully adequate replacement for the parking brake.

There is a risk of accident and injury!

- ▶ Secure the vehicle against rolling away as described below.

Observe the following points to ensure that the vehicle is properly secured against rolling away unintentionally:

- ▶ apply the parking brake.
  - ▶ **Vehicles with manual transmission:** engage first or reverse gear.
  - ▶ **Vehicles with automatic transmission:** engage transmission position **P**.
  - ▶ **On uphill or downhill inclines:** turn the front wheels towards the kerb.
  - ▶ **On uphill or downhill inclines:** secure the rear axle with a chock or an object without sharp edges (→ page 145).
- i** You can operate the side windows for five minutes after you have switched off the vehicle.

## Manual parking brake

### Applying or releasing the handbrake lever

- ⚠ WARNING** Risk of skidding or an accident by braking with the parking brake

If you have to brake your vehicle with the parking brake, the braking distance is considerably longer and the wheels may lock. There is an increased risk of skidding and/or accident.

- ▶ Only brake the vehicle with the parking brake if the service brake has failed.
- ▶ In this case, do not apply the parking brake with too much force.
- ▶ If the wheels lock, immediately release the parking brake as much as required for the wheels to turn again.

- ⚠ WARNING** Risk of fire and an accident if the parking brake is not released

If the parking brake is not fully released when driving, the following situations can occur:

- the parking brake can overheat and cause a fire
  - the parking brake can lose its holding function
- ▶ Completely release the parking brake before driving off.

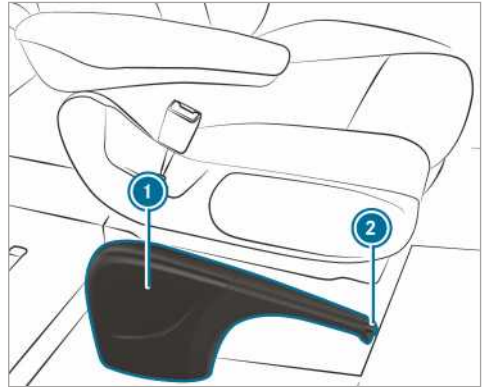

The brake lights do not light up when you brake the vehicle with the parking brake.

Generally, you may only apply the parking brake when the vehicle is stationary.

- ▶ **To apply the parking brake:** pull handbrake lever **1** up as far as the last possible detent. When the engine is running, the **(P)** indicator lamp lights up in the instrument display. If the vehicle is in motion, a warning tone sounds.

- i** In vehicles with a folding handbrake lever, you can then press handbrake lever **1** down as far as it will go.

- ▶ **To release the parking brake:** in vehicles with a folding handbrake lever, first pull handbrake lever **1** up as far as it will go.
- ▶ Pull handbrake lever **1** slightly and press release knob **2**.
- ▶ Guide handbrake lever **1** down to as far as it will go.  
The **(P)** indicator lamp in the instrument display goes out.

### Folding the handbrake lever up or down (only in vehicles with a folding handbrake lever)

#### Requirements:

- The handbrake lever is applied.
- ▶ **To fold down the handbrake lever:** push the handbrake lever down as far as it will go.
  - ▶ **To raise the handbrake lever:** pull the handbrake lever up as far as it will go.

## Emergency braking

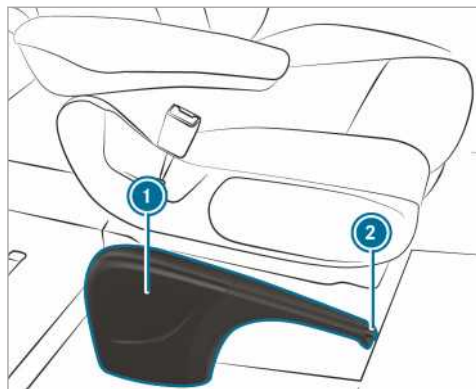

If, in exceptional cases, the service brake fails, you may use the parking brake to perform emergency braking.

► **Emergency braking:** press and hold release button ② and carefully pull brake lever ①.

## Electric parking brake

### Information on the electric parking brake

**▲ WARNING** Risk of accident and injury due to children left unattended in the vehicle

If you leave children unattended in the vehicle, they may be able to set the vehicle in motion, for example by:

- releasing the parking brake.
- shifting the automatic transmission out of park position **P** or shifting manual transmission into idle position.
- starting the engine.

In addition, they may operate vehicle equipment and become trapped.

- Never leave children unattended in the vehicle.
- When leaving the vehicle, always take the key with you and lock the vehicle.

For the automatic functions to work correctly, the driver must be seated in the correct seat position (→ page 60).

The function of the electric parking brake is dependent on the on-board electrical system voltage. If the on-board electrical system voltage is

low or there is a malfunction in the system, it may not be possible to apply the electric parking brake and the yellow **(P)** indicator lamp lights up.

In this case:

- Park the vehicle on level ground and secure it to prevent it from rolling away.
- **Vehicles with automatic transmission:** shift the transmission to position **P**.
- **Vehicles with manual transmission:** engage first gear.

**i** The electric parking brake is only actually applied when the red **(P)** indicator lamp lights up continuously.

It may not be possible to release a parking brake if the on-board electrical system voltage is low or if there is a malfunction in the system. Inform a qualified specialist workshop. When the engine is switched off, the electric parking brake carries out a function test at regular intervals. Noises are normal in this process.

### Automatically applying the electric parking brake

#### Vehicles with automatic transmission:

The electric parking brake is automatically applied when the transmission is in position **P** and:

- the engine is switched off  
or
- the driver leaves the seat  
or
- the belt buckle is undone

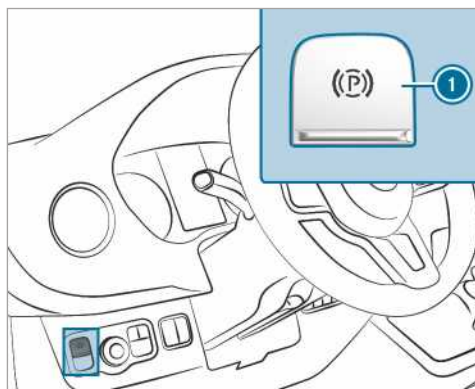

To prevent the electric parking brake from applying automatically, pull switch ①.

The electric parking brake is also automatically applied if Active Distance Assist DISTRONIC has brought the vehicle to a standstill.

In addition, at least one of the following conditions must be fulfilled:

- the engine is switched off
- the driver is not sitting in the driver's seat
- the belt buckle is undone
- there is a system malfunction
- the power supply is insufficient
- the vehicle is stationary for a long time

The red (P) indicator lamp in the instrument display lights up. The electric parking brake is only actually applied when the red (P) indicator lamp lights up continuously.

The electric parking brake is not automatically applied if the engine is switched off by the ECO start/stop function.

#### Vehicles with manual transmission:

The electric parking brake is automatically applied if:

- the engine is switched off  
or
- the driver leaves the driver's seat  
or
- the belt buckle is undone

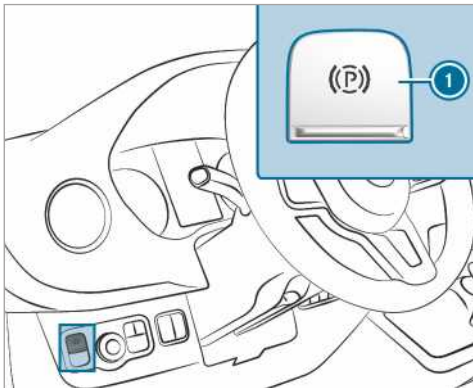

To prevent the electric parking brake from applying automatically, pull switch ①.

The electric parking brake is not automatically applied if the engine is switched off by the ECO start/stop function.

#### Releasing the electric parking brake automatically

##### Vehicles with automatic transmission:

The electric parking brake of your vehicle is released when all of the following conditions are fulfilled:

- the driver is sitting in the driver's seat
- the driver is belted
- the engine is running
- the transmission is in position **D** or **R** and you depress the accelerator

or

you switch from transmission position **P** to position **D** or **R**. You must also depress the accelerator if travelling on steep uphill gradients.

- if the transmission is in position **R**, the rear doors must be closed

##### Vehicles with manual transmission:

The electric parking brake of your vehicle is released when all of the following conditions are fulfilled:

- the driver is sitting in the driver's seat
- the driver is belted
- the engine is running
- a gear is engaged
- you release the clutch pedal and depress the accelerator pedal at the same time
- when reverse gear is selected, the rear doors must be closed

#### Applying or releasing the electric parking brake manually

**▲ WARNING** Risk of accident and injury due to children left unattended in the vehicle

If you leave children unattended in the vehicle, they may be able to set the vehicle in motion, for example by:

- releasing the parking brake.
- shifting the automatic transmission out of park position **P** or shifting manual transmission into idle position.



- starting the engine.

In addition, they may operate vehicle equipment and become trapped.

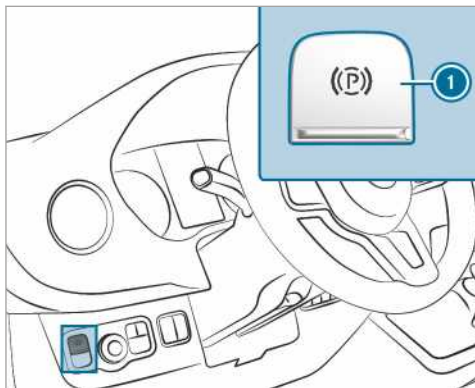
- ▶ Never leave children unattended in the vehicle.
- ▶ When leaving the vehicle, always take the key with you and lock the vehicle.



▶ **To apply:** press switch ①.

When the electric parking brake is applied, the red  indicator lamp lights up in the instrument display. The electric parking brake is only actually applied when the red  indicator lamp lights up continuously.

It is also possible to apply the electric parking brake when the ignition is switched off.

▶ **To release:** pull switch ①.

The red  indicator lamp in the instrument display goes out.

You may only release the electric parking brake if the ignition is switched on with the Start/Stop button.

## Emergency braking

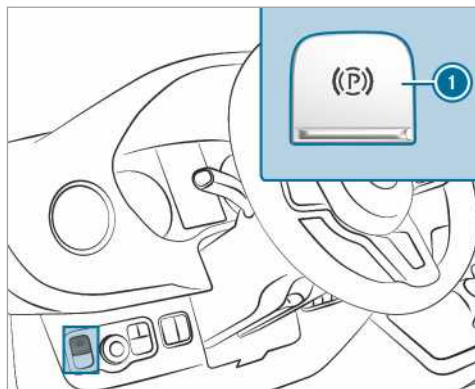

In the event of an emergency, you can brake the vehicle while it is in motion with the electric parking brake.

▶ While driving, press switch ① of the electric parking brake.

The vehicle is braked as long as you keep switch ① of the electric parking brake depressed.

The longer electric parking brake switch ① is depressed, the greater the braking force.

During the braking process:

- a warning tone sounds
- the "Release parking brake" message appears
- the red  indicator lamp in the instrument display flashes

When the vehicle has been braked to a standstill, the electric parking brake is applied.

## Parking up the vehicle

### Parking up the vehicle for longer than four weeks

- ▶ **Method 1:** connect the batteries to a trickle charger.
- ▶ **Method 2:** disconnect the vehicle starter battery.
- ▶ **Method 3:** switch off the power supply using the battery main switch and disconnect the auxiliary battery on the vehicle.
- ▶ **Method 4:** interrupt the power supply by activating standby mode (→ page 145)

The charge level of the battery must be checked every three weeks if no measures are taken to maintain the battery charge.

- ▶ **Battery voltage below 12.2 V:** charge the battery to prevent deep discharge damage.
- ⓘ Further information can be obtained at a qualified specialist workshop.

## Standby mode

### Activating/deactivating standby mode

#### Requirements:

- the engine is switched off.

On-board computer:

↳ Settings ▶ Vehicle ▶ Ruhezustand (Standby)

- ▶ **To activate/deactivate:** select **Yes** or **No**.

## Using the chock

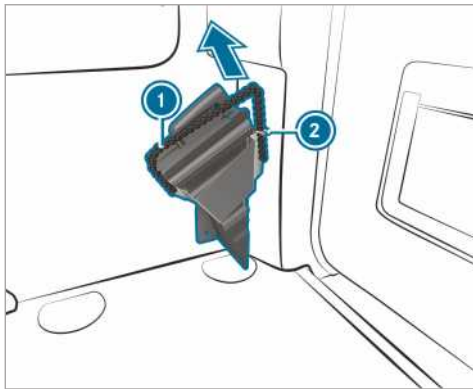

Use the chock to provide additional security to prevent the vehicle from rolling away, e.g. when parking or changing a wheel.

- ▶ **To remove the chock:** pull the holding rope ① slightly downwards and then remove it from bracket ②.
- ▶ Remove the chock.
- ⓘ When stowing it away, ensure that the chock has been secured in the bracket by the holding rope ①.

## Driving and driving safety systems

### Driving systems and your responsibility

Your vehicle is equipped with driving systems which assist you in driving, parking and manoeuvring the vehicle. The driving systems are tools and do not relieve you of your responsibility. Always pay attention to the traffic and intervene if necessary. Be aware of the limits of safe use of these systems.

### Function of the sensors

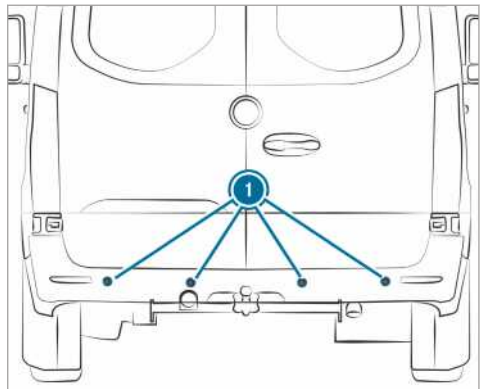

Certain driving and driving safety systems use sensors ① to monitor the area in front of, behind or next to the vehicle (depending on the vehicle's equipment).

Depending on the vehicle's equipment, the radar sensors are integrated behind the bumpers and/or behind the radiator grille. Keep these parts free of dirt, ice and slush (→ page 279). The sensors must not be covered, for example by bicycle racks, overhanging loads or stickers. After a collision, have the function of the radar sensors checked at a qualified specialist workshop as damage (both visible or non-visible) may have occurred to the bumper or radiator trim.

### Function of driving systems and driving safety systems

In this section, you will find information about the following driving systems and driving safety systems:

- ABS (**A**nti-**l**ock **b**raking system) (→ page 146)
- ASC (**A**cceleration **S**kid **C**ontrol) (→ page 146)

- BAS (Brake Assist System) (→ page 146)
- ESP® (Electronic Stability Program) (→ page 147)
- EBD (Electronic Brakeforce Distribution) (→ page 148)
- Active Brake Assist (→ page 148)
- Adaptive brake lights (→ page 150)
- Cruise control (→ page 150) and limiter (→ page 151)
- Active Distance Assist DISTRONIC (→ page 153)
- Hill start assist
- HOLD function (→ page 155)
- Parking Assist PARKTRONIC (→ page 155)
- Reversing camera (→ page 157)
- 360° Camera (→ page 159)
- ATTENTION ASSIST (→ page 161)
- Traffic Sign Assist (→ page 162)
- Blind Spot Assist (→ page 164)
- Active Lane Keeping Assist (→ page 166)

### Functions of ABS (Anti-lock Braking System)

Observe the important safety guidelines for the driving safety system.

ABS controls the brake pressure in critical situations:

- the wheels are prevented from locking when braking, e.g. during maximum full-stop braking or when there is insufficient tyre traction
- the steerability of the vehicle in terms of physical possibilities is ensured when braking
- ABS is active from speeds of approx. 5 km/h. On a slippery road surface, ABS intervenes even if you only brake gently.

#### System limitations

If there is a malfunction and the yellow  ABS warning lamp lights up continuously in the instrument display after starting the engine, ABS may be impaired or without function.

If ABS intervenes, you will feel a pulsing in the brake pedal. The pulsating brake pedal may be an indication of hazardous road conditions and functions as a reminder to take extra care while driving.

**If ABS intervenes:** keep the brake pedal firmly depressed until the braking situation has passed.

**To make a full brake application:** depress the brake pedal with full force.

### Function of BAS (Brake Assist System)

**▲ WARNING** Risk of an accident caused by a malfunction in BAS (Brake Assist System)

If BAS is malfunctioning, the braking distance in an emergency braking situation is increased.

▶ Depress the brake pedal with full force in emergency braking situations. ABS prevents the wheels from locking.

BAS supports you with additional braking force in an emergency braking situation.

If you depress the brake pedal quickly, BAS is activated:

- BAS automatically boosts the braking force of the brakes
- BAS can shorten the braking distance
- ABS prevents the wheels from locking

When you release the brake pedal, the brakes function as usual again. BAS is deactivated.

### Functions of ASC (Acceleration Skid Control)

ASC can neither reduce the risk of an accident nor override the laws of physics if the driver does not pay attention when pulling away or accelerating. ASC is only an aid. Always adapt your driving style to suit the prevailing road and weather conditions.

If you activate or deactivate the all-wheel drive in a vehicle with this option, ASC will be deactivated for the duration of the activation/deactivation process.

Vehicles without steering wheel buttons: if ASC is malfunctioning, the  indicator lamp lights up while the engine is running and the engine output may be reduced (→ page 23).

ASC improves traction, i.e. the transfer of power from the tyres to the road surface, for a sustained period and, thereby, also improves the driving stability of the vehicle. If the driving wheels start to spin, ASC brakes individual drive wheels and limits the engine torque. ASC thus significantly assists you when pulling away and accelerating, especially on wet or slippery roads.



If traction on the road surface is not sufficient, even ASC will not allow you to pull away without difficulty. The type of tyres and total weight of the vehicle as well as the gradient of the road also play a crucial role.

If ASC intervenes, the  warning lamp in the instrument display flashes.

## Functions of ESP® (Electronic Stability Program)

**⚠ WARNING** Risk of skidding if ESP® is malfunctioning

If ESP® is malfunctioning, ESP® cannot carry out vehicle stabilisation. In addition, other driving safety systems are switched off.

- ▶ Drive on carefully.
- ▶ Have ESP® checked at a qualified specialist workshop.

**⚠ WARNING** Risk of skidding if ESP® is deactivated

If you deactivate ESP®, ESP® cannot carry out vehicle stabilisation.

- ▶ ESP® should only be deactivated in the following situations.

Do not operate the vehicle on a roller dynamometer (e.g. for a performance test). If you have to operate the vehicle on a roller dynamometer, consult a qualified specialist workshop beforehand.

If you activate or deactivate the all-wheel drive in a vehicle with this option, ESP® will be deactivated for the duration of the activation/deactivation process.

If ESP® is malfunctioning or deactivated, the  warning lamp lights up while the engine is running and the engine output may be reduced (→ page 23).

- ⓘ Use only wheels with the recommended tyre sizes. Only then will ESP® function properly.

## Activating or deactivating ESP® (Electronic Stability Program)

Multimedia system:

  Settings  Quick access  ESP

- ⓘ ESP® can only be activated and deactivated via quick access when at least one other function is available in quick access. Otherwise, you can find ESP® in the Assistance menu.

- ▶ Select ESP.  
A prompt appears.
- ▶ Select On or  Off.

If the  ESP® OFF warning lamp lights up constantly in the instrument cluster, ESP® is deactivated.

Observe the information on warning lamps and display messages which may be shown in the instrument cluster.

## Functions of ESP® Crosswind Assist

Crosswind Assist does not work if ESP® is deactivated or disabled due to a malfunction.

Crosswind Assist does not react:

- in the event of severe jolts and vibrations, e.g. as a result of uneven surfaces or pot-holes
- if the vehicle loses traction, e.g. on snow or ice or when aquaplaning
- in the event of sudden or large steering movements by the driver

Crosswind Assist is operational again as soon as the driving conditions return to normal.

Crosswind Assist detects strong crosswind gusts that can impair the roadholding of your vehicle when driving straight ahead. Crosswind Assist intervenes depending on the direction and strength of the crosswind.

A stabilising brake application helps you to keep the vehicle on track.

Information is shown in the instrument cluster in the event of a clearly discernible intervention by Crosswind Assist.

Crosswind Assist is active above a vehicle speed of 80 km/h when the vehicle is driving straight ahead or cornering gently.



## Function of ESP® trailer stabilisation

### **▲ WARNING** Risk of accident in poor road and weather conditions

In poor road and weather conditions, the trailer stabilisation cannot prevent lurching of the vehicle/trailer combination. Trailers with a high centre of gravity may tip over before ESP® detects this.

- ▶ Always adapt your driving style to suit the current road and weather conditions.

ESP® trailer stabilisation counteracts critical driving situations in good time and thereby provides considerable assistance when driving with a trailer. Trailer stabilisation is part of ESP®.

If the sensor system and evaluation logic detect trailer swinging movements, ESP® trailer stabilisation initially brakes individual vehicle wheels in a targeted manner. It thus counteracts swinging movements. If the swinging movements do not stop, the vehicle is braked until the vehicle/trailer combination is stabilised. If necessary, the vehicle's engine output is limited.

If your vehicle with trailer (vehicle/trailer combination) starts to swerve, you are able to stabilise the vehicle/trailer combination only by braking. ESP® trailer stabilisation helps you to stabilise the vehicle/trailer combination in this situation.

ESP® trailer stabilisation is active above speeds of 65 km/h.

If ESP® is deactivated because of a malfunction, trailer stabilisation will not function.

## Function of EBD (Electronic Brakeforce Distribution)

EBD has the following characteristics:

- monitoring and controlling the braking force on the rear wheels
- improving driving stabilisation when braking, especially on bends

## Function of Active Brake Assist

Active Brake Assist consists of:

- Distance warning function
- Autonomous braking function
- Situation-dependent braking assistance

Active Brake Assist can help you to minimise the risk of a collision with vehicles or pedestrians or to reduce the effects of such a collision.

If Active Brake Assist has detected a risk of collision, you will be warned visually and acoustically.

If you do not react to the visual or acoustic warning, autonomous braking can be initiated in critical situations.

If there are pedestrians and cyclists crossing: in especially critical situations, Active Brake Assist can initiate autonomous braking directly. In this case, the visual and acoustic warning occurs simultaneously with the braking application.

If you apply the brake yourself in a critical situation, or apply the brakes during autonomous braking, situation-dependent braking assistance occurs. The brake pressure increases up to maximum full-stop braking if necessary. Situation-dependent braking assistance only intervenes when the brakes are applied firmly; otherwise, it remains within the autonomous braking process.

### **▲ WARNING** Risk of accident caused by limited detection performance of Active Brake Assist

Active Brake Assist cannot always clearly identify objects and complex traffic situations.

Due to the nature of the system, complex driving conditions may also cause Brake Assist to intervene or not intervene without reason. In such cases, and in the event of Active Brake Assist malfunctioning, the brake system will continue to be available with full brake boost and BAS.

- ▶ Always pay careful attention to the traffic situation; do not rely on Active Brake Assist alone. Active Brake Assist is only an aid. The driver of the vehicle is responsible for keeping a sufficiently safe distance to the vehicle in front, for vehicle speed and for braking in good time.
- ▶ Be prepared to brake or swerve if necessary.

Also observe the system limitations of Active Brake Assist.

**The individual subfunctions are available in the following speed ranges:**  
**Distance warning function**

The distance warning function issues a warning at speeds:

- from approximately 30 km/h, if over several seconds the distance maintained to the vehicle travelling in front is insufficient for the driven speed.

The  distance warning lamp then lights up in the instrument cluster.

- from approximately 7 km/h, if your vehicle is critically close to a vehicle or pedestrian.

An intermittent warning tone sounds and the  distance warning lamp lights up in the instrument cluster.

Brake immediately or take evasive action, provided it is safe to do so and the traffic situation allows this.

**The distance warning function can aid you in the following situations with an intermittent warning tone and a warning lamp:**

Vehicles travelling in front	Stationary vehicles	Crossing vehicles	Crossing pedestrians/cyclists	Stationary pedestrians
Up to approx. 250 km/h	Up to approx. 200 km/h	No reaction	Up to approx. 60 km/h	No reaction

### Autonomous braking function

The autonomous braking function may intervene at speeds starting from approximately 7 km/h in the following situations:

Vehicles travelling in front	Stationary vehicles	Crossing vehicles	Crossing pedestrians/cyclists	Stationary pedestrians
Up to approx. 250 km/h	Up to approx. 200 km/h	No reaction	Up to approx. 60 km/h	No reaction

### Situation-dependent braking assistance

Situation-dependent braking assistance may intervene at speeds starting from approximately 7 km/h in the following situations:

Vehicles travelling in front	Stationary vehicles	Crossing vehicles	Crossing pedestrians/cyclists	Stationary pedestrians
Up to approx. 250 km/h	Up to approx. 80 km/h	No reaction	Up to approx. 60 km/h	No reaction

### Cancelling a brake application of Active Brake Assist

You can cancel a brake application of Active Brake Assist at any time by:

- Fully depressing the accelerator pedal or with kickdown.
- Fully releasing the brake pedal (only during situation-dependent braking assistance).

Active Brake Assist may cancel the brake application when one of the following conditions is fulfilled:

- You manoeuvre to avoid the obstacle.

- There is no longer a risk of collision.
- An obstacle is no longer detected in front of your vehicle.

### System limitations

The system may be impaired or may not function in the following situations:

- In snow, rain, fog or heavy spray.
- The sensors are dirty, misted up, damaged or covered.
- The sensors are affected by interference from other radar sources, e.g. strong radar reflections in multi-storey car parks.

- If a loss of tyre pressure or a defective tyre has been detected and displayed.
- Full system performance is not available for a few seconds after switching on the ignition or after driving off.

The system may not react correctly in the following situations:

- In complex traffic situations, objects may not always be clearly detected.
- Pedestrians or vehicles move quickly into the detection range of the sensors.
- Pedestrians are obscured by other objects.
- In bends with a narrow radius.

### Setting Active Brake Assist

#### Requirements:

- The ignition is switched on.

Multimedia system:

 **Settings** **Assistance** **Active Brake Assist**

The following settings are available:

- **Early**
- **Medium**
- **Late**

 Select a setting.



The **Medium** setting is selected automatically every time the vehicle is started.

#### Deactivating Active Brake Assist

 It is recommended that Active Brake Assist is always left activated.

 Select **Off**.

The distance warning function and autonomous braking function are deactivated.

 When Active Brake Assist is deactivated, the  symbol appears in the status area of the multifunction display.

### Function of Adaptive Brake Lights

Adaptive Brake Lights warn following traffic in an emergency braking situation:

- By flashing the brake lamps
- By activating the hazard warning lights

If the vehicle is braked sharply from speeds above 50 km/h, the brake lamps flash rapidly.

This provides traffic travelling behind you with an even more noticeable warning.

If the vehicle is travelling at speeds of more than 70 km/h at the beginning of the brake application, the hazard warning lights switch on once the vehicle is stationary. When pulling away again, the hazard warning lights switch off automatically at approximately 10 km/h. You can also switch off the hazard warning lights using the hazard warning button.

### Cruise control and limiter

#### Function of cruise control

Cruise control accelerates and brakes the vehicle automatically in order to maintain a previously stored speed.

If you accelerate to overtake, for example, the stored speed is not deleted. If you remove your foot from the accelerator pedal after overtaking, cruise control will resume speed regulation back to the stored speed.

Cruise control is operated using the corresponding steering wheel buttons. You can store any road speed above 20 km/h.



If you fail to adapt your driving style, cruise control can neither reduce the risk of an accident nor override the laws of physics. It cannot take into account road, weather or traffic conditions. Cruise control is only an aid. You are responsible for the distance to the vehicle in front, for vehicle speed, braking in good time and for staying in your lane.

#### Displays in the multifunction display

The status of cruise control and the stored speed are shown in the multifunction display.



Instrument display (colour display)

-  Cruise control is selected
-  Set speed grey: speed is stored, cruise control is deactivated
-  Set speed green: speed is stored, cruise control is activated

## System limitations

Cruise control may be unable to maintain the stored speed on uphill gradients. The stored speed is resumed when the gradient evens out.

On long and steep downhill gradients, you should change down to a lower gear in good time. Take particular note of this when driving a laden vehicle. By doing so, you will make use of the engine's braking effect. This relieves the load on the brake system and prevents the brakes from overheating and wearing too quickly.

Do not use cruise control in the following situations:

- In traffic situations which require frequent changes of speed, e.g. in heavy traffic, on winding roads.
- On slippery roads. Accelerating can cause the drive wheels to lose traction and the vehicle could then skid.
- If you are driving when visibility is poor.

## Function of the limiter

**Vehicle with a permissible gross mass of up to 3.5 t:** the limiter limits the vehicle's speed. To reduce the speed swiftly to the set speed, the limiter applies the brakes automatically.

**Vehicle with a permissible gross mass of over 3.5 t:** the limiter limits the vehicle's speed.

You can limit the speed as follows:

- Variable: for speed limits, e.g. in built-up areas.
- Permanent: for long-term speed restrictions, e.g. when driving in winter tyre mode.

The variable limiter is operated using the corresponding steering-wheel buttons. You can store any road speed above 20 km/h. You can also perform settings while the vehicle is stationary if the vehicle has been started.

If you exceed the set speed with the variable limiter by over 3 km/h, the **LIM** symbol flashes in the instrument display. The **Limiter set speed exceeded** message appears. The flashing stops as soon as the speed drops below the set speed again.

If you fail to adapt your driving style, the limiter can neither reduce the risk of an accident nor override the laws of physics. It cannot take into account road, weather or traffic conditions. The limiter is only an aid. You are responsible for the distance to the vehicle in front, for vehicle speed, braking in good time and for staying in your lane.

## Displays in the multifunction display

The status of the limiter and the stored speed are shown in the multifunction display.

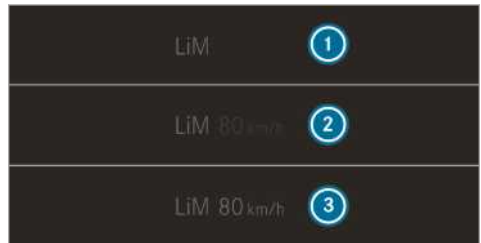

Instrument display (colour display)

- ① Limiter is selected
- ② Set speed grey: speed is stored, limiter is deactivated
- ③ Set speed green: speed is stored, limiter is activated

## Kickdown

If you depress the accelerator pedal beyond the pressure point (kickdown), the limiter switches to passive mode.

If you exceed the set speed with the variable limiter by over 3 km/h, the **LIM** symbol flashes in the instrument display. The **Limiter set speed exceeded** message appears.

After completion of kickdown, the variable limiter is activated again in the following situations:

- If the driven speed drops below the stored speed.
- If the stored speed is called up.
- If you store a new speed.

## Operating cruise control or the variable limiter

**⚠ WARNING** Risk of accident due to stored speed

If you call up the stored speed and this is lower than your current speed, the vehicle decelerates.

- ▶ Take into account the traffic situation before calling up the stored speed.

## Requirements:

Cruise control

- Cruise control is selected.
- ESP® is activated, but may not intervene.

- The driving speed is at least 20 km/h.

Variable limiter

- The vehicle has been started.
- The variable limiter is selected

**Switching between cruise control and the variable speed limiter**

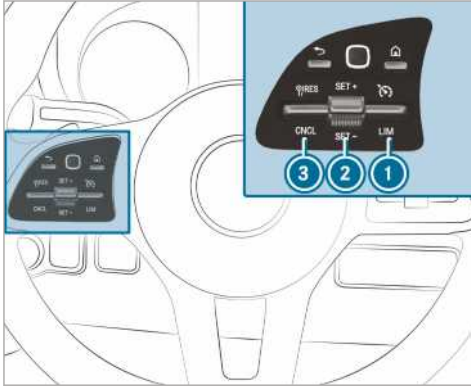

▶ **To select cruise control:** push rocker switch ① up.

▶ **To select the variable limiter:** push rocker switch ① down.

- ① Vehicles with Active Distance Assist DISTRONIC: the variable limiter is selected by a different button (→ page 154).

**Activating cruise control or the variable limiter**

- ▶ Push rocker switch ② up (SET+) or down (SET-).
- ▶ Remove your foot from the accelerator pedal. The current speed is stored and the vehicle maintains this speed (cruise control) or does not exceed it (variable speed limiter).

**Increasing/decreasing speed**

▶ Push rocker switch ② up/down. The stored speed is increased or reduced by 1 km/h.

or

▶ Press rocker switch ② up or down and hold. The stored speed is increased or reduced in 1 km/h increments.

or

▶ Push rocker switch ② beyond the pressure point. The stored speed is increased or reduced by 10 km/h.

or

▶ Push rocker switch ② beyond the pressure point and hold. The stored speed is increased or reduced in 10 km/h increments.

or

▶ Accelerate the vehicle to the desired speed.

▶ Push rocker switch ② up.

- ① **Vehicles with manual transmission:** if the engine speed is very low, cruise control or the limiter is deactivated. When the engine speed approaches maximum engine speed, the transmission is in neutral or the clutch pedal is depressed for longer than six seconds, cruise control is deactivated.

**Adopting the detected speed**

If cruise control/the variable limiter is activated and Traffic Sign Assist has detected a speed restriction sign, and this maximum permissible speed is displayed in the instrument display:

▶ Push rocker switch ③ up. The maximum permissible speed shown by the traffic sign is stored and the vehicle maintains or does not exceed this speed.

**Deactivating cruise control or the variable limiter**

▶ Press rocker switch ③ (CNCL) down.

When cruise control or the variable limiter is deactivated:

- rocker switch ② (SET+) or (SET-) stores the current speed and the vehicle maintains this speed.
- rocker switch ③ (RES) calls up the last speed stored and the vehicle maintains this speed.

- ① If you brake, deactivate ESP® or if ESP® intervenes, cruise control is deactivated. The variable limiter is not deactivated.

When you switch off the vehicle, the last speed stored is cleared.

**Permanent limiter**

If you wish to limit the vehicle speed permanently to a specific value (e.g. for driving in winter tyre mode), you can set this speed with the permanent limiter.



You do this by limiting the speed to a value between 120 km/h and 180 km/h in the multimedia system (→ page 153).

Shortly before the set speed is reached, it appears in the multifunction display. When you confirm the message with , display messages no longer appear until you switch off the vehicle. The speed will only be displayed again once the vehicle has been restarted.

The permanent limiter does not switch to passive mode even during kickdown and the driven speed remains below the set speed.

### Setting the speed limitation for winter tyres

Multimedia system:

  **» Settings** **» Fahrzeug (Vehicle)** **» Winter tyres limit**

 Select a speed or deactivate the function.

## Active Distance Assist DISTRONIC

### Function of Active Distance Assist DISTRONIC

Active Distance Assist DISTRONIC maintains the set speed on free-flowing roads. If vehicles ahead are detected, the set distance is maintained, if necessary until the vehicle comes to a halt. The vehicle accelerates or brakes depending on the distance to the vehicle in front and the set speed. Speed and distance are set and stored at the steering wheel. The speed can be set in the range between 20 km/h and 160 km/h or between 20 km/h and the vehicle's maximum speed.

Other features of Active Distance Assist DISTRONIC:

- Depending on the preselected distance, DISTRONIC intervenes either dynamically (short distance) or to save fuel (greater distance).
- Depending on the vehicle mass detected, the dynamics of the DISTRONIC intervention are reduced.
- Rapid acceleration to the stored speed is initiated if the turn signal indicator is switched on to change to the overtaking lane.

Active Distance Assist DISTRONIC is only an aid. The driver is responsible for the distance to the vehicle in front, for vehicle speed and for braking in good time.

### System limitations

The system may be impaired or may not function in the following instances:

- In snow, rain, fog, heavy spray, if there is glare, in direct sunlight or in greatly varying light conditions.
- In multi-storey car parks or on roads with steep uphill or downhill gradients.
- If the radar sensors are dirty or covered.
- On icy or slippery roads, braking or accelerating can cause the drive wheels to lose traction and the vehicle could then skid.
- Stationary objects are not detected if these were not previously detected as moving.
- On bends, target vehicles may be lost or not recognised correctly. As a result, a target vehicle is not used to regulate the speed which may lead to unwanted acceleration.

Do not use Active Distance Assist DISTRONIC in these situations.

#### **WARNING** Risk of accident from acceleration or braking by Active Distance Assist DISTRONIC

Active Distance Assist DISTRONIC may accelerate or brake in the following cases, for example:

- If the vehicle pulls away using Active Distance Assist DISTRONIC.
- If the stored speed is called up and is considerably faster or slower than the currently driven speed.
- If Active Distance Assist DISTRONIC no longer detects a vehicle in front or does not react to relevant objects.

 Always carefully observe the traffic conditions and be ready to brake at all times.

 Take into account the traffic situation before calling up the stored speed.

#### **WARNING** Risk of accident due to insufficient deceleration by Active Distance Assist DISTRONIC

Active Distance Assist DISTRONIC brakes your vehicle with up to 50 % of the maximum possible deceleration. If this deceleration is not sufficient, Active Distance Assist

DISTRONIC alerts you with a visual and acoustic warning.

- ▶ In these cases, adjust your speed and keep a sufficient distance.
- ▶ Brake the vehicle yourself and/or take evasive action.

**⚠ WARNING** Risk of accident if detection function of Active Distance Assist DISTRONIC is impaired

Active Distance Assist DISTRONIC does not react or only partially reacts:

- when driving on a different line to the vehicle ahead or when changing lanes
- to pedestrians, animals, bicycles or stationary vehicles, or unexpected obstacles
- to traffic and the surroundings
- to oncoming vehicles and crossing traffic

Active Distance Assist DISTRONIC can neither give warnings nor intervene in such situations.

- ▶ Always observe the traffic conditions carefully and react accordingly.

### Operating Active Distance Assist DISTRONIC

#### Requirements:

- The vehicle has been started.
- The parking brake has been released.
- ESP® is activated and is not intervening.
- The transmission is in position **D**.
- The driver's and the co-driver door are closed.
- The seat occupancy recognition on the driver's seat has detected that the driver has fastened the seat belt.
- The check of the radar sensor system has been successfully completed.

### Switching between the speed limiter and Active Distance Assist DISTRONIC

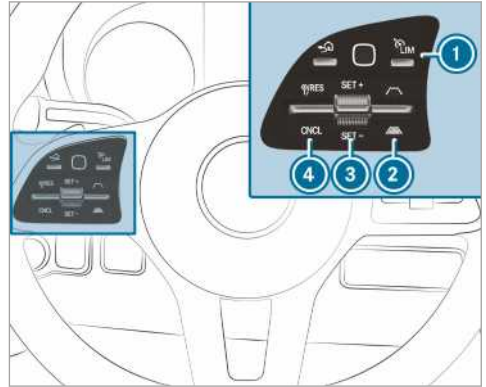

- ▶ Press button **1**.

#### Activating Active Distance Assist DISTRONIC or the variable speed limiter

- ▶ **To activate without a stored speed:** press rocker switch **3** up (SET+) or down (SET-). The current speed is stored and maintained by the vehicle (Active Distance Assist DISTRONIC) or limited (variable speed limiter).

or

- ▶ **To activate with a stored speed:** press rocker switch **4** (RES) up.

- i** If rocker switch **4** is pressed up twice, Active Distance Assist DISTRONIC or the variable speed limiter is activated with the speed restriction displayed in the instrument cluster.

#### Adopting the displayed speed limit when Distance Assist DISTRONIC or limiter is activated

- ▶ Push rocker switch **4** (RES) up. The speed limit displayed in the instrument cluster is adopted as the stored speed. The vehicle adapts its speed to that of the vehicle in front, but only up to the stored speed.

#### Pulling away again with Active Distance Assist DISTRONIC

- ▶ Remove your foot from the brake pedal.
- ▶ Push rocker switch **4** (RES) up.

or

- ▶ Depress the accelerator pedal briefly and distinctly.  
The functions of Active Distance Assist DISTRONIC continue to be carried out.

### Deactivating Active Distance Assist DISTRONIC

**⚠ WARNING** Risk of accident due to Active Distance Assist DISTRONIC still being activated when you leave the driver's seat

If you leave the driver's seat while the vehicle is being braked by Active Distance Assist DISTRONIC only, the vehicle can roll away.

- ▶ Always deactivate Active Distance Assist DISTRONIC and secure the vehicle to prevent it from rolling away before you leave the driver's seat.

- ▶ Press rocker switch ④ (CNCL) down.
- ▶ Depress the brake pedal.

### Increasing or reducing the speed

- ▶ Push rocker switch ③ up (SET+) or down (SET-).  
The stored speed is increased or reduced by 1 km/h.

or

- ▶ Push rocker switch ③ up (SET+) or down (SET-) and hold.  
The stored speed is increased or reduced in 1 km/h increments.

or

- ▶ Push rocker switch ③ beyond the pressure point.  
The stored speed is increased or reduced by 10 km/h.

or

- ▶ Push rocker switch ③ beyond the pressure point and hold.  
The stored speed is increased or reduced in 10 km/h increments.

### Increasing or reducing the specified distance from the vehicle in front

- ▶ **To increase the specified distance:** press

rocker switch ② down (.

- ▶ **To reduce the specified distance:** press

rocker switch ② up (.

### Information on Hill Start Assist

Hill Start Assist holds the vehicle for a short time when pulling away on a hill under the following conditions:

- Vehicles with manual transmission: a gear is engaged.
- Vehicles with automatic transmission: the transmission is in position **D** or **R**.
- The parking brake has been released

This gives you enough time to move your foot from the brake pedal to the accelerator pedal and depress it before the vehicle begins to roll.

**⚠ WARNING** Risk of accident and injury caused by the vehicle rolling away

After a short time, Hill Start Assist no longer holds the vehicle and it can roll away.

- ▶ Therefore, swiftly move your foot from the brake pedal to the accelerator pedal. Never attempt to leave the vehicle if it is being held by Hill Start Assist.

### HOLD function

#### HOLD function

Requirements:

- The seat occupancy recognition on the driver's seat has detected that the driver has fastened the seat belt.

The HOLD function holds the vehicle at a standstill without requiring you to depress the brake pedal, e.g. when pulling away on steep slopes. When you depress the accelerator pedal to pull away, the braking effect is cancelled and the HOLD function is deactivated.

#### System limitations

- The incline must not be greater than 30%.

### Parking Assist PARKTRONIC

#### Function of Parking Assist PARKTRONIC

Parking Assist PARKTRONIC is an electronic parking assistance system with ultrasound. It monitors the area around your vehicle using six sen-



sors in the front bumper and six sensors in the rear bumper. Parking Assist PARKTRONIC indicates visually and audibly the distance between your vehicle and an object.

Parking Assist PARKTRONIC is only an aid. It is not a substitute for your attention to the surroundings. You are always responsible for safe manoeuvring, parking and exiting of a parking space. Make sure that there are no persons, animals or objects etc., in the manoeuvring area while manoeuvring and parking or exiting parking spaces.

In the standard setting, an intermittent warning tone sounds from a distance of approximately 0.4 m to an obstacle. A continuous tone sounds from a distance of approximately 0.3 m. You can set the warning tone in the multimedia system so that it will sound earlier at a greater distance of approximately 1 m (→ page 156).

### Parking Assist PARKTRONIC display in the multimedia system

If the Parking Assist PARKTRONIC display is not active in the multimedia system and an obstacle is detected in the path of the vehicle, a pop-up window for Parking Assist PARKTRONIC appears in the multimedia system at speeds of up to approximately 10 km/h.

### System limitations

Parking Assist PARKTRONIC does not necessarily take into account the following obstacles:

- obstacles below the detection range, e.g. persons, animals or objects
- obstacles above the detection range, e.g. overhanging loads, tail sections or loading ramps of lorries

The sensors must be free of dirt, ice and slush. Otherwise, they may not function correctly. Clean the sensors regularly, taking care not to scratch or damage them.

**Vehicles with trailer hitch:** Parking Assist PARKTRONIC is deactivated for the rear zone when you establish an electrical connection between your vehicle and a trailer.

### Deactivating/activating Parking Assist PARKTRONIC

**I NOTE** Risk of an accident from objects at close range

Parking Assist PARKTRONIC may not detect certain objects at close range.

▶ When parking or manoeuvring the vehicle, pay particular attention to any objects which are above or below the sensors, e.g. flowerpots or drawbars. The vehicle or other objects could otherwise be damaged.

Multimedia system:

→  ▶ Settings ▶ Quick access

#### ▶ Select **PARKTRONIC On**.

The function is activated or deactivated depending on the previous setting.

 Parking Assist PARKTRONIC is automatically activated when starting the vehicle.

### Setting the warning tones of Parking Assist PARKTRONIC

Multimedia system:

→  Settings ▶ Assistance ▶ Camera & Park. Assist ▶ Set warning tone

### Adjusting the volume of the warning tones

- ▶ Select **Warning tone volume**.
- ▶ Adjust the value.

### Adjusting the pitch of the warning tones

- ▶ Select **Warning tone pitch**.
- ▶ Adjust the value.

### Specifying the starting point for the warning tones

You can specify whether the Parking Assist PARKTRONIC warning tones should commence when the vehicle is further away from an obstacle.

- ▶ Select **Warn early all-round**.
- ▶ Activate or deactivate the function.

### Activating or deactivating audio fadeout

You can specify whether the volume of a media source in the multimedia system is to be reduced when Parking Assist PARKTRONIC gives a warning tone.

- ▶ Select **Audio fadeout during warning tones**.
- ▶ Activate or deactivate the function.

## Reversing camera

### Function of the reversing camera

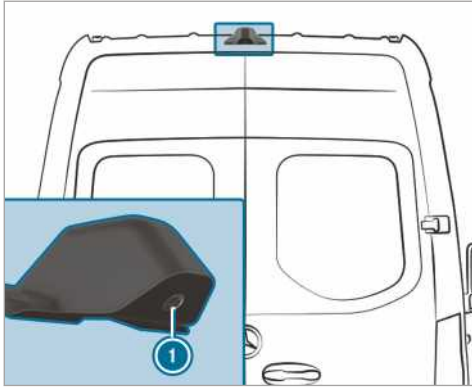

If you have activated the function in the multimedia system, the image from reversing camera ① is displayed in the multimedia system when reverse gear is selected. Dynamic guide lines show the path the vehicle will take with the steering wheel in its current position. This helps you to orientate yourself and to avoid obstacles when reversing.

If the following conditions have been met, the image from reversing camera ① is also displayed in the multimedia system:

- the ignition is switched on
- reverse gear has not been engaged
- the rear doors are opened

In this way, the area behind the vehicle may be monitored.

When the rear doors are closed, the image from the reversing camera is switched off for approximately ten seconds.

The reversing camera is only an aid. It is not a substitute for you paying attention to the surroundings. You are always responsible for safe manoeuvring and parking. Make sure that there are no persons, animals or objects etc. in the manoeuvring area while manoeuvring and parking in parking spaces.

The reversing camera may show a distorted view of obstacles, show them incorrectly or not at all. The reversing camera cannot show all objects which are very near to or under the rear bumper. It will not warn you of a collision, people or objects.

You can select from the following views:

- normal view
- wide-angle view
- trailer view

The area behind the vehicle is displayed as a mirror image, as in the inside rearview mirror.

### System limitations

The reversing camera will not function or will only partially function in the following situations:

- if there is heavy rain, snow or fog
- if the light conditions are poor, e.g. at night
- if the area is illuminated with fluorescent lighting (the display may flicker)
- if the temperature changes very quickly, for example if you drive into a heated garage in the winter
- if the ambient temperature is very high
- if the camera lens is covered, dirty or misted up. Observe the notes on cleaning the reversing camera (→ page 279).
- the camera or rear of your vehicle is damaged. In this case, have the camera and its position and setting checked at a qualified specialist workshop.

The field of vision and other functions of the reversing camera may be restricted due to additional accessories on the rear of the vehicle (e.g. loading tailgate).

- ① The display contrast may be impaired due to incidental sunlight or other light sources. In this case, pay particular attention.
- ① Have the display repaired or replaced if, for example, pixel errors considerably restrict its use.
- ① Objects that are not at ground level appear further away than they actually are, for example:
  - the bumper of a vehicle parked behind
  - the drawbar of a trailer
  - the ball neck of a trailer coupling
  - the tail-end of a lorry
  - slanted posts

Only use the guide lines of the camera image for orientation. Do not travel further than the lowest horizontal guide line when approaching objects. You may otherwise damage your vehicle and/or the object.

**Vehicles without Park Assist PARKTRONIC**

The following camera views are available in the multimedia system:

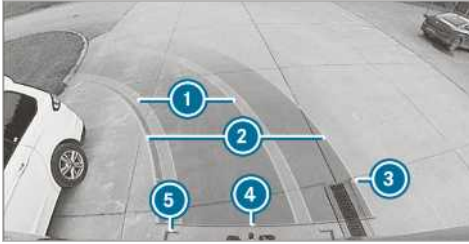

Normal view

- ① Yellow lane marking the course the tyres will take at the current steering wheel angle (dynamic)
- ② Yellow guide line, vehicle width (driven surface) depending on the current steering wheel angle (dynamic)
- ③ Marking at a distance of approximately 1.0 m (the rear doors can still be opened completely.)
- ④ Red guide line at a distance of approximately 0.3 m from the rear area
- ⑤ Red guide lines at a distance of approximately 0.2 m from the rear area, vehicle width including exterior mirrors



Wide-angle view

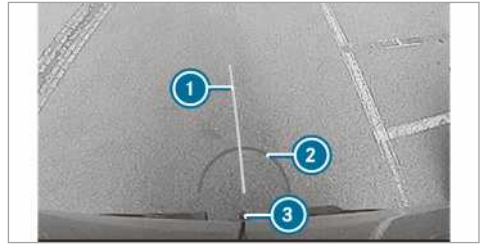

View of trailer (if trailer hitch is fitted)

- ① Yellow guide line, locating aid
- ② Red guide line at a distance of approximately 0.3 m to the ball head of the trailer hitch
- ③ Ball head of the trailer hitch

**Vehicles with Park Assist PARKTRONIC**

The following camera views are available in the multimedia system:

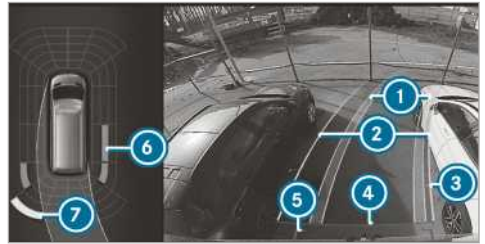

Normal view

- ① Yellow lane marking the course the tyres will take at the current steering wheel angle (dynamic)
- ② Yellow guide line, vehicle width (driven surface) depending on the current steering wheel angle (dynamic)
- ③ Marking at a distance of approximately 1.0 m (the rear doors can still be opened completely.)
- ④ Red guide line at a distance of approximately 0.3 m from the rear area
- ⑤ Red guide lines at a distance of approximately 0.2 m from the rear area, vehicle width including exterior mirrors
- ⑥ Orange warning display of Parking Assist PARKTRONIC: obstacles are a medium distance away (between approximately 0.4 m and 0.6 m)
- ⑦ Yellow warning display of Parking Assist PARKTRONIC: obstacles are at a distance of between approximately 0.6 m and 1.0 m

- ❗ If the distance to the obstacle is less than approx. 0.4 m, the warning display of Parking Assist PARKTRONIC will be red.
- ❗ If the entire system fails, the inner segments of the warning display are shown in red.

If the system fails at the rear, the segment display changes in the following ways:

- The rear segments are shown in red when reversing.
- The rear segments are hidden when driving forwards.

If Parking Assist PARKTRONIC is deactivated, the warning display fades out.



Wide-angle view

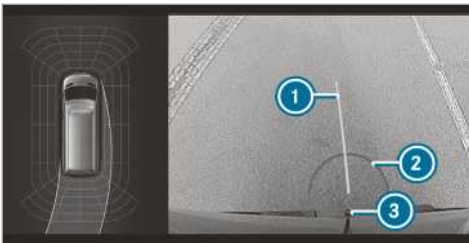

View of trailer (if trailer hitch is fitted)

- ❶ Yellow guide line, locating aid
- ❷ Red guide line at a distance of approximately 0.3 m to the ball head of the trailer hitch
- ❸ Ball head of the trailer hitch

## 360° Camera

### Function of the 360° Camera

The 360° Camera is a system that consists of four cameras. The cameras cover the immediate vehicle surroundings. The system assists you, e.g. when parking or at exits with reduced visibility.

The 360° Camera is only an aid. It is not a substitute for you paying attention to the surroundings.

You are always responsible for safe manoeuvring and parking. Make sure that there are no persons, animals or objects etc. in the manoeuvring area while manoeuvring and parking in parking spaces.

The system evaluates images from the following cameras:

- reversing camera
- front camera
- two side cameras in the outside mirrors

### Views of the 360° Camera

You can select from different views:

#### Top view

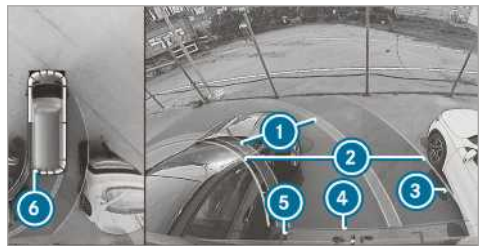

- ❶ Yellow lane marking the course the tyres will take at the current steering wheel angle (dynamic)
- ❷ Yellow guide line, vehicle width (driven surface) depending on the current steering wheel angle (dynamic)
- ❸ Marking at a distance of approximately 1.0 m (the rear doors can still be opened completely.)
- ❹ Red guide line at a distance of approximately 0.3 m from the rear area
- ❺ Red guide lines at a distance of approximately 0.2 m from the rear area, vehicle width including exterior mirrors
- ❻ Red warning display of Parking Assist PARKTRONIC: obstacles at a distance of approximately 0.4 m or less

When Parking Assist PARKTRONIC is operational and no object is detected, the segments of the warning display are shown in grey.

- ❗ If the entire system fails, the segments of the warning display are shown in red.

If the system fails at the rear, the segment display changes in the following ways:

- the rear segments are shown in red when reversing

- the rear segments are hidden when driving forwards

If Parking Assist PARKTRONIC is deactivated, the warning display fades out.

### Guide lines

- i** The guide lines in the multimedia system display show the distances to your vehicle. The distances only apply to road level. In trailer mode, the guide lines are shown at the level of the trailer hitch.

### Trailer view (if trailer hitch is fitted)



View of trailer (if trailer hitch is fitted)

- 1 Yellow guide line, locating aid
- 2 Red guide line at a distance of approximately 0.3 m to the ball head of the trailer hitch
- 3 Ball head of the trailer hitch

### Side view of the mirror cameras

The sides of the vehicle can be seen in this view.

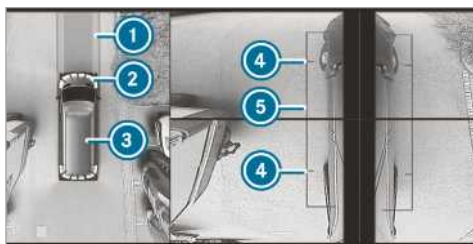

- 1 Lane indicating the route the vehicle will take with the steering wheel in its current position
- 2 Yellow warning display of Parking Assist PARKTRONIC: obstacles at a distance of approximately 1.0 m or less
- 3 Your vehicle from above
- 4 Marker of the wheel contact points
- 5 Guide line of external vehicle dimensions with outside mirrors folded out

If the distance to the object lessens, the colour of the warning display **2** changes.

### System failure

If there is no operational readiness, the following display appears in the multimedia system:



### System limitations

The 360° Camera will not function or will only partially function in the following situations:

- if the front doors are open
- if the side mirrors are folded in
- if there is heavy rain, snow or fog
- if the light conditions are poor, e.g. at night
- if the area is illuminated with fluorescent lighting (the display may flicker)
- if the temperature changes very quickly, for example if you drive into a heated garage in the winter
- if the ambient temperature is very high
- if the camera lens is covered, dirty or misted up
- if cameras, or vehicle components in which the cameras are fitted, are damaged. In this event, have the cameras, their positions and their setting checked at a qualified specialist workshop.

Do not use the 360° Camera under such circumstances. You could otherwise injure others or collide with objects when parking the vehicle.

On vehicles with height-adjustable suspension, or if the vehicle is carrying a heavy load, leaving the standard height can result in inaccuracies in the guide lines and in the display of the generated images, depending on technical conditions.

The field of vision and other functions of the camera system may be restricted due to additional accessories on the rear of the vehicle (e.g. loading tailgate).

- ❗ The display contrast may be impaired by sudden, incidental sunlight or other light sources, e.g. when you are driving out of a garage. In this case, pay particular attention.
- ❗ Have the display repaired or replaced if, for example, pixel errors considerably restrict its use.

If the following conditions have been met, the image from the 360° camera will automatically be displayed in the multimedia system:

- the ignition is switched on
- the rear doors are opened

The area behind the vehicle can therefore be monitored.

When the rear doors are closed, the image from the reversing camera is switched off for approximately ten seconds.

See the notes on cleaning the 360° Camera (→ page 279).

### Selecting a view for the 360° Camera

#### Requirements:

- The [Auto reversing camera](#) is activated in the multimedia system (→ page 161).

- ▶ Engage reverse gear.
- ▶ Select the desired view in the multimedia system.

### Activating/deactivating automatic operation of the reversing camera

The reversing camera is only an aid. It is not a substitute for you paying attention to the surroundings. You are always responsible for safe manoeuvring, parking and exiting of a parking space. Make sure that no persons, animals or objects etc. are in the path of your vehicle. Pay attention to your surroundings and be ready to brake at all times.

Multimedia system:

→  ▶ Settings ▶ Fahrzeug (Vehicle) ▶ Rear view camera

- ▶ Activate or deactivate [Auto reversing camera](#).

### Activating/deactivating manoeuvring assistance

Multimedia system:

→  ▶ Settings ▶ Assistance ▶ Camera & Park. Assist

- ▶ Activate or deactivate [Manoeuvring assist.](#)

- ❗ When manoeuvring assistance is activated, the following functions are active:
  - Drive Away Assist (→ page 165)
  - Rear Cross Traffic Alert (→ page 165)

## ATTENTION ASSIST

### Function of ATTENTION ASSIST

ATTENTION ASSIST assists you on long, monotonous journeys, e.g. on motorways and trunk roads. If ATTENTION ASSIST detects indicators of fatigue or increased lapses in concentration on the part of the driver, it suggests taking a break.

ATTENTION ASSIST is only an aid. It cannot always detect drowsiness or increased lapses in concentration in good time. The system is not a substitute for a well-rested and attentive driver. On long journeys, take regular and timely breaks that allow you to rest properly.

You can choose between two settings:

- **Standard:** normal system sensitivity
- **Sensitive:** higher system sensitivity. The driver is warned earlier and the attention level detected by the system (Attention Level) is adapted accordingly.

If fatigue or increased lapses in concentration are detected, the [Attention Assist: Pause!](#) warning appears in the Instrument Display. You can acknowledge the message and take a break if necessary. If you do not take a break and ATTENTION ASSIST continues to detect increased lapses in concentration, you will be warned again after a minimum of 15 minutes.

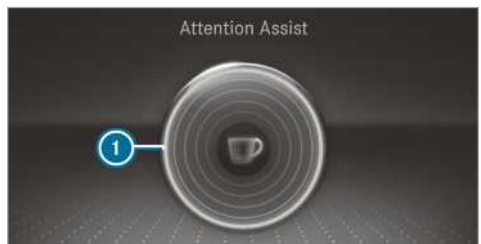

Display in the Instrument Display (colour display)

You can have the following status information for ATTENTION ASSIST displayed in the Assistance menu of the on-board computer:

- the journey length since the last break
- the attention level determined by ATTENTION ASSIST:



- the fuller the circle is, the higher the detected attention level is
- the circle in the centre of the display empties from the outside inwards as attentiveness decreases

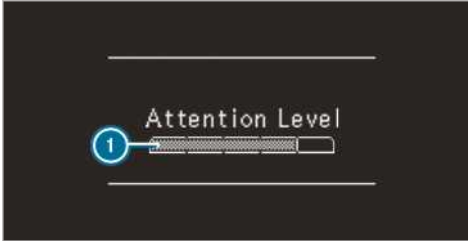

Display in the Instrument Display (black and white display)

You can have the following status information for ATTENTION ASSIST displayed in the Assistance menu of the on-board computer:

- the journey length since the last break
- the attention level determined by ATTENTION ASSIST:
  - the fuller the bar is, the higher the detected attention level is
  - the bar empties as attentiveness decreases

If ATTENTION ASSIST cannot calculate the attention level and cannot issue a warning, the **Attention level** message appears.

If a warning is displayed in the Instrument Display, the multimedia system offers to search for a rest area. You can select a rest area and start navigation to this rest area. This function can be activated and deactivated in the multimedia system.

If ATTENTION ASSIST is deactivated, the  symbol appears in the assistance graphic in the Instrument Display when the engine is running. ATTENTION ASSIST is activated automatically when the engine is re-started. The last selected sensitivity level remains stored.

### System limitations

ATTENTION ASSIST is active in the 60 km/h to 200 km/h speed range.

The functionality of ATTENTION ASSIST is restricted, and warnings may be delayed or not occur at all, in the following situations:

- on journeys lasting less than approximately 30 minutes
- if the road condition is poor (uneven road surface or potholes)
- in strong crosswinds
- if you adopt a sporty driving style (high cornering speeds or high rates of acceleration)
- if the time is set incorrectly
- if you change lanes and vary your speed frequently in active driving situations

The ATTENTION ASSIST drowsiness or alertness assessment is deleted and restarted when continuing the journey in the following situations:

- if you switch off the engine
- if you unfasten your seat belt and open the driver's door (e.g. change drivers or take a break)

### Setting ATTENTION ASSIST



Multimedia system:

  **» Settings » Assistance » Attention Assist**

### Setting options

 Select **Standard**, **Sensitive** or **Off**.

### Suggesting a rest area

-  Select **Suggest rest area**.
-  Activate or deactivate the function. If ATTENTION ASSIST detects fatigue or an increasing lack of attention, it suggests a nearby rest area.
-  Select a suggested rest area. You are guided to the selected rest area.

## Traffic Sign Assist

### Function of Traffic Sign Assist



Traffic Sign Assist detects traffic signs with multi-function camera ①. It assists you by displaying detected speed limits and overtaking restrictions in the instrument cluster.

Since Traffic Sign Assist also uses the data stored in the navigation system, it can also update the display without detecting traffic signs:

- when the vehicle changes roads, e.g. motorway exit or slip road
- when a village or town boundary stored in the digital map is passed

If the system detects that you are driving onto a section of road in the wrong direction of travel, it triggers a warning.

The camera also detects traffic signs with a restriction indicated by an additional sign (e.g. in wet conditions).

### Warning when the maximum permissible speed is exceeded

The system can warn you if you unintentionally exceed the maximum permissible speed. To do this, you can specify in the multimedia system by how much the maximum permissible speed can be exceeded before a warning is issued. You can specify whether the warning is to be just a visual warning or an audible one as well.

### Display in the Instrument Display

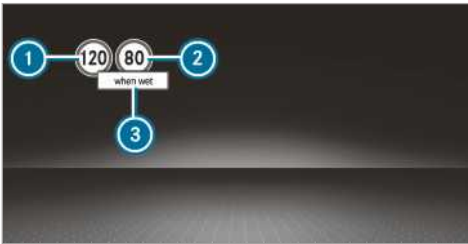

Instrument Display (colour display)

- ① Permissible speed
  - ② Permissible speed when there is a restriction
  - ③ Additional sign with a restriction
- ⓘ Only one of traffic signs ① or ② is displayed at any one time in the instrument display, if necessary with additional sign ③. If two valid traffic signs are detected at the same time, a plus sign appears next to the traffic sign in the instrument display as an indication that both traffic signs are displayed in the navigation system.

Since Traffic Sign Assist also uses the data stored in the navigation system, it can also update the display without detecting traffic signs:

- when the vehicle changes roads, e.g. motorway exit or slip road
- when a village or town boundary stored in the digital map is passed

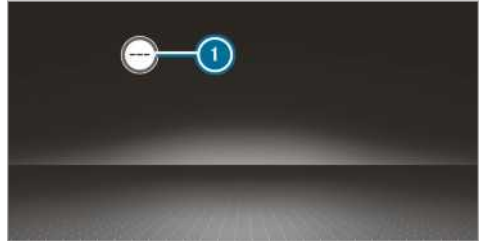

Traffic Sign Assist is not available in all countries. If it is unavailable, display ① is shown in the speedometer.

### System limitations

The system may be impaired or may not function in the following situations:

- if there is poor visibility, e.g. due to insufficient illumination of the road, if there are highly variable shade conditions or in rain, snow, fog or heavy spray
- if there is glare, e.g. from oncoming traffic, direct sunlight or reflections
- if the windscreen in the area of the multifunction camera is dirty, or if the camera is misted up, damaged or covered
- if the traffic signs are hard to detect, e.g. due to dirt, because they are covered, due to snow or insufficient lighting
- if the information in the navigation system's digital map is incorrect or out-of-date
- if the signs are ambiguous, e.g. traffic signs on construction sites or in adjacent lanes

### Setting Traffic Sign Assist

Multimedia system:

→ Home ▶ Settings ▶ Assistance ▶ Traffic Sign Assist

### Displaying detected traffic signs in the media display

- ▶ Select [Display in head unit](#).
- ▶ Activate or deactivate the function.



### Setting the type of warning

- ▶ Select **Visual & audible**, **Visual** or **None**.

### Setting the warning threshold

This value determines at which point the warning is given once a speed limit is exceeded.

- ▶ Select **Warning threshold**.
- ▶ Set a speed.

## Blind Spot Assist

### Function of Blind Spot Assist with exit warning

Blind Spot Assist uses two lateral, rear-facing radar sensors to monitor the area directly next to and on the side behind the vehicle.

#### **▲ WARNING** Risk of accident despite Blind Spot Assist

Blind Spot Assist reacts neither to stationary objects nor to vehicles approaching and overtaking you at a greatly different speed.

As a result, Blind Spot Assist cannot warn drivers in these situations.

- ▶ Always pay careful attention to the traffic situation and maintain a safe distance at the side of the vehicle.

Blind Spot Assist is only an aid. It may fail to detect some vehicles and is no substitute for attentive driving. Always ensure that there is sufficient distance to the side for other road users and obstacles.

If a vehicle is detected above speeds of approximately 12 km/h and this vehicle subsequently enters the monitoring range directly next to your vehicle, the warning lamp in the outside mirror lights up red.

- ① When a trailer is connected, the radar sensor's field of vision may be impaired, thereby making limited monitoring possible. Always pay careful attention to the traffic situation and maintain a safe distance at the side of the vehicle.

If a vehicle is detected close to your vehicle in the lateral monitoring range and you switch on the turn signal indicator in the corresponding direction, a warning tone sounds. The red warning lamp in the outside mirror flashes. If the turn signal indicator remains switched on, all other detected vehicles are indicated only by the flashing of the red warning lamp.

If you overtake a vehicle quickly, no warning is given.

### Exit warning

The exit warning is an additional function of Blind Spot Assist and warns vehicle occupants when leaving the vehicle about any approaching vehicles.

#### **▲ WARNING** Risk of accident despite exit warning

The exit warning reacts neither to stationary objects nor to vehicles approaching you at a greatly different speed.

As a result, the exit warning cannot warn drivers in these situations.

- ▶ Always pay particular attention to the traffic situation when opening the doors and make sure there is sufficient clearance.

- ① An exit warning is not issued for sliding doors and rear-end doors.

### Overview

When the vehicle is stationary, an object is detected from behind in the monitoring range.	Display in outside mirror
When the vehicle is stationary, a door on the relevant side of the vehicle is opened. An object which is close to your vehicle is detected in the monitoring range.	Visual and audible warning

- ① This additional function is only available when Blind Spot Assist is activated and up to a maximum of three minutes after the ignition has been switched off. The end of the availability of the exit warning function is indicated by a series of flashes in the outside mirror.

The exit warning function is only an aid and is no substitute for the attentiveness of the vehicle occupants. Responsibility always lies with the vehicle occupants when opening doors and leaving the vehicle.

## System limitations

Blind Spot Assist and the exit warning function may be limited in the following situations:

- if there is dirt on the sensors or the sensors are obscured.
  - when there is poor visibility, e.g. due to fog, heavy rain, snow or spray.
  - if narrow vehicles are within the monitoring range, e.g. bicycles.
- ⓘ Standing or slowly moving objects are not displayed.

Warnings may be issued in error when driving close to crash barriers or similar solid lane borders. Warnings may be interrupted when driving alongside long vehicles, for example lorries, for a prolonged time.

Blind Spot Assist is not operational when reverse gear is engaged.

The exit warning function may be limited in the following situations:

- when the sensor is blocked by adjacent vehicles in narrow parking spaces
- when people are approaching

## Activating/deactivating Blind Spot Assist

Multimedia system:

➔  ➔ Settings ➔ Assistance

▶ Activate or deactivate **Blind Spot Assist**.

## Function of Drive Away Assist

ⓘ Drive Away Assist is only available for vehicles with automatic transmission.

Drive Away Assist can reduce the severity of an impact when pulling away. If an obstacle is detected in the direction of travel, the vehicle's speed is briefly reduced to approximately 2 km/h. If a critical situation is detected, a symbol appears on the camera image of the multimedia system.

**⚠ WARNING** Risk of accident caused by limited detection performance of Drive Away Assist

Drive Away Assist cannot always clearly identify objects and traffic situations.

In such cases, Drive Away Assist might:

- Warn you without reason and limit the vehicle speed.

- Not warn you or not limit the vehicle speed.

- ▶ Always pay careful attention to the traffic situation; do not rely on Drive Away Assist alone.
- ▶ Be prepared to brake or swerve as necessary, provided the traffic situation permits and that it is safe to take evasive action.

Drive Away Assist is only an aid. It is not a substitute for your attention to the surroundings. You are always responsible for safe manoeuvring, parking and exiting of a parking space. Make sure that no persons, animals or objects etc. are in the path of your vehicle.

A risk of a collision may arise in the following situations, for example:

- If the driver mixes up the accelerator and brake pedals.
- If the wrong gear is selected.

The Drive Away Assist function is active under the following conditions:

- If Parking Assist PARKTRONIC is activated.
- Every time the gear is changed to **R** or **D** when the vehicle is at a standstill.
- If the detected obstacle is less than approximately 1.0 m away.
- If the manoeuvring assistance function is activated in the multimedia system.

## System limitations

Drive Away Assist is unavailable on inclines and when driving with a trailer.

## Function of Rear Cross Traffic Alert

The radar sensors in the bumper are used for the system. This way the area adjacent to the vehicle is continually monitored. If the radar sensors are obscured by vehicles or other objects, detection is not possible.

ⓘ Also read the notes on Blind Spot Assist (→ page 164).

**Vehicles with Blind Spot Assist:** drivers can also be warned of any crossing traffic when reversing out of a parking space. If a vehicle is detected, the warning lamp in the outside mirror on the relevant side lights up red. If it detects a critical situation, a warning tone also sounds.

**Vehicles with Blind Spot Assist and Parking Assist PARKTRONIC:** drivers can also be warned of any crossing traffic when reversing out of a parking space. If a critical situation is detected, a warning symbol appears on the camera image of the multimedia system. If the driver does not respond to the warning, the vehicle's brakes can be applied automatically. In this case, a warning tone sounds.

The Rear Cross Traffic Alert function is active under the following conditions:

- Blind Spot Assist is activated
- reverse gear is engaged or the vehicle is reversing at walking pace
- If the manoeuvring assistance function is activated in the multimedia system.

The Rear Cross Traffic Alert function is unavailable when driving with a trailer.

## Lane Keeping Assist and Active Lane Keeping Assist

### Functions of Lane Keeping Assist

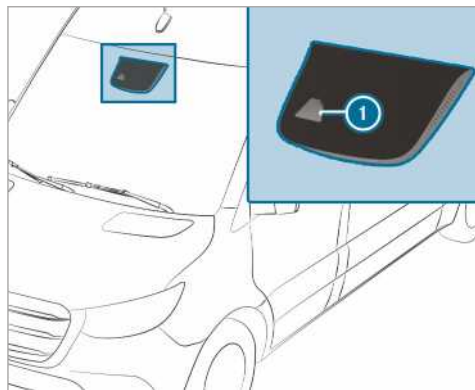

Lane Keeping Assist monitors the area in front of your vehicle with multifunction camera ①. It serves to protect you against unintentionally leaving your lane. You may also be warned by a vibrating message from the steering wheel and by the status symbol flashing in the instrument display.

The warning is issued when the following conditions are met at the same time:

- Lane Keeping Assist detects lane markings.
- A front wheel passes over the lane markings.

You can activate and deactivate the Lane Keeping Assist warning.

If you fail to adapt your driving style, Lane Keeping Assist can neither reduce the risk of accident nor override the laws of physics. It cannot take into account road, weather or traffic conditions. Lane Keeping Assist is only an aid and is not intended to keep the vehicle in the lane without the driver's cooperation. You are responsible for the distance to the vehicle in front, for vehicle speed, braking in good time and for staying in your lane.

### System limitations

The system may be impaired or may not function in the following situations:

- There is poor visibility, e.g. due to insufficient illumination of the road, highly variable shade conditions, or due to rain, snow, fog or heavy spray.
- Dazzle from oncoming traffic, direct sunlight or reflections.
- There is dirt on the windscreen in the vicinity of the multifunction camera or the camera is misted up, damaged or obscured.
- No or several, unclear lane markings are present for one lane, e.g. in a construction area.
- The lane markings are worn, dark or covered.
- The distance to the vehicle in front is too small and the lane markings are thus not detected.
- The lane markings change quickly, e.g. lanes branch off, cross one another or merge.
- The carriageway is very narrow and winding.

### Functions of Active Lane Keeping Assist

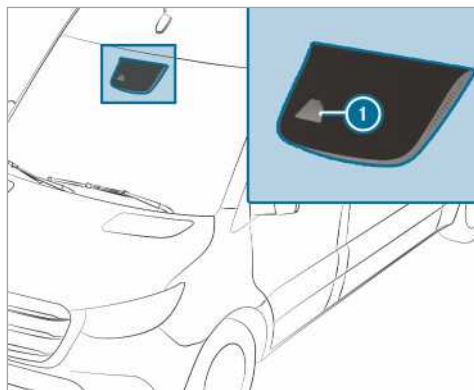

Active Lane Keeping Assist monitors the area in front of your vehicle by means of multifunction camera ①. It serves to protect you against unintentionally leaving your lane. You may also be warned by a vibrating message from the steering wheel and by the status symbol flashing in the instrument display. In addition, you may be guided back into your lane by a lane-correcting brake application. A relevant message appears in the instrument display.

The warning is issued when the following conditions are met at the same time:

- The driving system detects lane markings.
- A front wheel passes over the lane markings.

A lane-correcting brake application occurs when the following conditions are met:

- Active Lane Keeping Assist detects lane markings on both sides of the vehicle.
- A front wheel drives over a solid lane marking.

A relevant message appears in the instrument display.

The brake application is available in the speed range between 60 km/h and 160 km/h.

You can either deactivate the Active Lane Keeping Assist warning or switch off the system completely.

If you fail to adapt your driving style, Active Lane Keeping Assist can neither reduce the risk of an accident nor override the laws of physics. It cannot take into account road, weather or traffic conditions. The driving system is an aid for when you unintentionally leave or cross the lane and not a system for automatically keeping to the lane. You are responsible for the distance to the vehicle in front, for vehicle speed, braking in good time and for staying in your lane.



Example image

If a lane-correcting brake application from Active Lane Keeping Assist occurs, display ① appears in the multifunction display.

### System limitations

No lane-correcting brake application from Active Lane Keeping Assist occurs in the following situations:

- You clearly and actively steer, brake or accelerate.
- You switch on the turn signal.
- A driving safety system intervenes, such as ESP® or Active Brake Assist.
- You have adopted a sporty driving style with high cornering speeds or high rates of acceleration.
- ESP® is deactivated.
- When driving with a trailer, the electrical connection to the trailer has been correctly established.
- If a loss of tyre pressure or a defective tyre has been detected and displayed.

The system may be impaired or may not function in the following situations:

- There is poor visibility, e.g. due to insufficient illumination of the road, highly variable shade conditions, or due to rain, snow, fog or heavy spray.
- Dazzle from oncoming traffic, direct sunlight or reflections.
- There is dirt on the windscreen in the vicinity of the multifunction camera or the camera is misted up, damaged or obscured.
- No or several, unclear lane markings are present for one lane, e.g. in a construction area.
- The lane markings are worn, dark or covered.
- The distance to the vehicle in front is too small and the lane markings are thus not detected.
- The lane markings change quickly, e.g. lanes branch off, cross one another or merge.
- The carriageway is very narrow and winding.

### Activating/deactivating Lane Keeping Assist or Active Lane Keeping Assist

Multimedia system:

→ → Settings → Assistance

▶ Select Lane Keeping Assist or Act. Lane Keep. Asst On.

**Activating or deactivating warning**

- ▶ Select **Lane Keeping Assist** or **Act. Lane Keep. Asst On**.
- ▶ Select **Warning**.

**Work mode****Activating/deactivating power take-off**

Observe the following notes:

- if there is severe strain on the power take-off, e.g. due to a high power draw at high outside temperatures, the transmission oil temperature can increase to impermissible levels. In this case, operate the power take-off at regular intervals for about five to ten minutes under a partial load.
- only activate the power take-off when the vehicle is stationary and the transmission is in neutral position.
- make sure that the engine speed is not higher than 2500 rpm during operation.
- manual transmission is disabled in vehicles with shift lock when the power take-off is activated.
- you can engage 1st or 2nd gear and drive after activating power take-off in vehicles without shift lock. Do not change gear while the vehicle is in motion when power take-off is activated. Therefore, pull away in 1st or 2nd gear depending on the desired speed.
- observe the notes in the manufacturer's operating instructions before using the power take-off in conjunction with the body.

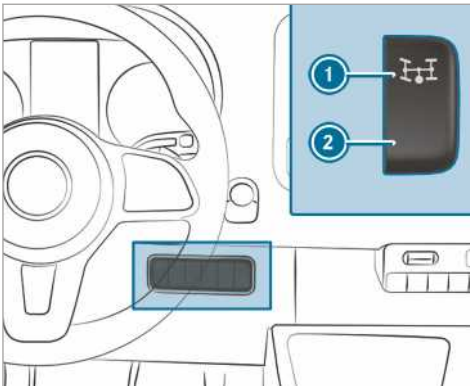

- ▶ **To activate:** stop the vehicle and shift the transmission to neutral.

- ▶ depress the clutch pedal.
- ▶ wait about five seconds and with the engine running press the upper section of the switch ①.
- ▶ release the clutch pedal.  
On vehicles with a working speed governor (ADR), the engine speed automatically increases to a preset speed or a speed you have set, the constant engine speed. The **Working speed governor active** and **Power take-off active** messages are shown in the multifunction display.
- ▶ **To deactivate:** stop the vehicle and shift the transmission to neutral.
- ▶ depress the clutch pedal.
- ▶ wait about five seconds and with the engine running press the lower section of the switch ②.
- ▶ release the clutch pedal.

**ADR (working speed control)****Function of ADR (working speed control)**

When activated, ADR automatically increases the engine speed to a preset speed or a speed you have set.

- ① After a cold start, the idle speed of the engine is increased automatically. If the preset working speed is lower than the increased idle speed, the working speed is only reached once the engine has completed the warm-up phase.

It is only possible to activate ADR with the vehicle stationary and the parking brake applied.

On vehicles with automatic transmission, the selector lever must be in position **P**.

## Activating/deactivating ADR

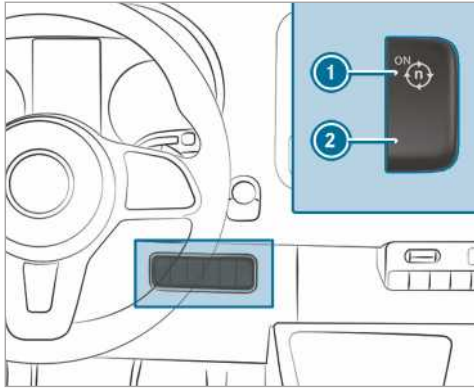

- ▶ **To activate:** while the engine is running, press the upper section of switch ①. The **Working speed governor active** message is shown in the multifunction display.
- ▶ **To deactivate:** while the engine is running, press the lower section of switch ②.

The ADR goes out automatically in the following situations:

- you release the parking brake.
- you depress the brake pedal.
- the vehicle moves.
- the control unit detects a malfunction.

## Adjusting ADR

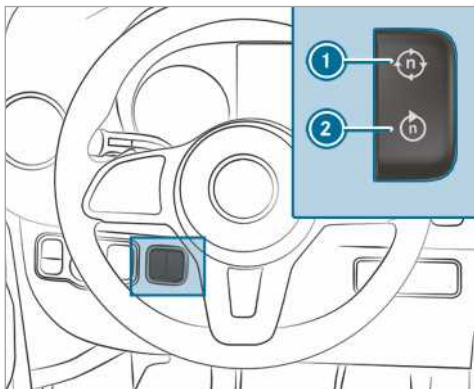

- ▶ Engage power take-off (→ page 168) or activate ADR.
- ▶ **To increase:** press the upper section of switch ①.

- ▶ **To decrease:** press the lower section of switch ②.

## Trailer operation

### Notes on towing a trailer

- ▲ **WARNING** Risk of accident- and injury if the load is exceeded

If you exceed the permitted load when using the rack, the rack system may disconnect from the vehicle and endanger other road users.

- ▶ Always comply with the permitted load when using the rack.

- ▲ **WARNING** Swerving of the car/trailer combination due to increased speed

If the car/trailer combination swerves, you can lose control of it.

The car/trailer combination can even tip over.

- ▶ Under no circumstances should you try to increase the speed to straighten the car/trailer combination.
- ▶ Reduce speed and do not counter-steer.
- ▶ If necessary, apply the brakes.

- ▲ **WARNING** Risk of accident due to the brake system overheating

If you leave your foot on the brake pedal when driving, the brake system may overheat.

This increases the braking distance and the brake system may even fail.

- ▶ Never use the brake pedal as a footrest.
- ▶ Do not depress the brake pedal and the accelerator pedal at the same time while driving.

If the trailer coupling is removable, it is essential to comply with the operating instructions of the trailer coupling manufacturer.

Place your car/trailer combination on surfaces that are as even as possible and secure it against rolling away (→ page 140). Couple and uncouple the trailer carefully.

When reversing the towing vehicle, ensure that there is no-one between the vehicle and the trailer.

If you do not connect the trailer to the towing vehicle correctly, the trailer may become detached. Once it has been connected and is roadworthy, the trailer must be in a horizontal position behind the towing vehicle.

Note the following regarding the drawbar load:

- Make full use of the maximum drawbar load, where possible
- Do not exceed or undershoot the permitted drawbar load

Do not exceed the following values:

- Permitted braked or unbraked towing capacity  
The maximum permissible towing capacity for trailers without a separate braking system is 750 kg
- Permitted rear axle load of the towing vehicle
- Permitted gross weight of the towing vehicle
- Permitted gross weight of the trailer
- Permitted gross towing weight
- Maximum permissible speed of the trailer

The relevant permitted values, which must not be exceeded, can be found in the following places:

- in your vehicle documents
- on the identification plate of the trailer hitch
- on the trailer's identification plate
- on the vehicle identification plate

If there are discrepancies between the values, the lowest one applies.

Before driving off, ensure the following:

- The tyre pressure on the rear axle of the towing vehicle has been set for the maximum load.
- The headlamps have been set correctly.

Your vehicle will act differently with a trailer relative to without a trailer.

The car/trailer combination:

- is heavier
- is restricted in its acceleration and gradient-climbing capability
- has a longer braking distance
- reacts more strongly to crosswind gusts
- requires more delicate steering
- has a larger turning circle

This can impair the vehicle's driving characteristics.

When driving with a car/trailer combination, always adapt your speed to the current road and weather conditions. Drive carefully. Keep a sufficient safe distance.

Comply with the maximum speed of 80 km/h or 100 km/h, even in countries in which higher speeds are permitted for car/trailer combinations.

Comply with the legally prescribed maximum speed for car/trailer combinations in force in the country in question. Before driving, consult the trailer's vehicle papers to see the maximum permissible speed for your trailer.

The trailer hitch is one of the most important vehicle parts for road safety. Comply with the instructions on operating, maintaining and servicing in the manufacturer's operating manual.

#### **Vehicles with a removable trailer coupling:**

reduce the risk of damage to the ball coupling. If you do not need the ball coupling, remove it from the ball coupling mount.

- ❗ When using a trailer, remember that PARKTRONIC is available only to a limited extent, if at all.
- ❗ The ball head height changes depending on the vehicle's load. In this case, use a trailer with a height-adjustable drawbar.

#### **Driving tips**

The maximum permissible speed for car/trailer combinations depends on the type of trailer. Before driving, consult the trailer's vehicle papers to see the maximum permissible speed for your trailer.

Your vehicle will act differently with a trailer relative to without a trailer, and will consume more fuel. In the case of a long and steep descent, you must select shift range **3**, **2** or **1** in good time.

- ❗ This also applies if the cruise control or the speed limiter is switched on.

You thereby make use of the braking effect of the engine and do not have to brake as often to control the speed. This relieves the load on the brake system and prevents the brakes from overheating and wearing too quickly. If you have to apply the brakes as well, do not keep your foot on the brake pedal. Instead, press it intermittently.

#### **Driving tips**

If the trailer sways, remember the following points:



- Do not accelerate under any circumstances.
  - Do not countersteer.
  - If necessary, apply the brakes.
- i** You can prevent the trailer from swaying and swerving by retrofitting stabiliser bars or trailer stability programs. You can obtain information from your authorised Sprinter dealer.
- Keep a larger distance than when driving without a trailer.
  - Avoid braking abruptly. If possible, brake gently first of all so that the trailer closes up behind your vehicle. Then, increase the braking force quickly.
  - The values given for gradient-climbing capabilities from a standstill refer to sea level. When driving in mountainous areas, note that the engine power, and therefore its gradient-climbing capability, decrease with increasing altitude.

### Attaching the ball coupling

**⚠ WARNING** Danger of accident- and injury due to incorrectly installed and secured ball coupling

If the ball coupling has not engaged, it can become detached during driving and endanger other road users.

- ▶ Engage the ball coupling as described and ensure that it is securely installed.

**⚠ WARNING** Danger of accident due to non-engaged ball coupling

If the ball coupling has not engaged, the trailer can become detached.

- ▶ Always engage the ball coupling as described and ensure that it is securely installed.

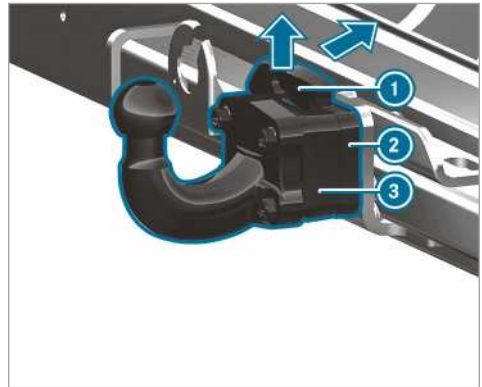

- ▶ Use the parking brake to secure the vehicle against rolling away.
- ▶ Pull safety spring **1** of ball coupling **3** upwards in the direction of the arrow, push it backwards and hold it in this position.

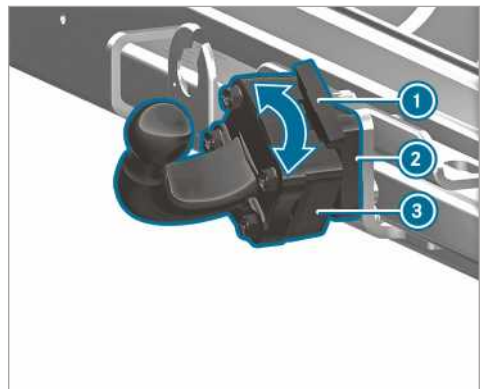

- ▶ Place ball coupling **3** onto ball coupling mount **2** and turn it in the direction of the arrow until ball coupling **3** points vertically upwards.
  - ▶ Re-attach safety spring **1**.
- i** If the ball coupling is dirty, clean it before installation.

## Detaching the ball coupling

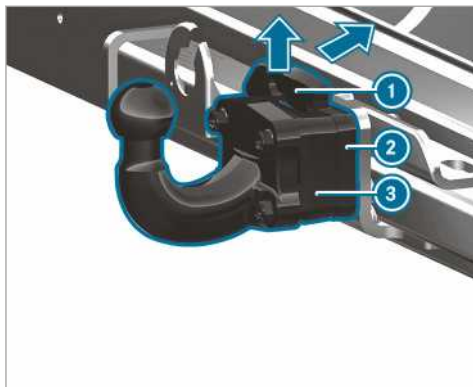

- ▶ Use the parking brake to secure the vehicle against rolling away.
- ▶ Pull the locking spring ① upwards in the direction of the arrow and push it to the rear.
- ▶ Hold the ball coupling ③ in place.
- ▶ Turn the ball coupling ③ in the direction of the arrow and remove it from the ball coupling mounting ②.
- ▶ If the ball coupling is dirty, clean it.
- ▶ Stow and secure the ball coupling properly.

## Coupling/uncoupling a trailer

### Requirements:

- The ball coupling must be engaged in a securely locked position.

Trailers with 7-pin plugs can be connected to the vehicle using the following adapters:

- Adapter plug
- Adapter cable

### Coupling a trailer

**!** **NOTE** Damage to the battery due to full discharge

Charging the trailer battery using the power supply of the trailer can damage the battery.

- ▶ Do not use the power supply to charge the trailer battery.

- ▶ **Vehicles with automatic transmission:** shift the selector lever to position **P**.
- ▶ Apply the vehicle's parking brake.

- ▶ Close all the doors.
- ▶ Remove the cover cap from the ball head and stow it away safely (→ page 73).
- ▶ **i** The ball head height changes depending on the vehicle's load. In this case, use a trailer with a height-adjustable trailer drawbar.
- ▶ Attach the trailer's breakaway cable to the eyelet on the ball coupling.
- ▶ Remove objects or devices that prevent the trailer from rolling, e.g. wheel chocks.
- ▶ Release the trailer's parking brake.
- ▶ Place the trailer in a horizontal position behind the vehicle and couple it.



- ▶ Open the cover of the socket.
- ▶ Insert the plug with the tab ① into the socket's groove ③.
- ▶ Turn the bayonet coupling ② to the right as far as it will go.
- ▶ Let the cover engage.
- ▶ Attach the cable to the trailer with cable ties (only in the case of adapter cable).
- ▶ Ensure that the cable has unobstructed movement for driving around bends.
- ▶ Push the combination switch upwards/downwards and check whether the correct turn signal light is flashing on the trailer.

Even if the trailer is connected correctly, a display message will nevertheless appear on the multi-function display in the following cases:

- LEDs have been installed on the trailer's lighting system.
- The minimum power (50 mA) of the trailer lighting is not reached.
- ▶ **i** You can connect accessories up to a maximum of 240 W to the permanent power supply.

## Uncoupling a trailer

**⚠ WARNING** Risk of being crushed and becoming trapped when uncoupling a trailer

When uncoupling a trailer with an engaged inertia-activated brake, your hand may become trapped between the vehicle and the trailer drawbar.

- ▶ Do not uncouple trailers with an engaged overrun brake.

Do not uncouple a trailer with an overrun brake in a state of overrun. Otherwise, the rebound of the overrun brake can damage your vehicle.

- ▶ **Vehicles with automatic transmission:** shift the selector lever to position **P**.
- ▶ Apply the vehicle's parking brake.
- ▶ Close all the doors.
- ▶ Apply the trailer's parking brake.
- ▶ Secure the trailer against rolling away with a wheel chock or similar object.
- ▶ Disconnect the electrical connection between the vehicle and trailer.
- ▶ Uncouple the trailer

## Overview of instrument display

**⚠ WARNING** Risk of accident due to an instrument display malfunction

If the Instrument Display has failed or malfunctioned, you may not recognise function restrictions applying to safety relevant systems.

The operating safety of your vehicle may be impaired.

- ▶ Drive on carefully.
- ▶ Have the vehicle checked immediately at a qualified specialist workshop.

If your vehicle's operational safety is impaired, park the vehicle in a safe location immediately. Inform a qualified specialist workshop.

### Instrument display

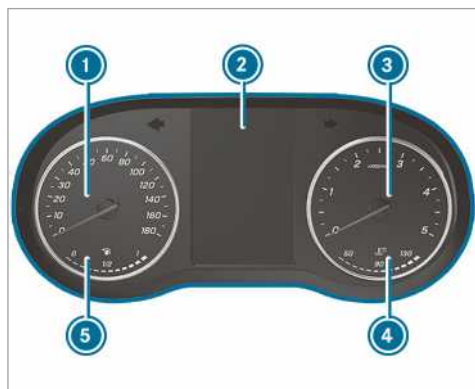

Instrument display with colour display (example)

- ① Speedometer
- ② Multifunction display
- ③ Rev counter
- ④ Coolant temperature display
- ⑤ Fuel level and tank cap position display

In normal driving mode, the coolant temperature display ④ is permitted to rise to 120 °C.

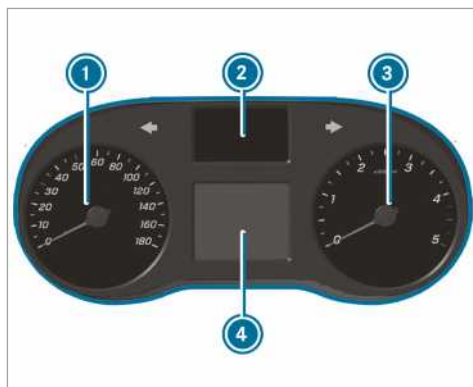

Instrument display with black and white display (example)

- ① Speedometer
- ② Indicator lamps display
- ③ Rev counter
- ④ Multifunction display

**! NOTE** Engine damage due to excessively high engine speeds

The engine will be damaged if you drive with the engine in the overrevving range.

- ▶ Do not drive with the engine in the overrevving range.

When the red marking in the rev counter ③ is reached (overspeed range), the fuel supply will be interrupted in order to protect the engine.







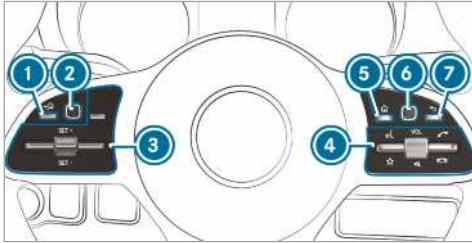

**⚠ WARNING** Danger of burns when opening the bonnet

If you open the engine bonnet when the engine has overheated or during a fire in the engine compartment, you could come into contact with hot gases or other escaping operating fluids.





- ▶ Before opening the bonnet, allow the engine to cool down.
- ▶ In the event of a fire in the engine compartment, keep the engine bonnet closed and call the fire service.

## Overview of the buttons on the steering wheel

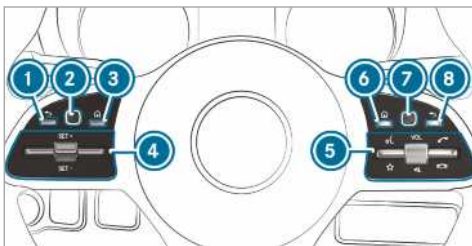



- ①  Back button, left (on-board computer)
- ② Touch Control, left (on-board computer)
- ③ Button group for cruise control or Active Distance Assist DISTRONIC
- ④ Button group:
  -  Voice-operated control
  -  Display favourites (multimedia system)
 VOL: using the  control, increases/reduces the volume or switches off the sound
  -  Makes/accepts a call
  -  Rejects/ends a call
- ⑤  Main menu button (multimedia system)
- ⑥ Touch Control, right (multimedia system)
- ⑦  Back button, right (multimedia system)



- ①  Back button, left (on-board computer)
- ② Touch Control, left (on-board computer)
- ③ Main menu button (on-board computer)
- ④ Button group for cruise control or Active Distance Assist DISTRONIC
- ⑤ Button group:
  -  Voice-operated control
  -  Display favourites (multimedia system)
 VOL: using the  control, increases/reduces the volume or switches off the sound
  -  Makes/accepts a call

 Rejects/ends a call

- ⑥  Main menu button (multimedia system)
- ⑦ Touch Control, right (multimedia system)
- ⑧  Back button, right (multimedia system)

## Operating the on-board computer

**⚠ WARNING** Risk of distraction from information systems and communications equipment

If you operate information and communication equipment integrated in the vehicle when driving, you will be distracted from the traffic situation. This could also cause you to lose control of the vehicle.

- ▶ Only operate this equipment when the traffic situation permits.
- ▶ If you cannot be sure of this, stop the vehicle whilst paying attention to road and traffic conditions and operate the equipment with the vehicle stationary.

When operating the on-board computer, comply with the legal requirements of the country in which you are driving.

### Operating the on-board computer (vehicles with steering wheel buttons)

- ① The display of the on-board computer appears on the multifunction display (→ page 176).

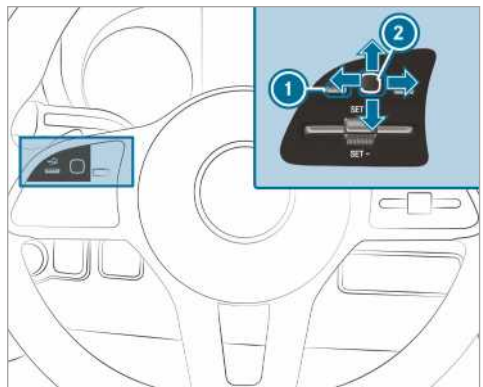

The on-board computer is operated via left-hand Touch Control ② and the back button on the left ①.

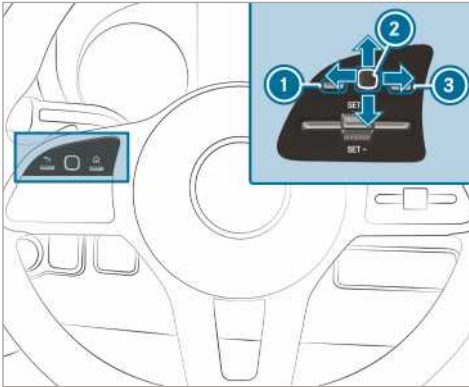

- ▶ **To browse through displays or lists in the menu:** swipe upwards or downwards on left-hand Touch Control ②.
- ▶ **To call up a submenu or confirm a selection:** press left-hand Touch Control ②.
- ▶ **To exit a submenu:** press the back button on the left ①.

If you are in a submenu and press and hold the back button on the left ①, the main menu appears.

**Overview of the displays on the multifunction display**

The on-board computer is operated using:

- the back button on the left ①
- the left-hand Touch Control ②
- the main menu button on the left ③

When the function has been switched on, different signal tones give feedback while the on-board computer is being operated, e.g.

- when the end of a list is reached
- when a list is being scrolled through

The following menus are available:

- Service
- Assistance
- Trip
- Navigation
- Radio
- Media
- Telephone
- Settings

▶ **To call up the main menu:** press the back button on the left ① repeatedly, or press and hold it.

① **Vehicles without Active Distance Assist DISTRONIC:** you can call up the main menu of the on-board computer with the  button.

▶ **To browse through the menu bar:** swipe to the left or right on left-hand Touch Control ②.

▶ **To call up a menu or confirm a selection:** press left-hand Touch Control ②.

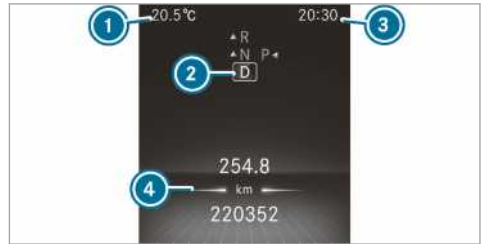

Instrument display with colour display

- ① Outside temperature
- ② Transmission position
- ③ Time
- ④ Display field



Instrument display with black and white display

- ① Outside temperature
- ② Display field
- ③ Time
- ④ Transmission position

Further displays on the multifunction display:

- ↑ Gearshift recommendation
-  Parking Assist PARKTRONIC switched off



Cruise control (→ page 150)



Active Distance Assist DISTRONIC (→ page 153)



Speed limiter (→ page 151)



DSR (→ page 128)



ECO start/stop function (→ page 120)



HOLD function (→ page 155)



Adaptive Highbeam Assist (→ page 84)



Maximum permitted speed exceeded (for certain countries only)



ATTENTION ASSIST deactivated



A door is not completely closed



Rear window wiper switched on (→ page 93)



LOW RANGE active (→ page 128)



Retarder (see separate operating manual)

SOS  
NOT  
READY

Emergency call system not active



Active Lane Keeping Assist switched off (→ page 166)



Active Brake Assist deactivated (→ page 148)



Blind Spot Assist switched off (→ page 164)

**Vehicles with Traffic Sign Assist:** detected traffic signs and messages (→ page 162).

## Setting the instrument lighting

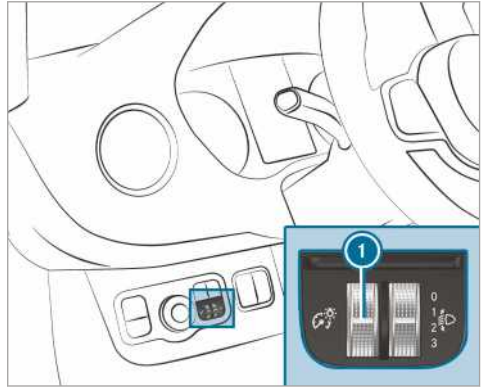

- ▶ Turn brightness control knob ① upwards or downwards.  
The lighting on the instrument display and the control elements in the vehicle interior is set.
- ① In vehicles without brightness control knob ①, the instrument lighting can be set via the on-board computer (→ page 181).

## Menus and submenus

### Calling up functions on the service menu

On-board computer:

- ↳ Service
- ▶ Select and confirm the required function.

Functions on the **Service** menu:

- **Messages:** message memory (→ page 345)
- **AdBlue:** Adblue® range
- **Tyres:**
  - Restart tyre pressure loss warning
  - Check tyre pressure with tyre pressure monitor (→ page 315)
  - Restart tyre pressure monitor (→ page 315)
- **ASSYST PLUS:** call up service date (→ page 270)
- **Engine oil level:** measure engine oil level
- **Particle filter:** start regeneration (→ page 121)
- **Long-term consumption**



## Calling up the assistant display

On-board computer:

→ Assistance

The following displays are available on the assistant display:

- Assistant display
- Attention level (→ page 161)

▶ Switch between the displays and confirm the selected display.

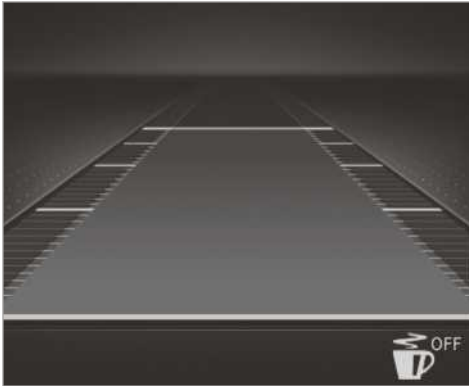

Instrument display with colour display

Status displays on the assistant display:

- : ATTENTION ASSIST switched off
- Lane markings bright: Lane Keeping Assist switched on
- Lane markings green: Lane Keeping Assist active
- Displays of Active Distance Assist DISTRONIC (→ page 153)



Instrument display with black and white display

Status displays on the assistant display:

- Lane markings dotted: Lane Keeping Assist switched off

- Lane markings solid and thin: Lane Keeping Assist switched on, not ready to issue warnings
- Lane markings solid and thick: Lane Keeping Assist ready to issue warnings

## Calling up displays on the trip menu

On-board computer:

→ Trip

▶ Select display.

The following displays are available on the Trip menu:

- Standard display
- Range and current fuel consumption  
With certain engines a recuperation display is also shown. If there is insufficient fuel in the fuel tank, a vehicle being refuelled is displayed instead of the approximate range.
- ECO display (→ page 120)
- Trip computer:
  - From start
  - From reset
- Digital speedometer

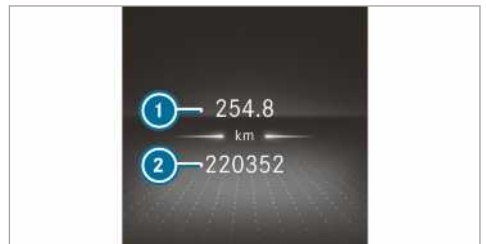

Instrument display with colour display  
Standard display (example)

- ① Trip distance
- ② Total distance

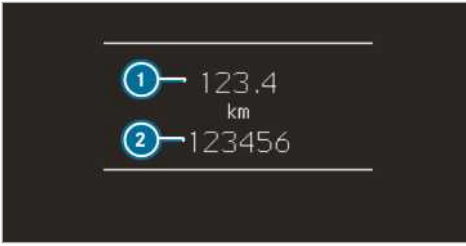

Instrument display with black and white display  
Standard display (example)

- ① Trip distance
- ② Total distance

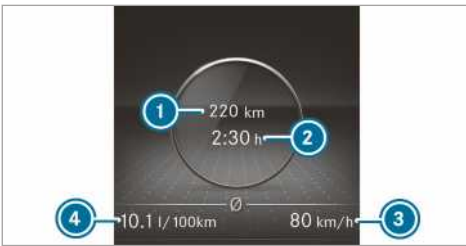

Instrument display with colour display  
Trip computer (example)

- ① Distance covered (from start / from reset)
- ② Driving time (from start / from reset)
- ③ Average speed (from start / from reset)
- ④ Average fuel consumption (from start / from reset)

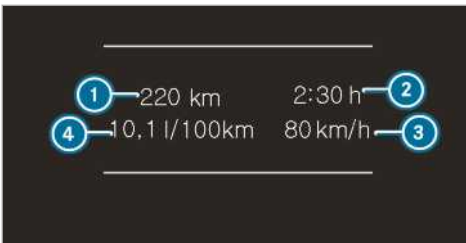

Instrument display with black and white display  
Trip computer (example)

- ① Distance covered (from start / from reset)
- ② Driving time (from start / from reset)
- ③ Average speed (from start / from reset)
- ④ Average fuel consumption (from start / from reset)

## Resetting values on the on-board computer trip menu

On-board computer:



- ① The spelling of the displayed main menu may differ. Therefore, pay attention to the menu overview for the instrument display (→ page 175).

You can reset the values of the following functions:

- Trip meter:
  - Reset trip meter?
- Trip computer:
  - From start
  - From reset
- ECO display

- ▶ Select the function that is to be reset and confirm this selection.
- ▶ Confirm the **Reset values?** prompt with **Yes**.

## Calling up navigation instructions in the on-board computer

On-board computer:



No change of direction announced (example)

- ① Distance to the next destination
- ② Estimated arrival time
- ③ Distance to the next change of direction
- ④ Name of current road



Change of direction announced (example)

- ① Street into which the change of direction leads
- ① Destination route of the change of direction
- ② Distance to the change of direction
- ③ Change of direction symbol
- ④ Recommended lane and the new lane that appears during the change of direction (white)
- ⑤ Possible lane
- ⑥ Unrecommended lane (dark grey)

Further possible displays on the menu **Navigation**:

- **Fahrtrichtung**: The direction of travel and the road currently being travelled are displayed.
- **New route...** or **Calculating route...**: A new route is being calculated.
- **Straße nicht erfasst**: The road is not known, e.g. it has only recently been constructed.
- **No route**: The route to the selected destination cannot be calculated.
- **Off map**: The map for the current position is not available.
- **Area of destination reached**: You have reached the target area.
- ☒: You have reached the destination or an intermediate destination.

- ▶ Exit the menu or select and confirm a destination. If a destination is entered and confirmed, route guidance starts.
- ▶ If route guidance was previously active, a query appears whether the current route guidance is to be terminated .
- ▶ Confirm the prompt. Route guidance is started.

### Selecting a radio station

On-board computer:

▶ Trip



- ① Frequency range
- ② Station
- ③ Name of the track
- ④ Artist's name

The following displays are available:

- Frequency range
- Station list

- ▶ Select the radio station's frequency or a radio station from the station list.
- ▶ Confirm the selection.

When you select a station in the station memory, the storage location appears beside the station name. When you select a saved station in the frequency range, a star appears beside the station name.

### Operating media playback with the on-board computer

On-board computer:

▶ Media



- ① Media source
- ② Current track and track number
- ③ Artist's name
- ④ Name of the album

Displays on the **Media** menu:

- Media source selection list
  - Current playback
- ▶ Select and confirm the media source.
  - ▶ Select and confirm the required playback.
- ⓘ This is how to select a station when TV is the media source.

## Dialling a telephone number using the on-board computer

### Requirements:

- The mobile phone is connected to the multi-media system.

On-board computer:

↳ Telephone

**⚠ WARNING** Risk of distraction from information systems and communications equipment

If you operate information and communication equipment integrated in the vehicle when driving, you will be distracted from the traffic situation. This could also cause you to lose control of the vehicle.

- ▶ Only operate this equipment when the traffic situation permits.
- ▶ If you cannot be sure of this, stop the vehicle whilst paying attention to road and traffic conditions and operate the equipment with the vehicle stationary.

When making a telephone call, comply with the legal requirements of the country in which you are driving.

- Previous calls
- Phone book
- Call status

**Vehicles with MBUX multimedia system:** The most recent telephone calls (dialled numbers, accepted and missed calls) are displayed on the **Telephone** menu.

- ▶ Select and confirm a telephone number.  
**If only one telephone number has been saved for the entry:** The telephone number is dialled.



- ▶ **If several telephone numbers have been saved for the entry:** Select and confirm a telephone number.  
The telephone number is dialled.



Instead of the selected telephone numbers, the following displays may appear:

- **Please wait...:** The application is currently starting. If a Bluetooth® connection to the mobile phone is not established, the menu for authorising and connecting a mobile phone appears on the multimedia system (→ page 235).
- **Updating data:** The call list is being updated.
- **Importing contacts:** The mobile phone's contacts, or a memory medium's contacts are being imported.

### Accepting/rejecting a call

If you receive a call, the display shows the **Incoming call** message.

- ▶ Press  to accept the call or  to reject it.

You can also accept or reject the call using the  or  buttons on the steering wheel.

## Calling up settings

On-board computer:

↳ Settings

The following entries can be set on the Settings menu:

- **Lights**
  - **Instrument lighting** Setting the instrument lighting
- **Vehicle**
  - Switching **Regensensor** (Rain sensor) on and off
- Setting **Heating**
- **Anzeige und Bedienung**
  - Switching permanent **Anzeige AdBlue Level** on and off

- ▶ Select an entry and confirm the selection.
- ▶ Make the necessary changes.

### Notes on operating safety

- ▲ WARNING** Risk of distraction from information systems and communications equipment

If you operate information and communication equipment integrated in the vehicle when driving, you will be distracted from the traffic situation. This could also cause you to lose control of the vehicle.

- ▶ Only operate this equipment when the traffic situation permits.
- ▶ If you cannot be sure of this, stop the vehicle whilst paying attention to road and traffic conditions and operate the equipment with the vehicle stationary.

- ▲ WARNING** Risk of distraction from operating mobile communication equipment while the vehicle is in motion

If you operate mobile communication equipment when driving, you will be distracted from the traffic situation. This could also cause you to lose control of the vehicle.

- ▶ Only operate this equipment when the vehicle is stationary.

For your own safety, always observe the following points when operating mobile communications equipment and especially your voice control system:

- Observe the legal requirements for the country in which you are driving.
- While driving, only operate mobile communications equipment and your voice control system when the traffic conditions permit it. You may otherwise be distracted from the traffic conditions and cause an accident, injuring yourself and others.
- If you use the voice control system in an emergency your voice can change and your telephone call, e.g. an emergency call, can thereby be unnecessarily delayed.
- Familiarise yourself with the voice control system functions before starting the journey.

### Operation

#### Multifunction steering wheel operation overview

LINGUATRONIC is operational approximately thirty seconds after the ignition is switched on.

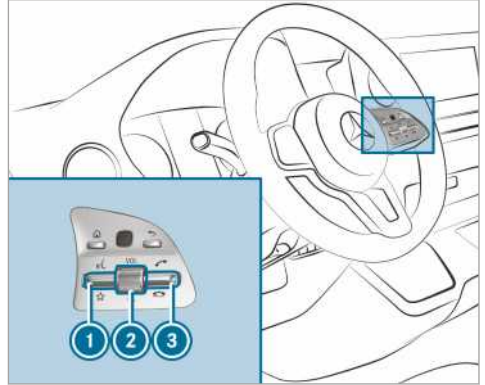

- ① Press the rocker switch up: starts the dialogue
- ② Press the control knob: switches the sound off or on (ends the dialogue)  
Turn the control knob up/down: increases/decreases the volume
- ③ Press the rocker switch down: rejects/ends a call (ends the dialogue)





#### Conducting a dialogue with LINGUATRONIC

For the dialogue with LINGUATRONIC, you can use complete sentences of colloquial language as voice commands, such as, for example, "Please show me the list of the last calls" or "How warm is it outside?". It is also not necessary to first change to the relevant application such as "Telephone" or "Vehicle function".

- ▶ **To activate or continue dialogue by using a keyword:** say "Hello Mercedes" to activate LINGUATRONIC. Voice activation must be switched on in the multimedia system. For this, it is not necessary to press up the rocker switch on the multifunction steering wheel.

Voice activation can also be directly combined with a voice command, e.g. "Hello Mercedes, how fast can I drive?".

or

- ▶ Press the  rocker switch up on the multi-function steering wheel.  
You can say a voice command after an acoustic signal.
- ▶ **To correct an entry:** say the Correction voice command.
- ▶ **To select an entry from the selection list:** say the line number or the contents.
- ▶ **To browse the selection list:** say the Next or Back voice command.
- ▶ **To interrupt the dialogue:** say the Pause voice command.  
The dialogue can be continued with the "Hello Mercedes" voice command or by pressing up the  rocker switch on the multifunction steering wheel.
- ▶ **To jump to the preceding dialogue:** say the Back voice command.
- ▶ **To jump back to the top dialogue level:** say the Home voice command.
- ▶ **To cancel the dialogue:** say the Close voice command or press the  or  button on the multifunction steering wheel.
- ▶ **To interrupt a voice output:** speak in the middle of a voice dialogue when the system is still answering.  
The voice output is shortened and the conclusion is reached more quickly.  
For this, the corresponding option must be activated in the system settings in the multimedia system.

## Operable functions

---

You can use the LINGUATRONIC voice control system to operate the following functions depending on the equipment:

- Telephone
- Text messages
- Navigation
- Address book
- Radio
- Media
- Vehicle functions

## Overview of types of voice commands

---

A distinction is made between the following voice commands:

- **Global voice commands** can be said at any time and regardless of the current application, e.g. the voice commands Navigate to, Call or Text message to.
- **Application-specific voice commands** are only available for the active application.

On the display next to the active application, examples of global voice commands and the corresponding application-specific voice commands are displayed on an autocue. The lists can be scrolled or operated by voice.

## Number entry functions

---

- The numbers allowed are zero to nine.
- Telephone numbers can be entered as single digits.

## Notes on the language setting

---

You can change the language of LINGUATRONIC via the system language settings. If the set system language is not supported by LINGUATRONIC, English will be selected.



LINGUATRONIC is available in the following languages:

- German
- English
- French
- Italian
- Dutch
- Polish
- Portuguese
- Russian
- Swedish
- Spanish
- Czech
- Turkish

## Using LINGUATRONIC effectively

### Help functions

You receive information and help for:

- **For optimal operation:** say the Voice control tutorial voice command or call up the Digital Owner's Manual with I want to read the Owner's Manual for LINGUATRONIC, for example. The full extent of the Digital Owner's Manual is available when the vehicle is stationary.
- **Current application:** on the multifunction steering wheel, press the  rocker switch up and say the Help voice command. You will receive suggestions and information about operation of LINGUATRONIC for the current application.
- **Continued dialogue:** say the Help voice command during a voice dialogue. You receive aligned information for each step of the dialogue.
- **Specific function:** say the voice command for the desired function, e.g. with "Hi Mercedes, I would like to have help with my radio" or, after pressing the  rocker switch on the multifunction steering wheel up, say the "Help for phone" voice command, for example.

### Notes on how to improve speech quality

#### If LINGUATRONIC does not understand you:

- activate online services. Recognition is improved.
- only operate LINGUATRONIC from the driver's seat.
- say the voice commands coherently and clearly, but do not exaggerate the words.
- avoid loud noises that cause interference while making a voice command entry, e.g. the entertainment in the rear-passenger compartment.
- say the voice tag with the same intonation when creating voice tags.

#### • For telephone or address book entries:

- only create sensible address book entries in the system/mobile phone, e.g. enter surname and first name in the correct field.
- do not use any abbreviations, unnecessary spaces or special characters.

- **For radio programme names:** say the Read out station list voice command and say the desired station name in the way the voice output reads aloud to you.

### Information on the online services

The online services enable improved recognition and provide better and additional results based on the external information, e.g. about weather or news. For this reason, we recommend you activate the online services.

To do this, you need a user account on the Mercedes PRO portal. If you do not yet have a user account, this must be created.

For more information consult a Mercedes-Benz service centre or visit the Mercedes PRO portal: <http://www.mercedes.pro>

## Basic voice commands

### Notes on the voice commands

Aside from the exact voice commands (see the "Voice command" column in the following tables) to call up specific functions, in most cases LINGUATRONIC also understands a great many paraphrases from daily usage. Examples of these are listed in the "Colloquial examples" column. For some languages however these examples are only available to a limited extent.

### Overview of switch voice commands

Switch voice commands can be used to open certain applications.



## Switch voice commands

Voice command	Colloquial example	Function
Switch to navigation	I would like to go to navigation	Switches to navigation
Switch to address book	I would like to switch to the address book	Switches to the address book
Switch to telephone	I would like to switch to the phone	Switches to the telephone
Switch to messages	Can you switch to messages please?	Switches to the messages application
Switch to radio	I would like to switch to the radio	Switches to radio
Switch to media	I would like to switch to the media application	Switches to media
Switch to comfort	I would like to go to the comfort application	Switches to the comfort settings
Switch to vehicle info	I would like to go to the vehicle application	Switches to vehicle information
Switch to settings	I would like to go to the settings menu	Switches to the menu with the setting options

### Overview of navigation voice commands

Using navigation voice commands, you can enter POIs or conventional addresses as well as directly change important navigation settings.

The following list offers just a small selection of the possible navigation commands. You will receive additional suggestions if you say Help for navigation.

### Navigation voice commands

Voice command	Colloquial example	Function
Navigate to <address>	Navigate to address "100 King Street, Leeds"	Starts navigation to an address in the address book directly
Navigate to <name>	Drive/bring me to the private address of John Smith	Destination entry to a contact in the address book
Home	Home/To my own address	Starts navigation to home address
Work	To my office/business/my job	Starts navigation to your workspace
Navigate to <POI>	Navigate me to McDonald's	Starts navigation to a POI directly

Voice command	Colloquial example	Function
Enter POI	Bring me to a POI	Destination entry for a POI, e.g. the POI Brandenburg Gate.
I would like to navigate to <POI>	Find/search in the Internet/web for a <POI>	Conducts a POI search on the Internet only
Enter address in <country>	I would like to enter a new address in "France"	Enters a destination in the desired country
Enter country	Enter a new country	Enters a country/town/district/junction/house number/postcode
Enter city	I would like to enter a specific address	
Search for district	I would like to look for a district	
Navigate to an intersection	Drive me to a crossing	
Enter the house number	Enter the number.	
Enter postcode	Start route guidance to a new postcode	
Last destinations	Show the previous destinations	
Show alternative routes	Search for alternative routes	Switches route guidance to another route
Start route guidance	I would like to start route guidance/Navigate there	Starts route guidance after entering a valid destination
Cancel route guidance	Can you quit route guidance?	Cancels route guidance
Driving recommendations on	Switch on driving recommendations	Switches the route guidance voice output on/off
Driving recommendations off	Mute the driving instructions	
Display the traffic map	Switch to the map with the traffic disruptions	Switches the traffic map on/off
Hide traffic map	Switch off the traffic jam messages	

Voice command	Colloquial example	Function
POI symbols on	Show the symbols on the map	Switches the POI symbols display on the map on/off
Hide POI icons	Delete the map symbols	

### Overview of telephone voice commands

You can use the telephone voice commands to make phone calls or search through the address book. The following list offers just a small selec-

tion of the possible telephone commands. You will receive additional suggestions if you say Help for phone.

### Telephone voice commands

Voice command	Colloquial example	Function
Call <telephone number>	I would like you to dial <telephone number>	Makes a telephone call by entering the telephone number directly
Call <contact>	Call Jane Smith on her mobile	Makes a telephone call directly by entering a name from the address book
Latest calls	Show me the list of missed calls	The list of missed calls is shown
Call name	Dial a name	Makes a phone call. All address book names are available.
Search for contact	Find a specific name in the phone book	Searches for a contact. All address book names are available.
Previous calls	Show the latest call list	Displays all outgoing, incoming and missed telephone calls.
Latest calls	Show me the list of missed calls	The list of missed calls is shown
Incoming calls	Show me the calls received	The list of incoming/outgoing calls is shown
Outgoing calls	Show me the list of outgoing calls	
Redial	Redial/Call last phone number	Selects the last phone number dialed
Change phone	Could you please switch to the second phone?	Changes the primary telephones
Call MB emergency	Could you call the mercedes benz emergency centre?	An emergency call is initiated
Call Mercedes PRO	Call Mercedes-Benz breakdown assistance	Mercedes PRO is called

## Overview of radio voice commands

Radio voice commands can also be used when the radio application runs in the background and another application is visible in the foreground.

The following list offers just a small selection of the possible radio commands. You will receive additional suggestions if you say Help for radio.

### Radio voice commands

Voice command	Colloquial example	Function
Station <station name>	Change to station/ channel Radio 1	To select the station/channel mentioned
Station <station name>	I would like to select station "Cool FM"	To select the radio station mentioned
Frequency <Fre- quency>	Go to station/radio frequency "eighty seven point five mega- hertz".	To enter a radio frequency, e.g. for the FM area
Next station	Find another station/ Change station	To switch to the next station that can be received
Next radio station	Call up the next radio station	The next radio station in a list is called up
Previous station	Switch to the last sta- tion/to the previous programme	To switch to the previous station
Save station	Save station name	To save the current station in the favourites list
Store radio stations	Save the radio station, please	To save a station name for a radio station
Show station list	Please show me the list of all stations	To show the list of stations that can be received
Read out station list	I'd like to listen to the station/programme list, please	To listen to the names of all receivable stations
Read out radio station list	Please read out the radio program	To have the list of available stations for the cur- rently selected radio application read aloud
Traffic information on	Switch on traffic info	To activate/deactivate traffic announcements
Traffic information off	Switch off traffic infor- mation	
Radio info on	I want you to turn on additional radio sta- tion text	To switch the current station information on/off

Voice command	Colloquial example	Function
Radio info off	I want you to turn off additional radio station text	
Tag this song	Tag the current song for me	To save a tag with information about the current track on the radio

### Overview of media player voice commands

Media player voice commands can also be used when the media player application runs in the background and another application is visible in

the foreground. The following list offers just a small selection of the possible media player voice commands. You will receive additional suggestions if you say Help for media or Help for player.

### Media player voice commands

Voice command	Colloquial example	Function
Play <track/albums/artists/composers/music genres/track lists>	Play "Hey Jude"	The names of all available tracks, albums, artists, composers, genres or playlists are accepted during the search. In the case of a clear search result the track found is played back immediately.
Play track <track>	Play song "So What"	The names of all available tracks, albums, artists, composers, genres or playlists are played back.
Play album <album>	Play album "A Night at the Opera"	
Play artist <artist>	I want to listen to the artist "Madonna"	
Play composer <composer>	I'd like to hear the composer "Ludwig van Beethoven"	
Play music genre <music genre>	I'd like to hear the music genre "Rock"	
Play back playlist <playlist>	I would like to listen to the playlist "Summer Hits 2000"	
Search for track <track>	I would like to search for the song "Sailing"	The names of all available tracks, albums, artists, composers, genres or playlists are accepted during the search. A selection list appears from which you can select the desired music. If you wish to play all the tracks in a selection list, say "Play all tracks".
Search for album <album>	Search for album "A Night at the Opera"	
Search for artist <artist>	I would like to search for the artist "Elton John"	
Search for composer <composer>	Search for composer "Beethoven"	

Voice command	Colloquial example	Function
Search for music genre <music genre>	Search for music genre "Pop"	
Search for playlist <playlist>	Search for playlist "Summer Hits 2008"	
Next track	Start the next song/ video clip/film	Plays back the next track on the current playlist
Previous track	Play the last song/ composition/clip again	Plays back the previous track on the current playlist
Repeat this track	I'd like to listen to this track again	The current track is played back from the beginning
Play similar music	I'd like to hear similar music	Similar tracks are played back
Play random music	Play me a random track	Random tracks are played back
Random track list on	Activate random mode	Switches on random mode
Random track list off	Switch off shuffle mode	Switches off random mode
Show me the current playlist	Go to the current playlist/track list	The current playlist is displayed
What am I listening to?	Which music is currently playing?	The information about the track currently playing is read aloud

### Overview of message voice commands

Text messages and e-mails can be created, edited and listened to using the message voice commands. The following list offers just a small selec-

tion of the possible message commands. You will receive additional suggestions if you say Help for messaging.

### Message voice commands

Voice command	Colloquial example	Function
Text message to <Name>	Dictate a new text message to my brother Ben	To create a text message. All address book names are available.
Text message to <Name><Text>	Write a new message to Ms. Anne Harvey, business: "When is the next meeting?"	To write a text message to the person called up. The content of the text can be spoken immediately if online voice control has been activated.
Forward text message	Forward text	To forward selected or open text messages.
Read out new text messages	Read out all new texts	To read out new text messages.

Voice command	Colloquial example	Function
Read out the last text message from <Name>	Read out last text message from "John, private"	The last text message from the person mentioned is read.
Reply	Send a message/e-mail/text message to the sender	To reply to a message
Reply in <language>	Reply to this message/text message in French	A reply is made to the message just read in another language.

### Overview of vehicle voice commands

You can use the vehicle voice commands to directly call up the corresponding menus for the vehicle settings. The following list offers just a

small selection of the possible vehicle voice commands. You will receive additional suggestions if you say Help for vehicle settings or Help for vehicle functions.

### Vehicle voice commands

Voice command	Colloquial example	Function
Current speed limit	Tell me the maximum permitted speed	To call up the current speed limit
Outside temperature	How cold is it outside?/How warm is it?	To call up the outside temperature
Average consumption	Read out the average fuel consumption	To call up average consumption
Vehicle data	Can you please display the vehicle data menu?	To call up vehicle data
Engine data	Can I switch to the motor menu?	To call up engine data
Next service	Tell me my next service appointment	To call up the next service due date
Range	Tell me the current range	To call up range data
Consumption	Open the consumption menu	To call up consumption settings
Display and styles menu	Go to display and styles menu settings	To show display settings
Assistance menu	Show me the driver assistance settings	To display assistance settings
Light menu	Switch to the light settings	To display light settings



## Overview and operation

### Overview of the multimedia system

**⚠ WARNING** Risk of distraction from information systems and communications equipment

If you operate information and communication equipment integrated in the vehicle when driving, you will be distracted from the traffic situation. This could also cause you to lose control of the vehicle.

- ▶ Only operate this equipment when the traffic situation permits.
- ▶ If you cannot be sure of this, stop the vehicle whilst paying attention to road and traffic conditions and operate the equipment with the vehicle stationary.

You must observe the legal requirements for the country in which you are currently driving when operating the multimedia system.

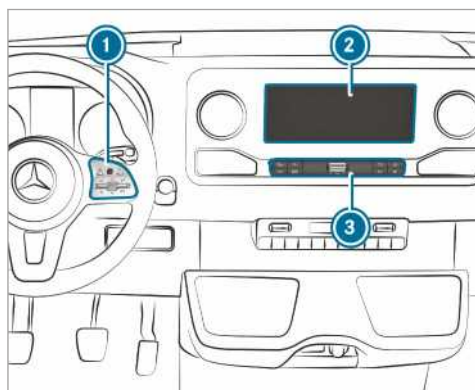

- ① Touch Control
- ② Multimedia system display with touch functionality  
Opening/closing the centre console stowage compartment above the display (→ page 75)
- ③ Operating strip, calls up applications

In the centre console stowage compartment you can find the following ports and interfaces:

- Two USB ports or one USB port  
The USB port with the  symbol facilitates the connection of the mobile phone with the multimedia system using a suitable cable. This will enable you to use the functions of

the mobile phone via Apple CarPlay™ or Android Auto.

- Stowage space with charging interface and NFC interface (if available)

You can operate the multimedia system with the following central control elements:

- Touch Control ①  
Operation takes place by cursor control.
- Multimedia system display ②
- Buttons on operating strip ③

Multiple applications are available for you. You can call these up using the home screen or using the buttons on operating strip ③.

You can conveniently call up and add favourites on the steering wheel using the  rocker switch. Quick-access in the home screen and in the applications serve to select functions more quickly.

If you use the learn function of the multimedia system, you will receive suggestions during operation of the most probable navigation destinations, radio stations and contacts. The configuration of the suggestions takes place in your profile. You can compile your profile from various vehicle settings and settings of the multimedia system.

The Notifications Centre collects incoming notifications, e.g. about an available software update. Depending on the type of notification it offers various actions.

With the global search in the vehicle you can search on-board across many categories as well as online in the Internet. Both functions call up the home screen.

### Anti-theft protection

This device is equipped with technical provisions to protect it against theft. More detailed information about anti-theft protection can be obtained at a qualified specialist workshop.

### Notes on the multimedia system display

Observe the notes on caring for the interior (→ page 281).

**Automatic temperature-controlled switch-off feature:** if the temperature is too high, the brightness is initially reduced automatically. The multimedia display may then switch off completely for a while.

- i** If you are wearing polarised sunglasses, it may be difficult to read the multimedia display.

## Home screen overview

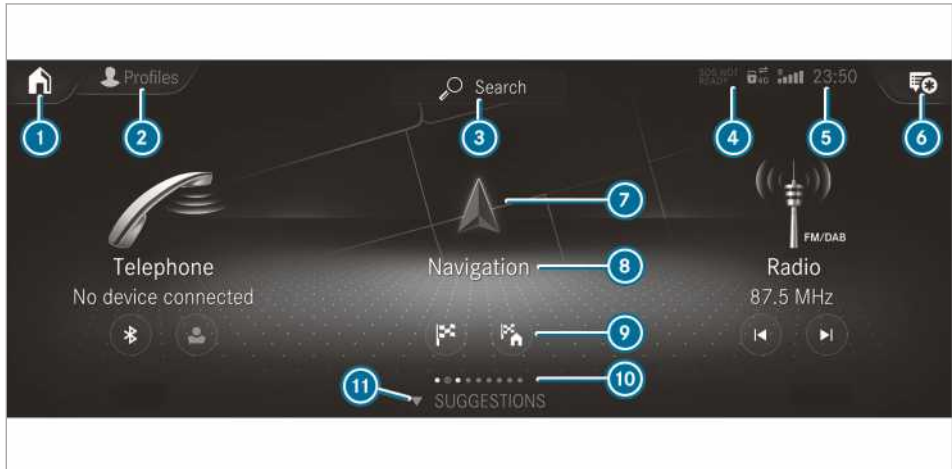

- 1** On the home screen: displays the first three applications  
In other displays: calls up the home screen
- 2** Calls up the profile
- 3** Calls up the global search
- 4** Display only when the Mercedes-Benz emergency call system is not available
- 5** Displays, for example network display, signal strength of the mobile phone network, time
- 6** Calls up the Notifications Centre  
The star indicates new notifications.
- 7** Calls up an application using the symbol
- 8** Name of the application, beneath the current selection or information
- 9** Quick-access
- 10** Number of applications and currently selected display area
- 11** Calls up **VORSCHLÄGE (SUGGESTIONS)** and **FAVOURITES**

## Touch Control

### Operating Touch Control (multimedia system)

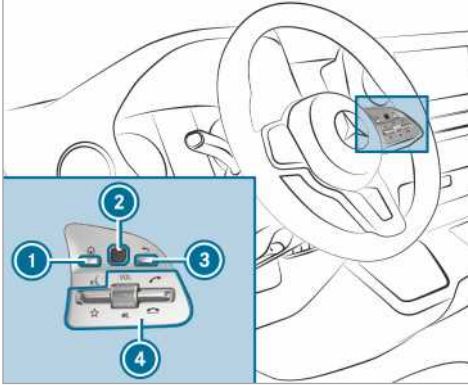

- ① button  
Calls up the home screen
- ② Touch Control
- ③ Back button  
Returns to the previous display
- ④ Control panel for multimedia system  
Press the rocker switch down: shows favourites  
Turn the control knob: sets the volume  
Press the control knob: switches sound off  
Press the rocker switch up: makes or accepts a call  
Press the rocker switch down: ends or declines a call

▶ **To call up the home screen:** press button ①.

or

- ▶ Press and hold button ③.
- ▶ **To open a menu or list:** press Touch Control ②.
- ▶ **To close a menu or list:** press button ③.
- ▶ **To select a menu item:** swipe up, down, left or right on Touch Control ②.
- ▶ Press Touch Control ②.
- ▶ **To move the digital map:** swipe in any direction.

### Setting the sensitivity for the Touch Control

Multimedia system:

→ ▶ Settings ▶ System ▶ Controls ▶ Touch Control sensitivity

▶ Select **Fast**, **Medium** or **Slow**.

### Switching acoustic operating feedback for the Touch Control on/off

Multimedia system:

→ ▶ Settings ▶ System ▶ Controls

The function is supported by the selection in a list.

▶ Select **Acoustic operating feedback**.

▶ Set **Normal**, **Loud** or **Off**.

If the function is activated you will hear a clicking sound when scrolling in a list. When the beginning or end of the list is reached you will hear another clicking sound.

## Operating the touchscreen

### Tapping

- ▶ **To select a menu item or entry:** tap on a symbol or an entry.
- ▶ **To increase the map scale:** tap twice quickly with one finger.
- ▶ **To reduce the map scale:** tap with two fingers.
- ▶ **To enter characters with the keyboard:** tap on a button.

### Single-finger swipe

- ▶ **To navigate in menus:** swipe up, down, left or right.
- ▶ **To move the digital map:** swipe in any direction.
- ▶ **To use handwriting to enter characters:** write the character with one finger on the touchscreen.

### Two-finger swipe

- ▶ **To zoom in and out of the map:** move two fingers together or apart.
- ▶ **To enlarge or reduce the size of a section of a website:** move two fingers together or apart.
- ▶ **To turn the map:** turn anti-clockwise or clockwise using two fingers.

## Touching, holding and moving

- ▶ **To move the map:** touch the touchscreen and move your finger in any direction.
- ▶ **To set the volume on a scale:** touch the touchscreen and move the finger to the left or right.

## Touch and hold

- ▶ **To save the destination in the map:** touch the touchscreen and hold until a message is shown.
- ▶ **To call up a global menu in the applications:** touch the touchscreen and hold until the **OPTIONS** menu appears.

## Applications

### Calling up applications

#### Using buttons on the operating strip

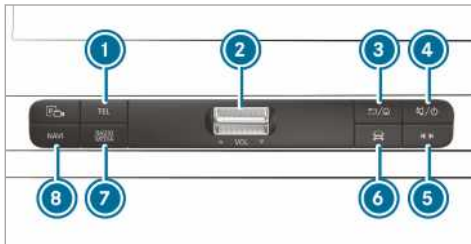

- ① **TEL** button  
Calls up the telephone
- ② Volume rocker switch  
Adjusts the volume (→ page 196)
- ③ **←** / **🏠** button  
Press briefly: returns to the previous display  
Press and hold: calls up the home screen
- ④ **🔇** / **🔌** button  
Press briefly: switches sound off  
Press and hold: activates/deactivates the multimedia system
- ⑤ Quick-access button for media  
Calls up the control menu of the last active media source
- ⑥ Vehicle button  
Sets vehicle functions
- ⑦ **RADIO** button **MEDIA**  
Pressing repeatedly calls up the desired audio source

- ⑧ **NAVI** button  
Calls up navigation

#### ▶ **To access stations and music tracks quickly:** press button ⑤.

The control menu appears for the audio source that was last selected.

#### ▶ Swipe to the left or right.

Radio: the previous or next station is set.

Media source: the previous or the next music track is selected.

#### ▶ **To hide the control menu:** press button ⑤.

### Using the home screen

The home screen is shown in the multimedia system display when you start the vehicle.

- ▶ Select the application by swiping and tapping.  
or

- ▶ **In any display:** press the **🏠** button on the Touch Control.

or

- ▶ Briefly press the **🏠** symbol in the multimedia system display.  
The applications are displayed.

- ▶ Select the application by swiping and tapping.

### Changing the arrangement of applications on the home screen

- ▶ Call up the home screen

- ▶ Touch and hold an application on the touchscreen until symbols appear.

- ▶ Tap on **◀** or **▶** and move the application in the menu.

- ▶ Tap on **🔍**.

## Switching the sound on/off

### On the multifunction steering wheel

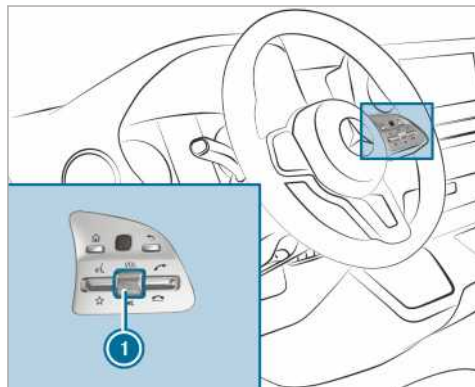

- ▶ **To mute:** press volume control ①.  
The  symbol appears in the status line of the multimedia system display.  
You will also hear traffic announcements and navigation announcements even when the sound is muted.
- ▶ **To switch on:** turn volume control ① or change the media source.

### On the multimedia system



- ▶ **To switch off:** briefly press button ①.  
The  symbol appears in the status line of the multimedia system display.  
You will also hear traffic announcements and navigation announcements even when the sound is muted.
- ▶ **To switch on:** change the media source or briefly press button ①.

## Adjusting the volume

### On the multifunction steering wheel

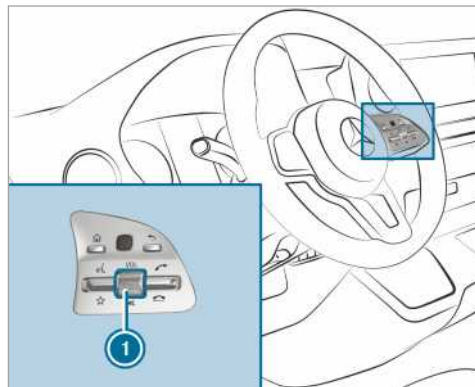

- ▶ Turn volume control ①.  
The volume of the current radio or media source is set. The volume of other audio sources can be adjusted separately.

Adjust the volume in the following situations:

- during a traffic announcement
- during a navigation announcement

The volume of the current media source changes in accordance with the volume of the navigation announcement.

- during a telephone call

### On the multimedia system

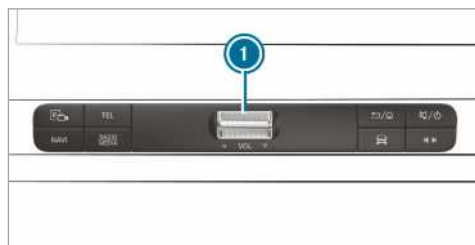

- ▶ **To raise/reduce the volume in steps:** briefly press rocker switch ① up or down.
- ▶ **To raise/reduce the volume continuously:** press rocker switch ① up or down until the desired volume is set.

## Profile

### Overview of profiles

Using the multimedia system up to seven profiles can be created in the vehicle.

Profiles store your personal vehicle settings and settings for the multimedia system.

If the vehicle is used by several drivers, the driver can select their profile before the journey, without changing the settings of other drivers.

You can select the profile:

- when entering (→ page 197)
- on the home screen (→ page 193)

The profile settings are activated as soon as a profile is selected.

### Profile content



The following settings can be saved in your profile, for example:

- Radio (including station list)
- Last destinations
- Favourites and suggestions

### Creating a new profile

Multimedia system:

→    Profiles

- ▶ Select  **Create profile**.
- ▶ Select an avatar.
- ▶ Enter the name and confirm with .
- ▶ Select **Continue** .
- ▶ **To select the profile basis:** select the settings with which you want to start your new profile, [Current system settings](#) or [Factory settings](#).
- ▶ Select **Save**.
- ▶ **To accept or reject data recording:** when the notification appears that the vehicle will offer personalised suggestions based on the navigation destinations visited, numbers called and music preferences, select **Accept** or **Reject**.  
[Accept](#) allows the data recording and enables the suggestions function.  
[Reject](#) rejects data recording.

### Selecting profile options

Multimedia system:

→    Profiles

- ▶ Select  for a profile.



- ▶ **To edit a profile:** select [Edit profile](#).
- ▶ Select an avatar.
- ▶ Change the name, if necessary.
- ▶ Select **Save**.
- ▶ **To configure suggestions:** select [Suggestions settings](#) (→ page 198).
- ▶ **To reset favourites:** select [Reset favourites to factory settings](#).
- ▶ Select **Yes**.
- ▶ **To reset a profile:** select [Reset profile to factory settings](#).
- ▶ Select **Yes**.
- ▶ **To delete a profile:** select [Delete profile](#).
- ▶ Select **Yes**.

 The guest profile cannot be deleted.

### Selecting a profile

Multimedia system:

→    Profiles

- ▶ Select a profile.
- ▶ Press the  button to confirm the message.  
The profile is loaded and activated.
-  Alternatively, the profile can already be selected when the vehicle is entered (→ page 197).

### Showing the profile selection when entering

#### Requirements:

- At least one profile has been created.

Multimedia system:

→    Profiles

- ▶ Select [General settings](#).
- ▶ Activate [Show profile selection when entering](#).  
When the vehicle is started, the multimedia system display shows the active profile.

## Suggestions

### Suggestions overview

The vehicle can learn the habits of the driver. Based on previously used functions, the most likely navigation destinations, music tracks, radio stations or contacts are offered under [SUGGESTIONS](#).

Suggestions are shown when the following requirements are fulfilled:

- A profile has been created (→ page 197).  
No suggestions are available in the **Guest** profile.
- A profile has been selected.
- You have accepted data recording.
- From the beginning of usage, the multimedia system must analyse the user habits. When sufficient data is collected then the suggestions are available.

If the requirements mentioned are not fulfilled, a preview with a description of the function appears in the **SUGGESTIONS** menu.

You can configure data recording (→ page 198) or delete the suggestions recorded (→ page 198).

### Calling up suggestions





#### Requirements:

- a profile has been created and is selected (→ page 197).  
This **Guest** profile is selected when the vehicle is purchased.

- ▶ Briefly press  in the multimedia system display.  
The home screen is shown.
- ▶ Swipe up until the **SUGGESTIONS** menu is shown.
- ▶ Select a navigation destination, a music track, a radio station or a contact.  
If route guidance is already active, you cannot start a new route guidance or set an intermediate destination for the existing route.

### Configuring suggestions

Multimedia system:

- ▶    Profiles
- ▶ Select  for a profile.
- ▶ Select **Suggestions settings**.
- ▶ **To switch suggestions display on/off:**  
switch **Allow destination suggestions**, **Allow music suggestions** and **Allow contact suggestions** on or off.  
If an option is switched on, suggestions for navigation destinations, music tracks, radio stations or contacts are shown.  
If the option is switched off, no suggestions are shown.

- ▶ **To deactivate the learn function for one day:** activate **Deact. learn. for 24h**.  
For 24 hours no new actions will be trained and no data recorded for the active profile. Suggestions will continue to be shown. The remaining time is shown next to **Deact. learn. for 24h**.

Before the time runs out, a message is shown that the multimedia system will continue the learn function shortly.

Example: if the option is switched on and a route to a new destination has been calculated, this destination would not be taken into account for the learn function.

- ▶ **To reset the suggestion history:** select **Reset suggestion history**.

- ▶  This process cannot be reversed.
- ▶ Select **Yes**.

### Renaming suggestions

Only navigation destinations can be renamed.

- ▶ Briefly press the  symbol in the multimedia system display.  
The home screen is shown.
- ▶ Swipe up until the **SUGGESTIONS** menu is shown.
- ▶ Highlight a navigation destination and press until the **OPTIONS** menu is shown.
- ▶ Select **Rename**.
- ▶ Enter the name.
- ▶ **To confirm the entry:** select **Yes**.

### Deleting a suggestion

- ▶ Briefly press  in the multimedia system display.  
The home screen is shown.
- ▶ Swipe up until the **SUGGESTIONS** menu is shown.
- ▶ Highlight a suggestion and press until the **OPTIONS** menu is shown.
- ▶ Select **Delete**.

### Deleting suggestions in the applications

You can delete suggestions in the previous destinations, in the radio station list and in the contacts.

- ▶ Select  for a suggestion.
- ▶ Select **Do not suggest**.

- ▶ **To delete the suggestion from the current list:** select **Not now**.  
The suggestion will be shown again at a later time in the list.
- ▶ **To delete a suggestion permanently:** select **Never**.
- ▶ Select **Yes**.  
The suggestion will not be shown again in future. All suggestions are reset.
- ▶ **To cancel the function:** select **Cancel**.

## Favourites

### Overview of favourites

Favourites offer you quick access to frequently used applications. It is possible to create 20 favourites in total.

You can select favourites from categories or you add favourites directly from an application.

### Calling up favourites

#### In the multimedia system display



- ▶ Tap on .  
The home screen is shown.
- ▶ Swipe up until **FAVOURITES** is shown.

#### Using the steering wheel

- ▶ Press the  rocker switch on the steering wheel down.

### Adding favourites

#### Selecting favourites from categories

- ▶ Briefly press  in the multimedia system display.  
The home screen is shown.
- ▶ Swipe up until **FAVOURITES** is shown.
- ▶ Select  **Create favourite**.  
The categories are displayed.
- ▶ Select the category.  
The favourites are displayed.
- ▶ Select a favourite.  
The favourite is stored at the next available position.
- ▶ **All positions in the favourites are taken:** confirm the message shown with **OK**.  
A list shows all the favourites.
- ▶ Select a favourite which should be overwritten.

### Adding a favourite from an application

Examples of adding from an application are:

- Saving a contact.
- Storing a radio station.
- Adding a media source.
- Saving a navigation destination.

#### ▶ **To save a contact as a global favourite:**



- select a contact (→ page 239).  
The details are displayed.
- ▶ Press on a phone number until the **OPTIONS** menu is shown.
- ▶ Select **Save as favourite**.  
The contact is added as a favourite.
- ▶ **To store a radio station as a global favourite:** set a radio station (→ page 261).
- ▶ Press on the radio station until the **OPTIONS** menu is shown.
- ▶ Select **Save as favourite**.  
The radio station is added as a favourite.

### Renaming favourites

- ▶ Briefly press  in the multimedia system display.  
The home screen is shown.
- ▶ Swipe up until **FAVOURITES** is shown.
- ▶ Press on a favourite until the **OPTIONS** menu is shown.
- ▶ Select **Rename**.
- ▶ Enter the name.
- ▶ Select **OK**.

### Moving favourites

#### Moving favourites in the favourites menu

- ▶ Briefly press  in the multimedia system display.  
The home screen is shown.
- ▶ Swipe up until **FAVOURITES** is shown.
- ▶ Press on a favourite until the **OPTIONS** menu is shown.
- ▶ Select **Move**.
- ▶ Move the favourite to the new position.
- ▶ Tap on .

#### Moving the favourites menu in the personalisation

- ▶ Briefly press  in the multimedia system display.  
The home screen is shown.



- ▶ Swipe up until **Set new order** is shown.
- ▶ Select **Set new order**.
- ▶ Move **Favourites** to the new position.
- ▶ Tap on .
- ▶ **To close the menu:** select **Close**.

### Deleting favourites

- ▶ Briefly press  in the multimedia system display.  
The home screen is shown.
- ▶ Swipe up until **FAVOURITES** is shown.
- ▶ Press on a favourite until the **OPTIONS** menu is shown.
- ▶ Select **Delete**.
- ▶ Select **Yes**.

## Notifications Centre

### Overview of the Notifications Centre

The following communications are collected in the Notifications Centre:

- Communications which are generated by the vehicle or from multimedia system.
- Communications which are received through the use of services.

The following notification types are available for you:

- Navigable destinations and routes
- Messages (text messages)
- System information, e.g. software update available
- Other notifications, e.g. from additional online services that can be subscribed to

The Notifications Centre  can be found on the home screen, in menus and at the top right of the navigation map (→ page 193).

A star in the symbol informs you of new notifications.

Notifications are normally briefly shown as they are received. This occurs for nearly every application that you are currently using. If you take no action, these are stored for future access in the Notifications Centre.

The notifications are sorted chronologically. The most recent notifications are at the top.

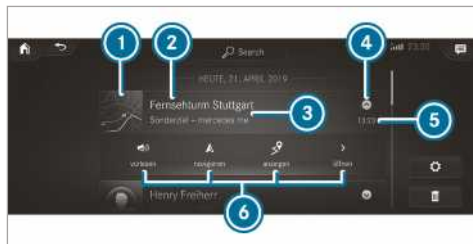

A notification shows the following information:

- Symbol or image ① for the application
- Title ②, which contains the name, a telephone number or a navigation destination
- The service and additional information ③
- A time stamp ⑤
- If several actions are available, symbol ④ to open or close the notification.

Depending on the type of notification, up to four different actions ⑥ are available.

Examples of actions include:

- Read aloud
- Placing a call
- Replying
- Calling up a web page
- Navigating

Some notifications, e.g. a navigation destination, are stored longer. Therefore, it is not necessary to carry out available actions directly on the receipt of the notifications. A route guidance can be started at a later time.

 You can start a global search in the Notifications Centre (→ page 201).

### Calling up notifications

Multimedia system:



### Opening the Notifications Centre

▶ **On the multimedia system display:** press briefly on the  symbol for the Notifications Centre.

or

▶ **On the Touch Control:** mark the  symbol for the Notifications Centre by swiping.  
▶ Press on the control element.

### Selecting a notification

▶ Swipe up or down.

- ▶ Tap or press on the control element.

### Selecting actions for a notification

The following options are available:



- Select the action directly in an application after a notification is received and shown.
- Select the action later after calling up in the Notifications Centre.

- ▶ **An action is available:** select the action.
- ▶ **Several actions are available:** if the notification is not open, select the  symbol.
- ▶ Select the action.  
The notification is still available.

### Editing notifications

Multimedia system:



- ▶ Call up the Notifications Centre (→ page 200).
- ▶ **To make settings:** select .
- ▶  If no settings can be made, a message appears.
- ▶ Activate or deactivate the setting.
- ▶ **To delete:** select the recycle bin.
- ▶ Select **Delete** or **Delete all**.  
**Delete** deletes a single notification.  
**Delete all** deletes all notifications currently shown.
- ▶ With **Finished** you will exit delete mode.

## Global search

### Global search overview

You can use the global search in the home screen and in the notifications.

The global search provides search results for the following categories and their sub-categories:

- Navigation
- Media
- Telephone, social media
- User interface and Digital Owner's Manual
- Internet

This enables you to search for towns, roads and tourist attractions with the navigation system, for example.

- ▶  You can also search for three-word addresses (→ page 215).

During the entry process the most likely suggestions are shown beneath the search field. When you enter "S", "Stuttgart", "Steak" and "Sandra" are shown, for example. If you select "Stuttgart", you receive the suggestions "Starbucks", "Steak" and "City railway", for example.

The search results in the list are shown, sorted according to category. Next to the category is the number of results. You will be shown the best results from each category. Additional results can be found after selecting the respective category.

If you confirm an entry with **OK**, all categories and the number of results will be shown in a summary. After selecting a category you can select the search results within the category. When you select a search result the detailed view opens. In the detailed view you can choose whether and which actions you want to carry out with the respective search result. For example, you can start route guidance or place a call to somebody. The actions are named correspondingly.



The search can be carried out with the following input methods:

- Entering characters using the on-screen keyboard
- Entering characters with handwriting recognition
- Dictation function

### Using the global search

Multimedia system:



- ▶ Select  **Search**.
- or
- ▶ Call up the notifications (→ page 200).
- ▶ Select **Search**.
- ▶  Alternatively, you can use the  dictation function for the search.
- ▶ Enter the search term into the search field. Use the character input function  
During the entry process the three most likely suggestions are offered beneath the search field.  
In the list on the right, the top two search results are shown for each category.
- ▶ **To accept a suggestion:** select the suggestion.  
The three most likely suggestions are offered.
- ▶ Continue the search or accept a suggestion.

- ▶ **To accept the second search result:** select the search result.  
An action starts or a list is shown.
- ▶ Select a search result or an action in the list.
- ▶ **To show all categories:** select **OK**.
- ▶ **To show search results for a category:** select a category.
- ▶ **To show details:** select a search result.
- ▶ **To start an action:** select an action.  
After selection of an action, a track is played back or the route to a destination is calculated, for example.

## Entering characters

### Using the character input function

**▲ WARNING** Risk of distraction from information systems and communications equipment

If you operate information and communication equipment integrated in the vehicle when driving, you will be distracted from the traffic situation. This could also cause you to lose control of the vehicle.

- ▶ Only operate this equipment when the traffic situation permits.
- ▶ If you cannot be sure of this, stop the vehicle whilst paying attention to road

and traffic conditions and operate the equipment with the vehicle stationary.

You must observe the legal requirements for the country in which you are currently driving when operating the multimedia system.

Character entry can be carried out with these control elements:

- Touch Control
- Touchscreen (multimedia system display)

Character entry takes place by cursor control when using the Touch Control.

Character input can be started with a control element and resumed with another.

- ▶ When the keyboard is shown, enter the characters on the control element by swiping and pressing or by tapping (touchscreen).

or

- ▶ Write the character on the touchscreen.

Examples of character entry:

- Renaming a favourite
- Entering a destination address in the navigation system
- Entering a web address

## Entering characters on the touchscreen

## Using the keyboard

### Requirements:

- An online connection is required for some functions.



- |  |  |   |
|--|--|---|
| ① Input line   | ⑤ Accepts an entry                                     | ABC switches to letters (level 2)   |
| ② Displays suggestions during entry  | ⑥ Switches to handwriting input                        | ⑪ Pressing or pressing briefly switches between upper-case and lower-case letters |
| ③ Deletes the entry  | ⑦ Enters a space                                       | Pressing and holding switches to upper-case letters permanently                   |
| ④ Deletes<br>Pressing or pressing briefly deletes the last character entered<br>Pressing and holding deletes the entry | ⑧ Changes the keyboard language                        |   |
|  | ⑨ Switches to special characters                       |   |
|  | ⑩ Switches to digits and additional special characters |   |

If available, a microphone symbol allows you to change to voice input.

- ▶ Call up the character entry to rename a favourite, for example (→ page 199). The keyboard is shown.
- ▶ Press briefly on a character key. The character is entered in input line ①. Suggestions are shown in ②.
- ▶ **To select a suggestion:** select one of the entries.

- ▶ If available, display additional suggestions with  or .
- ▶ Resume character input.
- ▶ **To enter an alternative character:** press and hold a character.
- ▶ Select the character.
- ▶ **To end character input:** press the  button.



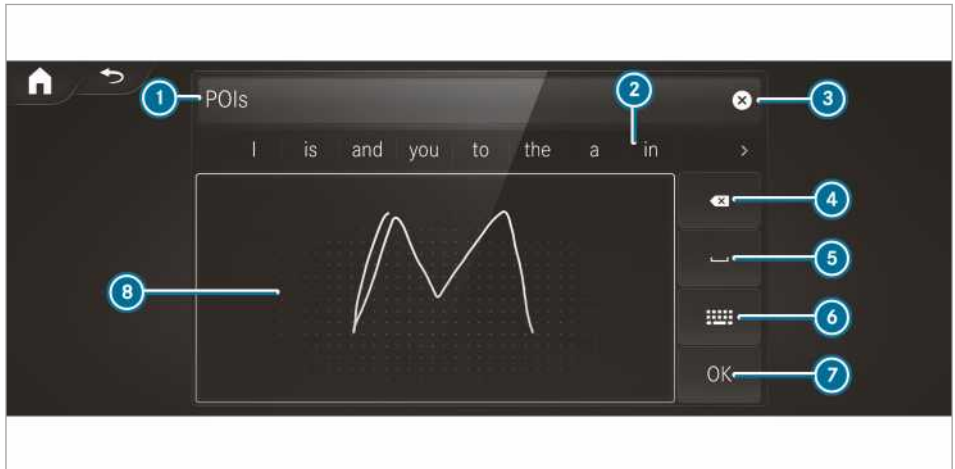

- i** The available editing functions depend on the editing task, the language set and the character level.

## Using handwriting input



- |                                     |   |  |
|-------------------------------------|---|--|
| ① Input line                        | Pressing or pressing briefly deletes the last character entered | ⑥ Switches to input using the keyboard     |
| ② Displays suggestions during entry | Pressing and holding deletes the entry                          | ⑦ Accepts an entry                         |
| ③ Deletes the entry                 |   | ⑧ Writes characters on the drawing surface |
| ④ Switches to voice input           | ⑤ Enters a space  |  |
| ④ Deletes                           |   |  |

If available, a microphone symbol allows you to change to voice input.

- ▶ Call up the character entry to rename a favourite, for example (→ page 199).
- ▶ When the keyboard is displayed, select .
- ▶ Write the character with one finger on the touchscreen. The character is entered in input line ①. Suggestions are shown in ②.
- ▶ **To select a suggestion:** select one of the entries.
- ▶ If available, display additional suggestions with  or .
- ▶ Resume character input. The letters can be written next to each other or above each other.
- ▶ **To end character input:** press the  button.

## Setting the keyboard for character entry

Multimedia system:

 [Settings](#) ▶ [System](#) ▶ [Controls](#) ▶ [Keyboards and handwriting](#)

- ▶ Confirm [Select keyboards](#).  
Select the keyboard language in the list.

## System settings

### Display

## Configuring display settings

Multimedia system:

  ▶ [Settings](#) ▶ [System](#) ▶ [Styles & display](#)

## Styles

- ▶ Select [Classic](#), [Sport](#) or [Progressive](#).

## Display brightness

- ▶ Select [Display brightness](#).
- ▶ Select a brightness value.

## Switching the display off/on

- ▶ **Off:** select [Display off](#).
- ▶ **On:** press a button, , for example.

## Display design

- ▶ Select [Day/night design](#).
- ▶ Select [Automatic](#), [Day design](#) or [Night design](#).

## Time and date

### Setting the time and date automatically

Multimedia system:

→  ▶ [System](#) ▶ [Time and date](#)

- ▶ Deactivate  [Manual time adjustment](#). The time and date are set automatically for the selected time zone and summer time option.
- ⓘ The correct time is required for the following functions:
  - Route guidance with time-dependent traffic guidance.
  - Calculation of expected time of arrival.

### Setting the time zone

#### Requirements:

- **For setting the time zone manually:** the [Automatic time zone](#) function is activated.

Multimedia system:

→  ▶ [Settings](#) ▶ [System](#) ▶ [Time and date](#)

### Setting the time zone manually

- ▶ Select [Time zone](#).

The list of countries is displayed.

- ⓘ If there are several time zones available in a country, these will be shown after the country is selected.
- ▶ Select a country and, if required, a time zone. The time zone set is displayed after [Time zone](#).

### Setting the time zone automatically

- ▶ Activate [Automatic time zone](#).

### Setting the time and date format

Multimedia system:

→  ▶ [Settings](#) ▶ [System](#) ▶ [Time and date](#) ▶ [Set format](#)

- ▶ Set the date and time format •.

## Setting the time and date manually

### Requirements:

- The [Manual time adjustment](#) function is switched on.
- **For setting the date manually:** no GPS is installed in the vehicle.

Multimedia system:

→  ▶ [Settings](#) ▶ [System](#) ▶ [Time and date](#)

### Setting the time

- ▶ Select [Set time](#).
- ▶ Set a time.
- ⓘ In vehicles with GPS the time is set automatically through the selected time zone.

### Setting the date

- ▶ Select [Set date](#).
- ▶ Set a date.
- ⓘ In vehicles with GPS, a date cannot be set even with active manual time adjustments. The date is then set automatically through the selected time zone.

## Bluetooth®

### Information about Bluetooth®

Bluetooth® technology is a standard for short-range wireless data transfer up to approximately 10 m. You can use Bluetooth® to connect your mobile phone to the multimedia system and use the following functions, for example:

- Hands-free system with access to the following options:
  - Call lists (→ page 241)
- Internet connection
- Listening to music via Bluetooth® audio
- Transferring business cards (vCards) into the vehicle

Bluetooth® is a registered trademark of Bluetooth Special Interest Group (SIG) Inc.

- ⓘ Internet connection via Bluetooth® is not available in all countries.

### Activating/deactivating Bluetooth®

Multimedia system:

→  ▶ [System](#) ▶ [Wi-Fi & Bluetooth](#)

- ▶ Activate or deactivate Bluetooth®.

## Wi-Fi

### Wi-Fi connection overview

You can use Wi-Fi to establish a connection with a Wi-Fi network and to access the Internet or other network devices.

The following connection options are available:

- Wi-Fi connection  
The Wi-Fi connection is established to a Wi-Fi-capable device, e.g. to the customer's mobile phone or tablet PC.
- Multimedia system as a Wi-Fi hotspot  
Using this function, a tablet PC or notebook can be connected, for example.

To establish a connection, you can use the following methods:

- WPS PIN  
The connection to a secure Wi-Fi network is made via a PIN.
- WPS PBC  
The connection to a secure Wi-Fi network is made by pressing a button (push button).
- Security key  
The connection to a secure Wi-Fi network is made via a security key.

### Setting up Wi-Fi

#### Requirements:

- The device to be connected supports one of the three means of connection described.

Multimedia system:

 **Settings** **System** (System) **Wi-Fi & Bluetooth**

#### Activating/deactivating Wi-Fi

- ▶ Switch **Wi-Fi** on or off.  
If **Wi-Fi** is deactivated, communication via Wi-Fi to all devices is interrupted. This also means that a connection to the communication module cannot be established. Then some functions such as dynamic route guidance with Live Traffic Information are not available.

#### Connecting the multimedia system with a new device via Wi-Fi

This function is available if a communication module is not installed.

The type of connection established must be selected on the multimedia system and on the device to be connected.

- ⓘ The connection procedure may differ depending on the device. Follow the instructions that are shown in the display. Further information (see the manufacturer's operating instructions).

- ▶ Select **Internet settings**.
- ▶ Select **Connect via Wi-Fi**.
- ▶ Select **Add hotspot**.

#### Connecting using a security key

- ▶ Select the options  of the desired Wi-Fi network.
- ▶ Select **Connect using security key**.
- ▶ Have the security key displayed on the device to be connected (see the manufacturer's operating instructions).
- ▶ Enter this security key on the multimedia system.
- ▶ Confirm the entry with **OK**.
- ⓘ All devices support a security key as a means of connection.

#### Connecting using a WPS PIN

- ▶ Select the options  of the desired Wi-Fi network.
- ▶ Select **Connect using WPS PIN input**.  
The multimedia system generates an eight-digit PIN.
- ▶ Enter this PIN on the device to be connected.
- ▶ Confirm the entry.

#### Connecting using a button

- ▶ Select the options  of the desired Wi-Fi network.
- ▶ Select **Connect via WPS PBC**.
- ▶ Select "Connect via WPS PBC" in the options on the device to be connected (see the manufacturer's operating instructions).
- ▶ Press the WPS button on the device to be connected.
- ▶ Select **Continue** in the multimedia system.

#### Activating automatic connection

- ▶ Select **Connect via Wi-Fi**.
- ▶ Select the options  of the desired Wi-Fi network.
- ▶ Activate **Permanent Internet connection**.

### Connecting with a known Wi-Fi

- ▶ Select **Connect via Wi-Fi**.
- ▶ Select a Wi-Fi network.  
The connection is established again.

### Setting up a Wi-Fi hotspot

Multimedia system:

- ▶  ▶ **Settings** ▶ **System (System)** ▶ **Wi-Fi & Bluetooth**

### Configuring the multimedia system as a Wi-Fi hotspot

The type of connection established depends on the device to be connected. The function must be supported by the multimedia system and by the device to be connected. The type of connection established must be selected on the multimedia system and on the device to be connected.

- ▶ Select **Vehicle hotspot**.
- ▶ Select **Connect device to vehicle hotspot**.

### Connecting using WPS PIN generation

- ▶ Select **Connect using WPS PIN generation**.
- ▶ Enter the PIN shown in the multimedia system display on the device to be connected and confirm.

### Connecting using WPS PIN entry

- ▶ Select **Connect using WPS PIN input**.
- ▶ Enter the PIN that is shown on the external device's display on the multimedia system.

### Connecting using a button

- ▶ Select **Connect via WPS PBC**.
- ▶ Press the push button on the device to be connected (see the manufacturer's operating instructions).
- ▶ Select **Continue**.

### Connecting using a security key

- ▶ Select **Connect device to vehicle hotspot**.  
A security key is displayed.
- ▶ Select the vehicle from the device to be connected. It will be shown with the **DIRECT-MB Hotspot 12345** network name.
- ▶ Enter the security key which is shown in the multimedia system display on the device to be connected.
- ▶ Confirm the entry.

### Connecting using NFC

- ▶ Select **Connect via NFC**.

- ▶ Activate NFC on the mobile device (see the manufacturer's operating instructions).
- ▶ Bring the mobile device into the NFC area of the vehicle (→ page 237).
- ▶ Select **Finished**.  
The mobile device is now connected to the multimedia system hotspot via NFC.

### Generating a new security key:

- ▶ Select **Vehicle hotspot**.
- ▶ Select **Generate security key**.  
A connection will be established with the newly created security key.
- ▶ **To save a security key:** select **Save**.  
When a new security key is saved, all existing Wi-Fi connections are then disconnected. If the Wi-Fi connections are being re-established, the new security key must be entered.

## System language

### Notes on the system language

This function allows you to determine the language for the menu displays and the navigation messages. The selected language affects the characters available for entry. The navigation announcements are not available in all languages. If a language is not available, the navigation announcements will be in English.

### Setting the system language

Multimedia system:

- ▶  ▶ **Settings** ▶ **System** ▶ **Language**

- ▶ Set the language.
- ⓘ If you are using Arabic map data, the text information can also be shown in Arabic on the navigation map. To do so, select **العربية** as the language from the language list. Navigation announcements are then also made in Arabic.

## Setting the distance unit

Multimedia system:

- ▶  ▶ **System** ▶ **Units**

- ▶ Select **km** or **mi**.
- ▶ In the multifunction display of the instrument display, switch the **Additional speedometer** display on.



## Data import and data export

### Data import/export function

The following functions are possible:

- transfer data from one system or vehicle to another system or vehicle.
- make a backup copy of your personal data and load it again.
- protect your personal data against unwanted export with PIN protection.

 Please note that the NTFS file system is not supported. The FAT32 file system is recommended.

### Importing/exporting data

 **NOTE** Loss of data due to premature removal

 Do not remove the data storage medium when data is being exported.

Mercedes-Benz is not liable for any loss of data.

#### Requirements:

- The vehicle is stationary.
- The ignition is switched on.
- A USB device is connected .

Multimedia system:

 **System** **System backup**

 Select **Import data** or **Export data**.

#### Importing



 Select a data storage medium.  
A prompt appears asking whether you really wish to overwrite the current data. If data originates from another vehicle, this is recognised during data reading.

The multimedia system is restarted once the data has been imported.

 Current vehicle settings can be edited after the import.

#### Exporting

If PIN protection is activated, your PIN is requested.

-  Enter the four-digit PIN.
-  Select a data storage medium.  
The data is exported. The data export may take several minutes.



 After successful export, the data is saved in the "MyMercedesBackup" directory which can be found on the storage medium.

## Activating/deactivating PIN protection





Multimedia system:

 **Settings** **System** **PIN protection**



### Setting the PIN

-  Select **Set PIN**.
-  Enter a four-digit PIN.
-  Enter the four-digit PIN again.  
If both PINs match, PIN protection is active.

### Changing the PIN

-  Select **Change settings**.
-  Enter the current PIN.
-  Select **Change PIN**.
-  Set a new PIN.

### Activating PIN protection for data export

-  Select **Change settings**.  
Confirm with the PIN.
-  Select **Protect data export**.  
Activate or deactivate the function.

### Unblocking the PIN

-  Consult a Mercedes-Benz service centre and have the PIN protection reset.

## Software update

### Information on software updates

A software update consists of three steps:

- Downloading or copying of the data required for installation
- Installation of the update
- Activation of the update by restarting the system

The multimedia system provides a message when an update is available.

Depending on the source, you can perform various updates:

## Software update

Source of the update	Update type
Internet	Navigation map, system updates, Digital Owner's Manual
External storage medium, e.g. USB flash drive	Navigation maps

Software updates ensure your vehicle's technology is always up-to-date.

In order to constantly improve the quality of our services you will receive future updates for your multimedia system, the Mercedes PRO connect services and your vehicle's communication module. These will conveniently be sent to you via the mobile phone connection in your vehicle and, in many cases, installed automatically. You can monitor the status of your updates at any time via the Mercedes PRO portal and find information about potential innovations.

Your advantages at a glance:

- conveniently receive software updates via the mobile phone network
- the long-term quality and availability of Mercedes PRO connect is guaranteed
- keep your multimedia system and communication module up-to-date

Further information about software updates can be found at <http://www.mercedes.pro>

## Performing a software update

### Requirements:

- **For online updates:** an Internet connection is established (→ page 250).
- **For automatic online updates:** your vehicle has a permanently installed communication module.

Multimedia system:

➔ Settings ➔ System ➔ Software update

### Automatically

- ▶ Activate [Automatic online updates](#).  
The updates will be downloaded and installed automatically.  
The current status of the updates is displayed.

### Manually

- ▶ Deactivate [Automatic online updates](#).
- ▶ Select an update from the list and start the update.

### Activating the software update

- ▶ Restart the system.  
The modifications from the software update will be active.

### Important system updates

Important system updates may be necessary for the security of your multimedia system's data. Please install these updates, or else the security of your multimedia system cannot be ensured.

- ⓘ If automatic software updates are activated, the system updates will be downloaded automatically (→ page 209).

As soon as an update is available for download, a corresponding message appears on the multimedia system display.

You have the following selection options:

- [Download](#)  
The update will be downloaded in the background.
- [Details](#)  
Information about the pending system update is displayed.
- [Later](#)  
The update can be downloaded manually at a later time (→ page 209).

### Deep system updates

Deep system updates access vehicle or system settings and can therefore only be carried out when the vehicle is stationary and the ignition is switched off.

If the download of a deep system update is completed and the update is ready for installation, you will be informed of this after the next ignition cycle, for example.

- ⓘ Park the vehicle safely in a suitable location before starting the installation.

Requirements for the installation:

- The ignition is switched off.
- Notes and warnings have been read and accepted.
- The parking brake is applied.

If all requirements are met, the update will be installed. The multimedia system cannot be oper-

ated while the update is being installed and vehicle functions are restricted.

If errors should occur during the installation, the multimedia system automatically attempts to restore the previous version. If restoration of the previous version is not possible, a symbol appears on the multimedia system display. Please consult a qualified specialist workshop to resolve the problem.

### Reset function (resetting)

Multimedia system:

 >> Settings >> System >> Reset

#### Resetting via the multimedia system

Personal data is deleted, for example:

- Station presets
  - Connected mobile phones
  - Individual user profiles
- i** The guest profile is reset when the settings are restored to the factory settings.

▶ Select **Yes**.

If PIN protection is activated, a prompt appears asking if you also wish to restore this to the factory settings during a reset.

▶ Select **Yes**.

▶ Enter the current PIN.  
The PIN is reset.

Or

▶ Select **No**.

The current PIN stays the same after resetting.



**i** If you have forgotten your PIN, a Mercedes-Benz service centre can deactivate the PIN protection for you.

A prompt appears again asking whether you really wish to reset.

▶ Select **Yes**.

The multimedia system is reset to the factory settings.

#### Resetting using a button

▶ Press both the  and  buttons at the same time until the multimedia system restarts (at least 15 seconds).  
The multimedia system is restarted. No data is deleted during this process.

### Vehicle information

#### Displaying vehicle data

Multimedia system:

 >> Vehicle info

▶ Select **Vehicle**.  
The vehicle data is displayed.

#### Displaying engine data

Multimedia system:

 >> Vehicle info

▶ Select **Engine**.  
The engine data is displayed.

**i** The values for engine output and engine torque may deviate from the nominal values.

Items that can influence this are, for example:

- Engine speed
- Sea level
- Fuel grade
- Outside temperature

#### Calling up the fuel consumption indicator

Multimedia system:

 >> Vehicle info

▶ Select **Consumption**.  
A display with current and average consumption figures is displayed.

## Navigation

### Switching navigation on

Multimedia system:

→ 🏠 ▶▶ Navigation (Navigation)



Example: digital map with menu

- ① To enter a POI, address or three-word address and additional destination entry options
- ② To interrupt route guidance (if route guidance is active)
- ③ To repeat a navigation announcement and switch navigation announcements on/off
- ④ To call up a route menu
  - Route**
    - To select alternative routes
    - To display the route overview
  - To display the route list
  - To select avoidance options
  - To make route settings
- ⑤ To call up the menu settings
  - Traffic**
    - To display traffic reports
    - To show local area messages
    - Report a traffic incident
    - Live Traffic subscription Information
  - Position**
    - To store a position
    - To call up the compass
  - To call up Qibla (available in selected countries)

▶ Alternatively: press the **NAVI** button. The map appears. The current vehicle position is shown. The menu is shown.

▶ **To show:** tap on the multimedia system display.

or

▶ Press the Touch Control.

▶ **To hide:** the menu is hidden automatically.

### Showing/hiding the navigation menu

→ 🏠 ▶▶ Navigation (Navigation)

If no route guidance is active the map and the menu appear.

If route guidance is active the map appears in full-screen mode and the menu is hidden.

## Destination entry

### Notes on destination entry

**⚠ WARNING** Risk of distraction from operating integrated communication equipment while the vehicle is in motion

If you operate communication equipment integrated in the vehicle when driving, you will be distracted from the traffic situation. This could also cause you to lose control of the vehicle.

- ▶ Only operate this equipment when the traffic situation permits.
- ▶ If you cannot be sure of this, stop the vehicle whilst paying attention to road and traffic conditions and operate the equipment with the vehicle stationary.

You must observe the legal requirements for the country in which you are currently driving when operating the multimedia system.

### Entering a POI or address

**⚠ WARNING** Risk of distraction from information systems and communications equipment

If you operate information and communication equipment integrated in the vehicle when

driving, you will be distracted from the traffic situation. This could also cause you to lose control of the vehicle.

- ▶ Only operate this equipment when the traffic situation permits.
- ▶ If you cannot be sure of this, stop the vehicle whilst paying attention to road and traffic conditions and operate the equipment with the vehicle stationary.



You must observe the legal requirements for the country in which you are currently driving when operating the multimedia system.

### Requirements:

- **For the online search:** Mercedes PRO connect is available.
- You have a user account for the Mercedes PRO portal.
- The service is available.
- The service has been activated at a Mercedes-Benz service centre.

Further information can be found at: <http://www.mercedes.pro>

Multimedia system:

➔  ➔ **Navigation** (Navigation) ➔  **Where to?**

### Method 1: on-board search



Destination entry uses the on-board search of the database stored in the multimedia system.

The country in which the vehicle is located is set .

Enter the POI or the address using the keyboard (in the image) or using handwriting recognition ⑥ in ②. The entries can be made in any order.

During destination entry, suggestions are made under ② by the multimedia system. Destination selection takes place in list ③ or with .

The following entries can be made, for example:

- Town, street, house number
- Street, town
- Postcode
- POI name
- POI category, e.g. **Tankstelle** (Filling station)
- Town, POI name
- Telephone number, if this is available for the POI
- Contact name

Example of quick address entry:

- If you are searching for Königsstraße in Stuttgart, for example, you can enter STUT and KÖN.
- If you are searching for a POI in the United Kingdom, for example, you can enter THE SHARD.

If you would like to try out both examples, you may also need to change the country.

As an alternative, voice input ⑧ can also be used.

**To switch to handwriting recognition:** select ⑥.

Write the character on the touchscreen. The letters can be written next to each other or above each other.

**To return to entry using the keyboard:** select .

**To delete an entry:** select ④.  
The characters are deleted individually.

or

If characters have been entered in ②, select  next to the input line.  
The complete entry is deleted.

**To switch to upper-case or lower-case letters:** select ⑪.

**To switch to digits, special characters and symbols:** select ⑩.

With **#+=** you can switch to additional special characters.

**To enter a space:** select ⑦.

**To set the language:** select ⑨.

Select the language.

**i** This function is useful for countries in which several character sets are supported. An example is Russia, which uses Cyrillic and Latin characters.

**To change the country:** select country indicator ①.

Enter the country indicator, e.g. **F** for France. The list is filtered.

Select the country on list ③.  
The destination can be entered.

**To accept a destination:** select the destination in list ③.

If the destination is ambiguous, select the destination in the list.  
The destination address is shown. The route can be calculated.

## Method 2: on-board search

Online search is not available in all countries.

Destination entry uses online map services. If the on-board search finds no suitable destinations or if you change countries, the online search is available.

For the destination you can enter an address, a POI or a three-word address.

Select country indicator ①.

Select the provider for the online service from the countries list.

or

If the on-board search delivers no search results, select **Online search**.

Enter the destination in the input line. The entry order is not relevant, e.g. street and town. Use the functions described for the on-board search.  
The search results are displayed.

Select the destination in the list.  
The detailed view for the route is displayed.



## Selecting previous destinations

### Requirements:

- Previous destinations are stored.
- **For destination suggestions:** you have created a profile (→ page 197).

- The [Allow destination suggestions](#) option is switched on (→ page 198).
- The multimedia system has already gathered sufficient data in order to show destination suggestions.

Multimedia system:

  [Navigation](#) (Navigation) [Where to?](#) [Previous destinations](#)

The following destinations can be selected:

- Previous destinations and routes
- Destination suggestions
- Stored destinations and routes (→ page 221)

▶ Select the destination or route.  
The destination address is shown. The route can be calculated.



ⓘ If you save a previous destination or a suggestion as a favourite (→ page 225), you can select these from the favourites (→ page 216).

### Selecting a POI

#### Requirements:

- **For use of personal POIs:** a USB device is connected with the multimedia system.
- Personal POIs with the GPS Exchange format (.gpx) have been saved in the "PersonalPOI" folder on the USB device.

Multimedia system:

  [Navigation](#) (Navigation) [Where to?](#) [POIs](#)

### Searching using categories (no route guidance)

▶ Select the category.

or

- ▶ Select [ALL CATEGORIES](#).
- ▶ Select the category and the sub-category (if available).
- ▶ When searching, filter with the search field according to categories or within the search results.

The search takes place in the vicinity of the vehicle's current position. The search result are sorted by distance in ascending order.

The POIs show the following information:

- direction of the linear distance to the POI (arrow)

- name of POI
  - linear distance to the POI
- ▶ Select a POI with  or select from the list. The destination address is shown. The route can be calculated.

### Searching using categories (route guidance active)

▶ Select the category.

or

- ▶ Select [ALL CATEGORIES](#).
- ▶ Select the category and the sub-category (if available).
- ▶ When searching, filter with the search field according to categories or within the search results.
- ▶ Select the search positions [In the vicinity](#), [Near destination](#) or [Along the route](#).
- ▶ If there are intermediate destinations for the route and [Near destination](#) has been selected, select the POI in the route overview.
- ▶ Select a POI with  or select from the list. The destination address is shown. The route can be calculated.

### Searching for personal POIs

▶ Select [Personal POIs](#).

▶ Select a category.

▶ If route guidance is active, select a search position [In the vicinity](#), [Near destination](#) or [Along the route](#).

▶ Select a personal POI.

The destination address is shown. The route can be calculated.

or

▶ Enter a search entry into the search field and filter the list.

▶ Select a personal POI.

### Editing personal POI categories

▶ Select a personal POI category from the list .

A menu opens.

▶ **To change a name:** select [Change name](#).

▶ Enter the name.

▶ Select .





▶ **To change a symbol:** select [Change icon](#).

▶ Select a symbol.

- ▶ **To delete a personal POI category:** select **Delete**.
- ▶ Select **Yes**.

### Configuring categories for quick-access

Up to five categories can be configured for quick-access.



- ▶ Select **ALL CATEGORIES**.
- ▶ Select the category and the sub-category (if available).
- ▶ Select  or .
- ▶  adds the category.
- ▶  removes the category.
- ▶ If there are already five categories, select the category which should be replaced.

### Selecting a contact for destination entry

#### Requirements:

- A mobile phone is connected to the multimedia system (→ page 235).

Multimedia system:

 **▶▶ Navigation** (Navigation) **▶▶**  **Where to?** **▶▶** **Contacts**

### Using the contact list

- ▶ Select a contact.  
The contact details are displayed.
- ▶ Select the address.



### Using search entry

- ▶ Enter names or telephone numbers, for example, into the search field.
- ▶ Select .
- ▶ Select the contact.
- ▶ Select the address.  
The destination address is shown. The route can be calculated.



- ▶  Route guidance to a contact address is reliable in the following cases:
  - The contact address is complete.
  - The contact data matches the map data in the digital map.

### Entering geo-coordinates

Multimedia system:



 **▶▶ Navigation** (Navigation) **▶▶**  **Where to?** **▶▶** **Geo-coordinates**

- ▶ Select **Latitude** or **Longitude**.

- ▶ Select geo-coordinates as latitude and longitude coordinates in degrees, minutes and seconds. To do this swipe up or down respectively.  
The map shows the position.
- ▶ Confirm the entry with .
- ▶ **To set the destination:** select the arrow or the arrow with .

### Entering 3 word addresses

Multimedia system:

 **▶▶ Navigation** (Navigation) **▶▶**  **Where to?**

- ▶ Enter the destination address as a 3 word address. Separate each of the words with a full stop.  
The search results are displayed.
- ▶ Select the destination in the list.  
The destination address is shown. The route can be calculated.

- ▶  3 word addresses from what3words are an alternative addressing system for multilingual georeferencing of global locations with a resolution of three metres. Using this grid, locations on the earth's surface are included which do not have a building address such as street and house number, for example.  
The Brandenburg Gate in Berlin has the following language dependent 3 word address, for example:

- German: **tapfer.gebäude.verliehen**
- English: **that.lands.winning**

3 word addresses are unique, easy to remember and suffice for most routine applications.

The bidirektional conversion of 3 word addresses can be carried out here:

- at the website <http://what3words.com>
- in the what3words apps

### Selecting from the map

Multimedia system:

 **▶▶ Navigation** (Navigation)

- ▶ Move the map (→ page 229).
- ▶ When the crosshair marks the destination, press and hold on the control element.  
If a destination is located exactly on the crosshair, the destination address is displayed.





If several destinations are located around the crosshair, a list shows the available roads and POIs.

- ▶ Select the destination in the list. The destination address is shown. The route can be calculated.

### Showing POIs in the vicinity of the map

If several destinations are located around the crosshair, the function is available.

- ▶ Select .
- ▶ Select [POIs in the vicinity](#). The map appears.
- ▶ Swipe left or right on the control element. The previous or next POI is highlighted on the map. The name or the address is shown.
- ▶ Select the POI symbol.
- ▶ **Alternatively, to filter the display according to the POI category:** scroll on the control element.
- ▶ Select the POI category.



 [User defined](#) permits the selection of personal POI symbols (→ page 230).

### Selecting from favourites

#### Requirements:

- Destinations are saved as favourites.  
Save a previous destination or a destination suggestion as a favourite (→ page 225).

Multimedia system:

  [▶▶ Navigation](#) (Navigation) [▶▶ Where to?](#) [▶▶ Aus Favoriten](#) (From favourites)

- ▶ Select a favourite. The destination address is shown. The route can be calculated.

## Route

### Calculating a route

#### Requirements:

- The destination has been entered.
- The destination address is shown.

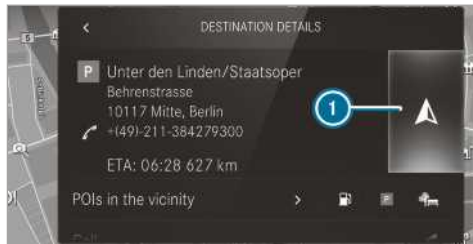

### Route guidance is not active



- ▶ Select . The route to the destination is calculated. The map shows the route. Route guidance then begins.

 If you do not complete this step when driving, the multimedia system automatically calculates the route after about 15 seconds.

### Route guidance is active

- ▶ Select . The arrow shows a . A prompt is shown.
- ▶ Select [Set as intermediate dest.](#) or [Start new route guidance](#).

[Start new route guidance](#): the selected destination address is set as a new destination. The previous destinations and intermediate destinations are deleted. Route guidance to the new destination begins.

[Set as intermediate dest.](#): the selected destination address is set as the next intermediate destination. Route guidance begins.

If there are already four intermediate destinations, the multimedia system asks whether intermediate destination 4 should be deleted. Confirm the prompt with [Yes](#).

### Searching for POIs in the vicinity

 The POI symbols to the right of [POIs in the vicinity](#) show the first three categories for quick-access. You can configure these categories (→ page 214).

- ▶ Select a POI symbol. The search results are displayed.
- ▶ Select a POI. The destination address is shown. The route can be calculated.

or

- ▶ Select [POIs in the vicinity](#) .
- ▶ Search using categories, enter a search entry or search for a personal POI (→ page 214).

- ▶ Select a POI.  
The destination address is shown. The route can be calculated.

### Other menu functions

- ▶ **To save the destination:** select  .
  - ▶ Select an option.  
The following options are available for you:
    - [Save in "Previous destinations"](#)
    - [Save as favourite](#)
    - [Save as "Home"](#)
    - [Save as "Work"](#)



If both addresses are saved and the commuter route is activated, the multimedia system starts route guidance without navigation announcements.
  - ▶ **To call the destination:** if a telephone number is available, select [Call](#).
  - ▶ **To share the destination using NFC or QR code:** select [Share via NFC or QR code](#).
  - ▶ Hold the NFC area of the mobile phone (see manufacturer's operating instructions) on the mat or place the mobile phone on it (→ page 237).
- or
- ▶ Hold the mobile phone near to the multimedia system and scan the QR code.
  - ▶ **To call up an Internet address:** if a web address is available, select [www](#).
  - ▶ **To show on the map:** select [Display on map](#).

### Selecting a route type

#### Requirements:

- **For use of a commuter route:** you have created a profile (→ page 197).
- The [Allow destination suggestions](#) option is switched on (→ page 198).
- The [Activate commuter route](#) option is switched on (→ page 220).
- The multimedia system has gathered sufficient data in order to show destination suggestions.
- Routes have been learned for these destination suggestions.

#### Multimedia system:

  ▶ [Navigation](#) (Navigation) ▶ [Route Icon](#) ▶ [Route](#) ▶ [Route settings](#)

- ▶ Select the route type.  
If no route has been created, the next route is calculated on the basis of the new route type.  
If a route has already been created, the route is calculated on the basis of the new route type.

The following route types are available:

- **Fast route**  
A route with a quick journey time is calculated.
- **Short route**  
A route with a short driving distance is calculated.
- **Eco route**  
An economical route is calculated. The journey time may be somewhat longer than for quicker routes.
- **TRAILER**  
The option is available if a trailer has been coupled with the vehicle.  
A prompt is shown in the multimedia system. Confirm the prompt.  
The route is optimised for trailer operation.

The dynamic route can be switched on or off for the route types named:

- **Automatic**  
The route is calculated with the currently set route type.  
Traffic messages via Live Traffic Information or FM RDS-TMC are taken into account (→ page 225).  
Live Traffic Information and FM RDS-TMC are not available in all countries.
- **After asking**  
A prompt appears when a new route is detected with a shorter journey time based on traffic reports. You can continue to use the current route or use the dynamic route instead (→ page 227).
- **Off**  
No traffic reports are taken into account for the route.

The following additional route settings can be activated or deactivated:

- **Suggest alternative route**  
If the option is switched on (→ page 220), then an alternative route is calculated for each route.
- **Activate commuter route**  
If the option is activated (→ page 220), navigation starts route guidance for the learned routes automatically without voice output.

### Alternative for calling up route types

▶ Select  ▶ **Navigation** (Navigation) ▶  ▶ **Advanced** ▶ **Route settings**.

### Selecting route options

Multimedia system:

  ▶ **Navigation** (Navigation) ▶ **Route Icon** ▶ **Route** ▶ **Avoid options**

### Avoiding areas

▶ Select **Avoid areas** (→ page 231).

### Avoiding motorways, ferries, tunnels, motorail trains, unpaved roads

▶ Switch on the avoid option.

### Using toll roads

- ▶ Select **Use toll roads**.
- ▶ Switch the **Payment by cash or card** and **Electronic billing** options on or off.  
The route takes into account roads that require the payment of a usage fee (toll) corresponding with the payment type selected.

These route options are not available in every country.

The selected route options cannot always be implemented. Therefore, a route may include a ferry, for instance, even though the avoid **Ferries** option is enabled. A message appears and you will hear a corresponding message.

### Using routes requiring a special toll sticker

- ▶ Select **Use vignette roads**.
- ▶ Activate **All**.

or

- ▶ Switch on the countries that should be taken into account.  
The route takes into account roads in the selected countries which require you to pay a time-based fee (vignette). A vignette allows

for the use of a route network for a limited time period.

### Alternative for calling up route options



▶ Select  ▶ **Navigation** (Navigation) ▶  ▶ **Advanced** ▶ **Avoid options**.

### Selecting notifications

#### Requirements:

- **For an audible indication when approaching a personal POI:** the USB device contains personal POIs.
- The USB device is connected with the multimedia system.
- The category in which the personal POI belongs is activated.

Multimedia system:

  ▶ **Navigation** (Navigation) ▶  ▶ **Advanced** ▶ **Announcements**

▶ Select an option or activate or deactivate a notification.

The following options are available:

- **Driving recommendation** option  
The multimedia system issues spoken driving recommendations during route guidance.
- **With street names** option  
The multimedia system announces the names of the roads that will follow the upcoming change of direction.  
This function is not available in all countries and languages.
- **Off** option
- **Announce traffic warnings**  
This function is not available in all countries.

### Audible indication when approaching a personal POI



- ▶ Select **Personal POIs**.
- ▶ Activate a category.  
When approaching a personal POI in this category an audible indication will be issued.

### Showing destination information for the route

#### Requirements:

- A destination is entered.

Multimedia system:

  **▶▶ Navigation** (Navigation) **▶▶ Route Icon** **▶▶ Route**

▶ Select **Route overview**.

When route guidance is active, the destination and intermediate destinations are shown, if these have been entered and not yet been passed.

The route can include up to four intermediate destinations.

▶ Select a destination or an intermediate destination.

The following information is displayed:

- Remaining driving distance
- Time of arrival
- Remaining journey time
- Name, destination address
- Phone number (if available)
- Web address (if available)

### Planning routes

Multimedia system:

  **▶▶ Navigation** (Navigation) **▶▶ Route Icon** **▶▶ Route overview**

▶ Select **Set intermediate destination**.

▶ Enter the intermediate destination as a POI or address, for example (→ page 212).

▶ Select the intermediate destination. After selection of an intermediate destination, the route overview is shown again.

▶ Calculate the route with intermediate destinations (→ page 219)

 If there are already four intermediate destinations, delete an intermediate destination (→ page 219).

### Editing a route with intermediate destinations

#### Requirements:

- A destination is entered.
- For the moving function there must also be at least one intermediate destination.



Multimedia system:

  **▶▶ Navigation** (Navigation) **▶▶ Route Icon** **▶▶ Route** **▶▶ Route overview**

▶ **To change the sequence of destinations:** select  for a destination. A menu opens.

▶ Select **Move**.

 is highlighted.

▶ Move the intermediate destination or the destination with  or  to the desired position.

▶ Tap on .

▶ **To delete a destination:** select  for an intermediate destination or destination.

▶ Select **Delete**.

The destination is deleted.

### Calculating a route with intermediate destinations

#### Requirements:

- The destination and at least one intermediate destination have been entered.

Multimedia system:

  **▶▶ Navigation** (Navigation) **▶▶ Route Icon** **▶▶ Route** **▶▶ Route overview**

▶ Select **Start route guidance**.

or



▶ If the route has been edited, select **To Navigation**.

▶ Confirm the prompt with **Yes**.

The route is calculated. Route guidance begins.

### Displaying the route list

Multimedia system:

  **▶▶ Navigation** (Navigation) **▶▶ Route Icon** **▶▶ Route**

▶ Select **Route list**.

The list shows the route sections. The current vehicle position is marked on the map.

The current vehicle position is shown with the following information:

- The symbol for the current vehicle position is displayed.
- The name of the road on which you are currently driving is shown.

- The road number of the road on which you are currently driving is shown.

The route list is updated during the journey.

- ▶ **To show route sections:** swipe up or down on the control element.

The route section is shown on the map.

### Selecting an alternative route

Multimedia system:

→  ▶▶ **Navigation** (Navigation) ▶▶ **Route Icon**

- ▶ Select **Alternative route**.  
The routes are displayed in accordance with the setting made in the route settings.  
The routes are numbered.
- ▶ Select the alternative route.

### Activating a commuter route

#### Requirements:

- The **Allow destination suggestions** option is switched on (→ page 198).
- The multimedia system has gathered sufficient data in order to show destination suggestions.
- Routes have been learned for these destination suggestions.

Multimedia system:

→  ▶▶ **Navigation** (Navigation) ▶▶ **Route Icon** ▶▶ **Route** ▶▶ **Route settings**

- ▶ Activate **Activate commuter route**.  
The navigation system automatically detects that the vehicle is on a commuter route. It automatically starts a route guidance without voice output.  
For the daily commuter route, traffic incidents on the route are also reported when driving without active route guidance.

### Switching the automatic filling station search on/off

Multimedia system:

→  ▶▶ **Settings** ▶▶ **Fahrzeug** (Vehicle)

- ▶ Activate or deactivate **Filling station search**.  
When the fuel reserve level is reached, and the option is switched on, a prompt appears asking whether you want to start searching for filling stations.

### Starting an automatic filling station search

#### Requirements:

- The automatic filling station search is activated (→ page 220).

#### Driving situation

The fuel level in the fuel tank reaches the reserve fuel level.

The **Fuel tank reserve level Do you want to start the search for filling stations?** message is shown.

- ▶ Select **Yes**.  
The automatic filling station search begins. The available filling stations along the route or in the vicinity of the vehicle's current position are displayed.
- ▶ Select a filling station.  
The address of the filling station is displayed.
- ▶ Calculate the route (→ page 216).  
The filling station is set as the destination or the next intermediate destination.
- ▶ **If there are already four intermediate destinations:** select **Yes** in the prompt.  
The filling station is entered in the route overview. Intermediate destination 4 is deleted. Route guidance begins.

### Starting the automatic service station search

#### Requirements:

- ATTENTION ASSIST and the **Suggest rest area** function are activated (→ page 162).
- There are service stations along the route section ahead.

#### Driving situation

The **Suggest rest area. Do you want to start the rest area search?** message is shown.





- ▶ Select **Yes**.  
The service station search starts. The available service stations along the route or in the vicinity of the vehicle's current position are displayed.
- ▶ Select a service station.  
The service station address is displayed.
- ▶ Calculate the route (→ page 216).  
The service station is set as the destination or the next intermediate destination.
- ▶ **If there are already four intermediate destinations:** select **Yes** in the prompt.  
The service station is entered in the route overview. Intermediate destination 4 is deleted. Route guidance begins.



## Showing a stored route on the map

### Requirements:

- A USB device with stored routes is connected with the multimedia system.
- The route is stored in the "Routes" folder with the GPS Exchange format (.gpx).

Multimedia system:

  **Navigation** (Navigation)  **Where to?**  **Stored routes**





- ▶ Select a route with  or .
- ▶ Select **Display on map**.
- ▶ Move the map (→ page 229).

## Starting a saved route



### Requirements:

- A USB device with stored routes is connected with the multimedia system.
- The route is stored in the "Routes" folder with the GPS Exchange format (.gpx).

Multimedia system:

  **Navigation** (Navigation)  **Where to?**  **Stored routes**

- ▶ Select a route.
- ▶ Select **Start route guidance from the beginning** or **Start route guidance from current location**.  
Route guidance starts.





 The route can be saved with  in the menu (→ page 216).

## Recording a route

### Requirements:

- A USB device is connected with the multimedia system.

Multimedia system:

  **Navigation** (Navigation)  **Where to?**  **Stored routes**





- ▶ **To start recording:** select **Start to record new route**.  
A red recording symbol is shown.  
The route is stored on the USB device.
- ▶ **To stop recording:** select **End recording**.

## Saving a recorded route

### Requirements:

- A USB device is connected with the multimedia system.

Multimedia system:

  **Navigation** (Navigation)  **Where to?**  **Stored routes**





- ▶ Select a route.
- ▶ Select .
- ▶ Select **Store in "Previous destinations"**.  
The route is stored in the "Previous destinations" memory and can be called up from there for route guidance.

## Editing a stored route

### Requirements:

- A USB device with stored routes is connected with the multimedia system (→ page 257).

Multimedia system:

  **Navigation** (Navigation)  **Where to?**  **Stored routes**

- ▶ Select a route with .
- ▶ **To enter a name:** select **Change name**.
- ▶ Enter the name.
- ▶ Select **OK**.

or

- ▶ When the name has been changed, press the  button.
- ▶ Select **Yes**.
- ▶ **To delete a route:** select **Delete**.
- ▶ Select **Yes**.

## Route guidance

### Notes on route guidance

 **WARNING** Risk of distraction from operating integrated communication equipment while the vehicle is in motion

If you operate communication equipment integrated in the vehicle when driving, you will be distracted from the traffic situation. This could also cause you to lose control of the vehicle.

- ▶ Only operate this equipment when the traffic situation permits.
- ▶ If you cannot be sure of this, stop the vehicle whilst paying attention to road and traffic conditions and operate the equipment with the vehicle stationary.

You must observe the legal requirements for the country in which you are currently driving when operating the multimedia system. Route guidance begins once a route has been calculated.

The road and traffic rules and regulations always have priority over multimedia system driving instructions.

Driving instructions are:

- Navigation announcements
- Route guidance displays
- Lane recommendations

If you do not follow the driving instructions or if you leave the calculated route, a new route is calculated automatically.

Driving instructions may differ from the actual road and traffic conditions if:

- The route is diverted
- The direction of a one-way street has been changed

For this reason, you must always observe road and traffic rules and regulations during your journey.

The route may differ from the ideal route due to the following:

- Roadworks
- Incomplete digital map data

### Changing direction overview

Changes of direction are shown in the following displays:

- Detailed image of the junction
  - The display appears when you drive into a junction.
- 3D image
  - The display appears when driving on junction-free, multi-lane roads, for example on motorway exits and motorway interchanges.

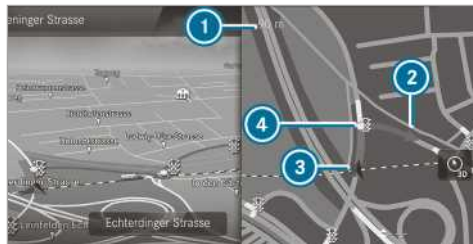

Example: detailed image of the crossing with upcoming changes of direction

- ① Current distance to the change of direction
- ② Changing direction
- ③ Current vehicle position
- ④ Manoeuvre point



Example: 3D image of the upcoming change of direction

- ① Current distance to the change of direction
- ② Changing direction
- ③ Current vehicle position
- ④ Manoeuvre point

There are three phases when changing direction:

- Preparation phase

If there is enough time between the changes of direction, the multimedia system prepares you for the upcoming change of direction. A navigation announcement, e.g. "Prepare to turn right", is issued.

The map appears in full-screen mode.

The status line shows: the direction information or the name of the road which is to be turned into and the distance to the change of direction.

- Announcement phase

The multimedia system announces the upcoming change of direction, e.g. by announcing "Turn right in 100 m".

The display is split into two parts. The map is displayed on the left; on the right, there is a

detailed image of the junction or a 3D image of the upcoming change of direction.

#### • Change-of-direction phase

The multimedia system announces the imminent change of direction, e.g. by announcing "Now turn right".

The display is split into two parts.

The change of direction takes place when the distance to manoeuvre point ④ is shown with 0 m and the symbol for vehicle position ③ has reached manoeuvre point ④.

When the change of direction is complete, the map appears in full-screen mode.

- ① Changes of direction are also shown in the Instrument Display.

### Lane recommendations overview

This display appears for multi-lane roads.

The multimedia system can show lane recommendations if the digital map contains the relevant data.



- ① Recommended lane (white arrow, blue background)
- ② Possible lanes (white arrow)
- ③ Lanes not recommended (grey arrow)

Explanation of the displayed lanes:

- Recommended lane ①  
In this lane, you will be able to complete both the next change of direction and the one after that.
- Possible lane ②  
In this lane, you will only be able to complete the next change of direction.
- Lane not recommended ③  
In this lane, you will not be able to complete the next change of direction without changing lane.

During the change of direction, new lanes may be added.

- ① Lane recommendations can also be shown in the Instrument Display.
- ① Live Traffic Information is not available in all countries.

### Using motorway information

#### Requirement:

- The **Motorway information** option is switched on (→ page 230).



When driving on the motorway, upcoming sections of motorway ① and available service facilities ② are shown. These include car parks, service stations and motorway exits, for example.

- ▶ **To open the display:** select .  
The entries are sorted according to increasing distance from the current vehicle position.
- ▶ Select an entry.
- ▶ Select a service facility from the list.  
The details are displayed. The map shows the position and the driving time to this location.  
The following functions can be used in the detailed display, for example:
  - Search for a POI in the vicinity.
  - Save the destination.
  - Place a call at the destination.
- ▶ Calculate the route (→ page 216).

### Destination reached



Once the destination is reached, you will see the chequered flag. Route guidance is finished.

When an intermediate destination has been reached, you will see the intermediate destination flag with the number of your intermediate destination. After this, route guidance is continued.

### Switching navigation announcements on/off

- ▶ **To switch off:** during a navigation announcement, press the volume control on the steer-



ing wheel or the  /  button on the multimedia system (→ page 196).

The [Spoken driving recommendations have been deactivated.](#) message appears.

or

▶ Show the navigation menu (→ page 211).

▶ Select .

The symbol changes to .

▶ **To activate:** select .

The current navigation announcement is played.



The symbol changes to .

**i** This function can be added and called up from the favourites within the navigation category.

### Switching navigation announcements on/off during a phone call

▶ Press the  button on the steering wheel.

or

▶ Press and hold the  /  button on the multimedia system.

or

▶ Briefly press  in the multimedia system display.

▶ Select [Settings](#).

▶ Select [System](#).

▶ Select [Audio](#).

▶ Select [Navigation and traffic announcements](#).

▶ Switch [Driving recommendations during call](#) on or off.

### Adjusting the volume of navigation announcements

Multimedia system:

 [▶ Settings](#) [▶ System](#) [▶ Audio](#) [▶ Navigation and traffic announcements](#)

▶ Select [Driving recommendation vol..](#)

▶ Set the volume.

### Route guidance is active

▶ Turn the volume control on the multifunction steering wheel during a navigation announcement.



or

▶ Press the volume rocker switch on the multimedia system up or down.

### Switching audio fadeout on/off during navigation announcements

▶ Press the  button on the steering wheel.

or

▶ Press and hold the  /  button on the multimedia system.

or

▶ Briefly press  in the multimedia system display.

▶ Select [Settings](#).

▶ Select [System](#).

▶ Select [Audio](#).

▶ Switch [Audio fadeout](#) on or off.

### Repeating navigation announcements

#### Requirements:

- a route has been created.
- route guidance is active.

Multimedia system:

 [Navigation](#) (Navigation)

▶ Select .

▶ Select .

The current navigation announcement is repeated.

**i** This function can be added and called up from the favourites within the navigation category.

### Cancelling route guidance

#### Requirements:

- A route has been created.
- route guidance is active.

▶ Show the navigation menu.

▶ Select symbol **2** in the navigation menu (→ page 211).

### Overview of route guidance to an off-road destination

An off-road destination is within the digital map. The map contains no roads that lead to the destination.

You can enter geo-coordinates or off-road destinations on the map. Route guidance guides you for as long as possible with navigation announcements and displays on roads that are known to the multimedia system.

Shortly before you reach the last known position on the map, you will hear the "Please follow the direction arrow" announcement, for example. The

display shows a direction arrow and the linear distance to the destination.

### Overview of route guidance from an off-road location to a destination

In an off-road position, the current vehicle position is located within the digital map on roads that are not available.

These displays appear when route guidance begins:

- A message appears that the road is not on the map.
- A direction arrow showing the linear direction to the POI.

When the vehicle is back on a road known to the multimedia system, route guidance continues as normal.

### Overview of off-road status during route guidance

Due to roadworks, for example, there may be differences between the data on the digital map and the actual course of the road. In such cases, the multimedia system will temporarily be unable to locate the vehicle's current position on the digital map. The vehicle is off-road.

When the vehicle is off-road, the following displays are shown:



- A message appears that the road is not on the map.
- A direction arrow showing the linear direction to the POI.

When the vehicle is back on a road known to the multimedia system, route guidance continues as normal.

## Destination

### Saving the current vehicle position

Multimedia system:

 [Navigation](#) (Navigation)  [Route Icon](#)  [Position](#)

- ▶ Select [Store position](#).  
The current vehicle position is saved to the "Previous destinations" memory.



### Editing the previous destinations

#### Requirements:

- For editing destination suggestions: the [Allow destination suggestions](#) option is activated (→ page 198).

- The multimedia system has gathered sufficient data in order to show destination suggestions.

Multimedia system:

 [Navigation](#) (Navigation)  [Where to?](#)  [Previous destinations](#)

The following destinations can be edited:

- Previous destinations
- Destination suggestions



- ▶ **To no longer display a destination suggestion:** select  for a destination suggestion.
- ▶ Select [Do not suggest](#).

### Saving the last destination as a favourite

 After saving, the destination can be called up via the favourites (→ page 199).

- ▶ Select  for a destination.
- ▶ Select [Save as favourite](#).
- ▶ **To save as a favourite:** select [Save as favourite](#).
- ▶ **To save as "Home" address:** select [Save as "Home"](#).
- ▶ **To save as "Work" address:** select [Save as "Work"](#).

### Deleting a previous destination

- ▶ **To delete a destination:** select  for the previous destination.
- ▶ Select [Delete](#).
- ▶ Select [Yes](#).
- ▶ **To delete all destinations:** select .
- ▶ Select [Delete all](#).
- ▶ Select [Yes](#).

## Route guidance with current traffic reports

### Traffic information overview

 The services are not available in every country.

Traffic reports can be received with the following services:

- Live Traffic Information
- FM RDS-TMC

It is not possible to use both services simultaneously.

Live Traffic Information or FM RDS-TMC is displayed with a symbol.

- ❶ Hazard warnings can be received using the Car-to-X service.
- ❷ There may be differences between the traffic reports received and the actual road and traffic conditions.

Important information on Live Traffic Information:

- Current traffic reports are received via the Internet connection (for selected countries).
- The traffic situation is updated at short, regular intervals.
- In selected countries, the subscription service is available free of charge for a period of three years from the manufacturing date. Subscription information shows the status (→ page 226).

Registering Live Traffic Information

- The service must be registered at a Mercedes-Benz service centre (→ page 226):  
This secures the free-of-charge period of three years.

Information on the vehicle's position is regularly sent to Daimler AG. The data is immediately rendered anonymous by Daimler AG and forwarded to the traffic data provider. Using this data, traffic reports relevant to the vehicle's position are sent to the vehicle. The vehicle acts as a sensor for the flow of traffic and helps to improve the quality of the traffic reports.

If you do not wish to transmit your vehicle position, have this service deactivated at a Mercedes-Benz service centre.

Useful information on FM RDS-TMC:

- A FM RDS-TMC radio station broadcasts traffic reports alongside the radio programme.
- FM RDS-TMC is not available in all countries.

### Displaying subscription information

#### Requirements:

- The vehicle is equipped with Live Traffic Information.

Multimedia system:

→  **Navigation** (Navigation) → **Route Icon** → **Traffic**

▶ **To display manually:** select **Live Traffic Subscription Info**.

Depending on the status, one of the following messages appears:

- the logo of the traffic data provider is shown. The subscription is valid.
- the logo of the traffic data provider is shown. The subscription has expired.

The subscription expiry date is automatically displayed:

- one month before the expiry date
  - one week before the expiry date
  - on the expiry date
- ❶ When the subscription has expired then in selected countries FM RDS-TMC is available. The subscription can be extended (→ page 226).

### Extending a subscription

#### Requirements:

- The vehicle is equipped with Live Traffic Information.
  - You have a user account on the Mercedes PRO website.
- ▶ Call up the Mercedes PRO website.
  - ▶ Call up the Mercedes PRO user account.
  - ▶ Switch to the Mercedes PRO connect online store via the linked vehicle.
  - ▶ Select the Live Traffic Information service.
  - ▶ Select the renewal period.
  - ▶ Add the product to the shopping basket.
  - ▶ Accept the general and specific terms of use. Live Traffic Information remains activated for the selected extension period. Activation begins on the date of extension.

### Registering Live Traffic Information

#### Requirements:

- The vehicle is equipped with Live Traffic Information.
- You have a user account on the Mercedes PRO website.

The Live Traffic Information service must be registered. This secures the full period of three years.

- ▶ Create a user account at Mercedes PRO at: <http://www.mercedes.pro>. A valid email address is required for this.
- ▶ Register the vehicle using the vehicle identification number (VIN).
- ▶ **Registration in the Mercedes-Benz service centre:** have the connection carried out in a Mercedes-Benz service centre.

## Showing traffic information

### Requirements:

- The [Traffic](#) display is switched on (→ page 227).
- The following traffic displays are switched on (→ page 227):

[Traffic incidents](#)

[Freier Verkehrsfluss](#) (Free traffic flow)

[Delay](#)

Multimedia system:



- ▶ Select [Navigation](#) (Navigation).

The map shows the following traffic information:

- traffic incidents, for example:
  - roadworks
  - road blocks
  - warning messages

When route guidance is active, the symbols for traffic incidents will be shown in colour on the route. Off the route they are grey.

- warning message symbols:
  - symbol
  - road safety notes, e.g. when approaching the end of a traffic jam

If the vehicle approaches a danger area on the route, a warning message is displayed on the map. A warning message may also be issued.
- traffic flow information:
  - traffic jam (red line)
  - slow-moving traffic (orange line)
  - heavy traffic (yellow line)
  - free-flowing traffic (green line)

- display for traffic delays on the route lasting at least one minute

## Accepting a detour recommendation after a prompt

### Requirements:

- [After asking](#) is activated (→ page 217).
- route guidance is active.
- there are traffic reports for the current route.

If a new route with a shorter driving time is determined, the current and new routes will be shown.

The notification is shown in another application. Confirm the notification.

▶ **To accept the new route:** select [Accept recommended detour](#).

▶ **To maintain the current route:** select [Keep to current route](#).

## Showing local area messages

Multimedia system:

▶ [Navigation](#) (Navigation) ▶ [Route Icon](#) ▶ [Traffic](#)

▶ Select [Area messages](#).

Local area messages are shown, for example fog or heavy rain.

▶ Select a local area message.  
The details are displayed.

## Switching the traffic information display on

Multimedia system:

▶ [Navigation](#) (Navigation) ▶

▶ Activate [Traffic](#).

## Activating Incidents, Free Flow and Delay

▶ Select [Advanced](#).

▶ In the [TRAFFIC](#) category, activate the [Traffic incidents](#), [Freier Verkehrsfluss](#) (Free traffic flow) and [Delay](#) entries.

If traffic information has been received, then traffic incidents such as roadworks, road blocks, local area reports (e.g. fog) and warning messages are displayed.



The traffic delay is displayed for the current route. Traffic delays lasting one minute or longer are taken into consideration.

## Displaying traffic incidents

### Requirements:

- The [Traffic incidents](#) display is switched on (→ page 227).

Multimedia system:

  **Navigation** (Navigation)  **Route Icon**  **Traffic**

▶ Select **Traffic messages 3**.

The list is sorted according to distance and shows the traffic incidents received.

The traffic incidents on the route are shown first.

A traffic incident shows the following information:

- Street number or street name
- Traffic incident symbol
- Cause
- Distance from current vehicle position

▶ Select a traffic incident.

The detailed information, for example the route section, is shown.

### Showing traffic incidents in the vicinity of the map

▶ Select a traffic incident symbol on the map. The details about the traffic incident are displayed.

▶ Select .



▶ Select **Traffic incidents in vicinity**.

The map shows the traffic incident symbols in the vicinity.

Traffic incident information is displayed in the status line:

- Traffic incident symbol
- Cause of the traffic incident, e.g. construction work
- Warning message (highlighted red)

▶ **To select a traffic incident symbol:** select

 or .

▶ **To select the map section:** tap on the multimedia system display.

or

▶ Press the Touch Control.

▶ Move the map.

▶ **To return to the navigation map:** tap on

.

or

▶ Press the  button on the Touch Control.

## Car-to-X-Communication

### Overview of Car-to-X-Communication

Requirements:

- The vehicle is equipped with a multimedia system featuring navigation and a communication module with an activated, integrated SIM card.
- You have a user account with Mercedes PRO.
- The Car-to-X-Communication service is activated.

 Car-to-X-Communication is available in selected countries.

The communication module automatically establishes an Internet connection once the ignition is switched on. If there are any hazard warnings, they will be provided shortly thereafter. Depending on the mobile phone connection, the provision takes place from within a second up to about a minute.

- Hazards are recognised automatically by the vehicle or may be reported by the driver. These are then sent to vehicles with Car-to-X-Communication in the immediate vicinity.
- Current details relating to hazard spots near the vehicle's current position are received. This gives you sufficient time to adapt your driving style to the traffic conditions.

The use of Car-to-X-Communication requires the regular transmission of vehicle data to Daimler AG. The data is then immediately pseudonymised by Daimler AG. The vehicle data is deleted after an appropriate amount of time has elapsed (several weeks) and is not stored permanently.

 Data which serves as identification is replaced during the pseudonymisation process. In this way, your identity is protected against access by unauthorised third parties.

### Displaying hazard warnings

Multimedia system:

▶ Select **Navigation** (Navigation).

If hazard warnings are available these will be shown on the map.

The following hazard warnings are shown on the map:

- broken-down vehicles
- accidents
- hazardous weather

- general hazards
- hazard warning lights, if activated
- mobile roadworks

The display is not available in all countries and regions.

In the Federal Republic of Germany the display is currently available in the Federal State of Hesse.

- ① If the vehicle is approaching a hazard spot with a vehicle speed of at least 60 km/h, the voice output "Traffic incident ahead" is issued.  
The voice output is not issued for hazardous weather.

### Sending hazard warnings

Automatically detected hazard warnings are sent by the vehicle.

- ▶ **To send hazard warnings yourself:** select  ▶ **Navigation** (Navigation) ▶ **Route Icon** ▶ **Traffic**.
- ▶ Select **Report traffic incident**.  
A prompt is shown.
- ▶ Select **Yes**.  
The **Thank you for supporting accident prevention** message appears.

## Map and compass

### Setting the map scale

Multimedia system:

- ▶  ▶ **Navigation** (Navigation)

#### Zooming in

- ▶ When the map is shown, tap twice quickly with one finger on the multimedia system display.

or

- ▶ Move two fingers apart on the multimedia system display.

#### Zooming out

- ▶ Tap with two fingers on the multimedia system display.

or

- ▶ Move two fingers together on the multimedia system display.

- ① You can set the unit of measurement of the map scale (→ page 207).

### Moving the map

Multimedia system:

- ▶  ▶ **Navigation** (Navigation)



- ▶ When the map is displayed move a finger in any direction on the multimedia system display. The map moves in the opposite direction under crosshair ①.

When the map has been moved the following information appears in the status line, for example:

- The distance from vehicle's current position ② is shown.
- Information about the current map position is shown, e.g. the name of the road.

The following functions can be used:

- Select a destination on the map (→ page 215).
- Select a POI (→ page 214).
- Show traffic incidents on the map (→ page 227).

This function is not available in all countries.

- ▶ **To reset the map to the current position of the vehicle:** tap on symbol ③.

### Rotating the map

- ▶ With two fingers, rotate anti-clockwise or clockwise on the multimedia system display.

### Selecting the map orientation

Multimedia system:

- ▶  ▶ **Navigation** (Navigation) ▶  ▶ **Advanced**

- ▶ Swipe up until **MAP ORIENTATION** is shown.
- ▶ Select the map orientation. The ● dot indicates the current setting.
  - **2D north up:** the 2D map view is displayed so that north is always at the top.

- **2D heading up:** the 2D map view is aligned to the direction of travel.
- **3D:** the 3D map view is aligned to the direction of travel.

### Alternative using quick-access

- ▶ Repeatedly tap or press on the  compass symbol on the map. The view changes in the sequence **3D**, **2D heading up** to **2D north up**. If the map is moved, it can switch between **3D** and **2D north up**.

### Selecting POI symbols for the map display

Multimedia system:

- ▶  ▶ **Navigation** (Navigation) ▶  ▶ **Advanced**



POIs include filling stations and hotels, for example. These can be displayed as symbols on the map. Not all POIs are available everywhere.

Personal POIs are destinations which you have saved on a USB device, for example.

- ▶  The display of POI symbols on the map can be activated or deactivated as a favourite.

- ▶ Activate **POI symbols**.



### Configuring the map display

- ▶ Select  **POI symbols**.
- ▶ Activate or deactivate the categories for quick-access.
- ▶ Select  **All categories**.
- ▶ Activate or deactivate **Show all**.

or

- ▶ Select the categories and sub-categories (if available) .
- ▶ Switch the categories and sub-categories (if available) on or off. The POI symbols for the selected categories are displayed.

### Configuring personal POIs

- ▶ Select **Personal POIs** .
- ▶ Activate or deactivate the categories. When the category is switched on and the vehicle approaches a personal POI in this category, a visual and audible notification can be issued.
- ▶ **To set a notification when approaching:** select a category or a personal POI . A menu opens.
- ▶ Switch **Visual** and **Audible** on or off.

### Resetting personal POIs

- ▶ Select .
- ▶ Select **Reset**. The settings are reset to the standard settings.

### Selecting text information

Multimedia system:

- ▶  ▶ **Navigation** (Navigation) ▶  ▶ **Advanced**

- ▶ Scroll up until **TEXT INFORMATION** is shown.
- ▶ Select **Current street**, **Geo-coordinates** or **None**. **Current street** shows the street you are currently driving on at the bottom of the display.

When the map is moved, the street name, the POI name or the area name appears under the crosshair.

**Geo-coordinates** displays the following information:

- Longitude and latitude
- Elevation  
The elevation shown may deviate from the actual elevation.
- Number of satellites from which a signal can be received  
When the map is moved, this information does not appear.

**None** switches the display off.

### Switching motorway information on/off

Multimedia system:

- ▶  ▶ **Navigation** (Navigation) ▶ 

- ▶ Switch **Motorway information** on or off. When the option is switched on, additional information about the motorway facilities ahead appears during the motorway journey. These include car parks, service stations and motorway exits, for example.

### Displaying the next intersecting street

#### Requirements:

- Route guidance is not active.

Multimedia system:

- ▶  ▶ **Navigation** (Navigation) ▶  ▶ **Advanced**

- ▶ Swipe up until **TEXT INFORMATION** is shown.

- ▶ Activate [Next intersecting street](#).  
If the function is switched on and the journey continues without route guidance, the name of the next intersecting street will be displayed at the upper edge of the display.

### Displaying the map version

Multimedia system:

→  ▶ [Navigation](#) (Navigation) ▶  ▶ [Advanced](#)

- ▶ Swipe upwards and select [Map version](#).
- ⓘ Information about new versions of the digital map can be obtained from a Mercedes-Benz service centre.

### Avoiding an area

You can define areas along a route that you would like to avoid.

Motorways or multi-lane expressways, which are routed through an area to be avoided are taken into account for the route.

### Avoiding a new area

Multimedia system:

→  ▶ [Navigation](#) (Navigation) ▶ [Route Icon](#) ▶ [Avoid options](#) ▶ [Avoid areas](#)

- ▶ Select [Avoid new area](#).
- ▶ **Method 1:** select [Using map](#).
- ▶ Move the map (→ page 229).
- ▶ **Method 2:** select [Via address entry](#).
- ▶ Enter the address (→ page 212).
- ▶ Select the destination in the list or accept with .  
The map appears.
- ▶ **To show an area:** tap or press on the control element.  
A red rectangle appears. This designates the area that should be avoided.
- ▶ **To change the map scale:** move two fingers together or apart on the multimedia system display.  
The map is zoomed in or out.
- ▶ **To set an area:** press on the central control element.  
The area is entered into the list.

### Changing an area

Multimedia system:

→  ▶ [Navigation](#) (Navigation) ▶ [Route Icon](#) ▶ [Avoid options](#) ▶ [Avoid areas](#)

- ▶ Select an area in the list.
- ▶ Select [Edit](#).

### Moving the area on the map

- ▶ Swipe in any direction on the central control element.

### Changing the size of the area

- ▶ Press on the central control element.
- ▶ Swipe up or down on the central control element.
- ▶ Press on the central control element.

### Taking the area for the route into account

- ▶ Select an area in the list.
- ▶ Activate [Avoid area](#).  
If route guidance is active, a new route is calculated.  
If there is no route yet, the setting is carried over to the next route guidance.  
The route can include an area that is to be avoided in the following cases:
  - the destination is located in an area that is to be avoided
  - there is no sensible alternative route

### Deleting one or all areas

Multimedia system:

→  ▶ [Navigation](#) (Navigation) ▶ [Route Icon](#) ▶ [Avoid options](#) ▶ [Avoid areas](#)

### Deleting an area

- ▶ Select an area in the list.
- ▶ Select [Delete](#).
- ▶ Confirm the prompt with [Yes](#).

### Deleting all areas

- ▶ Select .
- ▶ Select [Delete all](#).
- ▶ Confirm the prompt with [Yes](#).



## Updating the map data

### Updating at the Mercedes-Benz service centre

The digital maps generated by the map software become outdated in the same way as conventional road maps. Optimal route guidance can only be provided by the navigation system in conjunction with the most up-to-date map data. Information about new versions of the digital map can be obtained from a Mercedes-Benz service centre.

You can receive updates to the digital map there.

### Online map update

The online map update service from Mercedes PRO connect can be used to update the map data.

This service is not available in all countries.

You can use the following update options:

- for one region (automatic map update)
  - For automatic map updates the [Automatic online updates](#) system setting must be activated (→ page 209).
- for several or all regions (manual map update)

The map data will first be downloaded onto a storage medium and then updated on the multimedia system.

Further information on the online map update <http://www.mercedes.pro>.

### Overview of map data

Your vehicle is supplied with map data at the factory. Depending on the country, map data for your region is either pre-installed or the map data is supplied on a data storage medium.

If the map data on your vehicle has been installed at the factory and you wish to reinstall it, you do not need to enter the activation code.

For map data that you have purchased in the form of a data storage medium, you must enter the accompanying activation code.

- ① If you save the map data on a data storage medium with the online map update service, no entry is required. The activation code is stored on the data storage medium during the downloading process.

Observe the following when entering the activation code:

- The activation code can be used for one vehicle

- The activation code is not transferable
- The activation code has six digits

In the event of the following problems, please contact a Mercedes-Benz service centre:

- The multimedia system does not accept the activation code
- You have lost the activation code

### Displaying the compass

Multimedia system:

→  ► [Navigation](#) (Navigation) ► [Route Icon](#) ► [Position](#)

► Select [Compass](#).

The compass display shows the following information:

- the current direction of travel with bearing (360° format) and compass direction
- longitude and latitude coordinates in degrees, minutes and seconds
- height (rounded)
- number of GPS satellites from which a signal can be received

### Displaying Qibla

Multimedia system:

→  ► [Navigation](#) (Navigation) ► [Route Icon](#) ► [Position](#)

This function is not available in all countries.

► Select [Qibla](#).

The arrow on the compass shows the direction to Mecca in relation to the current direction of travel.

The number of satellites received is shown.

### Setting the map scale automatically

Multimedia system:

→  ► [Navigation](#) (Navigation) ►  ► [Advanced](#)

The map scale is set automatically depending on your driving speed and the type of road.

► Activate [Auto zoom](#).

- ① The automatically selected map scale can be changed manually. After a few seconds, this is automatically reset.

## Displaying the satellite map

Multimedia system:

  **Navigation** (Navigation)  **Advanced**

- ▶ Switch **Satellite map** on or off.  
If the option is activated, satellite maps are displayed in map scales from 2 km.  
If the option is deactivated, satellite maps are not displayed in map scales from 2 km to 20 km.  
The satellite maps for these map scales are not available in all countries.

## Displaying weather information and other map contents

### Requirements:

- You have a user account with Mercedes PRO connect.
- The service is available.
- The service has been activated.

Further information can be found at: <http://www.mercedes.pro>

Multimedia system:

  **Navigation** (Navigation)  **Advanced**

- ▶ Select **Online map contents**.  
The available services are displayed. The services are provided by Mercedes PRO connect.
- ▶ Switch on a service, e.g. **Weather**.  
Current weather information is displayed on the navigation map, e.g. temperature or cloud cover. The service information, e.g. weather symbols, is not shown in all map scales.  
Further information about available services and about displaying information in the map scales: <http://www.mercedes.pro>  
The services are not available in every country.

## Parking service

### Notes for the parking service

**⚠ WARNING** Risk of accident and injury due to not observing the maximum permitted access height

If the vehicle height exceeds the maximum permitted access height for multi-storey car

parks and underground car parks, the vehicle roof as well as other vehicle parts could be damaged.

There is a risk of injury to the vehicle occupants.

- ▶ Before driving into a multi-storey car park or underground car park observe the locally signposted access height.
- ▶ If the vehicle height, including any additional equipment, exceeds the maximum permitted access height, do not drive into the multi-storey car park or underground car park.

## Selecting parking options

### Requirements:

- The navigation services option is available, subscribed to and activated in the Mercedes PRO portal.

The parking service is within the scope of the navigation service.

- **Parking** is activated (→ page 234).

Multimedia system:

  **Navigation** (Navigation)

- ▶ Tap on **[P]** in the map.
- ▶ Select a parking option.  
The following information is displayed (if available):
  - Destination address, distance from current vehicle position and arrival time
  - Information on the multi-storey car park / car park  
For example, opening times, parking charges, current occupancy, maximum parking time, **maximum access height**.  
The maximum access height shown by the parking service does not replace the need for observation of the actual circumstances.
  - Available payment options (Mercedes pay, coins, bank notes, cards)
  - Details on parking tariffs
  - Number of available parking spaces
  - Payment method (e.g. at the parking machine)
  - Services/facilities at the parking option
  - Telephone number
- ▶ Calculate the route (→ page 216).



## Bluetooth® profile overview

Bluetooth® profile of the mobile phone	Function
BPAP (Phone Book Access Profile)	Contacts are automatically displayed in the multimedia system
MAP (Message Access Profile)	Message functions can be used

## Telephony operating modes overview

The following telephone operating modes are available:

- One mobile phone is connected to the multimedia system via Bluetooth® (→ page 235).
- Two mobile phones are connected with the multimedia system via Bluetooth® (two phone mode).
  - You can use all the functions of the multimedia system with the mobile phone in the foreground.
  - You can receive incoming calls and messages with the mobile phone in the background.

You can interchange the mobile phone in the foreground and background any time (→ page 236).

- i** Irrespective of this, Bluetooth® audio functionality can be used with any mobile phone (→ page 258).

## Notes on telephony

**⚠ WARNING** Risk of distraction from operating integrated communication equipment while the vehicle is in motion

If you operate communication equipment integrated in the vehicle when driving, you will be distracted from the traffic situation. This could also cause you to lose control of the vehicle.

- ▶ Only operate this equipment when the traffic situation permits.
- ▶ If you cannot be sure of this, stop the vehicle whilst paying attention to road and traffic conditions and operate the equipment with the vehicle stationary.

**⚠ WARNING** Risk of distraction from operating mobile communication equipment while the vehicle is in motion

If you operate mobile communication equipment when driving, you will be distracted from the traffic situation. This could also cause you to lose control of the vehicle.

- ▶ Only operate this equipment when the vehicle is stationary.

You must observe the legal requirements for the country in which you are currently driving when operating mobile communication equipment in the vehicle.

Further information can be obtained from a Mercedes-Benz service centre or at: <http://www.mercedes-benz.com/connect>.

## Information on telephony

The following situations can lead to the call being disconnected while the vehicle is in motion:

- there is insufficient network coverage in the area
- you move from one transmission/reception station to another and no communication channels are free
- the SIM card used is not compatible with the network available
- a mobile phone with "Twincard" is logged into the network with the second SIM card at the same time

The multimedia system supports calls in HD Voice® for improved speech quality. A requirement for this is that the mobile phone and the mobile phone network provider of the person you are calling support HD Voice®.

Depending on the quality of the connection, the voice quality may fluctuate.

## Connecting a mobile phone

### Requirements:

- Bluetooth® is activated on the mobile phone (see the manufacturer's operating instructions).
- Bluetooth® is activated on the multimedia system (→ page 205).

Multimedia system:



### Searching for a mobile phone

- ▶ Select [Connect new device](#).

### Connecting a mobile phone (authorisation using Secure Simple Pairing)

- ▶ Select a mobile phone.
  - ▶ A code is displayed in the multimedia system and on the mobile phone.
  - ▶ **If the codes match:** confirm the code on the mobile phone.
- i** For older mobile phone models, enter a one to sixteen-digit number code on the mobile phone and on the multimedia system for authorisation.
- i** Up to 15 mobile phones can be authorised on the multimedia system. Authorised mobile phones are reconnected automatically.
- i** The connected mobile phone can also be used as Bluetooth® audio equipment (→ page 258).

### Connecting a second mobile phone (two phone mode)

#### Requirements:

- At least one mobile phone is already connected to the multimedia system via Bluetooth®.

Multimedia system:



- ▶ Select [Connect new device](#).
- ▶ Select the mobile phone.
- ▶ Select [With <Mobile phone>](#). The selected mobile phone is connected to the multimedia system.

### Functions of the mobile phone in two phone mode

#### Functions overview

Functions of the mobile phone in the foreground	Functions of the mobile phone in the background
Full range of functions	Incoming calls and messages

### Interchanging mobile phones (two phone mode)

Multimedia system:



You can also interchange the two connected mobile phones in the following submenus:

- Contacts
- Call list
- Messages

After interchanging the mobile phones in one of the submenus, the mobile phone in the foreground is replaced by the mobile phone in the background.

### Changing the function of a mobile phone

Multimedia system:



#### Activating a function

- ▶ Select a grey symbol in the line of a mobile phone. The corresponding function is activated.

#### Deactivating a function

- ▶ **A function is active:** select the coloured symbol in the line of a mobile phone. The mobile phone is disconnected from the multimedia system.
- ▶ **Several functions are active:** select a coloured symbol in the line of a mobile phone. The corresponding function is deactivated.

### Replacing mobile phones

Multimedia system:



- ▶ **No authorised mobile phone available:** select [Connect new device](#).
- ▶ Select a mobile phone.
- ▶ **Newly authorised mobile phone:** confirm the number code on the mobile phone.

### Using in single telephone mode

- ▶ Select [Only Device\\_name](#). A newly authorised mobile phone is connected in single telephone mode. If the mobile phone has already been authorised and connected in single telephone mode,

it is connected again in single telephone mode.

If a mobile phone has already been authorised and connected in two phone mode with another mobile phone, it will be connected in future in single telephone mode.

### Using in two phone mode

- ▶ Select **With <Mobile phone>**.

A newly authorised mobile phone is connected with the selected mobile phone in two phone mode.

If the mobile phone has already been authorised and connected in single telephone mode, it will be connected in future with the selected mobile phone in two phone mode.

If the mobile phone was previously connected with another mobile phone, this connection is cancelled.

### Disconnecting/deauthorising a mobile phone

Multimedia system:



- ▶ Select **[...]** in the line of the mobile phone.
- ▶ **To disconnect:** select **Disconnect**.  
If applicable, the mobile phone will be automatically reconnected when the vehicle is next started.
- ▶ **To deauthorise:** select **Deauthorise**.

### Information on Near Field Communication (NFC)

NFC enables short-range wireless data transfer or (re)connection of a mobile phone with the multimedia system.

The following functions are available without having authorised a mobile phone:

- Transferring a URL or a contact to be viewed in the multimedia system (see the manufacturer's operating instructions).
- Setting up the vehicle's Wi-Fi access data via the system settings (→ page 207).

Further information can be obtained at: <http://www.mercedes-benz.com/connect>

### Using the mobile phone with Near Field Communication (NFC)

#### Requirements:

- NFC is activated on the mobile phone (see the manufacturer's operating instructions)

- The mobile phone's screen is switched on and unlocked (see the manufacturer's operating instructions)

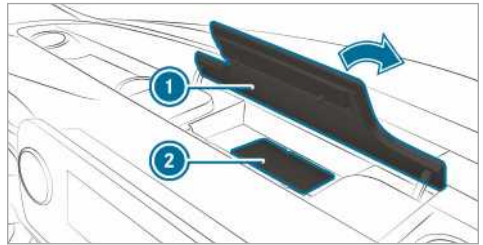

- ▶ Open the flap of stowage compartment ① above the multimedia system display.
- ▶ **To connect a mobile phone:** hold the NFC area of the mobile phone (see manufacturer's operating instructions) on mat ② or place the mobile phone on it.
- ▶ Follow the additional prompts on the multimedia system display to connect the mobile phone. Connect the mobile phone in single telephone mode (→ page 235). Connect the mobile phone in two phone mode (→ page 236).
- ▶ **To replace a mobile phone:** hold the NFC area of the mobile phone (see manufacturer's operating instructions) on the mat or place the mobile phone on it.
- ▶ Follow the additional prompts on the multimedia system display to replace the mobile phone in one or two phone mode (→ page 236).
- ▶ If required, confirm the prompts on your mobile phone (see the manufacturer's operating instructions).

Further information can be found at: <http://www.mercedes-benz.com/connect>

### Setting the reception and transmission volume

#### Requirements:

- A mobile phone is connected (→ page 235).

Multimedia system:



This function ensures optimal language quality.

- ▶ Select **Reception volume** and **Transmission volume**.
- ▶ Set the volume.

Further information on the recommended reception and transmission volume: <http://www.mercedes-benz.com/connect>

### Setting the ringtone

Multimedia system:



Select **Ringtones**.

Set the ringtone.

- ⓘ If the mobile phone supports the transfer of the ringtone, you will hear the ringtone of the mobile phone instead of that of the vehicle.

### Starting/stopping mobile phone voice recognition



#### Requirements:

- The mobile phone in the foreground is connected with the multimedia system (→ page 235).

#### Starting mobile phone voice recognition

- ▶ Press and hold the  button on the multi-function steering wheel for more than one second.  
You can use mobile phone voice recognition.

#### Stopping mobile phone voice recognition

- ▶ Press the  or  button on the multi-function steering wheel.
- ⓘ If a mobile phone is connected via Smartphone Integration, the voice recognition of this mobile phone is started or stopped.



## Calls

### Telephone operation

Multimedia system:



#### Making a call by entering the numbers

- ▶ Select .
  - ▶ Enter a number.
  - ▶ Select .
- The call is made.

#### Accepting a call

- ▶ Select  **Accept**.

### Rejecting a call





- ▶ Select  **Reject**.

### Ending a call

- ▶ Select .

### Activating functions during a call

The following functions are available during a call:

- ▶  **End call**
- ▶  **Microphone off**
- ▶  **Numerical keypad** (show to send DTMF tones)
- ▶  **Add call**
- ▶  **Transfer to phone** (an active call in hands-free mode is transferred over to the telephone)

- ▶ Select a function.

### Putting an active call on hold

- ▶ Tap on the contact or the call.  
The call will be put on hold.
- ⓘ The call on hold can be ended any time or re-activated by tapping again.

### Conducting calls with several participants

#### Requirements:

- There is an active call (→ page 238).
- Another call is being made.

#### Switching between calls

- ▶ Select the contact.  
The selected call is active. The other call is on hold.

#### Activating a call on hold

- ▶ Select the contact of the call on hold.

### Conducting a conference call

- ▶ Select  **Create conferen. call**.  
The new participant is included in the conference call.

## Ending an active call

Select  End call.

**i** On some mobile phones, the call on hold is activated as soon as the active call is ended.

## Accepting/rejecting a waiting call

### Requirements:

- There is an active call (→ page 238).

If you receive a call while already in a call, a message is displayed.

Depending on the mobile phone and network operator you will hear a call-waiting sound.

In addition, in two phone mode you will hear an acoustic signal when the call goes through to the other (not yet active) mobile phone.

Select  Accept.  
The incoming call is active.

If only one mobile phone is connected with the multimedia system, the previous call will be put on hold.

If during a call you accept a call with the other mobile phone when in two phone mode then the existing call is ended.

Select  Reject.

**i** This function and behaviour depends on your mobile phone network provider and the mobile phone (see the manufacturer's operating instructions).

## Contacts

### Information about the contacts menu

The contacts menu contains all contacts from existing data sources, e.g. mobile phone or memory card.

Depending on the data source, you have the following number of contacts:

- Permanently saved contacts: 3,000 entries
- Contacts loaded from the mobile phone: 5,000 entries per mobile phone

From the contacts menu, you can perform the following actions:

- Make a call, for example call a contact (→ page 240)

- Navigation (→ page 215)
- Compose messages (→ page 242)
- Additional options (→ page 240)

If a mobile phone is connected to the multimedia system (→ page 235) and automatic calling up (→ page 239) is activated, the mobile phone's contacts are displayed in the address book.

The multimedia system can show suggestions based on frequently used contacts as well as incoming and outgoing calls (→ page 198). These are shown at the top of the contact list.

### Downloading mobile phone contacts

Multimedia system:

   Phone 

 Select Device settings.

### Automatically

Activate  Synchronise contacts automatically.

### Manually

Deactivate  Synchronise contacts automatically.



 Select Synchronise contacts.

### Calling up contacts

Multimedia system:

   Phone 

The following options can be used to search for contacts:

- searching by initials
  - searching by name
  - searching by phone number
-  Enter characters into the search field.  
 Select the contact.  
Details for the contact are shown.

A contact can contain the following details:

- Phone numbers  
Telephone numbers can be saved as global favourites (→ page 199).
- Navigation addresses
- Geo-coordinates
- Internet address
- E-mail addresses



- Relation (if set)
- Information on messenger services

### Editing the format of a contact's name

Multimedia system:



- ▶ Select **Allgemein** (General).
- ▶ Select **Name format**.

The following options are available:

- **Surname, First name**
- **Surname First name**
- **First name Surname**

- ▶ Select an option.

### Overview of importing contacts

#### Contacts from various sources

Source	Requirements:
USB device	The USB device is connected with the USB port.
Bluetooth® connection	If the sending of vCards via Bluetooth® is supported, vCards can be received on mobile phones or net-books, for example.  Bluetooth® is activated in the multimedia system and on the respective device (see the manufacturer's operating instructions).

#### Importing contacts into the contacts menu

Multimedia system:



- ▶ Select an option.

#### Saving a mobile phone contact

Multimedia system:



- ▶ Select in the line of the mobile phone contact.
- ▶ Select .
- ▶ Select **Save in vehicle**.

- ▶ Select **Yes**.  
The contact saved in the multimedia system

is identified by the symbol.

#### Calling a contact

Multimedia system:



- ▶ Select **Search contacts**.
- ▶ Enter characters into the search field.
- ▶ Select the contact.
- ▶ Select the telephone number.  
The number is dialled.

#### Selecting further options in the contacts menu

Multimedia system:



- ▶ Select in the line of the contact.
- ▶ Select .

Depending on the stored data, the following options are available:

- **Add voice tag/Delete voice tag**
- **Set relation/Remove relation**
- **Send DTMF tones** (for a number with DTMF tones)  
The function is available when a call is active.
- ▶ Select an option.

#### Selecting options for suggestions in the contacts menu

##### Requirements:

- A profile has been created (→ page 197).
- The **Allow contact suggestions** setting is switched on (→ page 198).

Multimedia system:



- ▶ Select **Call list**.
- ▶ Select in the line of a suggested contact.

The following options are available:

- **Save as favourite**

The suggestions are saved as global favourites and do appear on the home screen.

- Do not suggest

▶ Select an option.

### Deleting contacts

#### Requirements:

- The contacts are saved in the vehicle.
- To delete an individual contact, this has been imported manually into the vehicle.

Multimedia system:

▶  ▶ Phone

#### Deleting all contacts

- ▶ Select .
- ▶ Select **Allgemein** (General).
- ▶ Select **Delete contacts**.
- ▶ Select an option.

#### Deleting a contact

- ▶ Select .
- ▶ Select  in the line of the contact.
- ▶ Select .
- ▶ Select **Delete contact**.
- ▶ Select **Yes**.

#### Saving a contact as a favourite

Multimedia system:

▶  ▶ Phone ▶  Add favourites

- ▶ Select a contact.
  - ▶ Select  in the line of the contact.
  - ▶ Select the telephone number.
- The contact is stored as a favourite in the telephone menu overview.

#### Deleting favourites in the telephone menu overview

Multimedia system:

▶ 

- ▶ Select a favourite in the telephone menu overview (→ page 241).
- ▶ Press and hold the favourite.
- ▶ Select **Delete**.
- ▶ Select **Yes**.

#### Deleting all favourites

- ▶ Briefly press  in the multimedia system display.

- ▶ Select **Phone**.
- ▶ Select .
- ▶ Select the connected phone.
- ▶ Select **Delete all favourites**.
- ▶ Select **OK**.

### Call list

#### Overview of the call list

Depending on whether your mobile phone supports the PBAP Bluetooth® profile or not, this can have different effects on the presentation and functions of the call list.

If the PBAP Bluetooth® profile is supported, the effects are as follows:

- The call lists from the mobile phone are displayed in the multimedia system.
- When connecting the mobile phone, you may have to confirm the connection for the PBAP Bluetooth® profile.

If the PBAP Bluetooth® profile is not supported, the effects are as follows:

- The multimedia system generates a call list independently as soon as calls are made in the vehicle.
- The call list is not synchronised with the call lists in the mobile phone.

The multimedia system can show suggestions based on frequently used contacts as well as incoming and outgoing calls (→ page 198). These are shown at the top of the call list.

#### Making a call from the call list

Multimedia system:



▶  ▶ Phone

- ▶ Select  **Call list**.
  - ▶ Select an entry.
- The call is made.

#### Calling up additional options in the call list

Multimedia system:

▶  ▶ Phone

- ▶ Select  **Call list**.
  - ▶ For previously stored contacts: select  in the line of an entry.
- The search results are displayed.

- ▶ For contacts who have not been stored: select .

### Selecting options for suggestions in the call list

#### Requirements:

- A profile has been created. (→ page 197)
- The [Allow contact suggestions](#) setting is switched on (→ page 198).

Multimedia system:

→  ▶ Phone

▶ Select  Call list.

▶ Select  in the line of a suggested entry.

The following options are available:

- [Save as favourite](#)
- [Do not suggest](#)

▶ Select an option.

### Deleting the call list

Multimedia system:

→  ▶ Phone ▶ 

▶ Select the connected mobile phone.

▶ Select [Delete call list](#).

▶ Select [Yes](#).

- ⓘ This function is only available if your mobile does not support the PBAP Bluetooth® profile.

## Text messages

### Overview of the messaging functions

In the messages menu you can receive and send text messages.

If the connected mobile phone supports the Bluetooth® MAP profile, the message function can be used on the multimedia system.

You can obtain further information about settings and supported functions of Bluetooth®-capable mobile phones from a Mercedes-Benz Service Centre or at: <http://www.mercedes-benz.com/connect>

Some mobile phones require further settings after being connected to the multimedia system (see manufacturer's operating instructions).

### Configuring displayed messages

Multimedia system:

→  ▶ Phone ▶ Messages

▶ Select .

The following options are available:

- [All messages](#)
- [New and unread messages](#)
- [Messages while the vehicle is in motion](#)
- [Off](#) (the message function is no longer available.)

▶ Select a setting.

### Reading messages

Multimedia system:

→  ▶ Phone ▶ Messages

▶ Select a contact.

The messaging history with this contact is shown.

### Reading a text message

▶ Select a message.

### Using the read-aloud function

▶ Select a message.

▶ Select .  
The message is read aloud.

### Dictating and sending a new message

#### Requirements:

- There is an Internet connection.

Multimedia system:

→  ▶ Phone ▶ Messages

▶  Select a new message.

### Adding a recipient

- ▶ Select .
- ▶ Select a contact.

### Dictating text

▶ Select .  
The dictating function is started.

▶ Say the message.  
After the voice message has been processed, it is shown as text.

## Sending a message

- ▶ Select **Send**.

 When the vehicle is stationary you can use the keyboard to write a message. No Internet connection is required to use the keyboard.

## Replying to a message in the messaging history

Multimedia system:

 ▶  ▶ **Phone** ▶ **Messages**

- ▶ Select a message sequence with a contact.
- ▶ Dictate the text and send the message (→ page 242).

## Using templates

Multimedia system:

 ▶  ▶ **Phone** ▶ **Messages**

## Using a template as a new message

- ▶ Select  in the menu for a new message.
- ▶ Add a recipient.
- ▶ Select a template.

## Answering a message with a template

- ▶ Select a message sequence with a contact.
- ▶ Select .
- ▶ Select a template.

## Forwarding a message

Multimedia system:

 ▶  ▶ **Phone** ▶ **Messages**

- ▶ Select a contact.
- ▶ Select a message.
- ▶ Select .
- ▶ Select **Forward**.

## Calling a message sender

Multimedia system:

 ▶  ▶ **Phone** ▶ **Messages**

- ▶ Select a contact.
- ▶ Select .
- ▶ Select **Call**.

## Using telephone numbers or URLs from a text message

### Requirements:

- An Internet connection is required to call up a URL.

Multimedia system:

 ▶  ▶ **Phone** ▶ **Messages**

- ▶ Select a message sequence with a contact.
- ▶ Select a message.
- ▶ Select a telephone number or a URL in the message.
  - If a URL is selected the web browser opens.
  - If a telephone number is selected the following options are available:
    - **Call**
    - **Write new text message**
- ▶ Select an option.

## Deleting a message

Multimedia system:

 ▶  ▶ **Phone** ▶ **Messages**

- ▶ Select a contact.
- ▶ Select a message.
- ▶ Select .
- ▶ **To delete the message:** select **Delete**.

## Apple CarPlay™

### Overview of Apple CarPlay™

 **WARNING** Risk of distraction from information systems and communications equipment

If you operate information and communication equipment integrated in the vehicle when driving, you will be distracted from the traffic situation. This could also cause you to lose control of the vehicle.

- ▶ Only operate this equipment when the traffic situation permits.
- ▶ If you cannot be sure of this, stop the vehicle whilst paying attention to road and traffic conditions and operate the equipment with the vehicle stationary.

You must observe the legal requirements for the country in which you are currently driving when operating the multimedia system.

iPhone® functions can be used via the multimedia system using Apple CarPlay™. They are operated using the touchscreen, Touch Control or the Siri® voice-operated control system. You can activate the voice-operated control system by pressing and holding the  button on the multifunction steering wheel.

When using Apple CarPlay™ via the voice-operated control system, the multimedia system can still be operated via LINGUATRONIC (→ page 182).

Only one mobile phone at a time can be connected via Apple CarPlay™ to the multimedia system.

Also for use of Apple CarPlay™ with two phone mode, only one additional mobile phone can be connected using Bluetooth® with the multimedia system.

The availability of Apple CarPlay™ may vary according to the country.

The service provider is responsible for this application and the services and content connected to it.

### Information on Apple CarPlay™

When Apple CarPlay™ is being used, the iPod® media source is not available for the respective iPhone®.



Only one route guidance can be active at a time. If route guidance is active on the multimedia system, it is closed when route guidance is started on the mobile phone.

### Connecting an iPhone® via Apple CarPlay™

#### Requirements:

- The current version of your device's operating system is being used (see the manufacturer's operating instructions).
- The full range of functions for Apple CarPlay™ is only available with an Internet connection.
- The iPhone® is connected to the multimedia system via the USB port  using a suitable cable (→ page 257).

Multimedia system:

  **Mercedes PRO & Apps** **» Smartphone** **» Apple CarPlay** **» Start Apple CarPlay**



### Accepting/rejecting the data protection provisions

A message with the data protection provisions appears.

 Select **Accept & start**.

 When the Apple CarPlay™ connection is active, you can switch **Start automatically** on or off.



### Exiting Apple CarPlay™

 Press the  button.

 If Apple CarPlay™ was not displayed full-screen before disconnecting, the application starts in the background when reconnected. You can call up Apple CarPlay™ in the main menu.

### Calling up Apple CarPlay™ sound settings

Multimedia system:

  **Mercedes PRO & Apps** **» Smartphone** **» Apple CarPlay** **» **

 Select sound settings.

### Ending Apple CarPlay™



 Disconnect the connecting cable between the mobile phone and multimedia system. Mercedes-Benz recommends disconnecting the connecting cable only when the vehicle is stationary.

## Android Auto

### Android Auto overview

 **WARNING** Risk of distraction from information systems and communications equipment

If you operate information and communication equipment integrated in the vehicle when driving, you will be distracted from the traffic situation. This could also cause you to lose control of the vehicle.

-  Only operate this equipment when the traffic situation permits.
-  If you cannot be sure of this, stop the vehicle whilst paying attention to road and traffic conditions and operate the equipment with the vehicle stationary.

You must observe the legal requirements for the country in which you are currently driving when operating the multimedia system.

Mobile phone functions can be used with Android Auto using the Android operating system on the multimedia system. It is operated using the touchscreen or the voice-operated control sys-

tem. You can activate the voice-operated control system by pressing and holding the  button on the multifunction steering wheel.

When using Android Auto via the voice-operated control system, the multimedia system can still be operated via LINGUATRONIC (→ page 182).

Only one mobile phone at a time can be connected via Android Auto to the multimedia system.

This also applies to two phone mode.

The availability of Android Auto and Android Auto Apps may vary according to the country.

The service provider is responsible for this application and the services and content connected to it.

### Information on Android Auto

While using Android Auto, various functions of the multimedia system, for example the media source Bluetooth® audio, are not available.

Only one route guidance can be active at a time. If route guidance is active on the multimedia system, it is closed when route guidance is started on the mobile phone.

### Connecting a mobile phone via Android Auto

#### Requirements:

- The first activation of Android Auto on the multimedia system must be carried out when the vehicle is stationary for safety reasons.
- The mobile phone supports Android Auto from Android 5.0.
- The Android Auto app is installed on the mobile phone.
- In order to use the telephone functions, the mobile phone must be connected to the multimedia system via Bluetooth® (→ page 235). If there was no prior Internet connection, this is established with the use of the mobile phone with Android Auto.
- The mobile phone is connected to the multimedia system via the USB port  using a suitable cable (→ page 257).
- The full range of functions for Android Auto is only possible with an Internet connection.

Multimedia system:

  **▶ Smartphone ▶ Mercedes PRO & Apps ▶ Android Auto ▶ Start Android Auto**



### Accepting/rejecting the data protection provisions

A message with the data protection provisions appears.

 Select **Accept & start**.

 When the Android Auto connection is active, you can switch **Start automatically** on or off.

### Exiting Android Auto

 Press the  button.

 If Android Auto was not displayed in the foreground before disconnecting, the application starts in the background when reconnected. You can call up Android Auto in the main menu.

### Calling up the Android Auto sound settings

Multimedia system:

  **▶ Mercedes PRO & Apps ▶ Smartphone ▶ Android Auto ▶ **

 Select sound settings.

### Ending Android Auto

 Disconnect the connecting cable between the mobile phone and multimedia system. Mercedes-Benz recommends disconnecting the connecting cable only when the vehicle is stationary.

### Transferred vehicle data with Android Auto and Apple CarPlay™

#### Overview of transferred vehicle data

When using Android Auto or Apple CarPlay™, certain vehicle data is transferred to the mobile phone. This enables you to get the best out of selected mobile phone services. Vehicle data is not directly accessible.

The following system information is transmitted:

- software release of the multimedia system
- system ID (anonymised)

The transfer of this data is used to optimise communication between the vehicle and the mobile phone.

To do this, and to assign several vehicles to the mobile phone, a vehicle ID is randomly generated.

This has no connection to the vehicle identification number (VIN) and is deleted when the multimedia system is reset (→ page 210).

The following vehicle status data is transmitted:

- transmission position engaged
- distinction between parked, standstill, rolling and driving
- day/night mode of the instrument cluster

The transfer of this data is used to alter how content is displayed to correspond to the driving situation.

The following position data is transmitted:

- coordinates
- speed
- compass direction
- acceleration direction

This data is only transferred while the navigation system is active, in order to improve it (e.g. so it can continue functioning when in a tunnel).

## Mercedes PRO connect

### Information about Mercedes PRO connect

Mercedes PRO connect provides the following services:

- Accident and breakdown management (Service button or automatic accident or breakdown detection)  
Use the service call button in the overhead control panel to make a call to the Mercedes-Benz Customer Centre (→ page 246). You can also select a menu entry in the multimedia system (→ page 246).
- Appointment requests or similar (Service call button)
- Mercedes-Benz emergency call system  
Use the  button (SOS button) in the overhead control panel to make a call to the Mercedes-Benz emergency call centre (→ page 246).

Mercedes PRO connect accident and breakdown management and the Mercedes-Benz emergency call centre are available for you around the clock for the use of the services.

Please note that Mercedes PRO connect is a Mercedes-Benz service. In emergencies, always call the national emergency services first using the standard national emergency service phone

numbers. In emergencies, you can also use the Mercedes-Benz emergency call system (→ page 248).

### Calling the Mercedes-Benz Customer Centre using the multimedia system

#### Requirements for using Mercedes PRO connect services in the vehicle:

- you have access to a GSM network
- the contract partner's GSM network coverage is available in the respective region
- the ignition must be switched on so that vehicle data can be transferred automatically

Multimedia system:





#### ▶ Call Mercedes PRO connect.

After confirmation, the multimedia system sends the required vehicle data.

The data transfer is shown in the multimedia system display. Then, you can select a service and be connected to a specialist at the Mercedes-Benz Customer Centre.

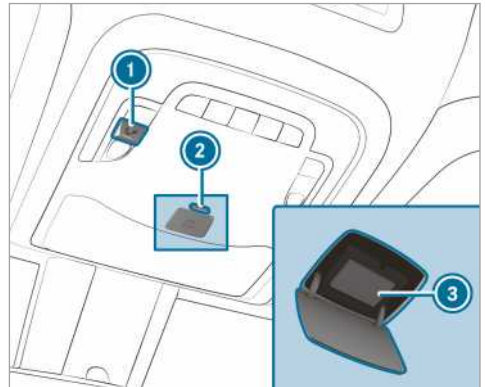
### Making a call via the overhead control panel



- ① Service call button
- ② Release catch for the cover on the  button (SOS button)
- ③  button (SOS button)

▶ **To make a service call:** press button ①.

▶ **To make an emergency call:** press the release catch for the cover on  button ② briefly to open.

▶ Press and hold  button ③ for at least one second.

An emergency call can still be triggered when a service call is active. This has priority over all other active calls.

### Information on the service call via the overhead control panel

A call to the Mercedes-Benz Customer Centre has been initiated via the Service call button in the overhead control panel.

In the event of a breakdown, you will get support:

- A qualified Mercedes-Benz technician carries out repairs on site and/or the vehicle will be towed to the nearest Mercedes-Benz Service Centre.

You may be charged for these services.

You can find information on the following topics:

- activation of Mercedes PRO connect
- operating the vehicle
- nearest Mercedes-Benz Service Centre
- other products and services from Mercedes-Benz

Data is transmitted during the connection to the Mercedes-Benz Customer Centre (→ page 247).

### Information on Mercedes PRO connect accident management

The Mercedes PRO connect accident management is an extension of the Mercedes-Benz emergency call system (→ page 248).

An emergency call is made to the Mercedes-Benz emergency call centre after an accident:

- a voice connection is made to a contact person at the Mercedes-Benz emergency call centre
- if necessary, the contact person at the Mercedes-Benz emergency call centre forwards the call to Mercedes PRO connect accident management
- if necessary, the vehicle will be towed to a Mercedes-Benz service centre

If the vehicle detects a minor accident, a message appears in the multimedia system.

The message is confirmed in the multimedia system:

- a voice connection is made to a contact person at Mercedes PRO connect accident management.
- if necessary, the vehicle will be towed to a Mercedes-Benz service centre.

### Arranging a service appointment via Mercedes PRO connect

If you have activated the maintenance management service, relevant vehicle data is transferred automatically to the Mercedes-Benz Customer Centre. You will then receive individual recommendations regarding the maintenance of your vehicle.

Regardless of whether you have consented to the maintenance management service, the multimedia system reminds you after a certain amount of time that a service is due. A prompt appears asking if you would like to make an appointment.

#### ▶ To arrange a service appointment: select Call.

After your confirmation, the vehicle data is sent and a Mercedes-Benz Customer Centre employee deals with your appointment. The information is then sent to your desired service outlet.

This service outlet will then contact you within 24 hours.

**i** If you select **Later** after the service message appears, the message is hidden and reappears after a certain period of time.

### Consenting to data transfer for Mercedes PRO connect

#### Requirements:

- There is an active service call (→ page 246).

If the accident and breakdown management services are not activated on Mercedes PRO, the **Do you want to transmit vehicle data and the vehicle's position to the Mercedes-Benz Customer Centre in order to improve the processing of your request?** message is shown.

▶ Select **Yes**.  
Relevant identification data is transmitted automatically.

More information on Mercedes PRO: <http://www.mercedes.pro>

### Transferred data during a service call

In certain countries you must confirm the data transfer.

When you make a service call via Mercedes PRO connect, various data will be transmitted.

Depending on which service is activated, the following data is transmitted when a call is made:

- vehicle identification number



- reason for the initiation of the call
- language set in the multimedia system
- confirmation of the data protection prompt
- current vehicle location
- service and workshop code
- selected data about the status of the vehicle

The following data is transmitted if no service is activated and the data protection prompt has been confirmed:

- vehicle identification number
- reason for the initiation of the call
- language set in the multimedia system
- confirmation of the data protection prompt

The following data is transmitted if the data protection prompt has been rejected:

- reason for initiating the call
- rejection of the data protection prompt

## Mercedes PRO

### Information about Mercedes PRO

When you log in with a user account to the Mercedes PRO portal, then services and offers from Mercedes-Benz Vans will be available to you.

Availability is country-dependent.

For more information consult a Mercedes-Benz Service Centre or visit the Mercedes PRO portal: <http://www.mercedes.pro>

## Mercedes-Benz emergency call system

### Information on the Mercedes-Benz emergency call system

The Mercedes-Benz emergency call system only functions in areas where mobile phone coverage is available from the relevant contract partner. Insufficient network coverage from the relevant contract partner may result in an emergency call not being transmitted.

The ignition must be switched on before an automatic emergency call can be made.

- ① The Mercedes-Benz emergency call system is activated at the factory. Using the Mercedes-Benz emergency call system is free of charge.

### Overview of the Mercedes-Benz emergency call system

The Mercedes-Benz emergency call system can help to decisively reduce the time between an accident and the arrival of emergency services at the site of the accident. It helps locate an accident site in places that are difficult to access.

The emergency call can be triggered automatically (→ page 248).

You also have the option of triggering the emergency call manually (→ page 249). Only make emergency calls if you or others are in need of rescue. Do not make an emergency call in the event of a breakdown or a similar situation.

### Notification in the multimedia system display:

**SOS NOT READY:** the ignition is not on or there is a malfunction with the emergency call system.

As soon as the emergency call system is available, the notification disappears.

During an active emergency call,  appears in the display.

You can find more information on the regional availability of the Mercedes-Benz emergency call system at: [http://www.mercedes-benz.com/connect\\_ecall](http://www.mercedes-benz.com/connect_ecall).

- ① If an emergency call is unavailable, a message to this effect appears in the multifunction display of the instrument cluster.

### Triggering an automatic emergency call

#### Requirements:

- The ignition is switched on.
- The starter battery has sufficient charge.

The Mercedes-Benz emergency call system triggers an emergency call automatically in the following cases:

- After activation of the restraint systems such as airbags or seat belt tensioners after an accident.
- After an automatically initiated emergency stop by Active Emergency Stop Assist

The emergency call has been made:

- A voice connection is made to the Mercedes-Benz emergency call centre.
- A message with accident data is transmitted to the Mercedes-Benz emergency call centre.

The Mercedes-Benz emergency call centre can transmit the vehicle position data to one of the public emergency services call centres.

- Under certain circumstances data is also transmitted in the voice channel to the Mercedes-Benz emergency call centre.

This allows measures for rescue, recovery or towing to a Mercedes-Benz Service Centre to be initiated quickly.

The SOS button in the overhead control panel flashes until the emergency call is finished.

It is not possible to immediately end an automatic emergency call.

If the Mercedes-Benz emergency call system cannot connect to the Mercedes-Benz emergency call centre, the emergency call is automatically sent to the public emergency services call centre.

If no connection can be made to the public emergency services, a corresponding message appears in the display.

- ▶ Dial the emergency number **112** on your mobile phone.

If an emergency call has been initiated:

- Remain in the vehicle if the road and traffic conditions permit you to do so until a voice connection is established with the emergency call centre operator.
- On the basis of the call, the operator decides whether it is necessary to call rescue teams and/or the police to the accident site.
- If no vehicle occupant answers, an ambulance is sent to the vehicle immediately.

### Triggering a manual emergency call

- ▶ **Using the SOS button in the overhead control panel:** press the SOS button at least one second long.

- ▶ **Using voice control:** use the LINGUATRONIC voice commands (→ page 187).

The emergency call has been made:

- A voice connection is made to the Mercedes-Benz emergency call centre.
- Remain in the vehicle if the road and traffic conditions permit you to do so until a voice connection is established with the emergency call centre operator.
- On the basis of the call, the operator decides whether it is necessary to call rescue teams and/or the police to the accident site.

- A message with accident data is transmitted to the Mercedes-Benz emergency call centre.

The Mercedes-Benz emergency call centre can transmit the vehicle position data to one of the public emergency services call centres.

- In certain situations data is also transmitted in the voice channel to the Mercedes-Benz emergency call centre.

This allows measures for rescue, recovery or towing to a Mercedes-Benz Service Centre to be initiated quickly.

If the Mercedes-Benz emergency call system cannot connect to the Mercedes-Benz emergency call centre, the emergency call is automatically sent to the public emergency services call centre.

If no connection can be made to the public emergency services, a corresponding message appears in the display of the multimedia system.

- ▶ Dial the emergency number **112** on your mobile phone.

### Ending an unintentional Mercedes-Benz emergency call

- ▶ Select  on the multifunction steering wheel.

### Transmitted data with the Mercedes-Benz emergency call system

In the event of an automatic or manual emergency call, as well as for a **112** emergency call, data is transmitted to the Mercedes-Benz emergency call centre or the public emergency services call centre.

The following data is transmitted:

- the vehicle's GPS position data
- the last GPS position data on the route (a few 100 metres before the incident)
- direction of travel
- vehicle identification number
- the vehicle drive type
- the estimated number of people in the vehicle
- whether Mercedes PRO connect is available or not
- whether the emergency call was initiated manually or automatically
- the time of the accident
- the language setting on the multimedia system

For accident clarification purposes, the following measures can be taken up to an hour after the emergency call has been initiated:

- the current vehicle position can be called up
  - a voice connection to the vehicle occupants can be established
- ① For Russia: various functions, e.g. receiving traffic information, cannot be used for up to two hours after sending an emergency call.

### Function of the emergency call system self-diagnosis (Russia)



Your car verifies the operability of the emergency call system each time the ignition is ON. In case of system failure, you will be informed with text message on the instrument cluster and with red indicator **SOS NOT READY** on the multimedia display.

Please, make sure, that during 3-10 seconds after switching ignition ON the red indicator **SOS NOT READY** in the upper right corner of the multimedia display is switched OFF, this means the emergency call system passed diagnostics successfully. If necessary, switch ON the multimedia display, if it was switched OFF before.

### Starting/ending ERA-GLONASS test mode (Russia)

#### Requirements:

- The starter battery has sufficient charge.
- The ignition is switched on.
- The vehicle has been stationary for at least one minute.

▶ **To start the test mode:** press and hold the  button on the multifunction steering wheel or the  button on the overhead control panel for at least five seconds. Test mode is started and ended automatically after completion of the speech test.

▶ **To stop test mode manually:** switch off the ignition or press the  button on the overhead control panel for at least five seconds. The test mode is ended.

## Online and Internet functions

### Internet connection

#### Information on connecting to the Internet

**⚠ WARNING** Risk of distraction from information systems and communications equipment

If you operate information and communication equipment integrated in the vehicle when driving, you will be distracted from the traffic situation. This could also cause you to lose control of the vehicle.

- ▶ Only operate this equipment when the traffic situation permits.
- ▶ If you cannot be sure of this, stop the vehicle whilst paying attention to road and traffic conditions and operate the equipment with the vehicle stationary.

You must observe the legal requirements for the country in which you are currently driving when operating the multimedia system.

**⚠ WARNING** Risk of distraction from operating mobile communication equipment while the vehicle is in motion

If you operate mobile communication equipment when driving, you will be distracted from the traffic situation. This could also cause you to lose control of the vehicle.

- ▶ Only operate this equipment when the vehicle is stationary.

You must observe the legal requirements for the country in which you are currently driving when operating mobile communication equipment in the vehicle.

To use Mercedes-Benz Apps and access the Internet, Mercedes PRO connect must be activated and operational. Furthermore, Mercedes PRO connect must be activated for Internet access.

Depending on the vehicle's equipment, you can establish an Internet connection in the following ways:

- **Vehicles with a communication module:** Internet use including Mercedes PRO connect services and data roaming (→ page 251).
- **Vehicles without a communication module:**
  - via Bluetooth® with a data-enabled mobile phone (→ page 251)

- via Wi-Fi with a data-enabled mobile phone (→ page 251)

The Internet functions can only be used to a limited degree whilst driving.

### Function of the communication module

On vehicles with a built-in communication module, the Internet connection is established via an integrated SIM card.

If the data volume limit is reached, the availability of Mercedes PRO connect services is limited. The data volume must be purchased via Mercedes PRO connect. Contact a Mercedes-Benz service centre to find out whether it is possible to purchase data volume in your country.

### Setting up an Internet connection via Wi-Fi

#### Requirements:

- the Wi-Fi function is activated on the multimedia system (→ page 206).
- the Wi-Fi function is activated on the external device (see the manufacturer's operating instructions).
- Internet access via Wi-Fi is activated (see the manufacturer's operating instructions).

The Internet connection via Wi-Fi is restricted or does not function if:

- the mobile phone is switched off.
- mobile data use is deactivated on the mobile phone.
- the Wi-Fi function is deactivated on the multimedia system.
- the Wi-Fi function is deactivated on the external device.
- Internet access via Wi-Fi is deactivated on the external device.

Multimedia system:

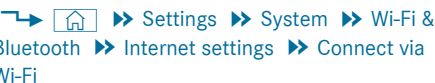
 Settings >> System >> Wi-Fi & Bluetooth >> Internet settings >> Connect via Wi-Fi

- ▶ Select the network.
- ▶ Logging in to a Wi-Fi network (→ page 206).

### Setting up an Internet connection via Bluetooth®

#### Requirements:

- The mobile phone support the Bluetooth® profile PAN (Personal Area Network).

- The mobile phone is connected to the multimedia system via Bluetooth® (→ page 235).

The Internet connection via Bluetooth® is restricted or does not function if:

- the mobile phone is switched off.
- the mobile phone is connected to an additional mobile phone.
- the mobile phone network coverage is insufficient.
- mobile data use is deactivated on the mobile phone.
- the Bluetooth® function on the multimedia system is switched off and the mobile phone is to be connected via Bluetooth®.
- the Bluetooth® function is switched off on the mobile phone and the mobile phone is to be connected via Bluetooth®.
- neither the mobile phone network nor the mobile phone allow simultaneous use of a phone and an Internet connection.
- the mobile phone has not been enabled for Internet access via Bluetooth®.

If a mobile phone is connected to the multimedia system for the first time via Bluetooth®, you will be assisted through the process of setting up an Internet connection.

The Internet connection can also be configured manually.

Further information can be obtained at <http://www.mercedes-benz.com/connect> or from a Mercedes-Benz Service Centre.

Multimedia system:

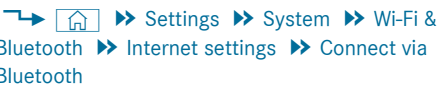
 Settings >> System >> Wi-Fi & Bluetooth >> Internet settings >> Connect via Bluetooth

- ▶ Select the mobile phone.
- ▶ The Internet connection is established.

### Establishing an automatic Internet connection

Multimedia system:

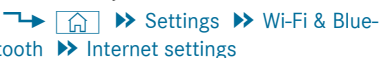
 Settings >> Wi-Fi & Bluetooth >> Internet settings

- ▶ Highlight the mobile phone.
- ▶ Select .



### Canceling Internet access permission for a mobile phone

Multimedia system:

→  » Settings » System » Wi-Fi & Bluetooth » Internet settings

- ▶ Select  in the line of the mobile phone.
- ▶ Select **Delete configuration**.
- ▶ Select **Yes**.

### Displaying mobile phone details

Multimedia system:

→  » Settings » System » Wi-Fi & Bluetooth » Internet settings

- ▶ Select  in the line of the mobile phone.
- ▶ Select **Details**.

### Establishing an Internet connection

Multimedia system:

→  » Mercedes PRO & Apps

- ▶ For example, select  **Browser**.

- ① The multimedia system usually establishes the Internet connection automatically. If the multimedia system is not connected to the Internet, the Internet connection is established when an Internet application is used.

### Setting automatic disconnection of the Internet connection

Multimedia system:

→  » Settings » System » Wi-Fi & Bluetooth » Internet settings

- ▶ Select  in the line of the mobile phone.
- ▶ Select **Disconnect when inactive**.

The following options are available:

- 5 minutes
  - 10 minutes
  - 20 minutes
  - Unlimited
- ▶ Select an option.

## Connection status

### Connection status overview

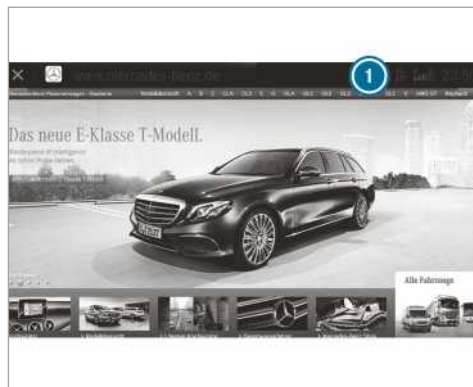

- ① Display of existing connection and reception field strength of the communication module or of the connected Bluetooth® device

### Displaying the connection status

Multimedia system:

→  » Settings » System » Wi-Fi & Bluetooth

- ▶ Select **Internet status**.
- ① When connected via Wi-Fi or a Bluetooth® device, the approximate data volume transmitted is displayed. The exact values can be requested from your mobile phone network provider.

## Web browser

### Calling up a web page

**⚠ WARNING** Risk of distraction from information systems and communications equipment

If you operate information and communication equipment integrated in the vehicle when driving, you will be distracted from the traffic situation. This could also cause you to lose control of the vehicle.

- ▶ Only operate this equipment when the traffic situation permits.
- ▶ If you cannot be sure of this, stop the vehicle whilst paying attention to road and traffic conditions and operate the equipment with the vehicle stationary.

You must observe the legal requirements for the country in which you are currently driving when operating the multimedia system.  
Multimedia system:

➤ ➤ MERCEDES PRO & APPS ➤ Browser

### Calling up a new web page

➤ Select **URL**.

➤ Entering a web address

➤ Select **ok**.

The function is country-dependent.

Websites cannot be shown while the vehicle is in motion.

### Calling up a website from the browser history

➤ To call up the previous or next page from the history: select **←** or **→**.

### Web browser overview

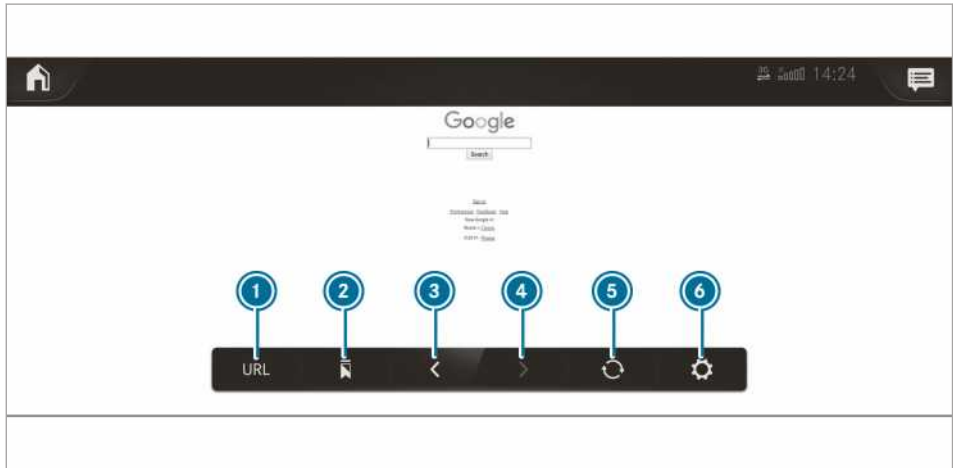

URL entry

Bookmarks

Web page, back

Web page, forwards

To refresh/stop

Options

### Calling up web browser options

Multimedia system:

➤ ➤ MERCEDES PRO & APPS ➤ Browser ➤

The following functions are available:

- **Bookmarks**
- **Options** with the settings:
  - **Browser settings**
  - **Delete browser data**

➤ Select an option.

➤ Change the settings.

### Calling up the web browser settings

Multimedia system:

➤ ➤ MERCEDES PRO & APPS ➤ Browser ➤ ➤ **Browser settings**

The following functions are available:

- **Block popups**
- **Enable Javascript**
- **Enable cookies**

➤ Switch a function on  or off .

### Deleting Internet history

Multimedia system:

  MERCEDES PRO &  
 APPS  Browser  Delete  
 browser data

The following options are available:

- All
- Cache
- Cookies
- Entered URLs

 Select an option.

 Select **Yes**.

### Managing bookmarks

Multimedia system:

  MERCEDES PRO &  
 APPS  Browser

 Select .

### Selecting a bookmark

 Select an entry.

### Creating a bookmark

 Select **Add current site to bookmarks**.

 Enter a name.

 Select **Bestätigen** (Confirm).

### Editing a bookmark

 Select  after a bookmark.

 Select **Edit**.

 Enter a name.

 Select **Bestätigen** (Confirm).

### Deleting a bookmark

 Select  after a bookmark.

 Select **Delete**.

 Select **Yes**.

### Closing the browser

Multimedia system:

  MERCEDES PRO &  
 APPS  Browser

 Select .

### Internet radio

#### Calling up Internet radio

#### Requirements:

 The Internet radio function is only available in certain countries.

- The service is available.
- The data volume is available.

Depending on the country, data volume may need to be purchased.

- A fast Internet connection for data transmission free of interference.

The services are country-dependent.

For more information, consult a Mercedes-Benz Service Centre.

Multimedia system:

  Radio

 Select **Tuneln radio**.

The Internet radio menu appears. The last station set starts playing.

 The connection quality depends on the local mobile phone reception.

## Internet radio overview



- |  |                |                           |
|--|----------------|---------------------------|
| ① Additional information on the current station  | ④ Options      | ⑧ Search                  |
| ② Display (if connected to private user account) | ⑤ Favourites   | ⑨ Selected category       |
| ③ Data transfer rate                             | ⑥ To start/end | ⑩ Internet radio provider |
|  | ⑦ To browse    |                           |

### Selecting and connecting to Internet radio stations

Multimedia system:

→ ▶▶ Radio ▶▶ Tuneln radio

- ▶ Select .
- ▶ Select a category.
- ▶ Select a station.  
The connection is established automatically.

or

- ▶ Select the search field.
- ▶ Enter a station name using the entry field.
- ① A relatively large volume of data can be transmitted when using Internet radio.

### Saving/deleting Internet radio stations as favourites

Multimedia system:

→ ▶▶ Radio ▶▶ Tuneln radio

- ▶ Select a station.
- ▶ Select .
- ▶ The list of saved favourite stations appears.
- ▶ Select [Add to favourites](#).

or

- ▶ Create an account for the online provider (Tuneln radio) and then log in on the multimedia system.  
Your favourites are imported to the multimedia system.

### Deleting favourites

- ▶ Select a station.
- ▶ Select .
- ▶ Select [Delete favourites](#).

### Setting Internet radio options

Multimedia system:

→ ▶▶ Radio ▶▶ Tuneln radio ▶▶

The following options are available:

- [Select stream](#): select the stream quality.
- [Login to Tuneln account](#): log in to your Tuneln user account.
- [Log out of account](#): log out of your Tuneln user account.
- ▶ Select an option.



### Calling up the station list for the category last selected

Multimedia system:



- ▶ Press the cover of the current station. Depending on how the station was selected, a station list is shown.

## Media

### Information about media mode

#### Information about supported formats and data storage media

**⚠ WARNING** Risk of distraction when handling data storage media

If you handle a data storage medium while driving, your attention is diverted from the traffic conditions. This could also cause you to lose control of the vehicle.

- ▶ Only handle a data storage medium when the vehicle is stationary.

#### The multimedia system supports the following formats and data media:

Permissible file systems	FAT32, exFaT, NTFS
Permissible data carriers	USB devices, iPod®/iPhone®, MTP devices, Bluetooth® audio equipment
Supported formats:	<p><b>Audio:</b> MP3, WMA, AAC, WAV, FLAC, ALAC</p> <p><b>Video:</b> MPEG, AVI, DivX, MKV, MP4, M4V, WMV</p>

- The multimedia system supports a total of up to 50,000 files.
- Data storage media up to 2 TB are supported (32-bit address space).

**i** Observe the following notes:

- Due to the large variety of available music and video files regarding encoders, sampling rates and data transfer rates, playback cannot always be guaranteed.
- Due to the wide range of USB devices available on the market, playback cannot be guaranteed for all USB devices.
- Videos up to FullHD (1920x1080) are supported.

- Copy-protected music and video files or DRM (Digital Rights Management) encrypted files cannot be played back.
- MP3 players must support Media Transfer Protocol (MTP).

#### Information on copyright protection and trademarks

Audio files that you create or reproduce yourself for playback are generally subject to copyright protection. In many countries, reproductions, even for private use, are not permitted without the prior consent of the copyright holder. Make sure that you know about the applicable copyright regulations and that you comply with these.



Manufactured under licence from Dolby Laboratories. Dolby, Dolby Audio and the double-D symbol are trademarks of Dolby Laboratories.



Gracenote, the Gracenote logo and logotype, "Powered by Gracenote", MusicID and Playlist Plus are either registered trademarks or trademarks of Gracenote, Inc. in the United States and/or other countries.



For DTS patents, see <http://patents.dts.com>. Manufactured under license from DTS Licensing Limited. DTS, the Symbol, & DTS and the Symbol together are registered trademarks, and DTS TruVolume is a trademark of DTS, Inc. © DTS, Inc. All Rights Reserved.

## Overview of the media menu

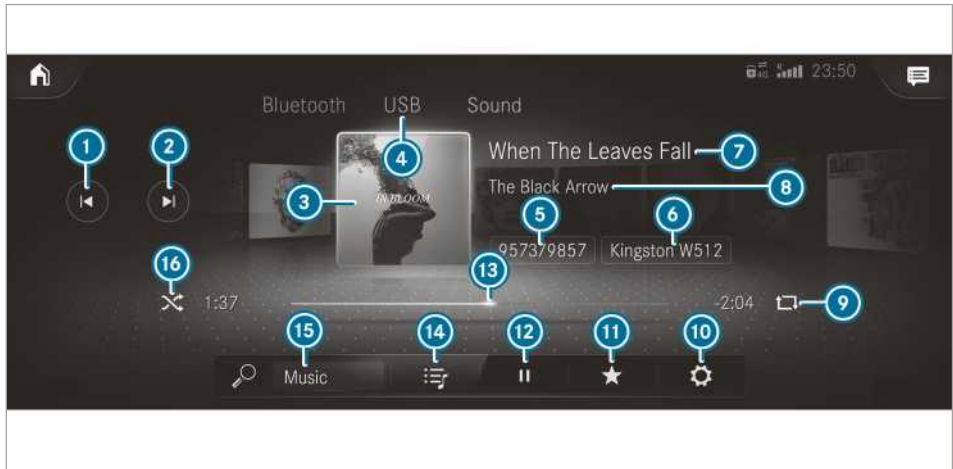

- |  |                              |                     |
|--|------------------------------|---------------------|
| ① Previous track or fast rewind            | ⑥ Active data storage medium | ⑫ Controls playback |
| ② Next track or fast forward               | ⑦ Track title                | ⑬ Timeline          |
| ③ Album cover                              | ⑧ Artist                     | ⑭ Categories        |
| ④ Active media source                      | ⑨ Repeat                     | ⑮ Music search      |
| ⑤ Current track/track in the playback list | ⑩ Settings (video mode only) | ⑯ Random playback   |
|  | ⑪ Additional options         |                     |

## Connecting the data storage media to the multimedia system

### Connecting USB devices

**!** **NOTE** Damage caused by high temperatures

High temperatures can damage USB devices.

- ▶ Remove the USB device after use and take it out of the vehicle.

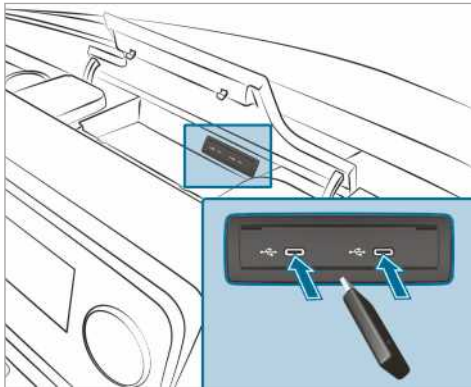

The multimedia connection unit is found in the stowage compartment in the centre console and has two type C USB ports.

▶ Connect the USB device to the USB port.

ⓘ When connecting several Apple® devices simultaneously, pay attention to the order in which the devices are connected. The multimedia system only connects with the device that is connected first. Additional Apple® devices that are connected at the same time are only supplied with power.

### Searching for and authorising a Bluetooth® audio device

#### Requirements:

- Bluetooth® is activated on the multimedia system and audio equipment.
- The audio equipment supports the Bluetooth® audio profiles A2DP and AVRCP.
- The audio equipment is "visible" for other devices.

Multimedia system:

→ 🏠 ▶▶ Media ▶▶ Bluetooth ▶▶ 📶

### Authorising a new Bluetooth® audio device

- ▶ Select **Connect new device**. Detected equipment is displayed in the device list.
- ▶ Select an audio device. Authorisation starts. A code is displayed on the multimedia system and on the mobile phone.
- ▶ If the codes are identical, confirm on the audio equipment.

- ▶ Select **Only as Bluetooth audio device**. The Bluetooth® audio equipment is connected with the multimedia system.

### Connecting previously authorised Bluetooth® audio equipment

- ▶ Select a Bluetooth® audio device from the list. The connection is established.

### Starting media playback

A data storage medium is connected to the multimedia system.

Multimedia system:

→ 🏠 ▶▶ Media

- ▶ Select **USB** or **Bluetooth** as the media source.

### Controlling media playback

Multimedia system:

→ 🏠 ▶▶ Media

- ▶ **To pause playback:** select .

- ▶ **To continue playback:** select .

- ▶ **To repeat a track:** select .

For the repeat function there are the following settings:

- **Select once:** the active playlist is repeated.
- **Select twice:** the current track is repeated.
- **Select three times:** the repeat function is deactivated.



- ▶ **To play back tracks in random order:**

select .

- ▶ **To wind a track forwards or backwards:** tap on the desired point on the timeline.

- ▶ **To select the next track:** select .

- ▶ **To select the previous track:** select .

- ▶ **To scroll through tracks quickly:** press and hold  or .

- ▶ **To show the current track list:** select the track image shown.

## Additional options for setting media playback

Multimedia system:



### Calling up additional options

- ▶ Select . The additional options are shown.

The following options are available:

- **Play similar tracks**  
Select during playback of a track in order to create a playlist with similar tracks
- **Surprise mix**  
A playlist with randomly selected tracks is created.
- **Add to favourite songs**  
The current track is added to the favourite songs.
- **Delete from favourite songs**  
The current track is removed from the favourite songs.
- ▶ Select an option.

## Media search

### Information about the search function in categories

Under  **My Music** you can search through all available media files. There are several categories available for selection. The categories shown depend on the connected device and data format.

Available categories with Bluetooth® audio equipment:

- **Current tracklist**  
The folders and categories of the connected device are shown.

Available categories with audio files:

- **Current tracklist**
- **Playlists**
- **Folder**
- **Albums**
- **Artists**
- **Tracks**
- **Favourite songs**
- **Frequently played**

- **Most recently added**
- **Mood** (→ page 260).
- **Music genres**
- **Year**
- **Composers**
- **Select by cover**
- **Podcasts** (Apple® devices)
- **Audiobooks** (Apple® devices)

Available categories with video files:

- **Folder**
  - **Videos**
-  The categories are available as soon as the entire media content has been read in and analysed.



### Starting a search in categories

Multimedia system:



- ▶ Select a category. The media files are shown corresponding to the selected category, e.g. all albums will be shown for the **Albums** category.

### Sorting results shown or playing back all media found

- ▶ Select .
  - ▶ **To play back all results found in the category:** select **Play all**.  
If, for example, the album category is active, all albums found by the desired artist will be played back.
  - ▶ **To sort results alphabetically:** select **Sort from A-Z**.
  - ▶ **To sort results in reverse alphabetical order:** select **Sort from Z-A**.
-  The available options depend on the selected category and the connected device.

### Using the keyword search

Multimedia system:



In the categories under  **My Music** you can use the keyword search with free text input to look for content.

- ▶ Select a category.

- ▶ Select **Search**.  
A keyboard for character entry appears.
- ▶ Enter the term searched for.
- ① The search begins with the first character entered. The more characters entered the more concrete the search results become.
- ▶ Select the desired entry from the result list. If the selected result is an album, song or a playback list then playback is started. If the selected result is a new category then this is opened in the search.

### Searching for a track according to mood

Multimedia system:

→ [Home] ▶▶ Media ▶▶ My Music

Using the My Music search, you can find music tracks suitable for a mood.

- ▶ Select **Mood**.  
A grid with the following moods appears:
  - Positive
  - Calm
  - Dark

- **Energetic**
- ▶ Pull the controller to the desired position.  
The system searches for tracks that are suitable for the mood entered.

### Making video settings

Multimedia system:

→ [Home] ▶▶ Media ▶▶ [Settings]

- ▶ Select **Video settings**.
- ▶ Select an aspect ratio.

### Setting full screen

- ▶ Select [Full Screen].

## Radio

### Switching on the radio

Multimedia system:

→ [Home] ▶▶ Radio

- ▶ Alternatively: press the [RADIO] button.  
The radio display appears. You will hear the last station played on the last frequency band selected.

### Radio overview



- |                                       |                             |                |
|---------------------------------------|-----------------------------|----------------|
| ① Active frequency band               | ④ Options                   | ⑧ Search field |
| ② Station name or set frequency       | ⑤ Full screen/DAB slideshow |                |
| ③ Artist, title, album and radio text | ⑥ Mute function             |                |
|                                       | ⑦ Station list              |                |

## Setting the frequency band

Multimedia system:



- ▶ Select a frequency band.

## Selecting a radio station

Multimedia system:



- ▶ Swipe to the left or right on the control element.

## Calling up the radio station list

Multimedia system:





- ▶ Select . The station list appears.
- ▶ Select a station.

## Searching for radio stations using station names or direct frequency entry

Multimedia system:



- ▶ Select .
- ▶ Select .
- ▶ Enter a station name or frequency.
- ▶ Select a station.

## Storing radio stations

Multimedia system:



- ▶ Select a radio station.

### Memory slots are available in station presets

- ▶ Select .

or

- ▶ Press and hold on the radio station.

### Replacing an entry in the station presets

- ▶ Press and hold on an entry in the station presets.
- ▶ Select **Yes**.

## Editing station presets

Multimedia system:



### Moving stations:

- ▶ Press and hold a stored station.
- ▶ Select **Move**.
- ▶ Move the station to the new position.

### Deleting stations:

- ▶ Press and hold a station.
- ▶ Select **Delete**.

### Replacing a station:

- ▶ Press and hold a station.
- ▶ Select **Replace radio station**.

## Activating or deactivating the frequency fix function

Multimedia system:



- ▶ Select **Frequency fix** to switch on or off. If the function is activated, the set frequency is kept even if the reception is poor.

## Switching traffic announcements on/off

Multimedia system:



- ▶ Switch **Traffic announcements** on or off.

## Setting the traffic information service volume increase

Multimedia system:



- ▶ Select **Other sound settings**.
- ▶ Select **Navigation and traffic announcements**.
- ▶ Select **TRAFFIC ANNOUNCEMENTS VOLUME INCREASE**.
- ▶ Adjust the value.
- ▶ To accept the value: select .

## Displaying radio text

Multimedia system:



- ▶ Switch Display radio text information on or off.

## Sound

### Tone settings

#### Information about the sound system

The sound system is available for all functions in the radio and media modes. The settings, for example for the equaliser, effect the playback of all media sources.

#### Calling up the sound menu

Multimedia system:



The following functions are available:

- Equaliser
- Balance and Fader
- Auto. volume adjustment

- ▶ Select a sound menu.

#### Adjusting treble, mid-range and bass settings

Multimedia system:



- ▶ Set TREBLE, MID or BASS.

#### Activating/deactivating automatic volume adjustment

Multimedia system:



Auto. volume adjustment

Automatic volume adjustment compensates for differing volumes when changing between audio sources.

- ▶ Switch Auto. volume adjustment on or off.

#### Adjusting the balance/fader

The availability of this function depends on the vehicle equipment.

Multimedia system:



- ▶ Adjust the balance and fader.

**Notes on loading guidelines****⚠ WARNING** Risk of exhaust gas poisoning

Combustion engines emit poisonous exhaust gases such as carbon monoxide. Exhaust gases can enter the vehicle interior if the rear-end door is open when the engine is running, especially if the vehicle is in motion.

- ▶ Always switch off the engine before opening the rear-end door.
- ▶ Never drive with the rear-end door open.

**⚠ WARNING** Risk of injury from unsecured objects in the vehicle

When objects are unsecured or inadequately secured, they can slip, tip over or be thrown about, striking vehicle occupants.

This also applies to:

- luggage or loads
- seats which have been removed and are being transported in the vehicle in an exceptional case

There is a risk of injury, particularly in the event of braking manoeuvres or abrupt changes in direction.

- ▶ Always stow objects in such a way that they cannot be tossed about.
- ▶ Before travelling, secure objects, luggage or load to prevent them slipping or tipping over.
- ▶ When a seat is removed, keep it preferably outside the vehicle.

**⚠ WARNING** Risk of injury due to objects being stowed incorrectly

If objects in the vehicle interior are stowed incorrectly, they can slide or be thrown around and hit vehicle occupants. In addition, cup holders, open stowage spaces and mobile phone brackets cannot always retain all objects they contain.

There is a risk of injury, particularly in the event of sudden braking or a sudden change in direction.

- ▶ Always stow objects so that they cannot be thrown around in such situations.

- ▶ Always make sure that objects do not protrude from stowage spaces, luggage nets or stowage nets.
- ▶ Close the lockable stowage spaces before starting a journey.
- ▶ Stow and secure objects that are heavy, hard, pointed, sharp-edged, fragile or too large in the load compartment.

**⚠ WARNING** Risk of burning from the tailpipe or tailpipe trim

The tailpipe and tailpipe trim can become very hot. If you come into contact with these car parts, you could burn yourself.

- ▶ Always be particularly careful when in the vicinity of the tailpipe and tailpipe trims and supervise children very closely when in this area.
- ▶ Before any contact, allow the car parts to cool down.

If you are using a roof rack, please note the maximum roof load and the maximum load capacity of the roof rack.

You will find information about the maximum roof load in the "Technical data" chapter and information about roof racks in the "Carrier systems" section.

Camera-based driving systems and the sensor functions of the inside rearview mirror may be impaired if you are transporting a load on the roof and it protrudes more than 40 cm over the edge of the roof. Therefore, make sure that the load does not overhang by more than 40 cm.

The handling characteristics of your vehicle are dependent on the load distribution. Therefore, please observe the following notes when loading:

- when transporting a load, never exceed the permissible gross mass or the permissible axle loads for the vehicle (including occupants).
- the load must not protrude above the upper edge of the seat backrests.
- if possible, always transport the load in the load compartment.
- fasten the load to the tie-down eyes and spread the load as evenly as possible.
- use tie-down eyes and fastening components which are suitable for the weight and size of the load.



## Load distribution

### **I** NOTE Risk of damage to the floor covering

Excessive point loading on the load compartment floor or on the load area can negatively affect the driving characteristics and could damage the floor covering.

▶ **Vehicles with rear wheel drive:** distribute the load uniformly. While doing so, ensure the overall centre of gravity of the load is always as low as possible, centred and between the axles near the rear axle.

▶ **Vehicles with front wheel drive:** distribute the load uniformly. While doing so, ensure the overall centre of gravity of the load is always as low as possible, centred and between the axles near the front axle.

Excessive point loading on the load compartment floor or on the load area can negatively affect the driving characteristics and could damage the floor covering.

For panel vans and crewbuses:

- always transport loads in the load compartment.
- always place the load against the seat backrests of the rear bench seat.
- move large and heavy loads as far towards the front of the vehicle as possible against the rear bench seat. Stow loads flush with the rear bench seat.
- always additionally secure the load with suitable load securing aids or lashing material.
- the load must not protrude above the upper edge of the seat backrests.
- transport loads behind seats that are not occupied.
- if the rear bench seat is not occupied, insert the seat belts crosswise into the seat belt buckle of the opposite seat belt.

## Securing loads

### Notes on load securing

### **A** WARNING Risk of accident and injury due to incorrect use of the lashing straps

If you attach the lashing strap incorrectly when securing loads, the following may occur in the event of abrupt changes in direction, braking manoeuvres or an accident:

- the tie-down eyes may become detached or the lashing strap may tear if the permissible load is exceeded.
- the load cannot be restrained.

This may cause the load to slip, tip over or be flung about, striking vehicle occupants.

▶ Always tension the lashing straps in the proper manner and only between the described tie-down eyes.

▶ Always use lashing straps designed specifically for the loads.

- i** Observe the information relating to the maximum loading capacity of the individual lashing points. If you combine various lashing points to secure a load, you must always take the maximum loading capacity of the weakest lashing point into account. During a full brake application, forces may act which can multiply the weight of the load. Always use several lashing points to distribute and spread the load. Spread the load evenly between the lashing points or tie-down eyes.

Always observe the operating instructions or the lashing strap manufacturer's instructions for the operation of the lashing strap.

Information on the maximum loading capacity of the lashing points (→ page 342)

As the driver, you are responsible for ensuring that:

- The load is secured against slipping, tipping, rolling or falling off.  
Take usual traffic conditions as well as swerving or full brake application and bad roads into account.
- The applicable requirements and guidelines relating to load-securing practices are met.  
If this is not the case, this may constitute a punishable offence, depending on local legislation and any ensuing consequences.  
Observe country-specific laws.

Make sure that the load is secure before every journey and at regular intervals during a long journey. Adjust the load securing as necessary. Information on how to secure loads correctly can be obtained from the manufacturers of load securing aids or lashing material for load-securing, for example.

- Fill spaces between the load and the load compartment walls or wheel wells. For this purpose use rigid load securing aids, such as wedges, wooden fixings or padding.
- Attach secured and stabilised loads in all directions.

Use the lashing points or tie-down eyes and the loading rails in the load compartment or on the load surface.

Only use lashing material, such as lashing rods or lashing nets and lashing straps, which has been tested in accordance with current standards (e.g. DIN EN). Always use the lashing points closest to the load; pad sharp edges.

Loads, and heavy loads in particular, should preferably be secured using the tie-down eyes.

- ① Lashing material tested in accordance with current standards (e.g. DIN EN) is available from any specialist company or from a qualified specialist workshop.

### Overview of lashing points

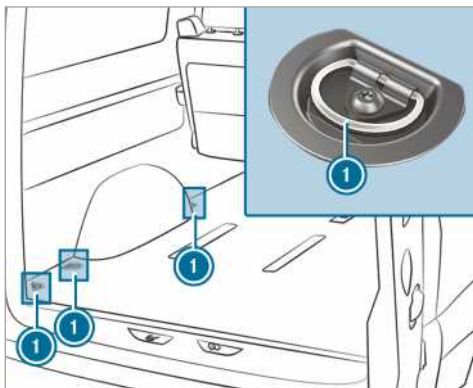

Lashing points (example: crewbus)

- ① Tie-down eyes

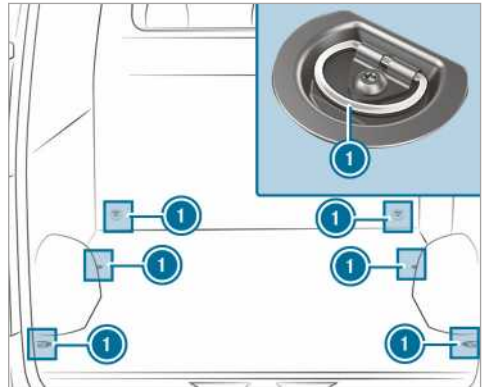

Lashing points (example: panel van without loading rails)

- ① Tie-down eyes

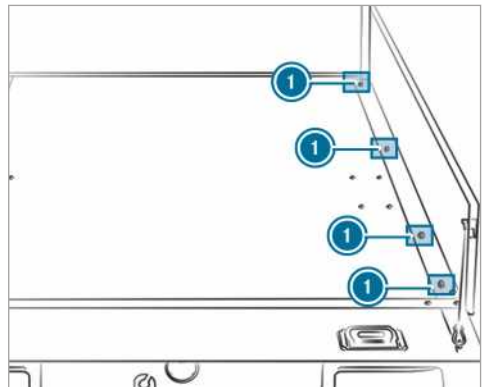

Lashing points (example: platform vehicle)

- ① Tie-down eyes

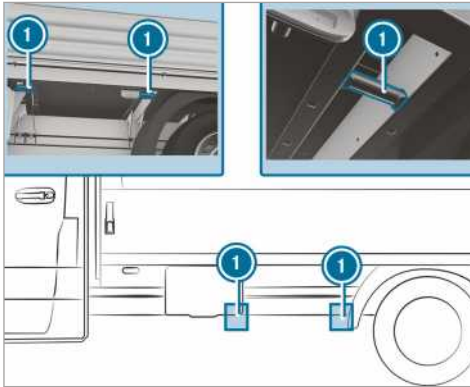

Lashing points (example: platform vehicle)

### ① Tie-down eyes

Once you have removed the platform dropsides, you can use the lashing points on the bottom left and right of the crossmember.

Secure loose loads, in particular on the load surface of a platform vehicle, with an approved lashing net or tarpaulin.

Always fasten the lashing net or tarpaulin to all available lashing points. Make sure that the fastening hooks are secured against accidental opening.

If your vehicle is equipped with loading rails in the load compartment floor, you can place lashing rods directly in front of and behind the load. The lashing rods directly absorb the potential shifting forces.

Securing loads on the load compartment floor by lashing them down is only recommended for lightweight loads. Lay anti-slip mats underneath the load to secure the load additionally.

## Fitting and removing tie-down eyes

▶ **To fit:** slide the tie-down eye through a recess in the loading rail close to the load until locking mechanism engages in the recess.

① When you pull locking mechanism up and out of the recess, the tie-down eye is able to move within the loading rail. Make sure that locking mechanism is always engaged in a recess.

▶ Check the tie-down eye for firm seating.

▶ **To remove:** pull locking mechanism up and pull the tie-down eye towards the locking

mechanism and out of the loading rail through a recess.

## Carrier systems

### Roof rack

⚠ **WARNING** Risk of injury due to the maximum roof load being exceeded

When you place a load on the roof as well as all outer and inner attachments, the vehicle's centre of gravity will rise and the familiar driving characteristics as well as the steering and braking characteristics will change. When driving around bends, the vehicle will tilt more heavily and may react more sluggishly to steering movements.

If you exceed the maximum roof load, the driving characteristics, as well as the steering and braking, will be greatly impaired.

▶ Never exceed the maximum roof load and adjust your driving style.

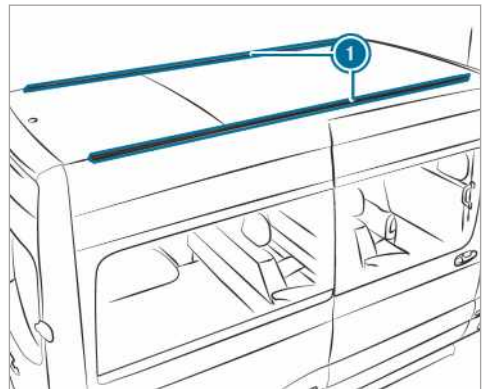

### ① Mounting rails

Information about the maximum roof load can be found in the "Technical data" section (→ page 343).

Observe the following points for assembling roof racks:

- Tighten the roof rack's screws to a torque of 8 Nm – 10 Nm in the designated grooved plates.
- The tightened screws should not touch the rails.

- Ensure that the grooved plates are not located in the areas around the plastic caps.
- The grooved plates must have the right cross-section.
- The insides of the mounting rails must be free of dirt.
- Re-tighten the screws uniformly after around 500 km.

Mercedes-Benz recommends that you use only roof racks that have been tested and approved for Mercedes-Benz. These help to prevent vehicle damage.

If you want to retrofit the mounting rails, have them installed at a qualified specialist workshop. Otherwise, you could damage the vehicle.

If your vehicle is fitted with mounting rails on the roof, you can install a roof rack on the roof. Special fasteners (sliding blocks) are available as accessories for this purpose.

These fasteners are available from any Mercedes-Benz service centre.

## Ladder rack

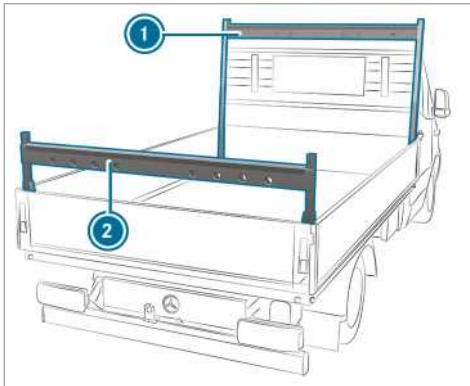

Ladder rack on a platform vehicle (example)

- ① Front ladder rack
- ② Rear ladder rack

Comply with the important safety instructions in the section entitled "Notes on loading" (→ page 73).

Information about the maximum load for ladder racks can be found in the section entitled "Technical data" (→ page 343).

## Interior roof rack system

- ❗ **NOTE** Risk of damage to the belt straps and slides

Excessive point loading on the belt straps and slides may cause the belt straps to tear off or cause the slides to break off from the carrier rail.

- ▶ Distribute the load evenly. While doing so, ensure the overall centre of gravity of the load is always as centred as possible and between the axles near the rear axle.

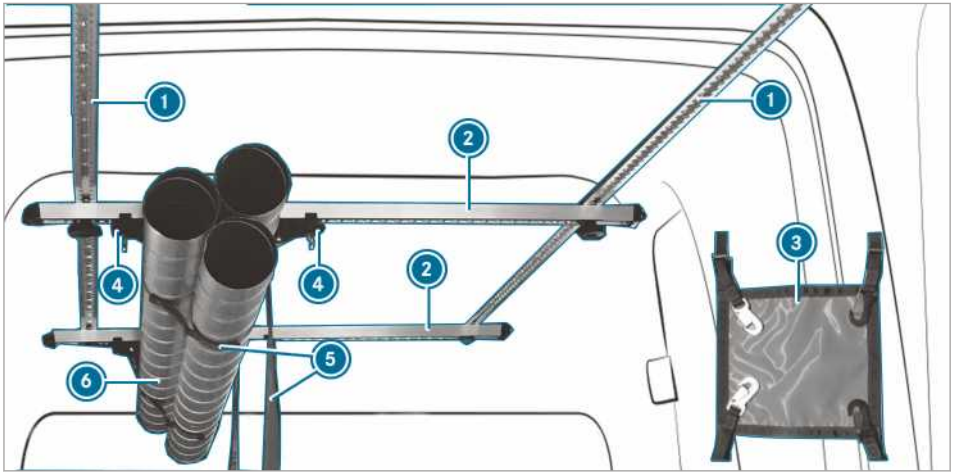

You can use the interior roof rack system to secure loads. It is also suitable for securing long loads.

**i** The interior roof rack system may be subjected to a load of 50 kg.

The interior roof rack system consists of the following components:

- Roof rails **1**, which are attached to the roof of the vehicle.
- Rack rails **2**, which are screwed onto the roof rails and can be moved.
- Rack rail **2** is equipped with sliding rail pair **4**. Sliding rail pair **4** with attached belt strap **5** can be moved. Load **6** is stowed by placing and lashing it in belt strap **4**.
- The load can also be secured using head lashing **3**.

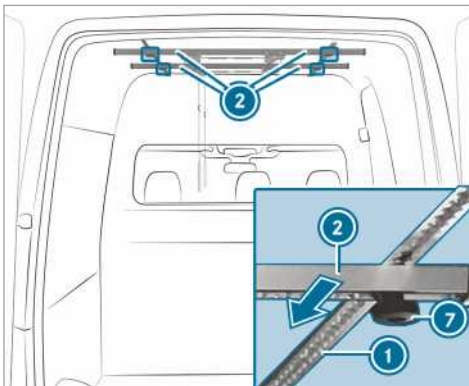

- ▶ **To move the rack rails:** unscrew star knob nuts **2** anti-clockwise until they are slightly loose.
- ▶ Slide rack rail **1** along roof rail **3** to the desired position.
- ▶ Screw star knob nuts **2** tight clockwise.
- ▶ Check that the rack rail is seated securely.

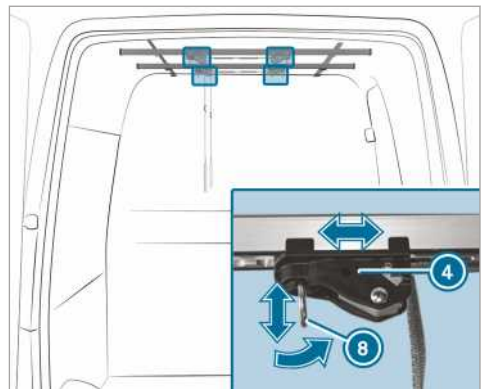

- ▶ **To move the sliding rails:** pull carabiner **2** of sliding rail **1** down and simultaneously slide sliding rail **1** to the desired position.
- ▶ Release the carabiner at the desired position. The sliding rail locks automatically.

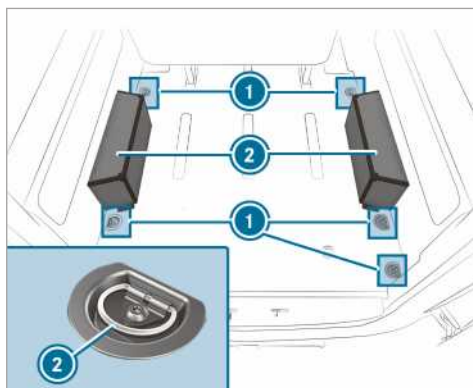
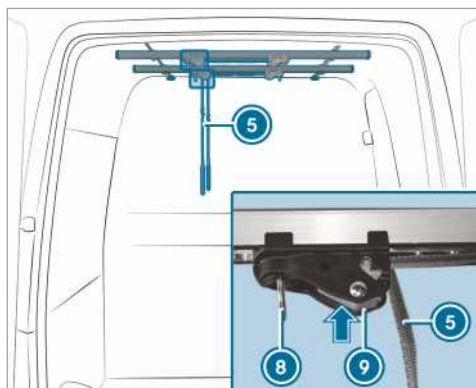

- ▶ **To adjust the belt strap:** press and hold the locking mechanism on sliding rail ②.
- ▶ Pull or release belt strap ①.
- ▶ Release the locking mechanism on sliding rail ②.
- ▶ **To secure the load:** place the load in the belt straps of the rack rails.
- ▶ Secure belt strap ①.
- ▶ Check that the load is seated securely.

- ▶ Place the objects on wheel arch ② and lash them using tie-down eyes ① (→ page 265).
- ⓘ A wheel arch may be subjected to a load of 150 kg.

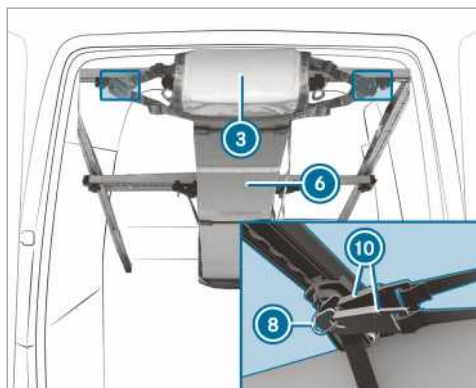

- ▶ **To attach the head lashing:** tension head lashing ① at both ends of load ② and attach two hooks of head lashing ① to carabiners ③.

### Placing a load on the wheel arch

Comply with the important safety notes under "Notes on loading" (→ page 73).

## ASSYST PLUS service interval display

### Function of the ASSYST PLUS service interval display

The ASSYST PLUS service interval display on the instrument display provides information on the remaining time or distance before the next service due date.

You can hide this service message by using the back button on the left-hand side of the steering wheel.

You can obtain further information concerning the servicing of your vehicle from a qualified specialist workshop, e.g. a Mercedes-Benz service centre.

### Displaying the service due date

On-board computer:

→ Service ► ASSYST PLUS

The next service due date is displayed.

► **To exit the display:** press the back button on the left-hand side of the steering wheel.

Make sure to observe the following related subject:

- Operating the on-board computer (→ page 175).

### Carrying out maintenance work regularly

**NOTE** Premature wear through failure to observe service due dates

Service work which is not carried out at the right time or incompletely can lead to increased wear and damage to the vehicle.

- Always observe the prescribed service intervals.
- Always have the prescribed service work carried out at a qualified specialist workshop.

### Special service requirements

The prescribed service interval is based on normal vehicle use. Service work will need to be performed more often if the vehicle is operated under arduous conditions or increased loads, for example:

- regular city driving with frequent intermediate stops.

- if the vehicle is primarily used to travel short distances.
- for frequent operation in mountainous terrain or on poor road surfaces.
- if the engine is often left idling for long periods.
- in particularly dusty conditions, or if air-recirculation mode is frequently used.

In these or similar operating conditions, have the interior air filter, engine air cleaner, engine oil and oil filter, for example, changed more frequently. If the vehicle is subjected to higher loads, the tyres must be checked more frequently. Further information can be obtained at a qualified specialist workshop.

### Battery disconnection periods

**The ASSYST PLUS service interval display can only calculate the service due date when the battery is connected.**

- Note down the service due date displayed on the instrument display before disconnecting the battery (→ page 270).

## Engine compartment

### Opening and closing the bonnet

**WARNING** Risk of accident due to driving with the engine bonnet unlocked

An unlocked engine bonnet may open up when the vehicle is in motion and block your view.

- Never unlock the engine bonnet when driving.
- Before every trip, ensure that the engine bonnet is locked.

**WARNING** Danger of burns when opening the bonnet

If you open the engine bonnet when the engine has overheated or during a fire in the engine compartment, you could come into contact with hot gases or other escaping operating fluids.

- Before opening the bonnet, allow the engine to cool down.



- ▶ In the event of a fire in the engine compartment, keep the engine bonnet closed and call the fire service.

**⚠ WARNING** Risk of injury due to moving parts

Certain components in the engine compartment may continue to move or suddenly move again even after the ignition has been switched off, e.g. the cooler fan.

Make sure of the following before performing tasks in the engine compartment:

- ▶ Switch the ignition off.
- ▶ Never touch the danger zone surrounding moving component parts, e.g. the rotation area of the fan.
- ▶ Remove jewellery and watches.
- ▶ Keep items of clothing and hair away from moving parts.

**⚠ WARNING** Risk of injury from touching component parts under voltage

The ignition system and the fuel injection system work under high voltage. If you touch component parts which are under voltage, you could receive an electric shock.

- ▶ Never touch components of the ignition system or the fuel injection system when the ignition is switched on.

Live components of the fuel injection system include the injectors, for example.

Live components of the ignition system include the following, for example:

- ignition coils
- spark plug connectors
- diagnostic socket

**⚠ WARNING** Danger of burns from hot component parts in the engine compartment

Certain component parts in the engine compartment may be very hot, e.g. the engine, the radiator and parts of the exhaust system.

- ▶ Let the engine cool down and only touch the component parts described below:

If you have to carry out any work in the engine compartment, touch only the following components:

- bonnet
- engine oil filler opening cap
- washer fluid reservoir cap
- coolant expansion reservoir cap

**⚠ WARNING** Risk of injury from using the windscreen wipers while the engine bonnet is open

When the engine bonnet is open, and the windscreen wipers are set in motion, you can be trapped by the wiper linkage.

- ▶ Always switch off the windscreen wipers and ignition before opening the engine bonnet.

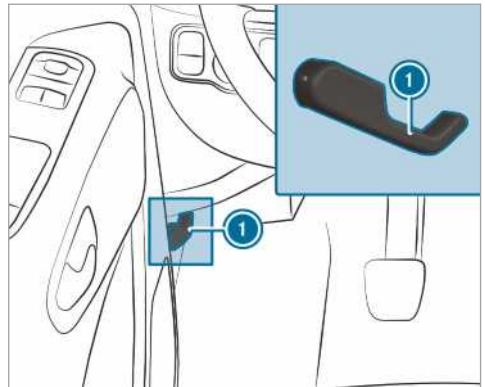

- ▶ Park the vehicle in a safe location and on a level surface if possible.
- ▶ Switch off the engine.
- ▶ Secure the vehicle against rolling away.

**⚠ WARNING** Risk of injury when the bonnet is opened

When you open the bonnet, it may suddenly drop into the end position.

There is a risk of injury to anyone in the bonnet's range of movement.

- ▶ Before releasing the bonnet, ensure that the support is firmly seated in the holder.
- ▶ Open the bonnet only when there is no one in the bonnet's range of movement.



- ▶ **To open:** pull handle ❶ to release the bonnet.
- ▶ Reach into the gap and push the bonnet catch handle upwards.
- ▶ Open the bonnet and hold it up.

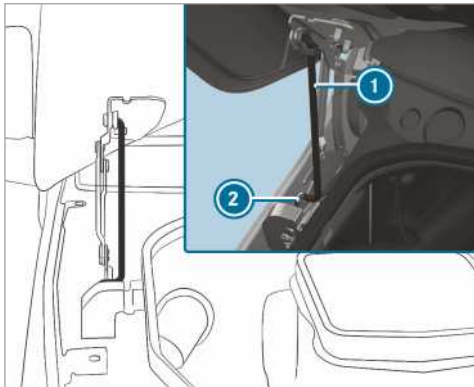

- ▶ Take support ❶ from the bracket on the bonnet and pull it downwards.
- ▶ Insert the support into the bracket below ❷.

**⚠ WARNING** Risk of fire due to flammable material in the engine compartment or the exhaust system

Cloths or other flammable materials left in the engine compartment by mistake could ignite upon coming into contact with hot sections of the engine or exhaust system.

- ▶ Ensure that there are no flammable external materials in the engine compartment or on the exhaust system after maintenance work has been conducted.

**⚠ WARNING** Risk of accident and injury when opening and closing the engine bonnet

When opening or closing the engine bonnet, it may suddenly drop into the end position.

There is a risk of injury for anyone in the engine bonnet's range of movement.

- ▶ Only open or close the engine bonnet when there are no persons in the engine bonnet's range of movement.

**!** **NOTE** Damage to the bonnet

Pushing the bonnet closed with your hands could damage it.

- ▶ To close the bonnet, let it drop from the specified height.

- ▶ **To close:** lift the bonnet slightly.
- ▶ Move support ❶ to the bracket on the bonnet and apply light pressure to engage it.
- ▶ Lower the bonnet and let it drop from a height of approximately 15 cm.
- ▶ If it is still possible to lift the bonnet a little, open the bonnet again and let it drop from a height of approximately 20 cm until it engages correctly.

## Engine oil

### Checking the engine oil level with an on-board computer

The engine oil level is determined when driving. Depending on the driving profile, the oil level can only be displayed after a driving time of up to 30 minutes and only when the ignition is switched on.

Correct measurement of the oil level is not possible in the following cases:

- the vehicle is not level.
- the bonnet was opened beforehand.

The engine must then be restarted and the engine oil level is measured when driving.

On-board computer:

➔ **Service** ➔ **Engine oil level:**

**You will see one of the following messages in the multifunction display:**

- ▶ **Engine oil level Measuring now:** measurement of the oil level not yet possible. Repeat the query after driving a maximum of 30 minutes.
- ▶ **Engine oil level OK** and the bar to display the oil level in the multifunction display is green and lies between "MIN" and "MAX": the oil level is OK.
- ▶ **Engine oil level Warm up the engine:** warm up the engine to operating temperature.
- ▶ **Engine oil level Correct measurement only if vehicle is on level ground:** park the vehicle on an even surface.

- ▶ **Motorölstand 1,0 l nachfüllen** and the bar to display the oil level in the multifunction display is orange and lies below "MIN": add 1 l of engine oil.
- ▶ **Reduce engine oil level** and the bar displaying the oil level in the multifunction display is orange and lies above "MAX": drain off excess engine oil. Visit a qualified specialist workshop.
- ▶ **For engine oil level switch on ignition**: switch on the ignition in order to check the engine oil level.
- ▶ **Engine oil level System inoperative**: sensor is defective or not connected. Visit a qualified specialist workshop.
- ▶ **Engine oil level currently inoperative**: close the bonnet.

**i** Vehicles with cold oil level displays: the oil level is automatically displayed in the multifunction display after a long vehicle non-operational time. If it is not possible to measure the engine oil level, a relevant message will appear.

### Topping up the engine oil

**⚠ WARNING** Danger of burns from hot component parts in the engine compartment

Certain component parts in the engine compartment may be very hot, e.g. the engine, the radiator and parts of the exhaust system.

- ▶ Let the engine cool down and only touch the component parts described below:

If you have to carry out any work in the engine compartment, touch only the following components:

- bonnet
- engine oil filler opening cap
- washer fluid reservoir cap
- coolant expansion reservoir cap

**⚠ WARNING** Risk of fire and injury from engine oil

If engine oil comes into contact with hot component parts in the engine compartment, it may ignite.

- ▶ Make sure that no engine oil is spilled next to the filler opening.
- ▶ Allow the engine to cool off and thoroughly clean the engine oil from component parts before starting the vehicle.

**!** **NOTE** Engine failure due to incorrect oil filter, incorrect oil or additive

- ▶ Do not use engine oil or an oil filter with specifications deviating from those required for the prescribed service intervals.

Mercedes-Benz recommends using original or tested replacement and service parts.

- ▶ Do not change the engine oil or oil filter in order to set replacement intervals longer than those prescribed.
- ▶ Do not use any additive.
- ▶ Follow the instructions on the service interval display for changing the engine oil.

**!** **NOTE** Damage caused by topping up too much engine oil

Topping up too much engine oil can cause damage to the engine or the catalytic converter.

- ▶ Have excess engine oil removed at a qualified specialist workshop.

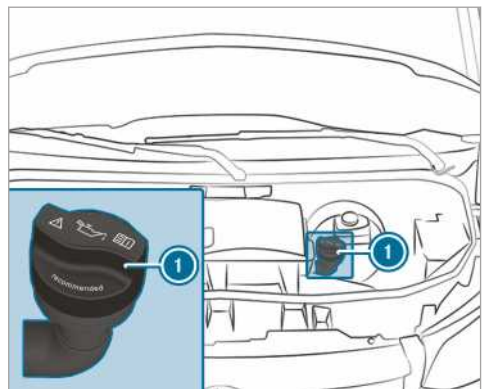

OM651

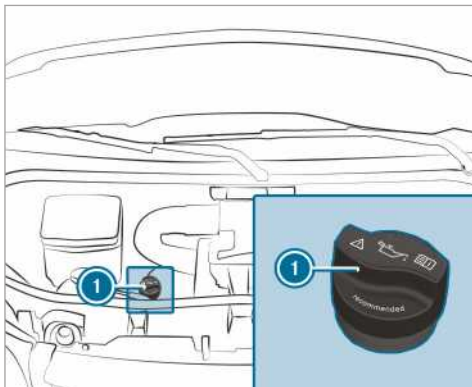

OM642

- ▶ Turn cap ① anti-clockwise and remove it.
- ▶ Top up the engine oil.
- ▶ Replace cap ① and turn it clockwise until it engages.
- ▶ Check the oil level again .

### Checking the coolant level

**⚠ WARNING** Danger of burns from hot component parts in the engine compartment

Certain component parts in the engine compartment may be very hot, e.g. the engine, the radiator and parts of the exhaust system.

- ▶ Let the engine cool down and only touch the component parts described below:

If you have to carry out any work in the engine compartment, touch only the following components:

- bonnet
- engine oil filler opening cap
- washer fluid reservoir cap
- coolant expansion reservoir cap

**⚠ WARNING** Danger of burns when opening the bonnet

If you open the engine bonnet when the engine has overheated or during a fire in the engine compartment, you could come into contact with hot gases or other escaping operating fluids.

- ▶ Before opening the bonnet, allow the engine to cool down.
- ▶ In the event of a fire in the engine compartment, keep the engine bonnet closed and call the fire service.

**⚠ WARNING** Risk of scalding from hot coolant

The engine cooling system is pressurised, particularly when the engine is warm. If you open the cap, you could be scalded by hot coolant spraying out.

- ▶ Let the engine cool down before opening the cap.
- ▶ When opening the cap, wear protective gloves and safety glasses.
- ▶ Open the cap slowly to release pressure.

**! NOTE** Paintwork damage due to coolant

If coolant gets on painted surfaces, the paintwork can be damaged.

- ▶ Add coolant carefully.
- ▶ Remove spilled coolant.

### Checking the coolant level

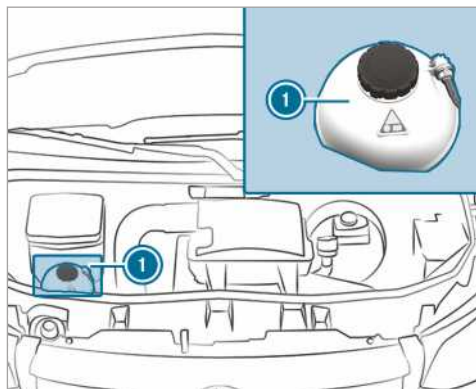

Example: coolant expansion reservoir

- ▶ Park the vehicle on an even surface.
- ▶ Open the bonnet (→ page 270).
- ▶ Slowly turn the coolant expansion reservoir cap ① half a turn anti-clockwise and allow excess pressure to escape.

- ▶ Turn coolant expansion reservoir cap ❶ further and remove it.
- ▶ Check the coolant level.  
There is enough coolant in coolant expansion reservoir if the coolant reaches the MAX mark.

### Topping up the coolant

- ▶ Refill the coolant to the MAX mark on the coolant expansion reservoir.

Only use coolant approved by Mercedes-Benz to avoid damaging the engine cooling system.

- ▶ Replace coolant expansion reservoir cap ❶ and tighten in a clockwise direction.
- ▶ Start the engine.
- ▶ After approximately five minutes, switch off the engine again and allow it to cool down.
- ▶ Check the coolant level again and top up the coolant if necessary.

❶ Further information on coolant (→ page 340)

### Filling up the windscreen washer system

**⚠ WARNING** Danger of burns from hot component parts in the engine compartment

Certain component parts in the engine compartment may be very hot, e.g. the engine, the radiator and parts of the exhaust system.

- ▶ Let the engine cool down and only touch the component parts described below:

If you have to carry out any work in the engine compartment, touch only the following components:

- bonnet
- engine oil filler opening cap
- washer fluid reservoir cap
- coolant expansion tank cap

**⚠ WARNING** Danger of burns when opening the bonnet

If you open the engine bonnet when the engine has overheated or during a fire in the engine compartment, you could come into contact with hot gases or other escaping operating fluids.

- ▶ Before opening the bonnet, allow the engine to cool down.
- ▶ In the event of a fire in the engine compartment, keep the engine bonnet closed and call the fire service.

**⚠ WARNING** - Risk of fire and injury due to windscreen washer concentrate

Windscreen washer concentrate is highly flammable. It could ignite if it comes into contact with hot engine component parts or the exhaust system.

- ▶ Make sure that no windscreen washer concentrate spills out next to the filler opening.

### Topping up the washer fluid

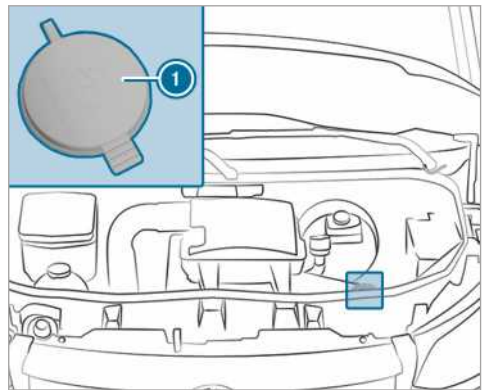

Washer fluid reservoir (example)

- ▶ Pre-mix the washer fluid in the correct mixing ratio in a container.
- ▶ Park the vehicle on a level surface and secure it against rolling away (→ page 140).
- ▶ Open the bonnet (→ page 270).
- ▶ Pull the cap of washer fluid container ❶ upwards by the strap.
- ▶ Pour in the pre-mixed washer fluid.
- ▶ Press cap ❶ onto the filler opening until it audibly engages.
- ▶ Close the bonnet (→ page 270).
- Further information about the windscreen washer fluid (→ page 340)

## Cleaning the water drain valve of the air intake box

### **⚠ WARNING** Risk of injury due to moving parts

Certain components in the engine compartment may continue to move or suddenly move again even after the ignition has been switched off, e.g. the cooler fan.

Make sure of the following before performing tasks in the engine compartment:

- ▶ Switch the ignition off.
- ▶ Never touch the danger zone surrounding moving component parts, e.g. the rotation area of the fan.
- ▶ Remove jewellery and watches.
- ▶ Keep items of clothing and hair away from moving parts.

### **⚠ WARNING** Danger of burns from hot component parts in the engine compartment

Certain component parts in the engine compartment may be very hot, e.g. the engine, the radiator and parts of the exhaust system.

- ▶ Let the engine cool down and only touch the component parts described below:

If you have to carry out any work in the engine compartment, touch only the following components:

- bonnet
- engine oil filler opening cap
- washer fluid reservoir cap
- coolant expansion reservoir cap

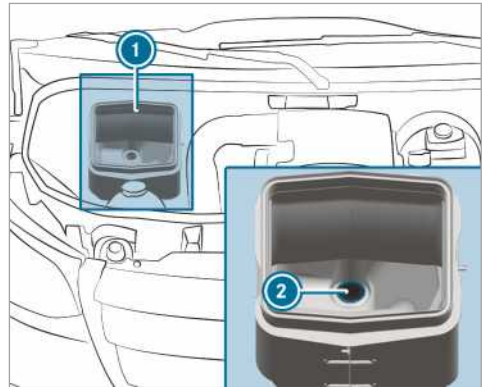

- ▶ Open the bonnet (→ page 270).
- ▶ Remove dirt from the water drain valve ② of the air intake box ①.

## Draining the fuel filter

### **⚠ WARNING** Danger of fire and explosion due to fuel

Fuels are highly flammable.

- ▶ It is essential to avoid fire, naked flames, smoking and creating sparks.
- ▶ Before filling up, switch off the engine, and, if applicable, the auxiliary heating.

### **⚠ WARNING** Risk of fire and explosion due to fuel

Fuels are highly flammable. There is a risk of fire and explosion due to contact with hot component parts.

- ▶ Allow the engine and the exhaust system to cool down.

### **!** **NOTE** Engine damage due to delayed drainage of the fuel filter

**Vehicles with a diesel engine:** delayed drainage of the fuel filter can lead to engine damage.

If the indicator lamp  lights up, drain the fuel filter immediately.

 **ENVIRONMENTAL NOTE** Environmental pollution due to disposal in a non-environmentally-friendly manner

- ▶ Dispose of the water/fuel mixture in an environmentally-friendly manner.

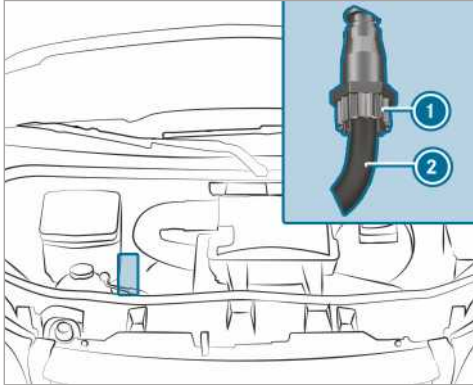

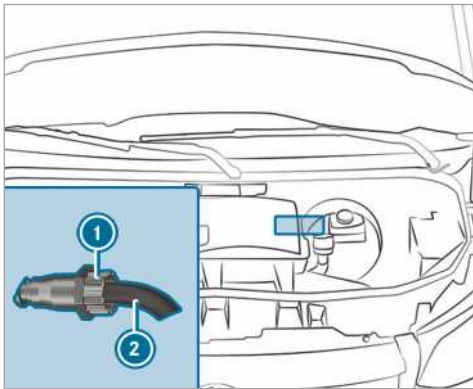

OM642

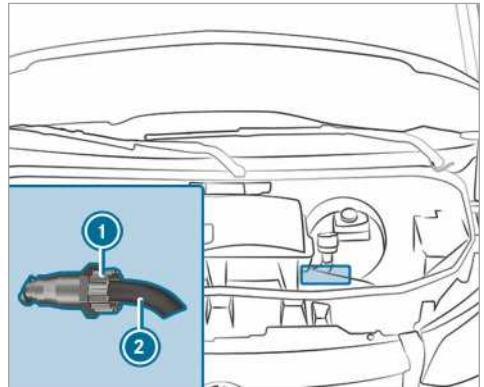

OM651 front wheel drive



OM651 rear wheel drive

- ▶ Park the vehicle in a safe location and secure it against rolling away.
- ▶ Switch off the auxiliary heating (→ page 104).
- ▶ Switch off the engine.
- ▶ Open the bonnet (→ page 270).
- ▶ Place a suitable collector beneath drain hose ②.
- ▶ Switch on the ignition.
- ▶ Open drain screw ① until the water/fuel mixture emerges from drain hose ②.
- ▶ Close drain screw ① as soon as around 0.2 litre of the water/fuel mixture has been collected.  
After 30 seconds, the electrical fuel pump automatically stops the discharge of the water/fuel mixture.
- ▶ After draining, switch off the ignition.
- ▶ Dispose of the collected water/fuel mixture in an environmentally friendly manner, e.g. at a qualified specialist workshop.
- ▶ Check that drain screw ① has been closed. If the engine is running while drain screw ① is open, you will lose fuel through drain hose ②.
- ▶ Close the bonnet (→ page 270).
- ▶  **The indicator lamp does not go out after draining:** drain the fuel filter again.
- ▶  **The indicator lamp does not go out after the second draining:** consult a qualified specialist workshop.

Mercedes-Benz recommends that you have the fuel filter drained at a qualified specialist workshop.

## Cleaning and care

### Notes on washing the vehicle in an automatic car wash

**▲ WARNING** Risk of an accident due to reduced braking power after washing the vehicle

Braking efficiency is reduced after washing the vehicle.

- ▶ After the vehicle has been washed, brake carefully while paying attention to the traffic conditions until braking power has been fully restored.

Make sure that the automatic car wash is suitable for the size of the vehicle.

Before washing the vehicle in an automatic car wash, fold in the outside mirrors and remove any additional aerials. Otherwise, the outside mirrors, aerial or the vehicle itself could be damaged.

Make sure any additional aerials are refitted and that the outside mirrors are fully folded out again when you leave the automatic car wash.

To avoid damage to your vehicle, observe the following before using an automatic car wash:

- the side windows and the sliding window are completely closed.
- the blower for ventilation and heating is switched off.
- the windscreen wiper switch is in position **0**.

If the vehicle is very dirty, wash off excess dirt before cleaning the vehicle in an automatic car wash.

- i** Removing the wax from the windscreen and the wiper rubbers after washing the vehicle, will help avoid smearing and reduce wiper noise.

### Notes on use of a high-pressure cleaner

**▲ WARNING** Risk of an accident when using high-pressure cleaners with circular jet nozzles

The water jet of a circular jet nozzle (dirt grinder) can cause externally invisible damage to the tyres or chassis parts.

Components damaged in this way may unexpectedly fail.

- ▶ Do not use high-pressure cleaners with circular jet nozzles to clean the vehicle.
- ▶ Have damaged tyres or chassis parts replaced immediately.

Never use a high-pressure cleaner in the vehicle interior. The pressurised water created by the high-pressure cleaner and the associated spray could cause considerable damage to the vehicle.

To avoid damage to your vehicle, observe the following when using a high-pressure cleaner:

- maintain a minimum distance of 30 cm to the vehicle when using 25° flat-spray nozzles and dirt grinders or 70 cm when using round-spray nozzles and observe the information in the equipment manufacturer's operating instructions.
- do not direct the nozzle of the high-pressure cleaner directly at sensitive parts such as tyres, slits, electrical components, batteries, light bulbs and ventilation slits.
- maintain a minimum distance of 50 cm for a reversing camera.

### Washing the vehicle by hand

Observe the legal requirements, for example in many countries washing by hand is only allowed at specially designated wash bays.

- ▶ Use a mild cleaning agent, e.g. car shampoo.
- ▶ Wash the vehicle with lukewarm water and a soft car sponge. When doing so, do not expose the vehicle to direct sunlight.
- ▶ Carefully spray the vehicle with water and dry off with a leather cloth. Be careful not to point the water jet directly towards the air inlet grilles. The blower should be switched off while doing so.
- ▶ Do not let the cleaning agent dry on the paintwork.

At the onset of winter, remove all traces of road salt deposits carefully and as soon as possible.

### Notes on care of paint and matt finish

**!** **NOTE** Paintwork damage and corrosion due to inadequate care

Failure to promptly and thoroughly remove dirt from bird droppings or other residue



could result in paintwork damage and corrosion at a later date.

▶ Clean dirt off paint and matt finish thoroughly and as soon as possible.

### Observe the following notes:

	Notes on cleaning and care	Avoiding paintwork damage
<b>Paint</b>	<ul style="list-style-type: none"> <li>• Insect remains: soak with insect remover and then wash off.</li> <li>• Bird droppings: soak with water and then wash off.</li> <li>• Remove coolant, tree resin, oils, fuels and greases: rub gently with a cloth soaked in petroleum ether or lighter fluid.</li> <li>• Brake fluid: wash off with water.</li> <li>• Tar stains: use tar remover.</li> <li>• Wax: use a silicone remover.</li> </ul>	<ul style="list-style-type: none"> <li>• Do not affix stickers, films or similar.</li> <li>• Remove dirt as soon as possible.</li> </ul>
<b>Matt finish</b>	<ul style="list-style-type: none"> <li>• Only use care products approved by Mercedes-Benz.</li> </ul>	<ul style="list-style-type: none"> <li>• Do not polish the vehicle and light-alloy wheels.</li> <li>• Do not use a wash program that ends with a hot wax treatment in automatic car washes.</li> <li>• Do not use paint cleaners, buffing or polishing products, or gloss preservers, e.g. wax.</li> <li>• Have paint repairs carried out in a qualified specialist workshop only.</li> </ul>

### Notes on the care of vehicle parts

**⚠ WARNING** Risk of entrapment if the windscreen wipers are switched on while the windscreen is being cleaned

If the windscreen wipers are set in motion while you are cleaning the windscreen or wiper blades, you can be trapped by the wiper arm.

▶ Always switch off the windscreen wipers and the ignition before cleaning the windscreen or wiper blades.

**⚠ WARNING** Risk of burning from the tailpipe or tailpipe trim

The tailpipe and tailpipe trim can become very hot. If you come into contact with these car parts, you could burn yourself.

▶ Always be particularly careful when in the vicinity of the tailpipe and tailpipe trims and supervise children very closely when in this area.

▶ Before any contact, allow the car parts to cool down.



## Observe the following notes:

	Notes on cleaning and care	Preventing damage to the vehicle
<b>Wheels/rims</b>	Use water and acid-free wheel cleaner.	<ul style="list-style-type: none"> <li>Do not use acidic wheel cleaners to remove brake dust. Otherwise, wheel bolts and brake components may be damaged.</li> <li>To avoid corrosion of brake discs and brakepads, drive for a few minutes after cleaning before parking the vehicle. The brake discs and brakepads warm up and dry out.</li> </ul>
<b>Windows</b>	Clean windows inside and outside with a damp cloth and with a cleaning agent recommended by Mercedes-Benz.	Do not use dry cloths or cleaning agents which are abrasive or solvent-based to clean the inside of windows.
<b>Wiper blades</b>	Carefully clean the folded-away wiper blades with a damp cloth.	Do not clean the wiper blades too often.
<b>Exterior lighting</b>	Clean the lenses with a wet sponge and mild cleaning agent, e.g. car shampoo.	Only use cleaning agents or cloths suitable for plastic lenses.
<b>Sensors</b>	Clean the sensors in the front and rear bumper and in the radiator grille with a soft cloth and car shampoo.	When using a high-pressure cleaner, keep a minimum distance of 30 cm.
<b>Reversing camera and 360° Camera</b>	Use clean water and a soft cloth to clean the camera lens.	Do not use a high-pressure cleaner.
<b>Trailer hitch</b>	<ul style="list-style-type: none"> <li>Remove traces of rust on the ball, e.g. with a wire brush.</li> <li>Remove dirt with a lint-free cloth.</li> <li>After cleaning, lightly oil or grease the ball head.</li> <li>Observe the notes on care in the trailer hitch manufacturer's operating instructions.</li> </ul>	Do not clean the ball neck with a high-pressure cleaner or solvent.
<b>Sliding door</b>	<ul style="list-style-type: none"> <li>Remove foreign objects from the vicinity of the contact plates and contact pins of the sliding door.</li> <li>Clean the contact plates and contact pins with a mild cleaning agent and a soft cloth.</li> </ul>	Do not oil or grease the contact plates and the contact pins.

	Notes on cleaning and care	Preventing damage to the vehicle
<b>Steps</b>	<ul style="list-style-type: none"> <li>• Clean the electrically operated steps and their housing with a high-pressure cleaner.</li> <li>• After cleaning, spray the lateral guides with silicone spray.</li> <li>• Clean the steps in the bumper with a high-pressure cleaner.</li> </ul>	Do not use oil or grease as a lubricant.
<b>Aluminium dropsides</b>	<ul style="list-style-type: none"> <li>• Brush down the aluminium dropsides with water and a neutral or mild alkaline cleaning agent.</li> </ul>	Do not use abrasive cleaning agents to clean the dropsides.

### Notes on interior care

**⚠ WARNING** Risk of injury from plastic parts breaking off after the use of solvent-based care products

Care and cleaning products containing solvents can cause surfaces in the cockpit to become porous.

When the airbags are deployed, plastic parts may break away.

▶ Do not use any care or cleaning products containing solvents to clean the cockpit.

**⚠ WARNING** Risk of injury or death from bleached seat belts

Bleaching or dyeing seat belts can severely weaken them.

This can, for example, cause seat belts to tear or fail in an accident.

▶ Never bleach or dye seat belts.

### Observe the following notes:

	Notes on cleaning and care	Preventing damage to the vehicle
<b>Seat belts</b>	Clean with lukewarm soapy water.	<ul style="list-style-type: none"> <li>• Do not use chemical cleaning agents.</li> <li>• Do not dry the seat belt by heating above 80 °C or in direct sunlight.</li> </ul>
<b>Display</b>	Clean the surface carefully with a micro-fibre cloth and TFT/LCD display care product.	<ul style="list-style-type: none"> <li>• Switch off the display and let it cool down.</li> <li>• Do not use any other agents.</li> </ul>
<b>Plastic trim</b>	<ul style="list-style-type: none"> <li>• Clean with a damp microfibre cloth.</li> <li>• For heavy soiling: use a care product recommended by Mercedes-Benz.</li> </ul>	<ul style="list-style-type: none"> <li>• Do not affix stickers, films or similar.</li> <li>• Do not allow to come into contact with cosmetics, insect repellent and sun creams.</li> </ul>
<b>Real wood/trim elements</b>	<ul style="list-style-type: none"> <li>• Clean with a microfibre cloth.</li> <li>• Black piano-lacquer look: clean with a damp cloth and soapy water.</li> <li>• For heavy soiling: use a care product recommended by Mercedes-Benz.</li> </ul>	Do not use solvent-based cleaning agents, polishes or waxes.

	Notes on cleaning and care	Preventing damage to the vehicle
<b>Roof lining</b>	Clean with a soft brush or dry shampoo.	
<b>Cloth seat covers</b>	Vacuum up dirt such as crumbs or dust and then use a damp microfibre cloth and a 1% soapsuds solution to clean the entire seat cover. Do not spot-clean. Use cleaning and care products recommended by Mercedes-Benz.	Do not use any oil-based cleaning and care products.
<b>Artificial leather seat covers</b>	Vacuum up dirt such as crumbs or dust and then use a damp cotton cloth and a 1% soapsuds solution to clean the entire seat cover. Do not spot-clean. Use cleaning and care products recommended by Mercedes-Benz.	Do not use a microfibre cloth. Do not use any oil-based cleaning and care products.
<b>Genuine leather seat covers</b>	Regularly vacuum up dirt such as crumbs or dust and then use a damp cotton cloth to clean the entire seat covers. For heavy soiling: use a leather care agent recommended by Mercedes-Benz for aftertreatment.	Do not use a microfibre cloth. Do not use any oil-based cleaning and care products.
<b>Steering wheel and gear or selector lever</b>	Clean with a damp cloth.	
<b>Pedals and floor mats</b>	Clean with a damp cloth.	Do not use any cleaning and care products.
<b>Vehicle interior</b>	Clean with a damp cloth.	<ul style="list-style-type: none"> <li>• Do not use a high-pressure cleaner.</li> <li>• Allow the vehicle interior to dry completely after cleaning.</li> <li>• Do not allow liquids to penetrate into gaps or cavities.</li> </ul>
<b>Curtains</b>	The curtains may only be dry cleaned.	Do not wash the curtains.

## Emergency

### Removing the safety vest

The safety vest is located in the stowage compartment in the driver's door.

- ▶ Remove the safety vest from the stowage compartment.
- ❶ Safety vests can also be stored in the stowage compartments of the rear doors and the co-driver's door.

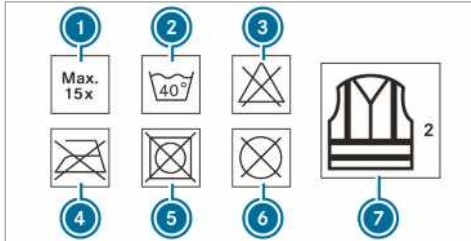

- ❶ Maximum number of washes
- ❷ Maximum wash temperature
- ❸ Do not bleach
- ❹ Do not iron
- ❺ Do not tumble dry
- ❻ Do not dry-clean
- ❼ This is a class 2 vest

The safety vest only fulfils the legally required standards if it is the correct size and is completely closed.

Replace the safety vest:

- if damaged or if the reflex strips are dirty
- if the maximum permitted number of washes is exceeded
- if the safety vest's fluorescence has faded

### Warning triangle

#### Removing the warning triangle

The warning triangle is located in the stowage compartment in the front passenger door.

- ▶ Take warning triangle out of the stowage compartment.

### Setting up the warning triangle

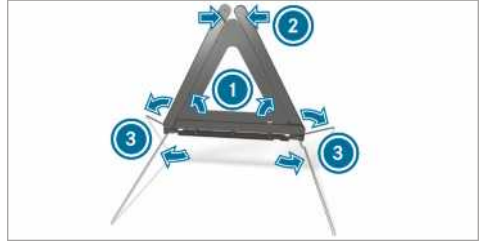

- ▶ Fold side reflectors ❶ upwards to form a triangle and lock them at the top using the upper press-stud ❷.
- ▶ Fold stand ❸ down and out to the side.

### First-aid kit (soft-sided)

The first-aid kit (soft sided) is located in the stowage compartment in the front passenger door.

- ▶ Remove first-aid (soft sided) kit from the stowage compartment.

### Removing and stowing fire extinguishers

**⚠ WARNING** Risk of accident due to an incorrectly secured fire extinguisher in the driver's footwell

A fire extinguisher in the driver's footwell may impede pedal travel or block a depressed pedal.

This jeopardises the operating and road safety of the vehicle.

Moreover, the fire extinguisher can be flung around in the driver's footwell and injure the driver or other vehicle occupants.

Always store and secure the fire extinguisher in the bracket during the journey.

Do not remove the fire extinguisher while driving.

## Removing

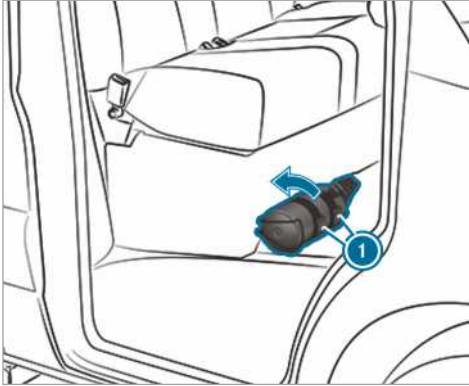

- ▶ Pull the tabs on the bracket of fire extinguisher ① upwards.
- ▶ Remove the fire extinguisher.

## Stowing

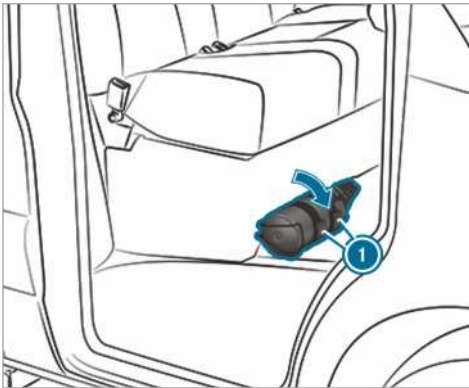

- ▶ Stow the fire extinguisher.
  - ▶ Push the tabs on the bracket of fire extinguisher ① downwards.
- ① In a right-hand-drive vehicle, the fire extinguisher is located on the co-driver's seat on the left when viewed in the direction of travel.

## Flat tyre

### Notes on flat tyres

- ⚠ **WARNING** Risk of an accident when driving with a flat tyre

A flat tyre greatly impairs driving characteristics, as well as steering and braking.

- ▶ Do not drive with a flat tyre.
- ▶ Remove the flat tyre and fit the spare wheel or consult a qualified specialist workshop.

In the event of a flat tyre you have the following possibilities depending on your vehicle's equipment:

- **Vehicles with Mercedes PRO connect:** in the event of a flat tyre, you can call breakdown assistance via the Service call button in the overhead control panel (→ page 246).
- **All vehicles:** change the wheel (→ page 321).

## Battery

### Notes on the 12 V battery

- ⚠ **WARNING** Risk of an accident due to work carried out incorrectly on the battery

Work carried out incorrectly on the battery can, for example, lead to a short circuit. This can lead to function restrictions in safety-relevant systems, e.g. the lighting system, ABS (anti-lock braking system) or ESP® (Electronic Stability Program). The operating safety of your vehicle may be restricted.

You could lose control of the vehicle in the following situations:

- when braking
  - in the event of abrupt steering manoeuvres and/or when the vehicle's speed is not adapted to the road conditions
- ▶ In the event of a short circuit or a similar incident, contact a qualified specialist workshop immediately.
  - ▶ Do not continue driving.
  - ▶ Always have work on the battery carried out at a qualified specialist workshop.

- Further information on ABS (→ page 146)
- Further information on ESP® (→ page 147)

Mercedes-Benz recommends that you have the 12 V battery replaced at a qualified specialist workshop, e.g. at a Mercedes-Benz Service Centre.

Should you want to replace the battery yourself, observe the following information:

- Always replace a faulty battery with a battery which fulfils the vehicle's specific requirements.
- Use detachable parts such as the breather hose, elbow fitting or terminal cover from the battery to be replaced.
- Make sure that the vent hose is always connected to its original opening on the battery side.

Fit the existing or newly supplied stop plugs. Otherwise, gases or battery acid could escape.

- Make sure that the detachable parts are connected in the same way as before.

For safety reasons, Mercedes-Benz recommends that you only use batteries that have been tested and approved for your vehicle by Mercedes-Benz. These batteries provide increased impact protection to prevent vehicle occupants from suffering acid burns should the battery be damaged in an accident.

**⚠ WARNING** Risk of explosion due to electrostatic charge

Electrostatic charge can cause sparks which may ignite the highly flammable gas mixture in the battery.

- ▶ To discharge any electrostatic charge that may have built up, touch the metal vehicle body before handling the battery.

The highly flammable gas mixture is created while the battery is charging and when jump-starting.

**⚠ WARNING** Danger of chemical burns from the battery acid

Battery acid is caustic.

- ▶ Avoid contact with the skin, eyes or clothing.
- ▶ Do not lean over the battery.

- ▶ Do not inhale battery gases.
- ▶ Keep children away from the battery.
- ▶ Immediately rinse battery acid off thoroughly with plenty of clean water and seek medical attention immediately.

**🔥 ENVIRONMENTAL NOTE** Environmental damage due to improper disposal of batteries



Batteries contain pollutants. It is illegal to dispose of them with the household rubbish.



Dispose of batteries in an environmentally responsible manner. Take discharged batteries to a qualified specialist workshop or to a collection point for used batteries.

If the 12 V battery has to be connected, contact a qualified specialist workshop.

Observe the safety notes and protective measures when handling batteries.



Risk of explosion



Fire, naked flames and smoking are prohibited when handling the battery. Avoid creating sparks.



Electrolyte or battery acid is corrosive. Avoid contact with the skin, eyes and clothing. Wear suitable protective clothing, in particular gloves, an apron and a safety mask. Immediately rinse electrolyte acid splashes off with clean water. If necessary, seek medical advice.



Wear eye protection.



Keep children at a safe distance.



Observe these Operating Instructions.

If you do not use the vehicle for a long period or drive short distances regularly:

- connect the battery to a charger recommended by Mercedes-Benz
- consult a qualified specialist workshop to disconnect the battery

### Starting assistance and charging the 12 V battery

▶ Always use the jump-start connection point in the engine compartment when charging the battery and jump-starting.

**!** **NOTE** Damaging the battery through overvoltage

When using a battery charger without a maximum charging voltage, the battery or the vehicle electronics may be damaged.

- ▶ Only use battery chargers with a maximum charging voltage of 14.8 V.

**!** **WARNING** Risk of explosion from hydrogen gas igniting

A battery generates hydrogen gas during the charging process. If there is a short circuit or sparks start to form, there is a danger of the hydrogen gas igniting.

- ▶ Make sure that the positive terminal of the connected battery does not come into contact with vehicle parts.
- ▶ Never place metal objects or tools on a battery.
- ▶ When connecting and disconnecting the battery, you must observe the described order for the battery clamps.
- ▶ When giving starting assistance, always make sure that you only connect battery terminals with identical polarity.
- ▶ During starting assistance, you must observe the described order for con-

necting and disconnecting the jump lead.

- ▶ Do not connect or disconnect the battery clamps while the engine is running.

**!** **WARNING** Risk of explosion during charging process and starting assistance

During the charging process and starting assistance, the battery may release an explosive gas mixture.

- ▶ Avoid fire, naked flames, creating sparks and smoking.
- ▶ Make sure that there is sufficient ventilation during the charging process and during starting assistance.
- ▶ Do not lean over a battery.

**!** **WARNING** Risk of explosion from a frozen battery

A discharged battery may freeze at temperatures slightly above or below freezing point.

During starting assistance or battery charging, battery gas may be released.

- ▶ Always thaw a frozen battery out first before charging it or performing starting assistance.

If the warning/indicator lamps do not light up in the instrument display around or below freezing point, it is very likely that the discharged battery has frozen.

In this case, observe the following points:

- do not give the vehicle starting assistance or charge the battery
- the service life of a battery that has been thawed may be reduced drastically
- the start-up behaviour may deteriorate, particularly at low temperatures
- it is recommended that you have a thawed battery checked at a qualified specialist workshop

**!** **NOTE** Damage caused by numerous or extended attempts to start the engine

Numerous or extended attempts to start the engine may damage the catalytic converter due to non-combusted fuel.

- ▶ Avoid numerous and extended attempts to start the engine.

When giving or receiving starting assistance and charging the battery, observe the following points:

- only use undamaged jump leads/charging cables with a sufficient cross-section and insulated terminal clamps
- non-insulated parts of the terminal clamps must not come into contact with other metal parts while the jump leads/charging cables are connected to the battery/jump-start connection point
- the jump leads/charging cable must not come into contact with any parts which may move when the engine is running
- always make sure that neither you nor the battery is electrostatically charged
- always keep away from fire and naked flames
- do not lean over a battery
- **When charging:** only use a battery charger that has been tested and approved by Mercedes-Benz and read the operating instructions for your charger before charging the battery.

Also observe the following points, when giving or receiving starting assistance:

- only give the vehicle starting assistance using batteries with a nominal voltage of 12 V
- the vehicles must not touch each other
- ▶ **Vehicles with a battery main switch:** check whether the battery main switch is switched on (→ page 122).
- ▶ Secure the vehicle using the parking brake.
- ▶ **Vehicles with automatic transmission:** shift the transmission to position **[P]**.
- ▶ **Vehicles with manual transmission:** shift to neutral.
- ▶ Switch off the ignition and all electrical consumers.
- ▶ Open the bonnet (→ page 270).

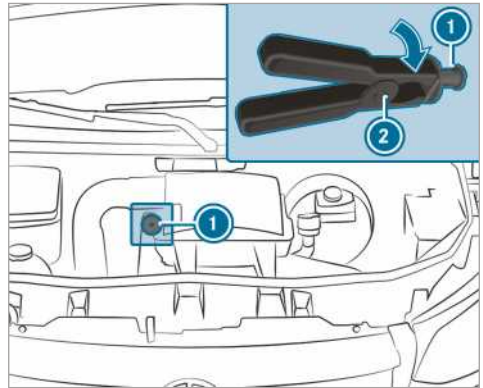

Jump-starting connection point (example)

- ▶ **i Right-hand-drive vehicles:** the jump-starting connection points may be on the opposite side.
- ▶ Remove the cover from the positive terminal on the donor battery.
- ▶ First, connect the positive terminal clamp of the jump leads/charging cables to the positive terminal of the other vehicle's battery.
- ▶ With positive terminal clamp ② of the jump lead, slide the red protective cap on jump-starting connection point ① back with a clockwise turn.
- ▶ Connect the positive terminal clamp to the positive terminal of jump-starting connection point ①.
- ▶ **When giving or receiving starting assistance:** start the engine of the donor vehicle and let it run at idle speed.
- ▶ Connect the negative terminal of the donor battery to the earth point of your own vehicle with the jump lead/charging cable. Begin with the donor battery.
- ▶ **When giving or receiving starting assistance:** start the engine on your own vehicle.
- ▶ **When charging:** start the charging process.
- ▶ **When giving or receiving starting assistance:** let the engine run for a few minutes.
- ▶ **When giving or receiving starting assistance:** before disconnecting the jump lead, switch on an electrical consumer on your own vehicle, e.g. the rear window heater or lighting.



When the starting assistance/charging process is complete:

- ▶ First, remove the jump leads/charging cables from the earth point and negative terminal of the other vehicle's battery, then from the positive terminal of jump-starting connection point ① and the positive terminal of the other vehicle's battery. Each time, begin at the contacts on your own vehicle.  
The red protective cap springs back to its initial position when positive terminal clamp ② is disconnected from jump-starting connection point ①.

Further information can be obtained at a qualified specialist workshop.

### Fitting and removing the floor covering (vehicles with rear-wheel drive)

**▲ WARNING** Risk of accident due to objects in the driver's footwell

Objects in the driver's footwell may impede pedal travel or block a depressed pedal.

This jeopardises the operating and road safety of the vehicle.

- ▶ Stow all objects in the vehicle securely so that they cannot get into the driver's footwell.
- ▶ Ensure floor mats and carpets cannot slip and provide sufficient room for the pedals.
- ▶ Do not lay multiple floor mats or carpets on top of one another.

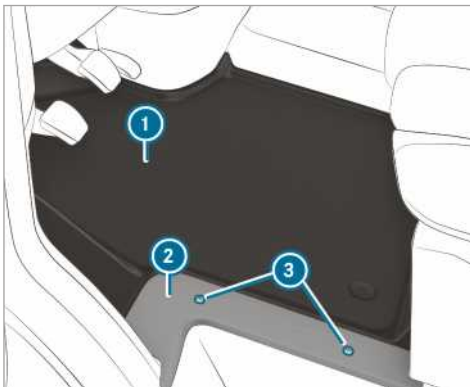

- ▶ Switch off all electrical consumers.

- ▶ **To remove:** remove screws ③ and take off trim ②.
- ▶ Remove floor covering ①.
- ▶ **To fit:** insert floor covering ① and align it at the base of the driver's seat and at the door sill.
- ▶ Put trim ② in place and screw screws ③ back in.

### Disconnecting the starter battery

**!** **NOTE** Damage to the electrical assembly

If you disconnect the starter battery before you have switched off the engine and removed the key from the ignition lock, electrical assemblies could be damaged.

- ▶ Switch off the engine and remove the key from the ignition lock. Then remove the battery terminals from the starter battery. Make sure you always disconnect the starter battery in the battery case in the left-hand footwell first. Otherwise, electrical assemblies, e.g. the alternator, could be damaged.

**!** **NOTE** Damage to the vehicle's electronics

If you do not disconnect the battery as described here, the vehicle's electronics could be damaged.

- ▶ Always disconnect the starter battery in following the sequence, and do not reverse the battery terminals under any circumstances. Otherwise, the vehicle's electronics could be damaged.

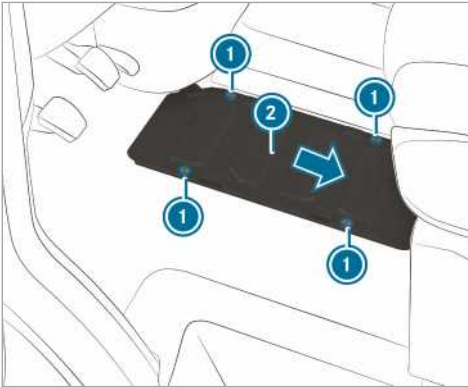

Vehicles with rear wheel drive

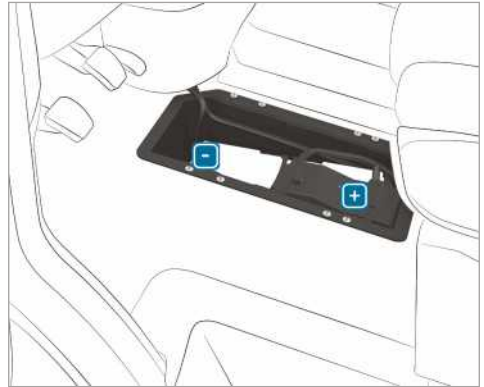

- ▶ First loosen and remove the negative terminal clamp on the battery so that the clamp is no longer in contact with the terminal.
- ▶ Remove the positive terminal clamp cover.
- ▶ Loosen the positive terminal clamp and fold it up to the side, together with the perfuse box.

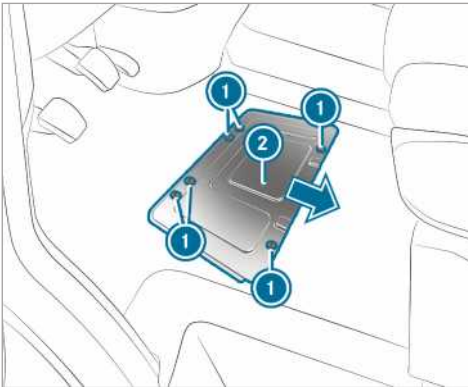

Vehicles with front wheel drive

If the vehicle is expected to be parked up or out of use for over three weeks, disconnect the batteries. This will prevent battery discharge caused by quiescent current consumers.

- ▶ **Vehicles with a battery main switch:** switch off the main switch of the battery .
- ▶ **Vehicles without a battery main switch:** switch off all electrical consumers.
- ▶ Switch off the engine and the power supply.
- ▶ Remove the floor covering (→ page 288).
- ▶ Remove screws ① and slide battery cover ② in the direction of the arrow.
- ▶ The screws must protrude over the larger recesses.
- ▶ Remove battery cover ② upwards.

### Removing/fitting the starter battery

#### Vehicles with rear wheel drive: removing the starter battery



- ▶ Disconnect the starter battery (→ page 288).
- ▶ Remove breather hose ① with the connector bracket from the connection on the degassing cover.

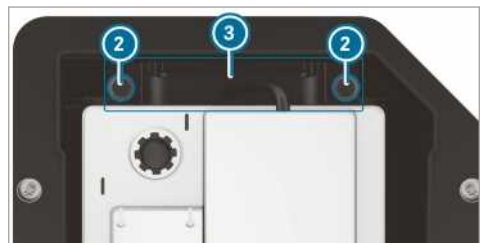

- ▶ Pull out and remove screws ② of bracket ③ upwards.
- ▶ Slide the starter battery from its anchorage in the direction of travel.
- ▶ Fold the bars of the starter battery upwards and remove the starter battery from the battery compartment.

**Vehicles with rear wheel drive: fitting the starter battery**

- ▶ When reconnecting the starter battery, observe the safety measures and protection notes (→ page 286).

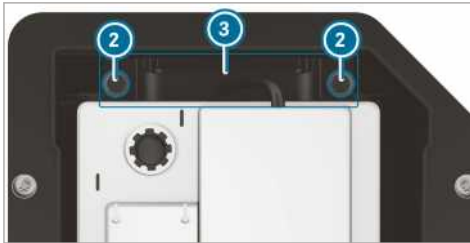

- ▶ Insert the starter battery into the battery compartment.
- ▶ Fold down the bars of the starter battery.
- ▶ Slide the starter battery into its anchorage in the opposite direction to the direction of travel.
- ▶ Insert bracket ③.
- ▶ Tighten screws ② on bracket ③ which holds the battery in place.



- ▶ Attach breather hose ① with the connector bracket to the connection of the ventilation cover.
- ▶ Reconnect the starter battery (→ page 288).

Mercedes-Benz recommends you have the battery replaced at a qualified specialist workshop, e.g. a Mercedes-Benz Service Centre.

If you want to replace the starter battery yourself, observe the following notes:

- Always replace a defective starter battery with a starter battery which meets the specific requirements of the vehicle.
- Use attachments such as the breather hose, angle piece or terminal cover of the starter battery to be replaced.
- Make sure that the vent hose is always connected to its original opening on the battery side.

Fit the existing or newly supplied stop plugs.

Otherwise, gases or battery acid could escape.

- Make sure that the detachable parts are connected in the same way as before.

**Vehicles with front wheel drive: removing the starter battery**

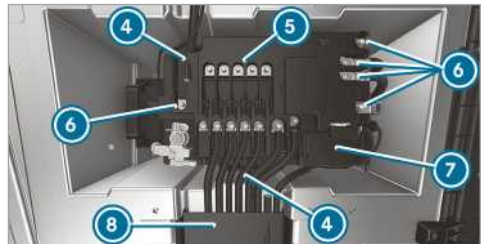

- ▶ Disconnect the starter battery (→ page 288).
- ▶ Open the flap on cable duct ⑧.
- ▶ Open the cover of positive pole ⑦.

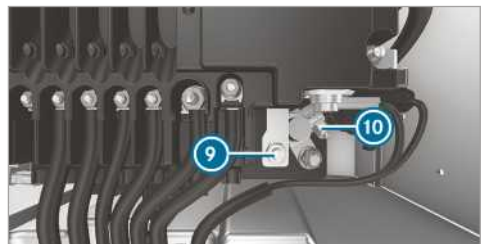

- ▶ Release nut ⑨ and positive pole ⑩.
- ▶ Unscrew nuts ⑥ of the wires, remove the wires and put them aside.
- ▶ Spread out catch tabs ④ on the prefuse box.
- ▶ Lift the prefuse box off the battery and slide it towards the front right.
- ▶ Fold the prefuse box upwards and to the rear.



- ▶ Remove breather hose ① with the connector bracket from the connection on the degassing cover.

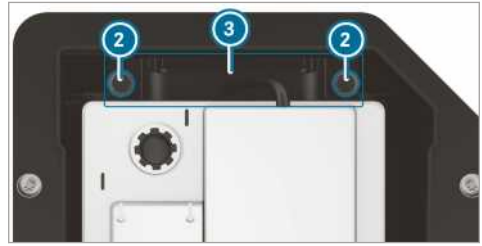

- ▶ Insert bracket ③.
- ▶ Tighten bolts ② on bracket ③ which holds the battery in place.

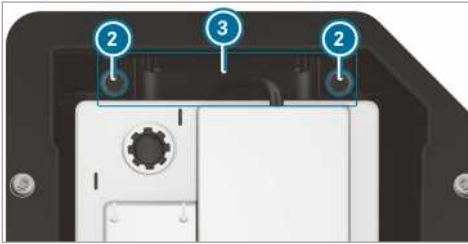

- ▶ Unscrew bolts ② of bracket ③ and pull the bracket out upwards.
- ▶ Slide the starter battery from its anchorage across the direction of travel.
- ▶ Fold the bars of the starter battery upwards and lift the starter battery out of the battery compartment.



- ▶ Attach breather hose ① with the connector bracket to the connection of the ventilation cover.
- ▶ Place the prefuse box on the battery.

### Vehicles with front wheel drive: fitting the starter battery

- ▶ When reconnecting the starter battery, observe the safety measures and protection notes (→ page 286).
- ▶ Insert the starter battery into the battery compartment.
- ▶ Take care that no wires are trapped.
- ▶ Fold down the bars of the starter battery.
- ▶ Slide the starter battery into its anchorage across the direction of travel.

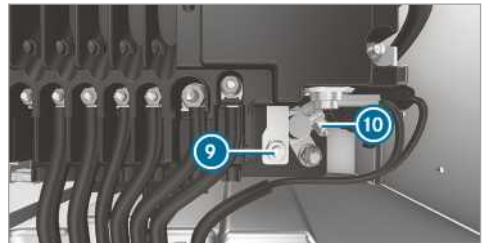
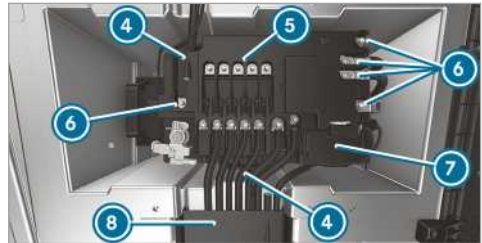

- ▶ Connect positive pole ⑩ and close cover ⑦.
- ▶ Place the wires on the support bolt.

- ▶ Tighten nuts ④ for the wires with torque ⑤ specified on the prefuse box.

Mercedes-Benz recommends that you have the battery replaced at a qualified specialist workshop, e.g. a Mercedes-Benz Service Centre.

If you want to replace the starter battery yourself, observe the following notes:

- Always replace a defective starter battery with a starter battery which meets the specific requirements of the vehicle.
- Use attachments such as the breather hose, angle piece or terminal cover of the starter battery to be replaced.
- Make sure that the vent hose is always connected to its original opening on the battery side.  
Fit the existing or newly supplied stop plugs. Otherwise, gases or battery acid could escape.
- Make sure that the detachable parts are connected in the same way as before.

### Disconnecting the auxiliary battery in the engine compartment

#### ! NOTE Damage to the electrical assembly

If you disconnect the starter battery before you have switched off the engine and removed the key from the ignition lock, electrical assemblies could be damaged.

- ▶ Switch off the engine and remove the key from the ignition lock. Then remove the battery terminals from the starter battery. Make sure you always disconnect the starter battery in the battery case in the left-hand footwell first. Otherwise, electrical assemblies, e.g. the alternator, could be damaged.

#### ! NOTE Damage to the vehicle's electronics

If you do not disconnect the auxiliary battery as described here, the vehicle's electronics could be damaged.

- ▶ Always disconnect the auxiliary battery in the following sequence, and do not reverse the battery terminals under any circumstances! Otherwise, the vehicle's electronics could be damaged.

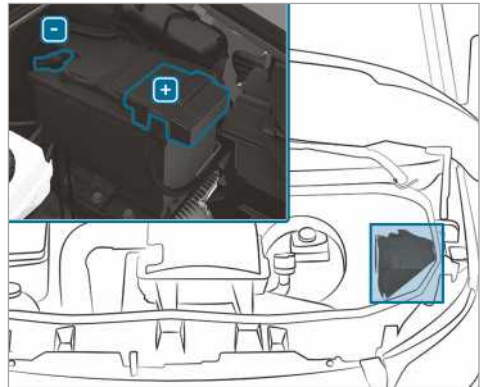

- ▶ Observe the safety measures and protection notices when disconnecting the auxiliary battery (→ page 286).
- ▶ Switch off all electrical consumers.
- ▶ Switch off the engine and the power supply.
- ▶ Open the bonnet (→ page 270).
- ▶ First loosen and remove the negative terminal clamp on the auxiliary battery so that the clamp is no longer in contact with the terminal.
- ▶ Remove the positive terminal clamp cover.
- ▶ Loosen and remove the positive terminal clamp.

### Disconnecting the auxiliary battery under the co-driver's bench seat

#### ! NOTE Damage to the electrical assembly

If you disconnect the starter battery before you have switched off the engine and removed the key from the ignition lock, electrical assemblies could be damaged.

- ▶ Switch off the engine and remove the key from the ignition lock. Then remove the battery terminals from the starter battery. Make sure you always disconnect the starter battery in the battery case in the left-hand footwell first. Otherwise, electrical assemblies, e.g. the alternator, could be damaged.

**!** **NOTE** Damage to the vehicle's electronics

If you do not disconnect the auxiliary battery as described here, the vehicle's electronics could be damaged.

- ▶ Always disconnect the auxiliary battery in the following sequence, and do not reverse the battery terminals under any circumstances! Otherwise, the vehicle's electronics could be damaged.

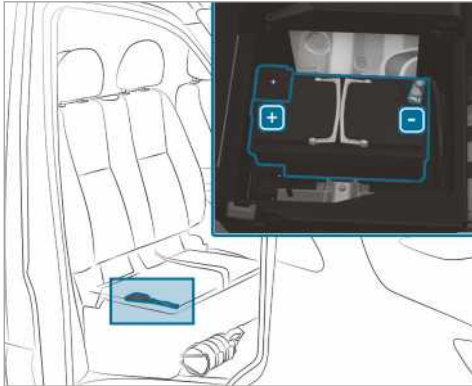

- ▶ Observe the safety measures and protection notices when disconnecting the auxiliary battery (→ page 286).
  - ▶ Switch off all electrical consumers.
  - ▶ Switch off the engine and switch off the power supply.
  - ▶ Fold the co-driver's bench seat cushion up (→ page 67).
  - ▶ First loosen and remove the negative terminal clamp on the auxiliary battery so that the clamp is no longer in contact with the terminal.
  - ▶ Remove positive terminal clamp cover.
  - ▶ Loosen and remove the positive terminal clamp.
- i** If the auxiliary battery is located under a co-driver's seat without a cushion which can be

folded up, contact a qualified specialist workshop to disconnect and remove the auxiliary battery.

## Towing or tow-starting

### Permissible towing methods

In the event of a breakdown, Mercedes-Benz recommends that you have the vehicle transported instead of towed.

**!** **NOTE** Damage to the vehicle due to towing away incorrectly

- ▶ Observe the instructions and notes on towing away.

**!** **NOTE** Damage due to pushing the vehicle

A vehicle with a front wheel drive and automatic transmission may be damaged if it is pushed or towed too far and too fast when the engine is switched off.



- ▶ Do not push the vehicle more than 15 m faster than at walking pace.

**i** **Vehicles with automatic transmission and rear wheel drive:** if there is a malfunction, the automatic transmission may be locked in position **P**.

If the automatic transmission cannot be shifted to position **N**, transport the vehicle (→ page 296). A towing vehicle with lifting equipment is required for vehicle transport.

**i** **Vehicles with automatic transmission and front wheel drive:** if there is a malfunction, the automatic transmission may be locked in position **P**. You can release the parking lock manually (→ page 126). If the automatic transmission cannot be shifted to position **N**, transport the vehicle (→ page 296). A towing vehicle with lifting equipment is required for vehicle transport.

## Permissible towing methods

	 Both axles on the ground	 Front axle raised	 Rear axle raised
Vehicles with manual transmission	Yes, no further than 100 km at 50 km/h	Yes, no further than 100 km at 50 km/h	Yes, no further than 50 km at 50 km/h
Vehicles with automatic transmission and rear wheel drive	Yes, no further than 50 km at 50 km/h	Yes, no further than 50 km at 50 km/h	Yes, if the steering wheel is fixed in the centre position with a steering wheel lock
Vehicles with automatic transmission and front wheel drive	No (when the engine is switched off) Yes (when the engine is running), maximum 5 km at 20 km/h	Yes	No (when the engine is switched off) Yes (when the engine is running), maximum 5 km at 20 km/h
Vehicles with all-wheel drive	Yes, no further than 50 km at 50 km/h	No	No

**Towing with a raised axle:** towing should be performed by a towing company.

### Towing away the vehicle with both axles on the ground

- ▶ Observe the notes on permissible towing methods (→ page 293).
- ▶ Make sure that the battery is connected and charged.

If the battery is discharged:

- the engine cannot be started.
- it is not possible to release or apply the electric parking brake.
- **Vehicles with automatic transmission:** automatic transmission cannot be shifted to position **N** or **P**.

**!** **NOTE** Damage due to pushing the vehicle

A vehicle with a front wheel drive and automatic transmission may be damaged if it is pushed or towed too far and too fast when the engine is switched off.

- ▶ Do not push the vehicle more than 15 m faster than at walking pace.

**!** **NOTE** Damage due to towing away at excessively high speeds or over long distances

The drivetrain could be damaged when towing at excessively high speeds or over long distances.

- ▶ A towing speed of 50 km/h must not be exceeded.
- ▶ A towing distance of 50 km must not be exceeded.

- i** **Vehicles with automatic transmission and rear wheel drive:** if there is a malfunction, the automatic transmission may be locked in position **P**. If the automatic transmission cannot be shifted to position **N**, transport the vehicle (→ page 296). A towing vehicle with lifting equipment is required for vehicle transport.
- i** **Vehicles with automatic transmission and front wheel drive:** if there is a malfunction, the automatic transmission may be locked in position **P**. You can release the parking lock manually (→ page 126).



If the automatic transmission cannot be shifted to position **[N]**, transport the vehicle (→ page 296). A towing vehicle with lifting equipment is required for vehicle transport.

**⚠ WARNING** Risk of accident when towing a vehicle which is too heavy

If the vehicle being tow-started or towed away is heavier than the permissible gross mass, the following situations can occur:

- the towing eye may become detached.
  - the car/trailer combination may swerve or even overturn.
- ▶ If another vehicle is tow-started or towed away, its weight must not exceed the permissible gross mass of your own vehicle.

If a vehicle needs to be towed or tow started, its weight should not be greater than the permissible gross mass of the towing vehicle.

- ▶ Information on the vehicle's permissible gross mass can be found on the vehicle identification plate .
- ▶ **Vehicles with automatic transmission:** do not open the driver's or co-driver door, as the automatic transmission will automatically shift to position **[P]**.
- ▶ Fit the towing eye (→ page 297).
- ▶ Secure the towing device.

**! NOTE** Damage due to incorrect connection

- ▶ Only connect the tow rope or tow bar to the towing eyes.

**i** You can also secure the towing device to the trailer hitch.

**! NOTE** Damage and risk of accident when towing with a tow rope

There is a risk of an accident if you do not observe safety and protective measures when towing using a tow rope.

Observe the following points when towing with a tow rope:

- ▶ Secure the tow rope on the same side on both vehicles, if possible.

- ▶ Make sure the tow rope does not exceed the legally prescribed length.
- ▶ Mark the tow rope in the middle, e.g. with a white cloth (30 x 30 cm). This makes other road users aware that a vehicle is being towed.
- ▶ Observe the brake lamps of the towing vehicle while driving. Always maintain a distance that ensures the tow rope does not sag.
- ▶ do not use steel cables or chains to tow your vehicle. Otherwise, you could damage the vehicle.

- ▶ Deactivate automatic locking (→ page 45).
- ▶ Do not activate the HOLD function.
- ▶ Deactivate tow-away protection (→ page 58).
- ▶ Deactivate Active Brake Assist (→ page 150).
- ▶ **Vehicles with automatic transmission:** shift the automatic transmission to position **[N]**.
- ▶ **Vehicles with manual transmission:** shift to neutral **[N]**.
- ▶ Release the parking brake.
- ▶ **Vehicles with manual transmission:** switch on the ignition otherwise the steering wheel locking may engage.

**⚠ WARNING** Risk of accident due to limited safety-related functions during the towing process

Safety-related functions are limited or no longer available in the following situations:

- the ignition is switched off.
- the brake system or power steering system is malfunctioning.
- the energy supply or the on-board electrical system is malfunctioning.

When your vehicle is then towed away, significantly more effort may be required to steer and brake than is normally required.

- ▶ Use a tow bar.
- ▶ Make sure that the steering wheel can move freely, before towing the vehicle away.



**!** **NOTE** Damage due to excessive tractive power

If you pull away sharply, the tractive power may be too high and the vehicles could be damaged.

► Pull away slowly and smoothly.

### Towing a vehicle with the front or rear axle raised

**!** **NOTE** Damage when the ignition is switched on

If you leave the ignition switched on when towing the vehicle with the front or rear axle raised, ESP® actuation can damage the brake system.

► The ignition must be switched off.

**!** **NOTE** Damage due to incorrect removal or installation of the propeller shafts

When installing the propeller shafts, they can be damaged if you do not use new screws.

Always use new screws when installing the propeller shafts.

Only have the propeller shafts installed or removed by qualified, skilled personnel.

**i** If the front axle is damaged, raise the vehicle at the front axle and if the rear axle is damaged, raise the vehicle at the rear axle.

**i** **Vehicles with automatic transmission and rear wheel drive:** if there is a malfunction, the automatic transmission may be locked in position **P**.

If the automatic transmission cannot be shifted to position **N**, transport the vehicle (→ page 296). A towing vehicle with lifting equipment is required for vehicle transport.

**i** **Vehicles with automatic transmission and front wheel drive:** if there is a malfunction, the automatic transmission may be locked in position **P**. You can release the parking lock manually (→ page 126).

If the automatic transmission cannot be shifted to position **N**, transport the vehicle (→ page 296). A towing vehicle with lifting equipment is required for vehicle transport.

► Observe the notes on permissible towing methods (→ page 293).

► The propeller shafts to the drive axles must be removed if the maximum permissible towing distance is exceeded.

► **Vehicles with automatic transmission:** shift the automatic transmission to position **N**.

► **Vehicles with manual transmission:** shift to neutral **N**.

► Release the parking brake.

► Switch off the ignition.

### Loading the vehicle for transport

► Observe the notes on towing away (→ page 294) (→ page 296).

► Connect the tow bar to the towing eye to load the vehicle.

► **Vehicles with automatic transmission:** shift the automatic transmission to position **N**.

**i** **Vehicles with automatic transmission:** in the event of damage to the electrics, the automatic transmission may be locked in position **P**. To shift to **N** provide the on-board electrical system with power (→ page 286).

► **Vehicles with manual transmission:** shift to neutral **N**.

► Load the vehicle onto the transporter.

► **Vehicles with automatic transmission:** shift the automatic transmission to position **P**.

► **Vehicles with manual transmission:** engage first **1** or reverse gear **R**.

► Use the parking brake to secure the vehicle against rolling away.

► Only secure the vehicle by the wheels.

### Vehicles with all-wheel drive/vehicles with automatic transmission

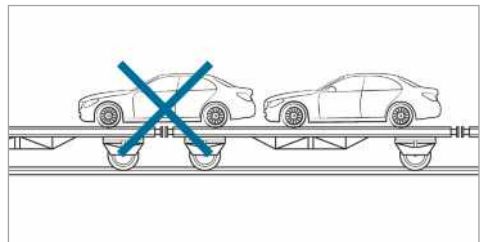

- ▶ Make sure that the front and rear axles come to rest on the same transportation vehicle.

**!** **NOTE** Damage to the drivetrain due to incorrect positioning

- ▶ Do not position the vehicle above the connection point of the transport vehicle.

**!** **NOTE** Vehicle damage due to improper loading

An all-wheel drive vehicle can be damaged if it is tilted, pushed or moved during loading using a hydraulic platform.

- ▶ When loading a vehicle with all-wheel drive, the vehicle should only be moved and positioned by its own power.
- ▶ The vehicle and the surface it is positioned on should no longer be moved when the key is removed or if the door is open.

### Towing eye storage location

The towing eye is located in the vehicle tool kit in the front passenger footwell (→ page 299).

### Towing eye

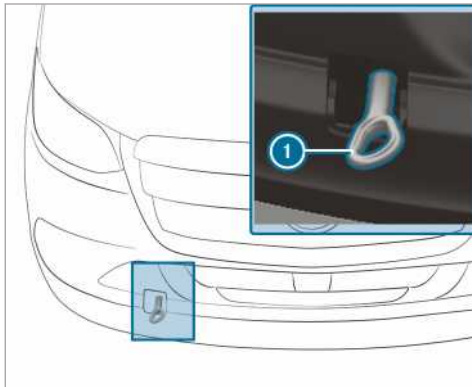

Fitting and removing the front towing eye

- ▶ **To fit the front towing eye:** press the top of the cover and remove the cover.
- ▶ Screw in the towing eye ① clockwise to the stop and tighten.

- ▶ **To remove the front towing eye:** unscrew towing eye ① anti-clockwise.

- ▶ Insert the cover with the tabs at the top and push in at the bottom until the cover engages.

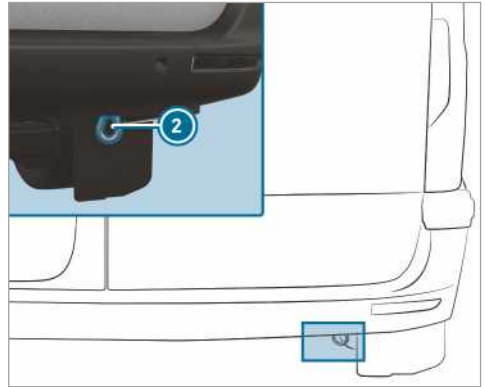

Rear towing eye (vehicles with passenger vehicle approval)

- ① Rear towing eye ② is permanently attached to the vehicle.

**!** **NOTE** Damage due to incorrect use of the towing eye

When a towing eye is used to recover a vehicle, the vehicle may be damaged in the process.

- ▶ Only use the towing eye to tow away or tow start the vehicle.

### Tow starting vehicle (emergency engine start)

#### Vehicles with automatic transmission

**!** **NOTE** Damage to the automatic transmission due to tow-starting

The automatic transmission may be damaged in the process of tow-starting vehicles with automatic transmission.

- ▶ Vehicles with automatic transmission must not be tow-started.

- ▶ Do not tow start vehicles with automatic transmission.

#### Vehicles with manual transmission

- ▶ Observe the notes on towing away (→ page 293).

- ▶ If necessary, allow the engine and the exhaust system to cool down.
- ▶ Switch on the ignition.
- ▶ Engage 2nd or 3rd gear.
- ▶ Release the parking brake.
- ▶ Keep the clutch pedal fully depressed when tow starting the vehicle.
- ▶ Release the clutch pedal slowly.
- ▶ When the engine has started, engage neutral immediately.
- ▶ Stop in a safe location.
- ▶ Remove the towing device.
- ▶ Remove the towing eye.
- ▶ Have the vehicle checked at a qualified specialist workshop.

## Electrical fuses

### Notes on electrical fuses

**⚠ WARNING** Risk of accident and injury due to overloaded lines

If you manipulate or bridge a faulty fuse or if you replace it with a fuse with a higher amperage, the electric line could be overloaded.

This could result in a fire.

- ▶ Always replace faulty fuses with specified new fuses containing the correct amperage.

**! NOTE** Damage caused by incorrect fuses

Incorrect fuses may cause damage to electrical components or systems.

- ▶ Only use Mercedes-Benz approved fuses with the correct fuse rating.

The electrical fuses in your vehicle switch off defective circuits. If a fuse blows, all the components on the circuit and their functions will cease to operate.

Blown fuses must be replaced with fuses of an equivalent specification, which you can determine by the colour and fuse rating. The fuse allocation chart and further information on the electric fuses and relays can be found in the "Fuse allocation chart" supplement.

**! NOTE** Damage or malfunctions caused by moisture

Moisture may cause damage to the electrical system or cause it to malfunction.

- ▶ When the fuse box is open, make sure that no moisture can enter the fuse box.
- ▶ When closing the fuse box, make sure that the seal of the lid is positioned correctly on the fuse box.

If the new fuse which has been inserted also blows, have the cause traced and rectified at a qualified specialist workshop.

Make sure of the following before replacing a fuse:

- the vehicle is secured such that it does not roll away
- all electrical consumers are switched off
- the ignition is switched off

The fuses are located in various fuse boxes:

- fuse box in the co-driver footwell (→ page 299)
- fuse box in the seat base of the driver's seat (→ page 298)

### Opening the fuse box in the seat base of the driver's seat

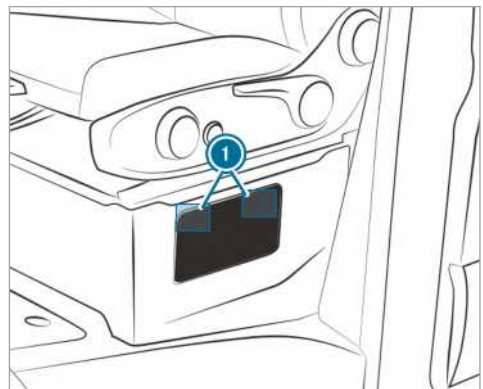

- ▶ **To open:** press down and unclip fasteners ① on the cover.
- ▶ Remove the cover.

## Opening the fuse box in the co-driver footwell

- ▶ Unlocking and removing the stowage compartment cover in the co-driver footwell (→ page 299).

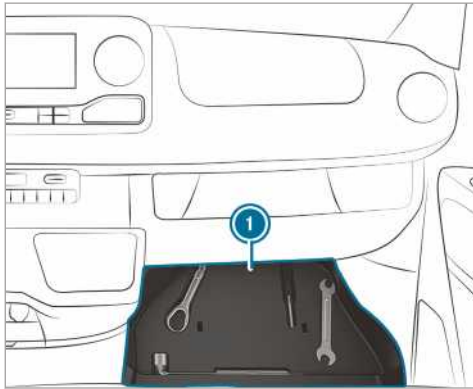

- ▶ Remove insert ① with the vehicle tool kit.

## Vehicle tool kit

### Information on the vehicle tool kit

The vehicle tool kit is located in the stowage compartment in the footwell on the co-driver side (→ page 299).

The vehicle tool kit contains:

- a towing eye
- a screwdriver with Torx, Phillips and slotted bits
- the vehicle tool kit can also contain the following, for example:
  - an open-end spanner
  - a wheel spanner

## Unlocking and removing the stowage compartment cover

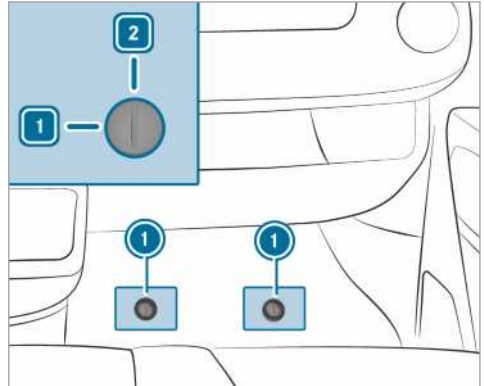

- ▶ Remove the rubber mat from the co-driver's footwell.
- ▶ **To unlock:** turn the quick-release fastener ① anti-clockwise to position 1.
- ▶ Slightly raise and pull out the cover.

## Inserting and locking the cover

- ▶ Slide in the cover and press it downwards.
- ▶ Press down the quick-release fastener ① until it engages.
- ▶ **To lock:** turn the quick-release fastener ① clockwise to position 2.

## Removing the vehicle tool kit

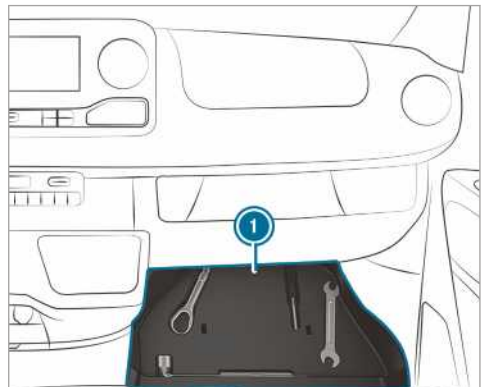

- ▶ Remove the vehicle tool kit from the stowage compartment ①.

## Hydraulic jack

### Information on the hydraulic jack

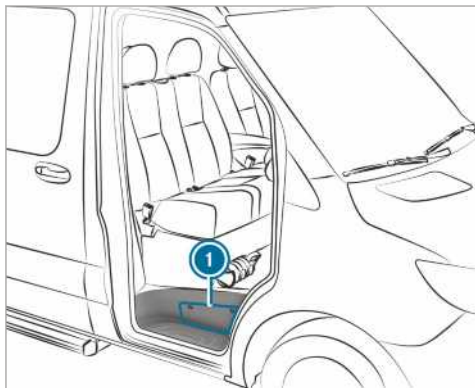

The hydraulic jack is located in side compartment ① above the co-driver's door step.

The jack has a maximum weight of 7.5 kg depending on the vehicle's equipment. You will find the maximum load capacity of the jack stated on the adhesive label attached to the jack. If there is a malfunction, please contact a qualified specialist workshop.

Jack maintenance:

- Clean and grease all moving parts after use.
- Extend and retract the pistons fully every six months.

### Removing the pump lever rod and the jack

#### Requirements:

- The co-driver door is open.

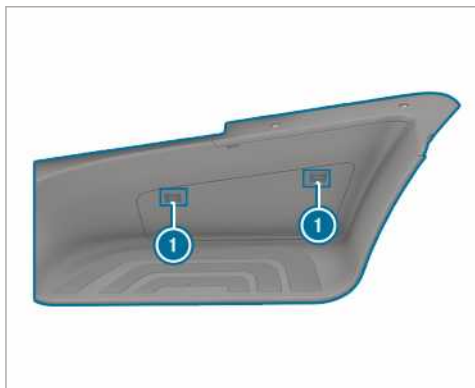

- ▶ **To open:** press down and unclip fasteners ① on the cover.
- ▶ Remove the cover.
- ▶ Pull out the holder completely and place it on the step.



- ▶ Remove jack ② and the pump lever rod.
- ▶ **To close:** press the cover firmly so that fasteners ① engage.

### Noise or unusual driving characteristics

While driving, pay attention to vibrations, noises and unusual driving characteristics, e.g. pulling to one side. This may indicate damage to the wheels or tyres. If you suspect that a tyre is defective, reduce your speed. Stop the vehicle as soon as possible to check the wheels and tyres for damage. Hidden tyre damage could also be causing the unusual driving characteristics. If no signs of damage can be detected, have the tyres and wheels checked at a qualified specialist workshop.

### Regular checking of wheels and tyres

**⚠ WARNING** Risk of accident from damaged tyres

Damaged tyres can cause tyre pressure loss. As a result, you could lose control of your vehicle.

- ▶ Check the tyres regularly for signs of damage and replace any damaged tyres immediately.

**⚠ WARNING** Risk of aquaplaning due to insufficient tyre tread

Insufficient tyre tread will result in reduced tyre grip. The tyre tread is no longer able to dissipate water.

This means that in heavy rain or slush the risk of aquaplaning is increased, in particular where speed is not adapted to suit the conditions.

If the tyre pressure is too high or too low, tyres may exhibit different levels of wear at different locations on the tyre tread.

- ▶ Thus, you should regularly check the tread depth and the condition of the tread across the entire width of all tyres.

Minimum tread depth for:

- Summer tyres: 3 mm
- M+S tyres: 4 mm
- ▶ For safety reasons, replace the tyres before the legally prescribed limit for the minimum tread depth is reached.

Check the wheels and tyres of your vehicle for damage regularly, i.e. at least every two weeks,

as well as after driving off-road or on rough roads. Damaged wheels can lead to a loss of tyre pressure.

Pay attention to damage such as:

- cuts in the tyres
- punctures in the tyres
- tears in the tyres
- bulges on tyres
- deformation or severe corrosion on wheels

Conduct the following checks regularly, at least once a month or as required, e.g. before a long journey or when driving off-road, on all wheels:

- check the tyre pressure (→ page 303).
- check the valve caps

Valves must be protected from moisture and dirt with valve caps specifically approved by Mercedes-Benz for your vehicle.

- visually inspect the tread depth and the tyre tread across the whole tyre width

For summer tyres, the minimum tread depth is 3 mm and for winter tyres 4 mm.

### Information on driving with summer tyres

At temperatures below 10 °C summer tyres lose elasticity and therefore traction and braking power. Change the tyres on your vehicle to M+S tyres. Using summer tyres at very cold temperatures could cause tears to form, thereby damaging the tyres permanently. We cannot accept responsibility for this type of damage.

Always observe the maximum permitted speed specified for the summer tyres you have fitted .

Once you have fitted the summer tyres:

- Check the tyre pressure (→ page 303)
- Restart tyre pressure monitor (→ page 315)

### Information on M+S tyres

Use winter tyres or all-season tyres at temperatures below 10 °C. Both types of tyre are identified by the M+S marking.

Only winter tyres bearing the  snowflake symbol in addition to the M+S marking provide the best possible grip in wintry road conditions.

Only these tyres will allow driving safety systems such as ABS and ESP® to function optimally in winter. These tyres have been developed specifically for driving in snow.

Use M+S tyres of the same make and tread on all wheels to maintain safe handling characteristics.

Always observe the maximum permissible speed specified for the M+S tyres you have fitted .

If you fit M+S tyres that have a lower maximum permissible speed than the maximum design speed of the vehicle, affix an appropriate warning sign in the driver's field of vision. You can obtain this at a qualified specialist workshop.

For vehicles with a limiter: in this case, you should also restrict the maximum design speed of the vehicle using the permanent limiter so that it does not exceed the maximum permissible speed for the M+S tyres (→ page 152).

Once you have fitted the winter tyres:

- Check the tyre pressure (→ page 303)
- Restart the tyre pressure monitor (→ page 315)

### Notes on snow chains

**⚠ WARNING** Risk of accident due to incorrect fitting of snow chains

**Vehicles with rear-wheel drive:** if you have fitted snow chains to the front wheels, they may drag against the vehicle body or chassis components.

This could cause damage to the vehicle or the tyres.

- ▶ Never fit snow chains on the front wheels.
- ▶ Only fit snow chains on the rear wheels in pairs.
- ▶ **Vehicles with twin tyres:** fit the snow chains to the outer wheels.

**⚠ WARNING** Risk of accident due to incorrect fitting of snow chains

**Vehicles with front-wheel drive:** if you have fitted snow chains to the rear wheels, they may drag against the vehicle body or chassis components.

This could cause damage to the vehicle or the tyres.

- ▶ Never fit snow chains on the rear wheels.
- ▶ Only fit snow chains on the front wheels in pairs.

**⚠ WARNING** Risk of accident due to unsuitable snow chains

Vehicles with all-wheel drive, or front-wheel drive and single tyres, do not have sufficient clearance on the front axle for commercially available snow chains.

When you fit commercially available snow chains, the snow chains may come loose and damage chassis components or brake hoses.

- ▶ Only fit snow chains on vehicles with all-wheel drive, or front-wheel drive and single tyres, which have been approved for these tyres by Mercedes-Benz.

For safety reasons, Mercedes-Benz recommends that you only use snow chains that have been checked and approved. You can find further information on snow chains recommended by Mercedes-Benz in the wheel and tyre overview at <https://www.mercedes-benz.de>.

**ⓘ NOTE** Damage to the wheel trim from fitted snow chains

If snow chains are fitted to steel wheels, the wheel trims can be damaged.

- ▶ Remove the wheel trims of steel wheels before fitting snow chains.

Observe the following notes when using snow chains:

- Snow chains are only permissible for certain wheel/tyre combinations. You can obtain information on them at a qualified specialist workshop.
- For safety reasons, only use snow chains that have been specifically approved for your vehicle by Mercedes-Benz, or snow chains with the same quality standard.
- The snow chains must be retightened after driving approximately 1 km. This is the only way to ensure the snow chains are optimally seated with clearance to adjacent components.
- **Vehicles with all-wheel drive:** fit snow chains to all wheels. On vehicles with twin tyres, fit the snow chains to the outer wheels. Observe the manufacturer's installation instructions.
- Use snow chains only when the road surface is completely snow-covered. Remove the

snow chains as soon as possible when you come to a road that is not snow-covered.

- Local regulations may restrict the use of snow chains. Observe the applicable regulations before fitting snow chains.
  - Activate all-wheel drive before driving off with snow chains (→ page 128).
  - If snow chains are fitted, the maximum permissible speed is 50 km/h.
  - **Vehicles with Parking Assist:** do not use Parking Assist PARKTRONIC if snow chains are fitted.
- ⓘ You can permanently limit the maximum vehicle speed for driving with winter tyres (→ page 152).
- ⓘ You can deactivate ESP® to pull away (→ page 147). This allows the wheels to spin, achieving an increased driving force.

## Tyre pressure

### Notes on tyre pressure

#### **⚠ WARNING** Risk of accident due to insufficient or excessive tyre pressure

Underinflated or overinflated tyres pose the following risks:

- The tyres may burst, especially as the load and vehicle speed increase.
  - The tyres may wear excessively and/or unevenly, which may greatly impair tyre traction.
  - The driving characteristics, as well as steering and braking, may be greatly impaired.
- ▶ Comply with the recommended tyre pressure and check the tyre pressure of all tyres including the spare wheel regularly:
- at least once a month
  - when the load changes
  - before embarking on a longer journey
  - if operating conditions change, e.g. off-road driving
- ▶ Adjust the tyre pressure as necessary.

Driving with tyre pressure that is too high or too low can:

- Shorten the service life of the tyres.
- Cause increased tyre damage.
- Adversely affect handling characteristics and thus driving safety, e.g. due to aquaplaning.

#### **⚠ WARNING** Risk of accident from repeated tyre pressure drop

If the tyre pressure drops repeatedly, the wheel, valve or tyre may be damaged.

Insufficient tyre pressure can cause the tyres to burst.

- ▶ Inspect the tyre for signs of foreign objects.
- ▶ Check whether the wheel or valve has a leak.
- ▶ If you are unable to rectify the damage, contact a qualified specialist workshop.

Information on the recommended tyre pressure for the vehicle's factory-fitted tyres can be found on the tyre pressure table on the driver's seat base or on the B-pillar on the driver's side .

Use a suitable pressure gauge to check the tyre pressure. The outer appearance of a tyre does not permit any reliable conclusion about the tyre pressure.

**Vehicles with a tyre pressure monitor:** you can also check the tyre pressure using the on-board computer.

Only correct tyre pressures when the tyres are cold. Conditions for cold tyres:

- The vehicle has been parked with the tyres out of direct sunlight for at least three hours.
- The vehicle has travelled less than 1.6 km.

A rise in the tyre temperature of 10 °C increases the tyre pressure by approx. 10 kPa (0.1 bar / 1.5 psi). Take this into account when checking the tyre pressure of warm tyres.

#### **Notes on towing a trailer**

The applicable tyre pressure for the tyres of the rear axle is always the recommended tyre pressure for a full load.

### Tyre pressure table

The tyre pressure table can be found on the seat base or on the B-pillar on the driver's side.



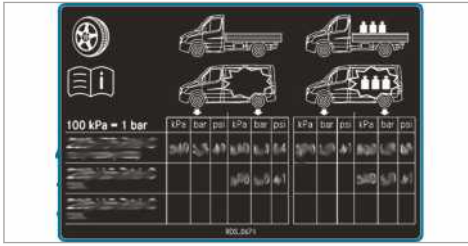

The tyre pressure table shows the recommended tyre pressure for the tyres fitted at the factory on

this vehicle. The recommended tyre pressures are valid for cold tyres and different vehicle load conditions.

If one or more tyre sizes precede a tyre pressure, the tyre pressure information following is only valid for those tyre sizes.

If the preceding tyre sizes are supplemented by the  symbol, the tyre pressure information following shows alternative tyre pressures.

The load conditions "empty" and "fully laden" are defined in the table for varying weights.

**Front axle tyre pressures on vehicles with front-wheel drive**  
**Max. front axle load 1750 kg**

Tyres/disc wheel	Vehicle load	Max. front axle load 1750 kg
225/65R16C 112/110R	Fully laden	360 kPa (3.6 bar/52 psi)
225/65R16C 112/110R	Empty	330 kPa (3.3 bar/48 psi)
225/75R16C 118/116R	Fully laden	320 kPa (3.2 bar/46 psi)
225/75R16C 118/116R	Empty	300 kPa (3.0 bar/44 psi)
225/75R16C 121/120R	Fully laden	320 kPa (3.2 bar/46 psi)
225/75R16C 121/120R	Empty	300 kPa (3.0 bar/44 psi)
235/60R17C 117/115R	Fully laden	340 kPa (3.4 bar/49 psi)
235/60R17C 117/115R	Empty	310 kPa (3.1 bar/45 psi)

**Max. front axle load 1850 kg**

Tyres/disc wheel	Vehicle load	Max. front axle load 1850 kg
225/65R16C 112/110R	Fully laden	390 kPa (3.9 bar/57 psi)
225/65R16C 112/110R	Empty	330 kPa (3.3 bar/48 psi)
225/75R16C 118/116R	Fully laden	350 kPa (3.5 bar/51 psi)
225/75R16C 118/116R	Empty	300 kPa (3.0 bar/44 psi)
225/75R16C 121/120R	Fully laden	350 kPa (3.5 bar/51 psi)
225/75R16C 121/120R	Empty	300 kPa (3.0 bar/44 psi)
235/60R17C 117/115R	Fully laden	360 kPa (3.6 bar/52 psi)
235/60R17C 117/115R	Empty	310 kPa (3.1 bar/45 psi)

**Max. front axle load 2000 kg**

Tyres/disc wheel	Vehicle load	Max. front axle load 2000 kg
225/65R16C 112/110R	Fully laden	-
225/65R16C 112/110R	Empty	-
225/75R16C 118/116R	Fully laden	380 kPa (3.8 bar/55 psi)
225/75R16C 118/116R	Empty	300 kPa (3.0 bar/44 psi)
225/75R16C 121/120R	Fully laden	380 kPa (3.8 bar/55 psi)
225/75R16C 121/120R	Empty	300 kPa (3.0 bar/44 psi)
235/60R17C 117/115R	Fully laden	400 kPa (4.0 bar/58 psi)
235/60R17C 117/115R	Empty	310 kPa (3.1 bar/45 psi)

**Max. front axle load 2100 kg**

Tyres/disc wheel	Vehicle load	Max. front axle load 2100 kg
225/65R16C 112/110R	Fully laden	-
225/65R16C 112/110R	Empty	-
225/75R16C 118/116R	Fully laden	410 kPa (4.1 bar/60 psi)
225/75R16C 118/116R	Empty	300 kPa (3.0 bar/44 psi)
225/75R16C 121/120R	Fully laden	410 kPa (4.1 bar/60 psi)
225/75R16C 121/120R	Empty	300 kPa (3.0 bar/44 psi)
235/60R17C 117/115R	Fully laden	420 kPa (4.2 bar/61 psi)
235/60R17C 117/115R	Empty	310 kPa (3.1 bar/45 psi)

**Rear axle tyre pressures on vehicles with front-wheel drive****Max. rear axle load 2100 kg**

Tyres/disc wheel	Vehicle load	Max. rear axle load 2100 kg
225/65R16C 112/110R	Fully laden	450 kPa (4.5 bar/65 psi)
225/65R16C 112/110R	Empty	330 kPa (3.3 bar/48 psi)
225/75R16C 118/116R	Fully laden	410 kPa (4.1 bar/60 psi)
225/75R16C 118/116R	Empty	300 kPa (3.0 bar/44 psi)
225/75R16C 121/120R	Fully laden	410 kPa (4.1 bar/60 psi)
225/75R16C 121/120R	Empty	300 kPa (3.0 bar/44 psi)

Tyres/disc wheel	Vehicle load	Max. rear axle load 2100 kg
235/60R17C 117/115R	Fully laden	420 kPa (4.2 bar/61 psi)
235/60R17C 117/115R	Empty	310 kPa (3.1 bar/45 psi)

**Max. rear axle load 2430 kg**

Tyres/disc wheel	Vehicle load	Max. rear axle load 2430 kg
225/65R16C 112/110R	Fully laden	-
225/65R16C 112/110R	Empty	-
225/75R16C 118/116R	Fully laden	490 kPa (4.9 bar/71 psi)
225/75R16C 118/116R	Empty	300 kPa (3.0 bar/44 psi)
225/75R16C 121/120R	Fully laden	490 kPa (4.9 bar/71 psi)
225/75R16C 121/120R	Empty	300 kPa (3.0 bar/44 psi)
235/60R17C 117/115R	Fully laden	500 kPa (5.0 bar/73 psi)
235/60R17C 117/115R	Empty	310 kPa (3.1 bar/45 psi)

**Front axle tyre pressures on motor caravan vehicles with front-wheel drive****Motor caravan, max. front axle load 1750 kg**

Tyres/disc wheel	Vehicle load	Max. front axle load 1750 kg
225/75R16CP 118R	Fully laden	320 kPa (3.2 bar/46 psi)
235/60R17C 117/115R	Fully laden	330 kPa (3.3 bar/48 psi)

**Motor caravan, max. front axle load 1850 kg**

Tyres/disc wheel	Vehicle load	Max. front axle load 1850 kg
225/75R16CP 118R	Fully laden	350 kPa (3.5 bar/51 psi)
235/60R17C 117/115R	Fully laden	360 kPa (3.6 bar/52 psi)

**Motor caravan, max. front axle load 2000 kg**

Tyres/disc wheel	Vehicle load	Max. front axle load 2000 kg
225/75R16CP 118R	Fully laden	380 kPa (3.8 bar/55 psi)
235/60R17C 117/115R	Fully laden	400 kPa (4.0 bar/58 psi)

**Motor caravan, max. front axle load 2100 kg**

Tyres/disc wheel	Vehicle load	Max. front axle load 2100 kg
225/75R16CP 118R	Fully laden	410 kPa (4.1 bar/60 psi)
235/60R17C 117/115R	Fully laden	420 kPa (4.2 bar/61 psi)

- i** Due to the high unladen weight of the motor caravan vehicles, empty tyre pressures are not intended and not permitted.

**Rear axle tyre pressures on motor caravan vehicles with front-wheel drive****Max. rear axle load 2100 kg**

Tyres/disc wheel	Vehicle load	Max. rear axle load 2430 kg
225/75R16CP 118R	Fully laden	550 kPa (5.5 bar/80 psi)
235/60R17C 117/115R	Fully laden	530 kPa (5.3 bar/78 psi)

**Max. rear axle load 2430 kg**

Tyres/disc wheel	Vehicle load	Max. rear axle load 2430 kg
225/75R16CP 118R	Fully laden	550 kPa (5.5 bar/80 psi)
235/60R17C 117/115R	Fully laden	530 kPa (5.3 bar/78 psi)

- i** Due to the high unladen weight of the motor caravan vehicles, empty tyre pressures are not intended and not permitted.

**Front axle tyre pressures on vehicles with rear-wheel drive and Single tyres****Max. front axle load 1650 kg**

Tyres/disc wheel	Vehicle load	Max. front axle load 1650 kg
205/75R16C 110/108R	Fully laden	360 kPa (3.6 bar/52 psi)
205/75R16C 110/108R	Empty	330 kPa (3.3 bar/48 psi)
225/75R16C 121/120R	Fully laden	300 kPa (3.0 bar/44 psi)
225/75R16C 121/120R	Empty	300 kPa (3.0 bar/44 psi)
225/75R16C 118/116R	Fully laden	300 kPa (3.0 bar/44 psi)
225/75R16C 118/116R	Empty	300 kPa (3.0 bar/44 psi)
235/65R16C 115/113R	Fully laden	300 kPa (3.0 bar/44 psi)
235/65R16C 115/113R	Empty	300 kPa (3.0 bar/44 psi)

Tyres/disc wheel	Vehicle load	Max. front axle load 1650 kg
235/65R16C 121/119R	Fully laden	300 kPa (3.0 bar/44 psi)
235/65R16C 121/119R	Empty	300 kPa (3.0 bar/44 psi)
235/65R16C 118/116R	Fully laden	300 kPa (3.0 bar/44 psi)
235/65R16C 118/116R	Empty	300 kPa (3.0 bar/44 psi)
235/60R17C 117/115R	Fully laden	320 kPa (3.2 bar/46 psi)
235/60R17C 117/115R	Empty	310 kPa (3.1 bar/45 psi)

**Max. front axle load 1860 kg**

Tyres/disc wheel	Vehicle load	Max. front axle load 1860 kg
205/75R16C 110/108R	Fully laden	-
205/75R16C 110/108R	Empty	-
225/75R16C 121/120R	Fully laden	350 kPa (3.5 bar/51 psi)
225/75R16C 121/120R	Empty	300 kPa (3.0 bar/44 psi)
225/75R16C 118/116R	Fully laden	350 kPa (3.5 bar/51 psi)
225/75R16C 118/116R	Empty	300 kPa (3.0 bar/44 psi)
235/65R16C 115/113R	Fully laden	350 kPa (3.5 bar/51 psi)
235/65R16C 115/113R	Empty	300 kPa (3.0 bar/44 psi)
235/65R16C 121/119R	Fully laden	350 kPa (3.5 bar/51 psi)
235/65R16C 121/119R	Empty	300 kPa (3.0 bar/44 psi)
235/65R16C 118/116R	Fully laden	350 kPa (3.5 bar/51 psi)
235/65R16C 118/116R	Empty	300 kPa (3.0 bar/44 psi)
235/60R17C 117/115R	Fully laden	380 kPa (3.8 bar/55 psi)
235/60R17C 117/115R	Empty	310 kPa (3.1 bar/45 psi)

**Max. front axle load 2000 kg**

Tyres/disc wheel	Vehicle load	Max. front axle load 2000 kg
205/75R16C 110/108R	Fully laden	-
205/75R16C 110/108R	Empty	-
225/75R16C 121/120R	Fully laden	370 kPa (3.7 bar/54 psi)
225/75R16C 121/120R	Empty	300 kPa (3.0 bar/44 psi)

<b>Tyres/disc wheel</b>	<b>Vehicle load</b>	<b>Max. front axle load 2000 kg</b>
225/75R16C 118/116R	Fully laden	370 kPa (3.7 bar/54 psi)
225/75R16C 118/116R	Empty	300 kPa (3.0 bar/44 psi)
235/65R16C 115/113R	Fully laden	-
235/65R16C 115/113R	Empty	-
235/65R16C 121/119R	Fully laden	380 kPa (3.8 bar/55 psi)
235/65R16C 121/119R	Empty	300 kPa (3.0 bar/44 psi)
235/65R16C 118/116R	Fully laden	380 kPa (3.8 bar/55 psi)
235/65R16C 118/116R	Empty	300 kPa (3.0 bar/44 psi)
235/60R17C 117/115R	Fully laden	400 kPa (4.0 bar/58 psi)
235/60R17C 117/115R	Empty	310 kPa (3.1 bar/45 psi)

#### **Rear axle tyre pressures on vehicles with rear-wheel drive and Single tyres**

**Max. rear axle load 1800 kg**

<b>Tyres/disc wheel</b>	<b>Vehicle load</b>	<b>Max. rear axle load 1800 kg</b>
205/75R16C 110/108R	Fully laden	400 kPa (4.0 bar/58 psi)
205/75R16C 110/108R	Empty	330 kPa (3.3 bar/48 psi)
225/75R16C 121/120R	Fully laden	330 kPa (3.3 bar/48 psi)
225/75R16C 121/120R	Empty	300 kPa (3.0 bar/44 psi)
225/75R16C 118/116R	Fully laden	330 kPa (3.3 bar/48 psi)
225/75R16C 118/116R	Empty	300 kPa (3.0 bar/44 psi)
235/65R16C 115/113R	Fully laden	340 kPa (3.4 bar/49 psi)
235/65R16C 115/113R	Empty	300 kPa (3.0 bar/44 psi)
235/65R16C 121/119R	Fully laden	340 kPa (3.4 bar/49 psi)
235/65R16C 121/119R	Empty	300 kPa (3.0 bar/44 psi)
235/65R16C 118/116R	Fully laden	340 kPa (3.4 bar/49 psi)
235/65R16C 118/116R	Empty	300 kPa (3.0 bar/44 psi)
235/60R17C 117/115R	Fully laden	350 kPa (3.5 bar/51 psi)
235/60R17C 117/115R	Empty	310 kPa (3.1 bar/45 psi)

**Max. rear axle load 2000 kg**

<b>Tyres/disc wheel</b>	<b>Vehicle load</b>	<b>Max. rear axle load 2000 kg</b>
205/75R16C 110/108R	Fully laden	-
205/75R16C 110/108R	Empty	-
225/75R16C 121/120R	Fully laden	380 kPa (3.8 bar/55 psi)
225/75R16C 121/120R	Empty	300 kPa (3.0 bar/44 psi)
225/75R16C 118/116R	Fully laden	380 kPa (3.8 bar/55 psi)
225/75R16C 118/116R	Empty	300 kPa (3.0 bar/44 psi)
235/65R16C 115/113R	Fully laden	380 kPa (3.8 bar/55 psi)
235/65R16C 115/113R	Empty	300 kPa (3.0 bar/44 psi)
235/65R16C 121/119R	Fully laden	380 kPa (3.8 bar/55 psi)
235/65R16C 121/119R	Empty	300 kPa (3.0 bar/44 psi)
235/65R16C 118/116R	Fully laden	380 kPa (3.8 bar/55 psi)
235/65R16C 118/116R	Empty	300 kPa (3.0 bar/44 psi)
235/60R17C 117/115R	Fully laden	400 kPa (4.0 bar/58 psi)
235/60R17C 117/115R	Empty	310 kPa (3.1 bar/45 psi)

**Max. rear axle load 2250 kg**

<b>Tyres/disc wheel</b>	<b>Vehicle load</b>	<b>Max. rear axle load 2250 kg</b>
205/75R16C 110/108R	Fully laden	-
205/75R16C 110/108R	Empty	-
225/75R16C 121/120R	Fully laden	430 kPa (4.3 bar/62 psi)
225/75R16C 121/120R	Empty	300 kPa (3.0 bar/44 psi)
225/75R16C 118/116R	Fully laden	430 kPa (4.3 bar/62 psi)
225/75R16C 118/116R	Empty	300 kPa (3.0 bar/44 psi)
235/65R16C 115/113R	Fully laden	450 kPa (4.5 bar/65 psi)
235/65R16C 115/113R	Empty	300 kPa (3.0 bar/44 psi)
235/65R16C 121/119R	Fully laden	450 kPa (4.5 bar/65 psi)
235/65R16C 121/119R	Empty	300 kPa (3.0 bar/44 psi)
235/65R16C 118/116R	Fully laden	450 kPa (4.5 bar/65 psi)
235/65R16C 118/116R	Empty	300 kPa (3.0 bar/44 psi)

Tyres/disc wheel	Vehicle load	Max. rear axle load 2250 kg
235/60R17C 117/115R	Fully laden	460 kPa (4.6 bar/67 psi)
235/60R17C 117/115R	Empty	310 kPa (3.1 bar/45 psi)

**Max. rear axle load 2430 kg**

Tyres/disc wheel	Vehicle load	Max. rear axle load 2430 kg <sup>1)</sup>
205/75R16C 110/108R	Fully laden	-
205/75R16C 110/108R	Empty	-
225/75R16C 121/120R	Fully laden	490 kPa (4.9 bar/71 psi)
225/75R16C 121/120R	Empty	300 kPa (3.0 bar/44 psi)
225/75R16C 118/116R	Fully laden	490 kPa (4.9 bar/71 psi)
225/75R16C 118/116R	Empty	300 kPa (3.0 bar/44 psi)
235/65R16C 115/113R	Fully laden	-
235/65R16C 115/113R	Empty	-
235/65R16C 121/119R	Fully laden	490 kPa (4.9 bar/71 psi)
235/65R16C 121/119R	Empty	300 kPa (3.0 bar/44 psi)
235/65R16C 118/116R	Fully laden	490 kPa (4.9 bar/71 psi)
235/65R16C 118/116R	Empty	300 kPa (3.0 bar/44 psi)
235/60R17C 117/115R	Fully laden	500 kPa (5.0 bar/73 psi)
235/60R17C 117/115R	Empty	310 kPa (3.1 bar/45 psi)

<sup>1)</sup> Only valid for vehicles with a permissible gross weight of over 3.2 t.

**Front axle tyre pressures on vehicles with rear-wheel drive and Single tyres****Max. front axle load 1850 kg**

Tyres/disc wheel	Vehicle load	Max. front axle load 1850 kg
195/75R16C 107/105R	Fully laden	440 kPa (4.4 bar/64 psi)
195/75R16C 107/105R	Empty	400 kPa (4.0 bar/58 psi)
205/75R16C 110/108R	Fully laden	410 kPa (4.1 bar/60 psi)
205/75R16C 110/108R	Empty	360 kPa (3.6 bar/52 psi)



Tyres/disc wheel	Vehicle load	Max. front axle load 1850 kg
205/75R16C 113/111R	Fully laden	-
205/75R16C 113/111R	Empty	-

**Max. front axle load 2000 kg**

Tyres/disc wheel	Vehicle load	Max. front axle load 2000 kg
195/75R16C 107/105R	Fully laden	-
195/75R16C 107/105R	Empty	-
205/75R16C 110/108R	Fully laden	440 kPa (4.4 bar/64 psi)
205/75R16C 110/108R	Empty	360 kPa (3.6 bar/52 psi)
205/75R16C 113/111R	Fully laden	-
205/75R16C 113/111R	Empty	-

**Max. front axle load 2100 kg**

Tyres/disc wheel	Vehicle load	Max. front axle load 2100 kg
195/75R16C 107/105R	Fully laden	-
195/75R16C 107/105R	Empty	-
205/75R16C 110/108R	Fully laden	-
205/75R16C 110/108R	Empty	-
205/75R16C 113/111R	Fully laden	480 kPa (4.8 bar/70 psi)
205/75R16C 113/111R	Empty	380 kPa (3.8 bar/55 psi)

**Rear axle tyre pressures on vehicles with rear-wheel drive and twin tyres****Max. rear axle load 3200 kg**

Tyres/disc wheel	Vehicle load	Max. rear axle load up to 3200 kg
195/75R16C 107/105R	Fully laden	410 kPa (4.1 bar/60 psi)
195/75R16C 107/105R	Empty	350 kPa (3.5 bar/51 psi)
205/75R16C 110/108R	Fully laden	370 kPa (3.7 bar/54 psi)
205/75R16C 110/108R	Empty	320 kPa (3.2 bar/46 psi)

Tyres/disc wheel	Vehicle load	Max. rear axle load up to 3200 kg
205/75R16C 113/111R	Fully laden	-
205/75R16C 113/111R	Empty	-

**Max. rear axle load 3500 kg**

Tyres/disc wheel	Vehicle load	Max. rear axle load 3500 kg
195/75R16C 107/105R	Fully laden	440 kPa (4.4 bar/64 psi)
195/75R16C 107/105R	Empty	350 kPa (3.5 bar/51 psi)
205/75R16C 110/108R	Fully laden	410 kPa (4.1 bar/60 psi)
205/75R16C 110/108R	Empty	320 kPa (3.2 bar/46 psi)
205/75R16C 113/111R	Fully laden	-
205/75R16C 113/111R	Empty	-

**Max. rear axle load 3600 kg**

Tyres/disc wheel	Vehicle load	Max. rear axle load 3600 kg
195/75R16C 107/105R	Fully laden	-
195/75R16C 107/105R	Empty	-
205/75R16C 110/108R	Fully laden	-
205/75R16C 110/108R	Empty	-
205/75R16C 113/111R	Fully laden	430 kPa (4.3 bar/62 psi)
205/75R16C 113/111R	Empty	340 kPa (3.4 bar/49 psi)

**Front axle tyre pressures on vehicles with rear-wheel drive and Super Single tyres****Max. front axle load 1850 kg**

Tyres/disc wheel	Vehicle load	Max. front axle load 1850 kg
225/75R16C 121/120R	Fully laden	340 kPa (3.4 bar/49 psi)
225/75R16C 121/120R	Empty	300 kPa (3.0 bar/44 psi)

**Max. front axle load 2000 kg**

Tyres/disc wheel	Vehicle load	Max. front axle load 2000 kg
225/75R16C 121/120R	Fully laden	370 kPa (3.7 bar/54 psi)
225/75R16C 121/120R	Empty	300 kPa (3.0 bar/44 psi)

**Rear axle tyre pressures on vehicles with rear-wheel drive and Super Single tyres****Max. rear axle load 3200 kg**

Tyres/disc wheel	Vehicle load	Max. rear axle load up to 3200 kg
225/75R16C 121/120R	Fully laden	690 kPa (6.9 bar/100 psi)
225/75R16C 121/120R	Empty	-
285/65R16C 131/129R	Fully laden	460 kPa (4.6 bar/67 psi)
285/65R16C 131/129R	Empty	400 kPa (4.0 bar/58 psi)

**Max. rear axle load 3500 kg**

Tyres/disc wheel	Vehicle load	Max. rear axle load 3500 kg
225/75R16C 121/120R	Fully laden	690 kPa (6.9 bar/100 psi) <sup>2)</sup>
225/75R16C 121/120R	Empty	-
285/65R16C 131/129R	Fully laden	520 kPa (5.2 bar/75 psi)
285/65R16C 131/129R	Empty	400 kPa (4.0 bar/58 psi)

<sup>2)</sup> Valid to use for a short time as a spare wheel on the rear axle for a maximum distance of 100 km and a maximum speed of 55 km/h.

Be sure to also observe the following further related subjects:

- Notes on tyre pressure (→ page 303)

**Tyre pressure monitor****Function of tyre pressure monitor on Single tyres**

The system checks the tyre pressure and the tyre temperature of the tyres fitted to the vehicle by means of a tyre pressure sensor.

New tyre pressure sensors, e.g. in winter tyres, are automatically taught-in the first time they are driven.

The tyre pressure and the tyre temperature appear in the multifunction display (→ page 176).

If there is a substantial loss of tyre pressure, a warning is issued:

- via display messages (→ page 361)
- via the  warning lamp in the instrument cluster

It is the driver's responsibility to set the tyre pressure to the recommended cold tyre pressure suitable for the operating situation. Set the tyre pressure for cold tyres using a tyre pressure gauge. Note that the correct tyre pressure for the current operating situation must first be taught-in to the tyre pressure monitoring system.

In most cases, the tyre pressure monitoring system will automatically update the new reference values after you have changed the tyre pressure.

You can, however, also update the reference values by restarting the tyre pressure monitoring system manually (→ page 315).

### System limitations

The system may be impaired or may not function in the following situations:

- if the tyre pressure is set incorrectly
- if there is a sudden pressure loss caused by a foreign object penetrating the tyre, for example
- if there is a malfunction caused by another radio signal source

Make sure to observe the following further related subject:

- Notes on tyre pressure (→ page 303)

### Checking the tyre pressure with the tyre pressure monitoring system

#### Requirements:

- The ignition is switched on.

On-board computer:

↪ Service ➤ Tyres

One of the following displays appears:

- the current tyre pressure and tyre temperature of the individual wheels

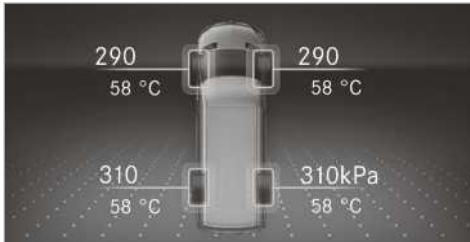

Instrument display with colour display

- the current tyre pressure for each wheel

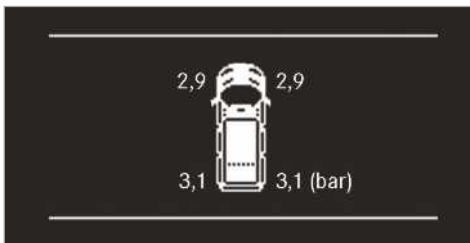

Instrument display with black and white display

- **Tyre pressures will be displayed after a few minutes of driving:** the teach-in process of the system is not yet complete. The tyre pressures are already being monitored.

▶ Compare the tyre pressure with the recommended tyre pressure for the current operating condition. Observe the notes on tyre temperature (→ page 303).

ⓘ The values displayed in the multifunction display may deviate from those of the tyre pressure gauge as they refer to sea level. At high altitudes, the tyre pressure values indicated by a pressure gauge are higher than those shown by the on-board computer. In this case, do not reduce the tyre pressures.

Make sure to observe the following further related subject:

- Notes on tyre pressure (→ page 303)

### Restarting the tyre pressure monitor

#### Requirements:

- The recommended tyre pressure is correctly set for the respective operating condition on each of the four wheels (→ page 303).

Restart the tyre pressure monitoring system in the following situations:

- The tyre pressure has changed.
- The wheels or tyres have been changed or newly fitted.

On-board computer:

↪ Service ➤ Tyres

▶ Swipe downwards on Touch Control on the left-hand side of the steering wheel. The **Use current pressures as new reference values** message is shown in the multifunction display.

▶ Press the left-hand side of Touch Control on the steering wheel to initiate a restart. The **OK** message is shown in the multifunction display.

Current warning messages are deleted and the  yellow warning lamp goes out.

After you have driven for a few minutes, the system checks whether the current tyre pressures are within the specified range. The current tyre pressures are then accepted as reference values and monitored.

Make sure to observe the following further related subject:

- Notes on tyre pressure (→ page 303)



### Radio-equipment approval of the tyre pressure monitoring system

#### Radio equipment approval numbers

Country	Radio equipment approval number
Argentina	 CNC ID: H-20027
Australia	
Brazil	 MODELO: TSSRE4A ANATEL: 05181-17-06643 Este equipamento opera em caráter secundário, isto é, não tem direito à proteção contra-interferência prejudicial, mesmo de estações do mesmo tipo e não pode causar interferência a sistemas operando em caráter primário.
Canada	IC: 4008C-TSSRE4A Operation is subject to the following two conditions: (1) this device may not cause harmful interference, and (2) this device must accept any interference received, including interference that may cause undesired operation.

Country	Radio equipment approval number
European Union Iceland Norway	 Huf Hülbeck & Fürst GmbH & Co. KG hereby declare that the two-way radio system type TSSRE4A & TSSSG4G6 conforms to the directive 2014/53/EU. The complete text of the EU declaration of conformity is available at the following internet address: <a href="http://www.huf-group.com/eudoc">http://www.huf-group.com/eudoc</a> Waveband: 433.92 MHz Maximum transmission output emitted: <10 mW Manufacturer: Huf Electronics Bretten GmbH Gewerbestr. 40 75015 Bretten Germany
Indonesia	TSSRE4A & TSSSG4G6 52166/SDPPI/2017 3533
Israel	A. The use of this product does not need a wireless operation license. B. The product does not include an RF disturbance protection, and should not disturb other licensed products. C. It is forbidden to replace the antenna or to make any change in this product.

Country	Radio equipment approval number
Jordan	Kingdom of Jordan Type approval for Tyre Pressure Sensor and ECU Manufacturer: Huf Electronics Bretten GmbH Model: TSSRE4A Type Approval Number: TRC/LPD/2017/421 Model: TSSSG4G6 Type Approval Number: TRC/LPD/2017/422
Malaysia	 CIDF17000184 Model: TSSRE4A & TSSSG4G6 RAQP/57A/0817/S(17-2424)
Morocco	AGREE PAR L'ANRT MAROC Modele: TSSRE4A Numero d'agrement: MR 14320 ANRT 2017 Date d'agrement: 07/07/2017 Modele: TSSSG4G6 Numero d'agrement: MR 14319 ANRT 2017 Date d'agrement: 07/07/2017
Mexico	Model: TSSRE4A, IFETEL: RLVHUTS17-0806
Moldova	
Oman	OMAN - TRA R/4516/17 D100428
Philippines	 NTC Type Approved. No: ESD-1715393C

Country	Radio equipment approval number
Russia	
Singapore	Complies with IDA Standards DA103787
South Africa	 TA-2017/1393 TA-2017/1391
South Korea	 MSIP-CRM-HHF-TSSRE4A MSIP-CRM-HHF-TSSSG4G6 Applicant name: Huf Hüsbeck & Fürst GmbH & Co. KG Equipment name: Tire Pressure Monitoring System Manufacturing Year/Month: on the product Manufacturer: Huf Electronics Bretten GmbH Country of origin: Germany 해당 무선 설비 기기는 운용 중 전파혼신 가능성이 있으므로 인명안전과 관련된 서비스는 할 수 없음. (This device is not allowed to provide service related human body since it has possibility of frequency interference during on operation.)

Country	Radio equipment approval number
Taiwan	 <p>CCAO17LP0380T4 CCAO17LP0390T7</p> <p>經型式認證合格之低功率射頻電機,非經許可,公司、商號或使用者均</p> <p>不得擅自變更頻率、加大功率或變更原設計之特性及功能。低功率射</p> <p>頻電機之使用不得影響飛航安全及干擾合法通信;經發現有干擾現象</p> <p>時,應立即停用,並改善至無干擾時方得繼續使用。前項合法通信,指依</p> <p>電信法規定作業之無線電通信。低功率射頻電機須忍受合法通信或工</p> <p>業、科學及醫療用電波輻射性電機設備之干擾。</p> <p>According to “Administrative Regulations on Low Power Radio Waves Radiated Devices”.</p> <p>Without permission granted by the DGT, any company, enterprise, or user is not allowed to change frequency, enhance transmitting power or alter original characteristic as well as performance to a approved low power radio-frequency devices.</p> <p>The low power radio-frequency devices shall not influence aircraft security and interfere legal communications; If found, the user shall cease operating immediately until no interference is achieved.</p> <p>The said legal communications means radio communications is operated in compliance with the Telecommunications Act.</p> <p>The low power radio-frequency devices must be susceptible with the interference from legal com-</p>

Country	Radio equipment approval number
	<p>munications or ISM radio wave radiated devices.</p>
Thailand	<p>This telecommunication equipment conforms to NTC technical requirement.</p>
Ukraine	 <p>Model: TSSRE4A &amp; TSSSG4G6 UA.TR.109.0109-17</p>
United Arab Emirates	<p>Huf Electronics Bretten GmbH Model: TSSRE4A Model: TSSSG4G6 TRA Registered No: ER57807 / 17 Dealer No: DA36976 / 14 TRA Registered No: ER57806 / 17 Dealer No: DA36976 / 14</p>
USA	<p>FCC ID: YGOTSSRE4A</p> <p>This device complies with Part 15 of the FCC Rules. Operation is subject to the following two conditions: (1) this device may not cause harmful interference, and (2) this device must accept any interference received, including interference that may cause undesired operation.</p> <p>WARNING: Any changes or modification not expressly approved by the party responsible for compliance could void the user's authority to operate this equipment.</p>

### Changing a wheel

#### Notes on selecting, fitting and replacing tyres

You can ask for information regarding permitted wheel/tyre combinations at a qualified specialist workshop.

**⚠ WARNING** Risk of accident due to incorrect sizes of wheels and tyres

If wheels and tyres of the wrong size are used, the wheel brakes or wheel suspension components may be damaged.

- ▶ Always replace wheels and tyres with ones that fulfil the specifications of the original part.

For wheels, pay attention to the following:

- Designation
- Type
- Permissible wheel load
- Wheel offset

For tyres, pay attention to the following:

- Designation
- Manufacturer
- Type
- Load-bearing index
- Speed rating

**⚠ WARNING** Risk of injury through exceeding the specified tyre load-bearing capacity or the permissible speed rating

Exceeding the specified tyre load-bearing capacity or the permissible speed rating may lead to tyre damage and to the tyres bursting.

- ▶ Therefore, only use tyre types and sizes approved for your vehicle model.
- ▶ Observe the tyre load-bearing capacity rating and speed rating required for your vehicle.

**! NOTE** Vehicle and tyre damage through tyre types and sizes that have not been approved

For safety reasons, only use tyres, wheels and accessories which have been specially approved by Mercedes-Benz for your vehicle.

These tyres have been specially adapted for use with the control systems, such as ABS or ESP®.

Otherwise, certain properties, such as handling characteristics, vehicle noise, consumption, etc. could be adversely affected. Furthermore, other tyre sizes could result in the tyres rubbing against the body and axle com-

ponents when loaded. This could result in damage to the tyre or the vehicle.

- ▶ Only use tyres, wheels and accessories that have been checked and recommended by Mercedes-Benz.

**! NOTE** Risk to driving safety from retreaded tyres

Retreaded tyres are neither tested nor recommended by Mercedes-Benz, since previous damage cannot always be detected on retreaded tyres.

For this reason driving safety cannot be guaranteed.

- ▶ Do not use used tyres if you have no information about their previous usage.

**! NOTE** Damage to electronic component parts through the use of tyre-fitting tools

**Vehicles with tyre pressure monitoring system:** there are electronic component parts in the wheel. Tyre-fitting tools should not be applied in the area of the valve.

Otherwise, the electronic component parts could be damaged.

- ▶ Always have tyres changed at a qualified specialist workshop.

Accessories that are not approved for your vehicle by Mercedes-Benz, or are not being used correctly, can impair operating safety.

Before purchasing and using non-approved accessories, visit a qualified specialist workshop and enquire about:

- suitability
- legal stipulations
- factory recommendations

Observe the following when selecting, fitting and replacing tyres:

- Country-specific requirements for tyre approval that define a specific tyre type for your vehicle.

Furthermore, the use of certain tyre types in certain regions and areas of operation can be highly beneficial.

- Use only tyres and wheels of the same type, design (summer tyres, winter tyres, all-season tyres) and make.



- Only fit wheels of the same size and tread design on one axle (left and right).

It is only permissible to fit a different wheel size to this in the event of a flat tyre in order to drive to the specialist workshop.

- Only fit tyres of the correct size onto the wheels.
- Do not make any modifications to the brake system, the wheels or the tyres.

The use of wheel spacers or brake dust shields is not permitted and results in the invalidation of the vehicle's general operating permit.

- **Vehicles with a tyre pressure monitoring system:** all fitted wheels must be equipped with functioning sensors for the tyre pressure monitoring system.

- At temperatures below 10 °C, use winter tyres or all-season tyres marked M+S for all wheels.

Winter tyres bearing the  snowflake symbol in addition to the M+S marking provide the best possible grip in wintry road conditions.

- For M+S tyres, only use tyres with the same tread.
- Observe the maximum permissible speed for the M+S tyres fitted.

If this is below the vehicle's maximum speed, this must be indicated in an appropriate label in the driver's field of vision.

- Run in new tyres at moderate speeds for the first 100 km.
- Replace the tyres after six years at the latest, regardless of wear.

For more information on wheels and tyres, contact a qualified specialist workshop.

Be sure to also observe the following further related subjects:

- Notes on tyre pressure (→ page 303)
- Tyre pressure table
- Notes on the emergency spare wheel (→ page 327)

## Notes on changing wheels

**⚠ WARNING** Risk of injury through different wheel sizes

Interchanging the front and rear wheels if the wheels or tyres have different dimensions may severely impair the driving characteristics.

The disk brakes or wheel suspension components may also be damaged.

- ▶ Rotate front and rear wheels only if the wheels and tyres are of the same dimensions.

Interchanging the front and rear wheels if the wheels or tyres have different dimensions can render the general operating permit invalid.

On vehicles with the same front and rear wheel size, you can interchange the wheels every 5,000 to 10,000 km depending on the wear. Ensure the direction of rotation is maintained for the wheels.

It is imperative to observe the instructions and safety notes on "Changing a wheel" when doing so.

## Information on the direction of the tyres' rotation

Tyres with a specified direction of rotation have additional benefits, e.g. if there is a risk of aquaplaning. You will only gain these benefits if the correct direction of rotation is observed.

An arrow on the sidewall of the tyre indicates its correct direction of rotation.

You may also fit a spare wheel against the direction of rotation. Observe the time restriction on use as well as the speed limitation specified on the spare wheel.

## Information on storing wheels

- Wheels that have been removed should be stored in a cool, dry and, if possible, dark place.
- Protect the tyres from oil, grease and fuel.

## Overview of the tyre-change tool kit

Necessary tyre-change tool kit may include, for example:

- jack

- wheel spanner
- i** You will find the maximum load capacity of the jack stated on the adhesive label attached to the jack. The jack is maintenance-free. If there is a malfunction, please contact a qualified specialist workshop.

### Vehicles with rear wheel drive

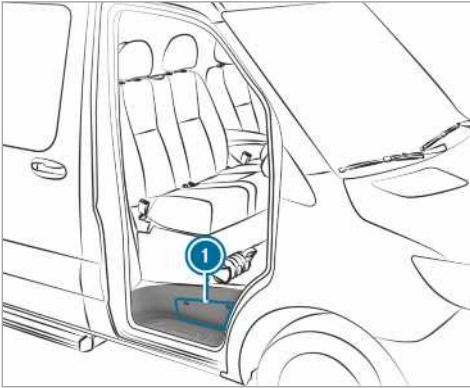

The tyre-change tool kit **1** is located in the stowage compartment above the step of the co-driver's door and in the stowage compartment in the footwell on the co-driver side.

### Vehicles with front wheel drive



The tyre-change tool kit **1** is located behind the driver's seat.

### Preparing the vehicle for a wheel change

#### Requirements:

- The tyre-change tool kit is available.
- The vehicle is not on a slope.
- The vehicle is on solid, non-slippery and level ground.

- ▶ Apply the parking brake.

- ▶ Move the front wheels to the straight-ahead position.
- ▶ **Vehicles with manual transmission:** engage first or reverse gear **[R]**.
- ▶ **Vehicles with automatic transmission:** shift the transmission to position **[P]**.
- ▶ Switch off the engine.
- ▶ Make sure that the engine cannot be started.
- ▶ Take the vehicle tool kit from the footwell on the co-driver side (→ page 299).

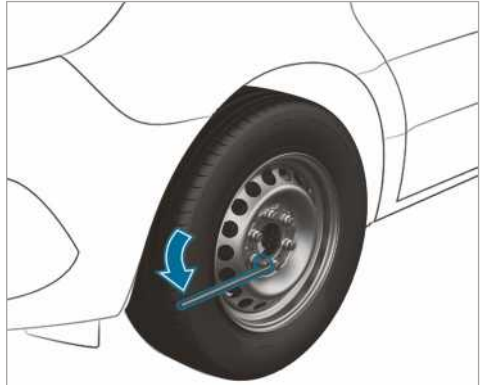

### Vehicles with rear wheel drive

- ▶ Take the jack and the tyre-change tool kit out of the stowage compartment (→ page 320).
- ▶ If necessary, remove the hub cap.
- ▶ Assemble the wheel wrench extension using the middle rod and the rod with the largest diameter from the three-piece jack pump lever.
- ▶ Starting with the middle rod, slide the wheel wrench extension as far as it will go onto the wheel wrench.
- ▶ Using the wheel wrench, loosen the wheel nuts/bolts on the wheel you wish to change by about one full turn. Do not unscrew the wheel bolts/nuts completely.
- ▶ Raise the vehicle (→ page 322).

### Vehicles with front wheel drive

- ▶ Take the jack and the tyre-change tool kit from behind the driver's seat (→ page 320).
- ▶ If necessary, remove the hub cap.
- ▶ Using the wheel wrench, loosen the wheel nuts/bolts on the wheel you wish to change

by about one full turn. Do not unscrew the wheel bolts/nuts completely.

► Raise the vehicle (→ page 322).

### Raising the vehicle when changing a wheel

#### **▲ WARNING** Risk of injury from jack tipping

If you park a vehicle with air suspension, the air suspension may remain activated for up to one hour, even when the ignition is switched off. If you then raise the vehicle with the jack, the air suspension will attempt to adjust the vehicle level.

The jack may tip.

- Press the Service button on the air suspension remote control before raising the vehicle. This prevents automatic readjustment of the vehicle level and prevents it from being raised or lowered manually.

#### **▲ WARNING** Risk of injury from incorrect positioning of the jack

If you do not position the jack correctly at the appropriate jacking point of the vehicle, the jack could tip with the vehicle raised.

- Only position the jack at the appropriate jacking point of the vehicle. The base of the jack must be positioned vertically under the jacking point of the vehicle.

#### **▲ WARNING** Risk of injury from vehicle tipping

On slopes, the jack could tip with the vehicle raised.

- Never change a wheel on a slope.
- Consult a qualified specialist workshop.

#### **! NOTE** Vehicle damage from the jack

If you do not position the jack correctly at the appropriate jack support point of the vehicle, the jack could tip over with the vehicle raised.

- The jack is designed exclusively for jacking up the vehicle at the jack support points.

- The vehicle is prepared for changing a wheel (→ page 321).

Only position the jack on the jacking points intended for this purpose. You could otherwise damage the vehicle.

Important notes on using the jack:

- Only use the vehicle-specific jack that has been tested and approved by Mercedes-Benz to raise the vehicle. If the jack is used incorrectly, it could tip over while the vehicle is raised.
- The jack is designed only to raise the vehicle for a short time while a wheel is being changed and is not suitable for carrying out maintenance work under the vehicle.
- Avoid changing a wheel on uphill and downhill slopes.
- The jack must be placed on a firm, flat and non-slip surface. If necessary, use a large, flat, load bearing and non-slip underlay.
- The base of the jack is positioned vertically under the jacking point.

Safety instructions while the vehicle is raised:

- Do not put your hands or feet under the vehicle.
- Do not lie underneath the vehicle.
- Do not start the engine and do not release the parking brake.
- Do not open or close any doors.

### Vehicles with front-wheel drive

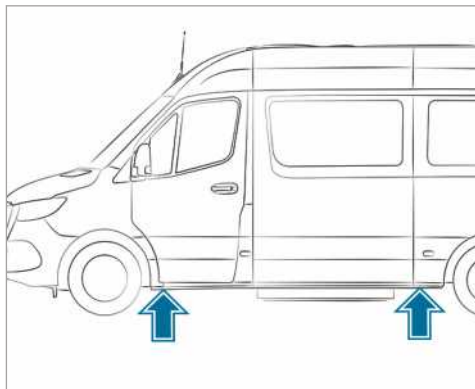

Jacking points

### Requirements:

- There are no persons in the vehicle.

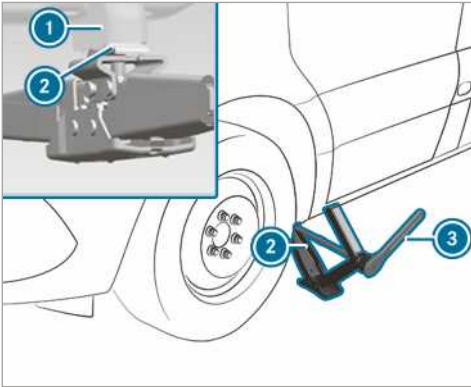

Jacking point, front axle

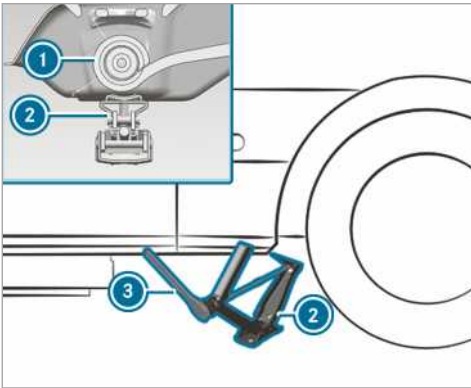

Jacking point, rear axle

- ▶ If necessary, turn the head of the jack.
- ▶ Position jack ② at jacking point ①.
- ▶ Turn the handwheel until the plate of the jack sits securely on jacking point ①.
- ▶ **Front axle:** position ratchet ring spanner ③ from the tyre-change tool kit on the hexagon nut of the jack so that the lettering "AUF" is visible.
- ▶ **Rear axle:** position the extension rod and the socket wrench from the tyre-change tool kit on the hexagon nut of the jack and position ratchet ring spanner ③ from the tyre-change tool kit on the extension rod until the lettering "AUF" is visible.
- ▶ Turn ratchet ring spanner ③ clockwise until jack ② sits completely on jacking point ①

and the base of the jack lies evenly on the ground.

- ▶ Turn ratchet ring spanner ③ until the tyre is raised a maximum of 3 cm off the ground.
- ▶ Loosen and remove the wheel (→ page 324).

### Vehicles with rear-wheel drive

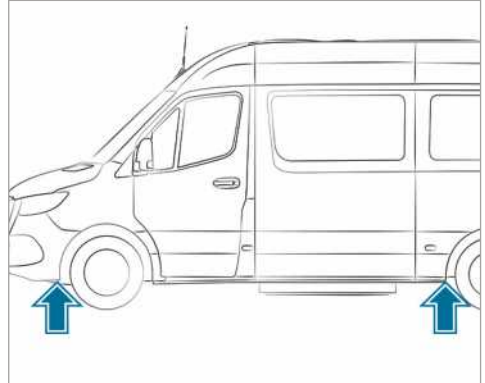

Jacking points

Only use the middle rod and the pump lever rod with the largest diameter for the jack as a wheel wrench extension. Only insert the middle rod on the wheel wrench, and always as far as it will go. Otherwise, the rods could bend and deform so much that they can no longer be used as pump levers for the jack.

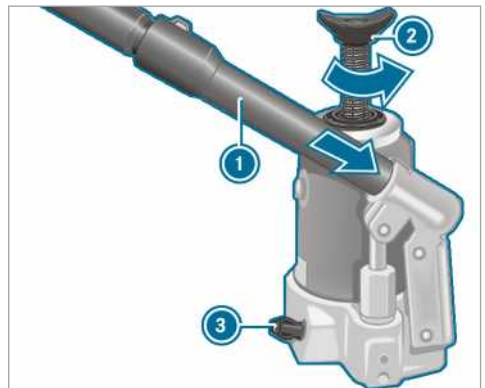

- ▶ **To prepare the hydraulic jack:** insert the third rod of pump lever ① for the jack into the wheel wrench extension.
- ▶ Close pressure release screw ③.

▶ To do this, use the flattened section on pump lever ❶ to turn pressure release screw ❸ clockwise to the stop.

❶ Do not turn pressure release screw ❸ more than one or two full turns. Hydraulic fluid could otherwise escape.

▶ Insert pump lever ❶ with the largest rod into the recess on the jack and secure by turning it clockwise.

▶ Place the jack vertically beneath the jacking points described below.

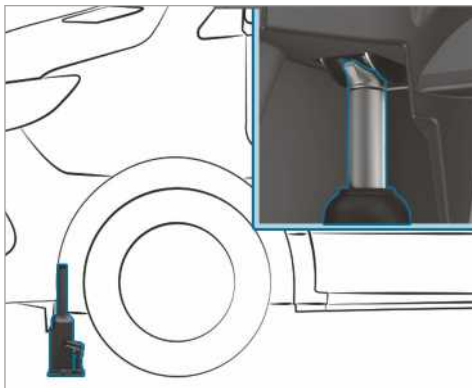

Jacking point, front axle

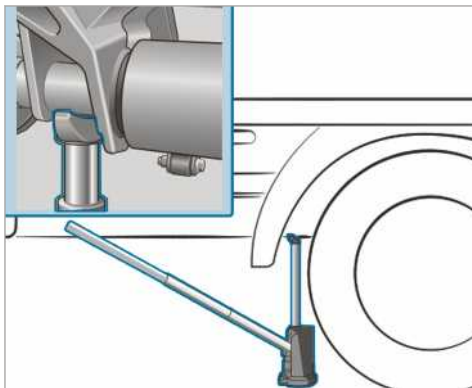

Jacking point, rear axle (example: platform vehicle up to 3.5 t)

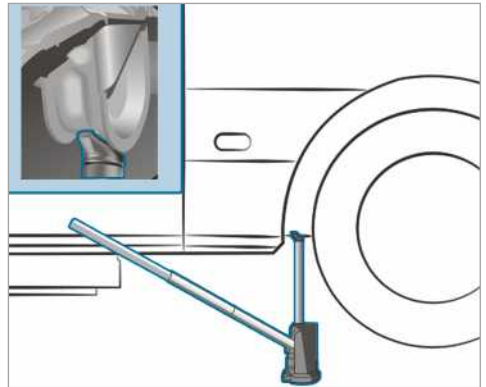

Jacking point, rear axle (example: panel van and crewbus up to 4.0 t)

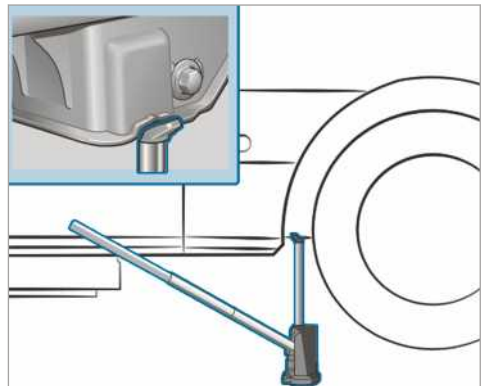

Jacking point, rear axle (vehicles 5.0 t)

- ▶ Place the jack beneath the jacking point in front of the front axle.
- ▶ **Vehicles with all-wheel drive:** unscrew jack spindle ❷ anti-clockwise as far as it will go.
- ▶ Raise the vehicle until the tyre is raised a maximum of 3 cm off the ground.
- ▶ Loosen and remove the wheel (→ page 324).

## Removing a wheel

### Requirements:

- The vehicle is raised (→ page 322).

When changing a wheel, avoid applying any force to the brake discs since this could impair the level of comfort when braking.

**!** **NOTE** Damage to threading from dirt on wheel bolts

► Do not place wheel bolts in sand or on a dirty surface.

- Unscrew the wheel bolts or nuts with the wheel nut wrench.
- On front wheels with wheel nuts, remove the wheel nut cover.
- Remove the wheel.

### Fitting a new wheel

#### Requirements:

- The wheel is removed (→ page 324).

**!** **WARNING** Risk of accident from losing a wheel

Oiled, greased or damaged wheel bolt/wheel nut threads or wheel hub/wheel mounting bolt threads can cause the wheel bolts/wheel nuts to come loose.

As a result, you could lose a wheel while driving.

- Never oil or grease the threads.
- In the event of damage to the threads, contact a qualified specialist workshop immediately.
- Have the damaged wheel bolts or damaged hub threads replaced.
- Do not continue driving.

**!** **WARNING** Risk of injury from tightening wheel bolts and nuts

If you tighten the wheel bolts or wheel nuts when the vehicle is raised, the jack could tip.

- Only tighten wheel bolts or wheel nuts when the vehicle is on the ground.
- Observe the information on the choice of tyres (→ page 318).
- For safety reasons, only use wheel bolts or wheel nuts which have been approved by Mercedes-Benz and for the wheel in question.

When you fit the steel spare wheel, it is essential you use short wheel bolts for a steel wheel. Using other wheel bolts when fitting the steel spare wheel may lead to damage to the brake system.

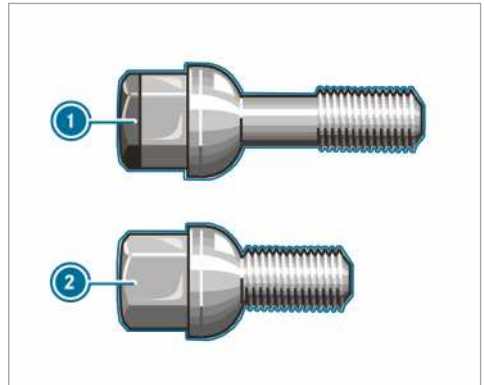

① Wheel bolt for light-alloy wheel

② Wheel bolt for steel wheel

- Clean the wheel and wheel hub contact surfaces.
- **Vehicles with Super Single tyres:** first fit the adapter for the narrow spare wheel on the wheel hub.
- Slide the wheel which is to be refitted onto the wheel hub or the adapter for the spare wheel and push it on.
- Slide the wheel which is to be refitted onto the wheel hub and push it on.

#### Wheels centred using the wheel bolts:

- Vehicles with light-alloy wheels: use the short wheel bolts for the steel spare wheel from the vehicle tool kit.
- Screw in the wheel bolts until they are finger-tight.

#### Wheels with wheel nuts:

- Front wheels with wheel nut cover: press the wheel nut cover onto the wheel nuts.
- Screw in three wheel nuts over the fixing discs of the wheel nut cover.
- Turn the wheel so that the wheel bolts are in the middle of the holes.
- Screw in the remaining wheel nuts.
- Slightly tighten all the wheel nuts.

### Lowering the vehicle after a wheel change

#### **▲ WARNING** Risk of injury through incorrect tightening torque

The wheels could come loose if the wheel bolts or wheel nuts are not tightened to the prescribed tightening torque.

- ▶ Have the tightening torque checked immediately at a qualified specialist workshop after changing a wheel.

#### Requirements:

- The new wheel has been fitted (→ page 325).

#### Vehicles with front-wheel drive

- ▶ **Front axle:** position the ratchet ring spanner from the tyre-change tool kit on the hexagon nut of the jack so that the lettering "AB" is visible.
- ▶ **Rear axle:** position the extension rod from the tyre-change tool on the hexagon nut of the jack and position the ratchet ring spanner from the tyre-change tool kit on the extension rod until the lettering "AB" is visible.
- ▶ **To lower the vehicle:** turn the ratchet ring spanner of the jack anti-clockwise.

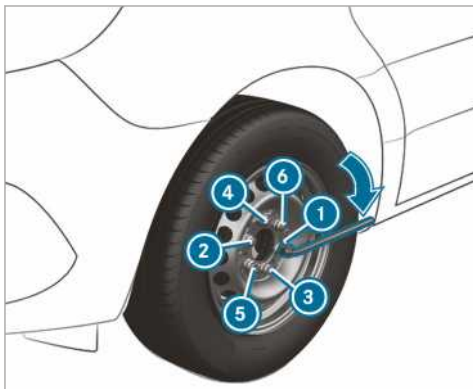

- ▶ Tighten the wheel bolts or nuts evenly in the sequence indicated (1 to 6).

Specified tightening torque:

- Steel wheel bolts: 240 Nm
- Wheel nuts 180 Nm
- Light-alloy wheel bolts: 180 Nm

#### **▲ WARNING** Risk of injury through incorrect tightening torque

The wheels could come loose if the wheel bolts or wheel nuts are not tightened to the prescribed tightening torque.

- ▶ Have the tightening torque checked immediately at a qualified specialist workshop after changing a wheel.

#### Vehicles with rear-wheel drive

Only use the middle rod and the pump lever rod with the largest diameter for the jack as a wheel wrench extension. Only insert the middle rod on the wheel wrench, and always as far as it will go. Otherwise, the rods could bend and deform so much that they can no longer be used as pump levers for the jack.

Vehicles with Super Single tyres: if you mount the spare wheel to the rear axle, do not exceed the maximum speed of 55 km/h and the maximum distance of 100 km. Otherwise, the transmission could be damaged due to the different rotational speeds of the wheels.

- ▶ Using the pump lever, slowly turn the lowering screw on the jack approximately one revolution and carefully lower the vehicle.
- ▶ Place the jack to one side.
- ▶ Pull the rod with the smallest diameter off the pump lever. The shortened pump lever serves as a wheel wrench extension.
- ▶ Starting with the middle rod, slide the wheel wrench extension as far as it will go onto the wheel wrench.

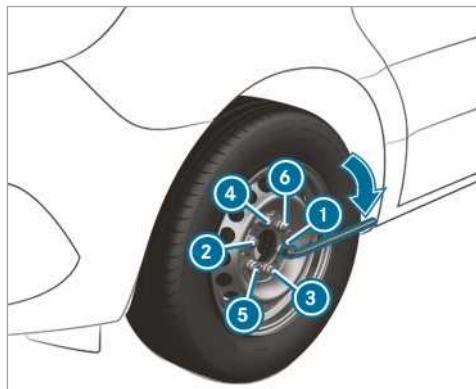



- ▶ Tighten the wheel bolts or nuts evenly in the sequence indicated (❶ to ❷).

Specified tightening torque:

- Steel wheel bolts: 240 Nm
- Wheel nuts 180 Nm
- Light-alloy wheel bolts: 180 Nm

**⚠ WARNING** Risk of injury through incorrect tightening torque

The wheels could come loose if the wheel bolts or wheel nuts are not tightened to the prescribed tightening torque.

- ▶ Have the tightening torque checked immediately at a qualified specialist workshop after changing a wheel.

- ▶ Push the piston on the hydraulic jack in again and close the pressure release screw.

- ▶ **Vehicles with all-wheel drive:** turn the jack spindle clockwise as far as it will go.

- ❶ You can now fit the hub caps on steel wheels with wheel bolts. The fitting procedure depends on whether the hub cap acts as a trim that covers the whole wheel, or just covers the centre.

- ▶ Wheel with hub cap: position the opening for the tyre valve in the hub cap over the tyre valve.

- ▶ Push the edge of the hub cap onto the wheel rim with both hands until it engages into place. Make sure the hub cap retaining catches engage on the steel wheel.

- ▶ **Wheel with central hub cap:** position the retaining lugs of the central hub cap over the wheel bolts.

- ▶ Hit the middle of the hub cap to engage it on the wheel.

- ▶ Secure the faulty wheel in the spare wheel bracket.

- ▶ **Vehicles with Super Single tyres:** transport the defective rear wheel in the load area. The rear wheel is too large for the spare wheel bracket.

- ▶ Check the tyre pressure of the newly fitted wheel and adjust it if necessary.

- ▶ Retighten the wheel bolts or wheel nuts to the specified tightening torque after the vehicle has been driven 50 km.

- ▶ When using a wheel or spare wheel with a new or newly painted wheel rim, have the wheel bolts or nuts retightened after approximately 1,000 km to 5,000 km.

- ❶ **Vehicles with the tyre pressure monitor system:** all fitted wheels must be equipped with functioning sensors.

Make sure to observe the following further related subject:

- Notes on tyre pressure (→ page 303)

## Spare wheel

### Notes on the spare wheel

**⚠ WARNING** Risk of accident caused by incorrect wheel and tyre dimensions

Wheel and tyre dimensions as well as the type of tyre may vary between the spare wheel and the wheel to be replaced. When the spare wheel is fitted, driving characteristics may be severely affected.

To prevent hazardous situations:

- ▶ Adapt your driving style accordingly and drive carefully.
- ▶ Never fit more than one spare wheel that differs from the wheel to be replaced.
- ▶ Only use the spare wheel that differs from the wheel to be replaced for a short time.
- ▶ Do not switch off ESP®.
- ▶ Have the spare wheel of a different size replaced at the nearest qualified specialist workshop. The wheel and tyre must have the correct dimensions and the tyre must be the correct type.

When using a spare wheel of a different size, do not exceed the maximum speed of 80 km/h.

**⚠ WARNING** Risk of accident from damaged spare wheel with Super Single tyres

### Vehicles with Super Single tyres

The tyre of the spare wheel is under above-average strain after being fitted on the rear axle. If you exceed the maximum speed or the maximum distance, or fit the spare wheel again, the tyre of the spare wheel may be



damaged. The tyre damage may not be visible and not detectable.

A damaged tyre may cause a loss of tyre pressure. This could cause you to lose control of the vehicle.

- ▶ Only use the spare wheel if it has not yet been fitted on the rear axle with the current tyres.
- ▶ If the spare wheel had been fitted on the rear axle, have the tyre of the spare wheel replaced after changing the wheel again, irrespectively of the distance.
- ▶ For safety reasons, when changing a tyre ensure that only the tyre valve type approved for the tyres is used.

**NOTE** Damage to the transmission

**Vehicles with Super Single tyres:** when you fit the spare wheel on the rear axle, the transmission may be damaged by the different rotational speeds of the wheels.

- ▶ When the spare wheel is fitted on the rear axle, keep to the maximum speed of 55 km/h and the maximum distance of 100 km.

- i** It is possible, without restrictions, to use the spare wheel only on the front axle of a vehicle with Super Single tyres.

Regularly check the spare wheel is sitting securely and has the specified tyre pressure.

The following should be checked regularly, particularly prior to long journeys:

- the tyre pressure of the spare wheel (adjust the tyre pressure if necessary)
- the fastenings of the spare wheel holder

Replace the tyres after six years at the latest, regardless of wear. This also applies to the spare wheel.

- i** If you have fitted a spare wheel, the tyre pressure monitor will not function for this wheel. The spare wheel is not equipped with a sensor for monitoring tyre pressure.

## Fitting/removing the spare wheel

### Vehicles with front wheel drive: removing the spare wheel

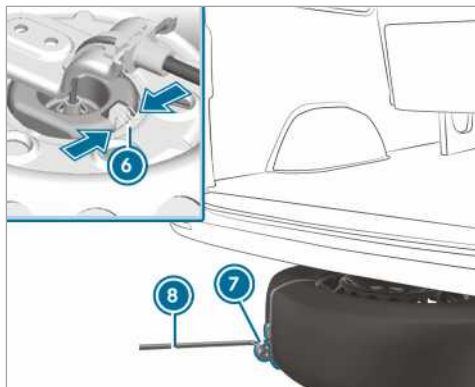
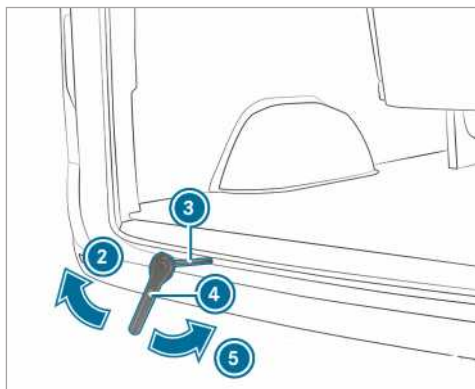
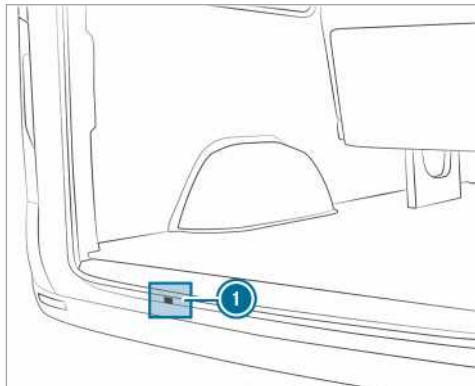

- ▶ Open the rear-end doors.

- ▶ Take ratchet ring spanner ④ and auxiliary tool ③ for the spare wheel lifter out of the vehicle tool kit.
- ▶ Push auxiliary tool ③ through opening ① into the winch guide.
- ▶ Place ratchet ring spanner ④ onto auxiliary tool ③ for the spare wheel lifter so that the letters "AB" are visible.
- ▶ Turn ratchet ring spanner ④ in the direction of arrow ② until you feel resistance or until the friction clutch of the winch overwinds.
- ▶ Hook wheel wrench ⑧ into the loop of extraction device ⑦ on the spare wheel and pull the spare wheel out from under the vehicle.
- ▶ Press spring ⑥ together on the wheel gripper and release the wheel gripper from the spare wheel.
- ▶ Remove spare wheel extraction device ⑦ and store it in a safe place.

Check that the spare wheel is correctly and firmly positioned:

- after every wheel change
- at every maintenance interval
- at least once a year

### Vehicles with front wheel drive: fitting the spare wheel

- ① Light-alloy wheels cannot be transported under the vehicle. In this case, transport the light-alloy wheel in the load compartment.
- ▶ Take ratchet ring spanner ④ and auxiliary tool ③ for the spare wheel lifter out of the vehicle tool kit.
- ▶ Push auxiliary tool ③ through opening ① into the winch guide.
- ▶ Secure extraction device ⑦ to the wheel.
- ▶ Place the wheel on the ground with the wheel brace pointing upwards.
- ▶ Align the wheel so that the loop of extraction device ⑦ points backwards.
- ▶ Guide the wheel gripper at an angle on the wire into the wheel brace.
- ▶ Slide the wheel under the vehicle a little.
- ▶ Place ratchet ring spanner ④ onto auxiliary tool ③ for the spare wheel lifter so that the letters "AUF" are visible.

- ▶ Turn ratchet ring spanner ④ in the direction of arrow ⑤ until you feel resistance or until the friction clutch of the winch overwinds.
- ▶ Pull wheel wrench ④ and auxiliary tool ③ for the spare wheel lifter out of the opening for the winch and stow them in the vehicle tool kit.
- ▶ Close the rear-end doors.

### Vehicles with rear wheel drive: removing the spare wheel (panel van/crewbus)

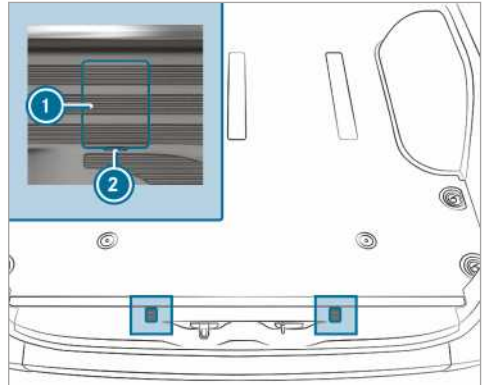

Bolt covers for the safety hooks (example: panel van)

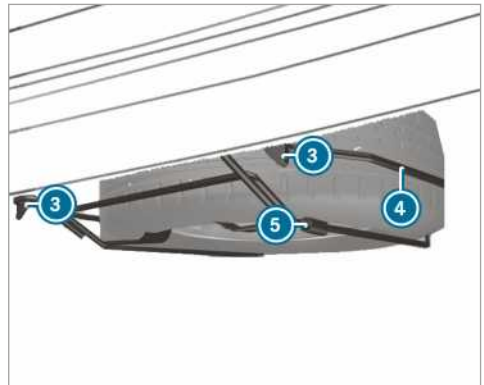

- ▶ Open the rear-end doors.
- ▶ Place a screwdriver into recesses ② and then prise off covers ①.
- ▶ Using the wheel wrench from the vehicle tool kit, unscrew the now visible bolts anti-clockwise by approximately 20 turns.

- ▶ Slightly raise spare wheel carrier ④ and unhook left-hand safety hook ③.
- ▶ Assemble the pump lever for the jack and slide it into sleeve ⑤ on the right-hand side of spare wheel carrier ④.
- ▶ Raise spare wheel carrier ④ with the pump lever and unhook right-hand safety hook ③.
- ▶ Slowly lower spare wheel carrier ④ to the ground.
- ▶ Lift spare wheel carrier ④ slightly and pull the pump lever out of the sleeve.
- ▶ Use the pump lever to lift the spare wheel beyond the rear edge of spare wheel carrier ④.
- ▶ Carefully remove the spare wheel from spare wheel carrier ④. The spare wheel is heavy. When the spare wheel is removed, the centre of gravity changes due to the heavy weight of the wheel. The spare wheel may slip down or tip over.

#### Vehicles with rear wheel drive: fitting the spare wheel (panel van/crewbus)

- ▶ Carefully place the spare wheel onto spare wheel carrier ④. The spare wheel is heavy. When you place the spare wheel onto spare wheel carrier ④, the centre of gravity changes due to the weight of the wheel. The spare wheel may slip down or tip over.
- ▶ Slide the pump lever for the jack into sleeve ⑤ on spare wheel carrier ④.
- ▶ Raise spare wheel carrier ④ with the pump lever and attach right-hand safety hook ③.
- ▶ Slightly raise spare wheel carrier ④ and attach left-hand safety hook ③.
- ▶ Pull the pump lever out of sleeve ⑤.
- ▶ Using the wheel wrench, tighten safety hook bolts ③ by turning them clockwise.
- ▶ Replace and engage covers ①.
- ▶ Close the rear-end doors.

#### Vehicles with rear wheel drive: removing the spare wheel (vehicle with lowered chassis)

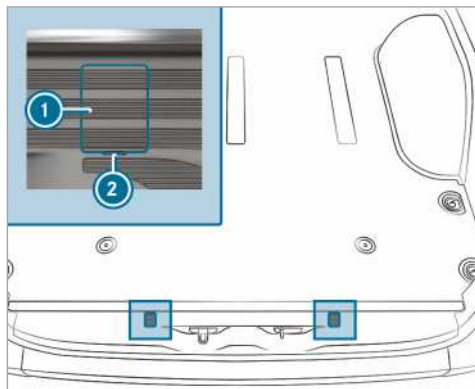

Bolt covers for the safety hooks (example: panel van)

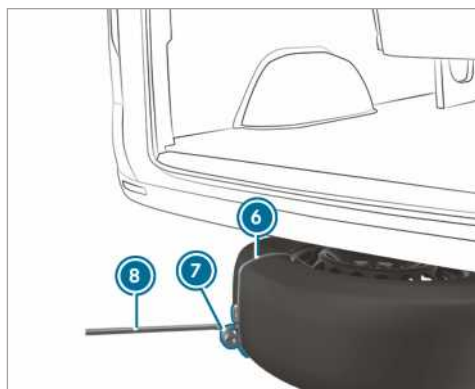
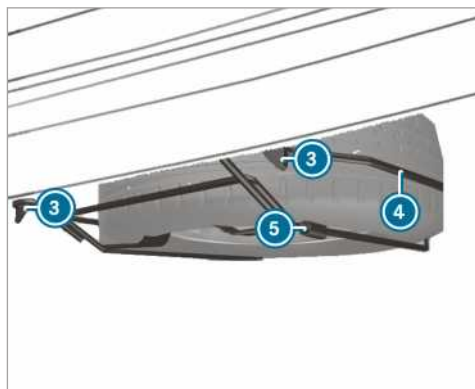

- ▶ Open the rear-end doors.

- ▶ Place a screwdriver into recesses ② and then prise off covers ①.
- ▶ Using the wheel wrench from the vehicle tool kit, unscrew the now visible bolts anti-clockwise by approximately 20 turns.
- ▶ Slightly raise spare wheel carrier ④ and unhook left-hand safety hook ③.
- ▶ Assemble the pump lever for the jack and slide it into sleeve ⑤ on the right-hand side of spare wheel carrier ④.
- ▶ Raise the spare wheel carrier with the pump lever and unhook right-hand safety hook ③.
- ▶ Position loop ⑦ of extraction device ⑥ on the spare wheel so that you will later be able to attach wheel wrench ⑧.
- ▶ Prepare the jack.
- ▶ Place the jack beneath the corresponding jack support point.
- ▶ Move the pump lever up and down until the tyre is raised a maximum of 3 cm off the ground.
- ▶ Hook wheel wrench ⑧ into loop ⑦ of extraction device ⑥ on the spare wheel.
- ▶ Carefully remove the spare wheel from spare wheel carrier ④. The spare wheel is heavy. When the spare wheel is removed, the centre of gravity changes due to the heavy weight of the wheel. The spare wheel may slip down or tip over.
- ▶ Remove the spare wheel extraction device and store it in a safe place. You can now fit the spare wheel to your vehicle.
- ▶ Lower the vehicle.

### Vehicles with rear wheel drive: fitting the spare wheel (vehicle with lowered chassis)

- ① In the event of a flat tyre, you may store the defective wheel inside the vehicle only. An intact wheel may be stored in the spare wheel carrier only when the vehicle is unladen. A laden vehicle must first be raised.
- ▶ Carefully place the spare wheel onto spare wheel carrier ④. The spare wheel is heavy. When you place the spare wheel onto spare wheel carrier ④, the centre of gravity changes due to the weight of the wheel. The spare wheel may slip down or tip over.
- ▶ Slide the pump lever for the jack into sleeve ⑤ on spare wheel carrier ④.

- ▶ Raise spare wheel carrier ④ with the pump lever and attach right-hand safety hook ③.
- ▶ Slightly raise spare wheel carrier ④ and attach left-hand safety hook ③.
- ▶ Pull the pump lever out of sleeve ⑤.
- ▶ Using the wheel wrench, tighten safety hook bolts ⑤ by turning them clockwise.
- ▶ Replace and engage covers ①.
- ▶ Close the rear-end doors.

### Removing the spare wheel in the load compartment

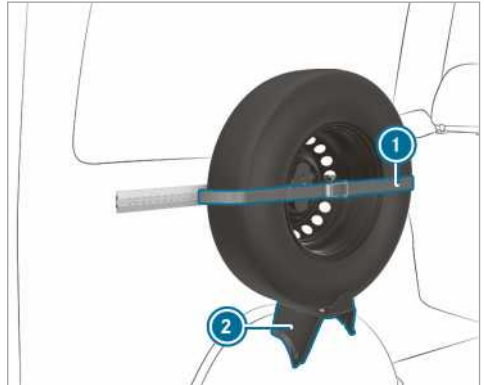

- ▶ Release clamping strap ① by opening the ratchet.
- ▶ Carefully remove the spare wheel from bracket ②.

### Fitting the spare wheel in the load compartment

- ▶ Place the spare wheel in bracket ② and press it onto the wall.
- ▶ Tighten clamping strap ① with the ratchet.

### Vehicles with rear wheel drive: removing the spare wheel (chassis)

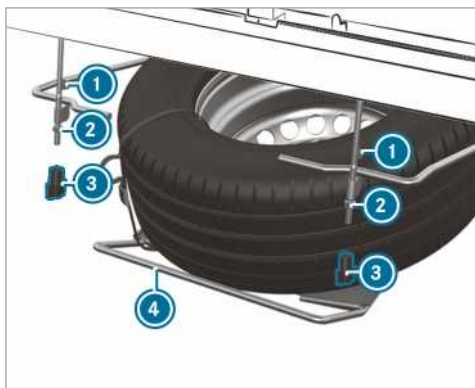

- ▶ Slide the pump lever for the jack into the sleeve on spare wheel carrier (4).
  - ▶ Raise spare wheel carrier (4) with the pump lever and attach right-hand safety hook (1).
  - ▶ Slightly raise the spare wheel carrier and attach left-hand safety hook (1).
  - ▶ Pull the pump lever out of the sleeve.
  - ▶ Tighten nuts (2).
  - ▶ Put wing nuts (3) in place and tighten them.
- 
- ▶ Loosen wing nuts (3) manually and then remove them.
  - ▶ Loosen nuts (2) as far as the thread end.
  - ▶ Slightly raise spare wheel carrier (4) and unhook left-hand safety hook (1).
  - ▶ Assemble the pump lever for the jack and slide it into the sleeve on the right-hand side of spare wheel carrier (4).
  - ▶ Raise spare wheel carrier (4) with the pump lever and unhook right-hand safety hook (1).
  - ▶ Slowly lower spare wheel carrier (4) to the ground.
  - ▶ Lift spare wheel carrier (4) slightly and pull the pump lever out of the sleeve.
  - ▶ Use the pump lever to lift the spare wheel beyond the rear edge of the spare wheel carrier.
  - ▶ Carefully remove the spare wheel from the spare wheel carrier. The spare wheel is heavy. When the spare wheel is removed, the centre of gravity changes due to the heavy weight of the wheel. The spare wheel may slip down or tip over.

### Vehicles with rear wheel drive: fitting the spare wheel (chassis)

- ▶ Carefully place the spare wheel onto spare wheel carrier (4). The spare wheel is heavy. When you place the spare wheel onto the spare wheel carrier, the centre of gravity changes due to the weight of the wheel. The spare wheel may slip down or tip over.

### Information on technical data

The technical data was determined in accordance with EU Directives. The given data only applies to vehicles with standard equipment. Further information can be obtained at a qualified specialist workshop.

**Only for certain countries:** you can find vehicle-specific vehicle data in the COC documents (CERTIFICATE OF CONFORMITY). These documents are supplied when the vehicle is delivered.

### On-board electronics

#### Notes on work on the engine electronics

**!** **NOTE** Work carried out incorrectly can result in damage to the engine electronics

Work carried out incorrectly on the engine electronics can damage vehicle components and invalidate the vehicle's general operating permit.

- ▶ Always have work on the engine electronics and related components carried out at a qualified specialist workshop.

### Two-way radios

#### Installation notes for two-way radios

**!** **WARNING** Risk of accident due to improper work on two-way radios

The electromagnetic radiation from two-way radios can interfere with the on-board electronics if RF transmitters are manipulated or retrofitted incorrectly.

This could jeopardise the operating safety of the vehicle.

- ▶ You should have all work on electrical and electronic components carried out at a qualified specialist workshop.

**!** **WARNING** Risk of accident from incorrect operation of two-way radios

If you operate two-way radios incorrectly in the vehicle, the electromagnetic radiation could interfere with the on-board electronics, e.g.:

- if the two-way radio is not connected to an exterior aerial
- if the exterior aerial is not correctly mounted or is not of low reflection

This could jeopardise the operating safety of the vehicle.

- ▶ Have the low-reflection exterior aerial fitted at a qualified specialist workshop.
- ▶ When operating two-way radios in the vehicle, always connect them to the low-reflection exterior aerial.

**!** **NOTE** Invalidation of the operating permit due to failure to comply with the instructions for installation and use

The operating permit may be invalidated if the instructions for installation and use of two-way radios are not observed.

- ▶ Only use approved frequency bands.
- ▶ Observe the maximum permissible output power in these frequency bands.
- ▶ Only use approved aerial positions.

Use Technical Specification ISO/TS 21609 (Road Vehicles - EMC guidelines for installation of after-market radio frequency transmitting equipment) when retrofitting two-way radios. Comply with the legal requirements for detachable parts.

If your vehicle has fittings for two-way radio equipment, use the power supply or aerial connections intended for use with the fittings. Observe the manufacturer's supplement during installation.

#### Information on two-way radio transmission output

The maximum transmission outputs (PEAK) at the base of the aerial must not exceed the values in the following table:

#### Frequency band and maximum transmission output

Frequency band	Maximum transmission output
Short wave 3 - 54 MHz	100 W
4 m waveband 74 - 88 MHz	30 W

Frequency band	Maximum transmission output
2 m waveband 144 - 174 MHz	50 W
Trunked radio system/Tetra 380 - 460 MHz	10 W
70 cm waveband 420 - 450 MHz	35 W
Two-way radio (2G/3G/4G)	10 W

The following can be used in the vehicle without restrictions:

- two-way radios with a maximum transmission output of up to 100 mW
- two-way radios with transmitter frequencies in the 380 - 410 MHz frequency band and a maximum transmission output of up to 2 W (trunked radio system/Tetra)
- mobile phones (2G/3G/4G)

There are no restrictions when positioning the aerial on the outside of the vehicle for the following frequency bands:

- Trunked radio system/Tetra
- 70 cm waveband
- 2G/3G/4G

**Vehicle identification plate, vehicle identification number (VIN) and engine number**

**Vehicle identification plate**

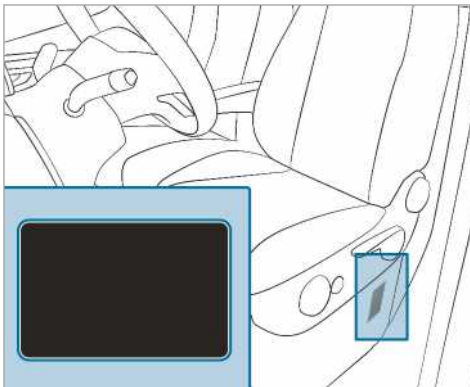

Depending on the vehicle model, the vehicle identification plate is located on the seat base of the driver's seat or on the B-pillar.

- ① The data is vehicle-specific and can differ from that shown. Always observe the specifications on your vehicle's identification plate.



Vehicle identification plate (example: Gulf States)

- ① Vehicle manufacturer
- ② VIN (vehicle identification number)
- ③ Maximum gross vehicle weight
- ④ Permissible front axle load (kg)
- ⑤ Permissible rear axle load (kg)
- ⑥ Engine type
- ⑦ Date of manufacture

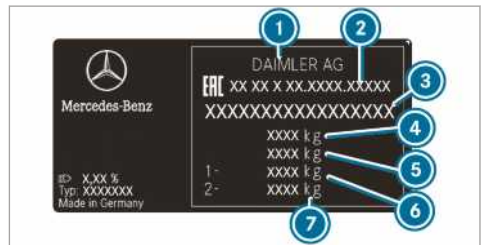

Vehicle identification plate (example: Russia)

- ① Vehicle manufacturer
- ② Type approval number
- ③ VIN (vehicle identification number)
- ④ Maximum gross vehicle weight (kg)
- ⑤ Maximum gross weight of vehicle/trailer combination (kg) (only for certain countries)
- ⑥ Permissible front axle load (kg)
- ⑦ Permissible rear axle load (kg)



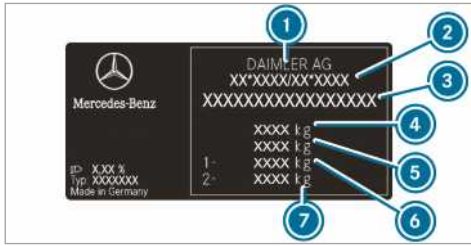

Vehicle identification plate (example: all other countries)

- ① Vehicle manufacturer
- ② EU general operating permit number (only for certain countries)
- ③ VIN (vehicle identification number)
- ④ Maximum gross vehicle weight (kg)
- ⑤ Maximum gross weight of vehicle/trailer combination (kg) (only for certain countries)
- ⑥ Permissible front axle load (kg)
- ⑦ Permissible rear axle load (kg)

The vehicle identification plate may also contain the following data:

- payload
- kerb weight
- number of passenger seats

#### VIN engraved underneath the bonnet

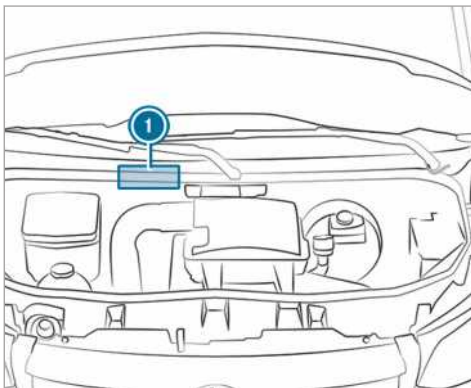

Engraved VIN ① is located underneath the bonnet.

#### VIN underneath the windscreen



The VIN is also attached as a label on the lower section of windscreen ②.

The VIN underneath the windscreen is only available for certain countries.

#### Engine number

The engine number is stamped onto the crankcase. You can obtain further information from any qualified specialist workshop.

### Operating fluids and capacities

#### Notes on operating fluids

**⚠ WARNING** Risk of injury from operating fluids harmful to your health

Operating fluids may be poisonous and harmful to your health.

- ▶ Observe the text on the original containers when using, storing or disposing of operating fluids.
- ▶ Always store operating fluids sealed in their original containers.
- ▶ Always keep children away from operating fluids.

**🔥 ENVIRONMENTAL NOTE** Environmental pollution caused by environmentally irresponsible disposal

- ▶ Dispose of operating fluids in an environmentally responsible manner.

Operating fluids include the following:

- fuels
- exhaust gas aftertreatment additives, e.g. AdBlue®
- lubricants
- coolant
- brake fluid



- windscreen washer fluid
- climate control system refrigerants

Use only products recommended by Mercedes-Benz. Damage caused by the use of products that have not been approved is not covered by the Mercedes-Benz guarantee or goodwill gestures.

You can identify operating fluids approved by Mercedes-Benz by the following inscriptions on the container:

- MB-Freigabe (e.g. MB-Freigabe 229.51)
- MB-Approval (e.g. MB-Approval 229.51)

Further information on approved operating fluids:

- in the Mercedes-Benz Specifications for Operating Fluids at <http://bevo.mercedes-benz.com> (by entering the designation)
- at a qualified specialist workshop

**⚠ WARNING** Risk of fire or explosion from fuel

Fuels are highly flammable.

- ▶ Fire, naked flames, smoking and creating sparks must be avoided.
- ▶ Switch off the ignition and, if it has been in use, switch off the stationary heater before you refuel your vehicle.

**⚠ WARNING** Risk of injury from fuels

Fuels are poisonous and hazardous to your health.

- ▶ Do not swallow fuel or let it come into contact with skin, eyes or clothing.
- ▶ Do not inhale fuel vapour.
- ▶ Keep children away from fuel.
- ▶ Keep doors and windows closed during the refuelling process.

If you or other people come into contact with fuel, observe the following:

- ▶ Immediately rinse fuel off your skin with soap and water.
- ▶ If fuel comes into contact with your eyes, immediately rinse them thoroughly with clean water. Seek medical attention immediately.
- ▶ If you swallow fuel, seek medical attention immediately. Do not induce vomiting.

- ▶ Change immediately out of clothing that has come into contact with fuel.

## Fuel

### Notes on fuel grades on vehicles with diesel engines

#### General notes

Observe the notes on operating fluids (→ page 335).

**⚠ WARNING** Risk of fire from fuel mixture

If you mix diesel fuel with petrol, the flash point of the fuel mixture is lower than that of pure diesel fuel.

While the engine is running, component parts in the exhaust system may overheat without warning.

- ▶ Never refuel using petrol in diesel engines.
- ▶ Never mix petrol with diesel fuel.

**! NOTE** Damage due to incorrect fuel

Even small amounts of the wrong fuel could result in damage to the fuel system, the engine and emission control system.

- ▶ Only refuel using sulphur-free diesel fuel that conforms to the European standard EN 590 or an equivalent specification. In countries without sulphur-free diesel fuel, only fill up with low-sulphur diesel fuel with a sulphur content of less than 50 ppm.

Never refuel with:

- petrol
- marine diesel
- heating oil
- pure bio-diesel or vegetable oil
- paraffin or kerosene

If you have accidentally refuelled with the wrong fuel:

- ▶ do not switch on the ignition.
- ▶ consult a qualified specialist workshop.

The following compatibility mark for fuel applies to your vehicle:



- ① For diesel fuel with a maximum of 7 vol.% bio-diesel (fatty acid methyl ester)

In accordance with the European standard EN 16942, you will find the compatibility marks for fuel in the following places:

- on the vehicle on the instruction label in the fuel filler flap
- throughout Europe on the fuel pumps or pump nozzles suitable for your vehicle

#### XTL-compatible vehicles

Alternatively, you can also refuel with paraffinic diesel fuel (e. g. HVO=hydrogenated vegetable oil, GTL=Gas-To-Liquid) that complies with the European standard EN 15940. Paraffinic diesel fuels are collectively known as XTL.

In accordance with European standard EN 16942, the following fuel compatibility marks apply to your XTL-compatible vehicle:



- ① For diesel fuel with a maximum of 7 vol.% bio-diesel (fatty acid methyl ester)



- ② For paraffinic diesel fuel

- ⓘ **Refuel with paraffinic diesel fuels to EN 15940 only if the appropriate compatibility mark is present in your fuel filler flap.**

#### Notes on low outside temperatures

Refuel your vehicle with as much winter diesel fuel as possible at the beginning of winter.

Before switching to winter diesel fuel, the fuel tank should be as empty as possible. When first refuelling with winter diesel fuel, only refuel using a small amount, e.g. to reserve level. When refuelling the next time, the fuel tank can be filled normally again.

Further information on fuel is available:

- at a filling station
- at a qualified specialist workshop

#### Tank content and fuel reserve

The total capacity of the fuel tank may vary, depending on the vehicle equipment.

#### Tank content and fuel reserve

Diesel engine	Total capacity
OM651	Approx. 50 litres
OM651	Approx. 65 litres
OM651/OM642	Approx. 71 litres
OM651	Approx. 92 litres
OM651/OM642	Approx. 93 litres
Diesel engine	Of which reserve fuel
Models with approx. 50 litres total capacity	Approx. 12 litres
Models with approx. 65 litres total capacity	Approx. 12 litres

Diesel engine	Of which reserve fuel
Models with approx. 71 litres total capacity	Approx. 12 litres
Models with approx. 92 litres total capacity	Approx. 12 litres
Models with approx. 93 litres total capacity	Approx. 12 litres

## AdBlue®

### AdBlue® notes

Observe the notes on operating fluids (→ page 335).

AdBlue® is a water-soluble fluid for the exhaust gas aftertreatment of diesel engines.

**!** **NOTE** Damage due to additives in AdBlue® or diluting AdBlue®

AdBlue® exhaust gas aftertreatment system can be destroyed by:

- additives in AdBlue®
- diluting AdBlue®

▶ Only use AdBlue® in accordance with ISO 22241.

▶ Do not add additives.

▶ Do not dilute AdBlue®.

**!** **NOTE** Damage and malfunctions due to impurities in AdBlue®

Impurities in AdBlue® lead to:

- increased emission values
- damage to the catalytic converter
- engine damage
- malfunctions of the AdBlue® exhaust gas aftertreatment system

▶ Avoid impurities in AdBlue®.

**🔥 ENVIRONMENTAL NOTE** Contamination caused by AdBlue®

AdBlue® residues crystallise after a period of time, and contaminate the surfaces with which they come into contact.

▶ Surfaces that have come into contact with AdBlue® while refilling must be immediately rinsed with water, or AdBlue® must be removed with a damp cloth and cold water.

If AdBlue® has already crystallised, clean it with a sponge and cold water.

If you open the AdBlue® tank, small amounts of ammonia vapour may be released. Do not inhale any ammonia vapours that may be released. Fill the AdBlue® tank only in well-ventilated areas.

### AdBlue® consumption and filling capacity

#### AdBlue® consumption

Like fuel consumption, AdBlue® consumption is highly dependent upon driving style and operating conditions. AdBlue® consumption is usually within a range of 0 and 10% of the fuel consumption. If necessary, AdBlue® must be refilled in accordance with the instructions when the refill message is displayed in the instrument cluster. This may also be necessary between the scheduled maintenance.

Check the AdBlue® fill level before making journeys outside of Europe. You can refill AdBlue® at the AdBlue® filling pumps at a filling station or using commercially available refill containers.

#### Total capacity of AdBlue® tank

Vehicle	Total capacity
All models	22 litres

#### Exhaust gas aftertreatment

The exhaust gas aftertreatment system must be operated in conjunction with AdBlue® if it is to function correctly.

If you operate the vehicle without AdBlue® or with emissions-relevant malfunctions, the operating permit is invalidated. The legal consequence of this is that the vehicle may no longer be operated on public roads.

Engine management monitors the exhaust gas aftertreatment components for compliance with emissions laws and regulations. If you attempt to operate the vehicle without AdBlue®, with diluted AdBlue® or with a different reducing agent, this will be detected by the engine management system. Other emissions-relevant malfunctions, e.g. metering malfunctions or sensor errors, are also detected and logged.

The engine management system subsequently prevents the engine being restarted after issuing a warning message.

Therefore top up the AdBlue tank regularly during vehicle operation or, at the latest, after receiving the first warning message via the instrument cluster.

## Engine oil

### Notes on engine oil

Observe the notes on operating fluids (→ page 335).



**!** **NOTE** Engine damage caused by an incorrect oil filter, incorrect oil or additives

- ▶ Do not use engine oils or oil filters which do not correspond to the specifications explicitly prescribed for the service intervals.
- ▶ Do not alter the engine oil or oil filter in order to achieve longer change intervals than prescribed.
- ▶ Do not use additives.
- ▶ Have the engine oil renewed at regular intervals.

Mercedes-Benz recommends having the oil changed at a qualified specialist workshop. Only Mercedes-Benz-approved engine oils may be used in Mercedes-Benz engines.

Further information on engine oil and oil filter:

- in the Mercedes-Benz Specifications for Operating Fluids at <http://bevo.mercedes-benz.com> (by entering the designation)
- at a qualified specialist workshop

## Engine oil filling capacity

### engine oil capacities

Engine	Engine oil
OM642	Approx. 12.5 l
OM651 (rear wheel drive)	Approx. 11.5 l
OM651 (front wheel drive)	Approx. 8 l



- 1** Oil drain plug access (vehicles with under-floor panelling)

## Notes on brake fluid

Observe the notes on operating fluids (→ page 335).

**⚠** **WARNING** Risk of an accident due to vapour pockets forming in the brake system

The brake fluid constantly absorbs moisture from the air. This lowers the boiling point of the brake fluid. If the boiling point is too low, vapour pockets may form in the brake system when the brakes are applied hard.

This impairs the braking effect.

- ▶ Have the brake fluid renewed at the specified intervals.

**!** **NOTE** Damage to paint, plastic or rubber by brake fluid

There is a risk of damage to property if brake fluid comes into contact with paint, plastic or rubber.

- ▶ If paint, plastic or rubber comes into contact with brake fluid, rinse with water immediately.

Observe the notes on paintwork/matt finish paintwork care (→ page 278).

Have the brake fluid replaced regularly at a qualified specialist workshop.

Only use brake fluid approved by Mercedes-Benz in accordance with MB-Freigabe or MB-Approval 331.0.

Further information on brake fluid:

- in the Mercedes-Benz Specification for Service Products at <http://bevo.mercedes-benz.com>
- at a qualified specialist workshop

## Coolant

### Notes on coolant

Observe the notes on operating fluids (→ page 335).

#### **⚠ WARNING** Risk of fire- and injury from antifreeze

If antifreeze comes into contact with hot component parts in the engine compartment, it may ignite.

- ▶ Allow the engine to cool down before you top up the antifreeze.
- ▶ Make sure that no antifreeze spills out next to the filler opening.
- ▶ Thoroughly clean the antifreeze from component parts before starting the vehicle.

#### **!** NOTE Damage caused by incorrect coolant

- ▶ Only add coolant that has been pre-mixed with the required antifreeze protection.

Information on coolant is available at the following locations:

- in the Mercedes-Benz Specification for Operating Fluids 310.1
  - at <http://bevo.mercedes-benz.com>
  - in the Mercedes-Benz BeVo app
- at a qualified specialist workshop

#### **!** NOTE Overheating at high outside temperatures

If an inappropriate coolant is used, the engine cooling system is not sufficiently protected against overheating and corrosion at high outside temperatures.

- ▶ Always use coolant approved by Mercedes-Benz.
- ▶ Observe the instructions in the Mercedes-Benz Specifications for Operating Fluids 310.1.

#### **!** NOTE Paintwork damage due to coolant

- ▶ Do not spill coolant on painted surfaces.

Have the coolant regularly replaced at a qualified specialist workshop.

The percentage of corrosion inhibitor/antifreeze in the engine cooling system

- at least 50% (antifreeze protection up to about -37 °C)
- maximum 55% (antifreeze protection up to -45 °C)

## Windscreen washer fluid

### Notes on windscreen washer fluid

Observe the notes on operating fluids (→ page 335).

#### **⚠ WARNING** - Risk of fire and injury due to windscreen washer concentrate

Windscreen washer concentrate is highly flammable. It could ignite if it comes into contact with hot engine component parts or the exhaust system.

- ▶ Make sure that no windscreen washer concentrate spills out next to the filler opening.

#### **!** NOTE Damage to the exterior lighting due to unsuitable windscreen washer fluid

Unsuitable windscreen washer fluids may damage the plastic surface of the exterior lighting.

- ▶ Only use windscreen washer fluids which are also suitable for use on plas-

tic surfaces, e.g. MB SummerFit or MB WinterFit.

**!** **NOTE** Blocked spray nozzles caused by mixing windscreen washer fluids

- ▶ Do not mix MB SummerFit and MB WinterFit with other windscreen washer fluids.

Do not use distilled or de-ionised water as the fill level sensor may be triggered erroneously.

### Information on the windscreen washer fluid

Recommended windscreen washer fluid:

- Above freezing point: e.g. MB SummerFit
- Below freezing point: e.g. MB WinterFit

### Mixing ratio

For the correct mixing ratio, refer to the information on the anti-freeze container.

Mix the washer fluid with windscreen washer fluid all year round.

## Refrigerant

### Notes on refrigerant

Observe the notes on operating fluids (→ page 335).

- ① Your vehicle's climate control system may be filled with R-134a refrigerant. Refrigerant R-134a contains fluorinated greenhouse gas.

If your vehicle is filled with R-134a refrigerant, the following information applies:

**!** **NOTE** Damage caused by incorrect refrigerant

If the incorrect refrigerant is used, this can damage the climate control system.

- ▶ Use only R-134a refrigerant or the PAG oil approved by Mercedes-Benz.
- ▶ The approved PAG oil may not be mixed with any other PAG oil that is not approved for R-134a refrigerant.

Maintenance work, such as topping up the refrigerant or replacing components, may be carried out only by a qualified specialist workshop. All the applicable regulations relating to this and the SAE J639 standard must be adhered to.

All work on the climate control system should always be carried out at a qualified specialist workshop.

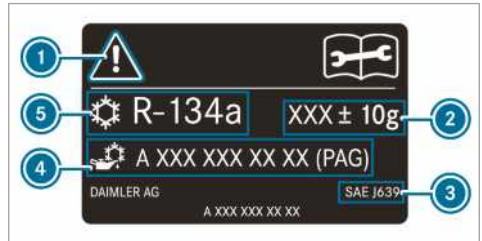

Example: refrigerant warning label

- ① Warning symbols
- ② Refrigerant capacity
- ③ Applicable standards
- ④ PAG oil part number
- ⑤ Refrigerant type

The warning symbols ① refer to:

- potential dangers
- the performance of maintenance work at a qualified specialist workshop

## Vehicle data

### Information on vehicle dimensions

The following section contains important technical data for your vehicle. Your vehicle documents contain vehicle-specific and equipment-dependent technical data such as vehicle dimensions and weights.

Current technical data can also be found online at <http://www.mercedes-benz.com>.

## Trailer hitch

### Notes on the trailer hitch

**!** **WARNING** Risk of accident due to impermissible retrofitting of a trailer tow hitch

If a trailer tow hitch has been retrofitted impermissibly and you fit a trailer tow hitch or other assembly parts, the longitudinal frame member will be weakened and may break. In this case, the trailer may come loose from the vehicle.

There is a risk of an accident.

Only retrofit a trailer tow hitch if it is permissible.

Observe the notes on trailer operation (→ page 169).

It is only permissible to retrofit a trailer hitch if a towing capacity has been entered in the vehicle registration documents.

You can obtain further information on the trailer hitch at a qualified specialist workshop or on the Internet at [https://bb-portal.mercedes-benz.com/portal/kat\\_iv.html?&L](https://bb-portal.mercedes-benz.com/portal/kat_iv.html?&L).

Mercedes-Benz recommends that you have a trailer hitch retrofitted at a Mercedes-Benz service centre.

Only use a trailer hitch which has been tested and specially approved by Mercedes-Benz for your vehicle.

The maximum permissible towing capacity for trailers without a separate braking system is 750 kg.

### Trailer loads

When towing a trailer, the maximum permissible gross vehicle weight is increased by 100 kg for vehicles with passenger vehicle approval. The maximum permissible rear axle load must be observed. The road speed of the vehicle must be limited to a maximum of 100 km/h, in accordance with Directive 92/21/EEC.

The permissible weights and loads which cannot be exceeded can also be found:

- in your vehicle documents and
- on the identification plates of the trailer hitch, trailer and vehicle

If the values differ, the lowest value applies.

### Maximum tongue weight

The tongue weight must not exceed:

- 100 kg with a trailer load of 2000 kg
- 120 kg with a trailer load of 2800 kg or 3000 kg
- 140 kg with a trailer load of 3500 kg

## Lashing points and carrier systems

### Information about the lashing points

**!** **NOTE** Risk of accident if the maximum loading capacity of the lashing points is exceeded

If you combine various lashing points to secure a load, you must always take the maximum loading capacity of the weakest lashing point into account.

During a full brake application, forces may act which can multiply the weight of the load.

▶ Always use several lashing points to distribute and spread the load. Distribute the load on the lashing points evenly.

Further information on the lashing points and tie-down eyes can be obtained in the "Transporting" chapter (→ page 264).

### Tie-down eyes

#### Max. tensile load (tie-down eyes)

Tie-down eyes	Permissible nominal tensile strength
Crewbus	350 daN
Panel van	800 daN
Platform vehicles with up to 3.5 t maximum gross weight	400 daN
Platform vehicles with more than 3.5 t maximum gross weight	800 daN

### Loading rails

#### Max. tensile load of lashing points in load compartment

Lashing point	Permissible nominal tensile strength
Loading rails on load compartment floor	500 daN
Lower loading rail on side wall	200 daN
Upper loading rail on side wall	125 daN

The values specified apply only to loads resting on the load compartment floor if:

- the load is secured to two lashing points on the rail and
- the distance to the nearest load-securing point on the same rail is approximately 1 m

### Information about roof racks

**⚠ WARNING** Risk of injury due to the maximum roof load being exceeded

When you place a load on the roof as well as all outer and inner attachments, the vehicle's centre of gravity will rise and the familiar driving characteristics as well as the steering and braking characteristics will change. When driving around bends, the vehicle will tilt more heavily and may react more sluggishly to steering movements.

If you exceed the maximum roof load, the driving characteristics, as well as the steering and braking, will be greatly impaired.

- ▶ Never exceed the maximum roof load and adjust your driving style.

**⚠ WARNING** Danger of accident due to uneven loading

If you load the vehicle unevenly, the handling characteristics as well as the steering- and braking characteristics can be heavily impaired.

- ▶ Load the vehicle evenly.
- ▶ Secure the load against sliding.

**! NOTE** Danger of accident if the maximum permitted roof load is exceeded.

If the weight of the roof luggage, including the roof rack, exceeds the maximum permitted roof load, there is the danger of an accident.

- ▶ Ensure that the weight of the roof luggage and roof rack does not exceed the maximum permitted roof load.
- ▶ The roof rack's supporting feet must be arranged at a uniform distance from each other.
- ▶ Mercedes-Benz advises you to install a stabiliser on the vehicle's front axle.

Further information about safety measures can be found in the "Transport" section (→ page 264).

### Max. roof load / roof rack supporting foot pairs

Vehicles with	Maximum roof load	Minimum number of pairs of supporting feet
Normal roof (without platform)	300 kg	6
Normal roof (with platform)	50 kg	2
High roof (without platform)	150 kg	3
Crewcab	100 kg	2

The details apply if the load is distributed evenly across the entire roof surface.

If the roof rack is shorter, reduce the load correspondingly. The maximum load per pair of roof rack supporting feet is 50 kg.

The loading guidelines and other information about load distribution and load securing can be found in the "Transport" section (→ page 264).

### Information about the ladder racks

**⚠ WARNING** Risk of accident- and injury if the load is exceeded

If you exceed the permitted load when using the rack, the rack system may disconnect from the vehicle and endanger other road users.

- ▶ Always comply with the permitted load when using the rack.

### Maximum load of ladder rack

	Maximum load
Front ladder rack	200 kg
Rear ladder rack	100 kg

The details apply if the load is distributed evenly across the entire ladder rack surface.



The loading guidelines and other information about load distribution and load securing can be found in the "Transport" section (→ page 264).

## Display messages

### Introduction



#### Information about display messages

The display messages appear on the multifunction display.

The display messages with graphic displays can be displayed in simplified format in the operating manual and may deviate from the display on the multifunction display. The multifunction display shows high-priority display messages in red. In addition, a warning tone sounds for specific display messages.

Act in accordance with the display messages and comply with the additional instructions in this operating manual.

In addition, symbols are shown for some display messages:

-  Further information
-  Hiding display messages

With left-hand Touch Control, you can select between the symbols by swiping to the left or right. Pressing  displays further information

on the multifunction display. Pressing  hides the display message.

You can hide low-priority display messages by pressing the button  or with left-hand Touch Control. The display messages are saved in the message memory.

Remove the cause of a display message as quickly as possible.

You cannot hide high-priority display messages. The multifunction display shows these display messages permanently until the cause of the display message has been eliminated.



#### Calling up saved display messages

On-board computer:





 Service  1 message







If there are no display messages, **No messages** appears on the multifunction display.



 Browse through the display messages by swiping upwards or downwards on left-hand Touch Control on the steering wheel.



 **Exiting the message memory:** press the button .

## Safety systems



Display messages	Possible causes/consequences and  Solutions
 <p>Left windowbag malfunction Consult workshop (example)</p>	<p>* The windowbag in question is malfunctioning .</p> <div style="border: 1px solid gray; padding: 5px; margin: 5px 0;"> <p> <b>WARNING</b> Risk of injury or fatal injury due to a malfunction in the window airbag</p> <p>The window airbag might be triggered unintentionally or might not be triggered at all in the event of an accident with high deceleration.</p> <ul style="list-style-type: none"> <li> Have the window airbag checked and repaired immediately at a qualified specialist workshop.</li> </ul> </div> <p> Visit a qualified specialist workshop immediately.</p>

Display messages	Possible causes/consequences and ► Solutions
 <p data-bbox="112 252 347 327">Front left malfunction Consult workshop (example)</p>	<p data-bbox="389 161 871 185">* The restraint system in question is malfunctioning .</p> <div data-bbox="406 201 1031 443" style="border: 1px solid gray; padding: 5px;"> <p data-bbox="426 212 1011 261">▲ <b>WARNING</b> Risk of injury or fatal injury due to a malfunction in the restraint system</p> <p data-bbox="423 276 1003 373">If the restraint system is malfunctioning, restraint system components may be triggered unintentionally or might not be triggered at all in the event of an accident. This may affect the seat belt tensioner or airbag, for example.</p> <p data-bbox="423 384 972 434">► Have the restraint system checked and repaired immediately at a qualified specialist workshop.</p> </div> <p data-bbox="406 459 857 483">Detection of a malfunction in the restraint system</p> <ul data-bbox="412 496 1020 603" style="list-style-type: none"> <li>• The restraint system warning lamp  does not light up when the ignition is switched on.</li> <li>• The restraint system warning lamp  lights up continuously or repeatedly during a journey.</li> </ul> <p data-bbox="406 619 885 643">► Visit a qualified specialist workshop immediately.</p>
 <p data-bbox="112 748 319 823">Restraint system malfunction Consult workshop</p>	<p data-bbox="389 657 762 681">* The restraint system is malfunctioning .</p> <div data-bbox="406 697 1031 940" style="border: 1px solid gray; padding: 5px;"> <p data-bbox="426 708 1011 758">▲ <b>WARNING</b> Risk of injury or fatal injury due to a malfunction in the restraint system</p> <p data-bbox="423 772 1003 869">If the restraint system is malfunctioning, restraint system components may be triggered unintentionally or might not be triggered at all in the event of an accident. This may affect the seat belt tensioner or airbag, for example.</p> <p data-bbox="423 880 972 930">► Have the restraint system checked and repaired immediately at a qualified specialist workshop.</p> </div> <p data-bbox="406 956 857 979">Detection of a malfunction in the restraint system</p> <ul data-bbox="412 992 1020 1099" style="list-style-type: none"> <li>• The restraint system warning lamp  does not light up when the ignition is switched on.</li> <li>• The restraint system warning lamp  lights up continuously or repeatedly during a journey.</li> </ul> <p data-bbox="406 1115 885 1139">► Visit a qualified specialist workshop immediately.</p>

Display messages	Possible causes/consequences and ► Solutions
 <p>Parking brake inoperative</p>	<p>* A malfunction has occurred in the system, the parking brake is inoperative.</p> <p><b>▲ WARNING</b> Risk of an accident due to a brake system malfunction</p> <p>If the brake system is malfunctioning, braking characteristics may be impaired.</p> <ul style="list-style-type: none"> <li>▶ Drive on carefully.</li> <li>▶ Have the brake system checked immediately at a qualified specialist workshop.</li> </ul> <p>► Only park the vehicle on a level surface and secure it against rolling away.</p> <p>► <b>Vehicles with automatic transmission:</b> shift the transmission to position <b>P</b>.</p> <p>► <b>Vehicles with manual transmission:</b> shift to first gear.</p> <p>► Have the brake system checked at a qualified specialist workshop immediately.</p>
 <p>Incline too steep See Owner's Manual</p>	<p>* The on-board voltage is low or a malfunction has occurred in the system; the holding force may not be sufficient for the incline.</p> <p><b>▲ WARNING</b> Risk of accident if the electrical parking brake has insufficient holding force</p> <p>If the electrical parking brake does not have sufficient holding force on a steep incline, the vehicle may roll away.</p> <ul style="list-style-type: none"> <li>▶ Park the vehicle on a level surface only and secure it against rolling away.</li> <li>▶ Vehicle with automatic transmissions: shift the transmission to position <b>P</b>.</li> <li>▶ Vehicles with manual transmissions: shift to first gear.</li> </ul> <p>Observe the notes on parking the vehicle (→ page 140).</p>

Display messages	Possible causes/consequences and ► Solutions
 <p>Parking brake See Owner's Manual</p>	<p>* The on-board voltage is low or a malfunction has occurred in the system; the closing force may not be sufficient for the incline.</p> <p><b>▲ WARNING</b> Risk of an accident due to a brake system malfunction</p> <p>If the brake system is malfunctioning, braking characteristics may be impaired.</p> <ul style="list-style-type: none"> <li>► Drive on carefully.</li> <li>► Have the brake system checked immediately at a qualified specialist workshop.</li> </ul> <p>► Only park the vehicle on a level surface and secure it against rolling away.</p> <p>► <b>Vehicles with automatic transmission:</b> shift the transmission to position <b>P</b>.</p> <p>► <b>Vehicles with manual transmission:</b> shift to first gear.</p> <p>► Have the brake system checked at a qualified specialist workshop immediately.</p>
<p>Check brake pads See Owner's Manual</p>	<p>* The brake pads have reached their wear limit.</p> <p><b>▲ WARNING</b> Risk of accident due to restricted braking power</p> <p>When the brake pads have reached their wear limit, the braking power may be restricted.</p> <ul style="list-style-type: none"> <li>► Drive on carefully.</li> <li>► Have the brake system checked immediately at a qualified specialist workshop.</li> </ul> <p>► Visit a qualified specialist workshop.</p>
 <p>Check brake fluid level</p>	<p>* There is not enough brake fluid in the brake fluid reservoir.</p> <p><b>▲ WARNING</b> Risk of an accident due to low brake fluid level</p> <p>If the brake fluid level is too low, the braking effect and the braking characteristics may be impaired.</p> <ul style="list-style-type: none"> <li>► Stop the vehicle as soon as possible, paying attention to road and traffic conditions. Do not continue driving.</li> <li>► Consult a qualified specialist workshop.</li> <li>► Do not top up the brake fluid.</li> </ul> <p>► Stop in a safe location immediately. Do not continue driving!</p> <p>► Consult a qualified specialist workshop.</p> <p>► Do not top up the brake fluid.</p>
<p>Caution Brakes overheated Drive carefully</p>	<p>* If the all-wheel drive has been switched on, the brake system can overheat during extreme off-road use.</p> <p>► Decelerate or stop and let the brake system cool down.</p>

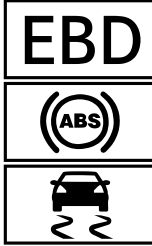



Display messages	Possible causes/consequences and ► Solutions
Active Brake Assist Functions limited See Owner's Manual	* Active Brake Assist is malfunctioning. ► Visit a qualified specialist workshop.
Active Brake Assist Functions currently limited See Owner's Manual	* Active Brake Assist is temporarily unavailable. The ambient conditions are outside the system limits (→ page 148). ► Continue driving. When the ambient conditions are within the system limits, the system is available again. ► If the display message does not go out, stop in a safe location and re-start the engine.
Radar sensors dirty See Owner's Manual	* The radar sensor system is malfunctioning. Possible causes: <ul style="list-style-type: none"> <li>• Contamination of the sensors</li> <li>• Heavy precipitation</li> <li>• Extended country drives without moving traffic, e.g. in the desert</li> </ul> Driving systems and driving safety systems may be malfunctioning or temporarily unavailable. When the causes have been eliminated, the driving systems and driving safety systems are available again. If the display message does not go out: ► Stop in a safe location. ► Clean all sensors (→ page 279). ► Re-start the engine.
SOS NOT READY	* The Mercedes-Benz emergency call system is not available. Possible causes for this include: <ul style="list-style-type: none"> <li>• the ignition is switched off</li> <li>• the Mercedes-Benz emergency call system is malfunctioning</li> </ul> ► Switch on the ignition. If an emergency call is unavailable, a message to this effect will appear on the multifunction display of the instrument cluster. ► Visit a qualified specialist workshop. ⓘ You can find more information on the regional availability of the Mercedes-Benz emergency call system at: <a href="http://www.mercedes-benz.com/connect_ecall">http://www.mercedes-benz.com/connect_ecall</a>



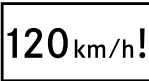

Display messages	Possible causes/consequences and ► Solutions
 <p data-bbox="109 416 333 464">inoperative See Owner's Manual</p>	<p data-bbox="389 161 767 188">* EBD, ABS and ESP® are malfunctioning.</p> <p data-bbox="400 196 1013 244">Other driving systems and driving safety systems may also be malfunctioning.</p> <div data-bbox="406 263 1031 327" style="background-color: #f0f0f0; padding: 5px;"> <p data-bbox="423 272 997 320"><b>▲ WARNING</b> Risk of skidding if EBD, ABS and ESP® are malfunctioning</p> </div> <p data-bbox="417 339 991 387">If EBD, ABS and ESP® are malfunctioning, the wheels can lock when braking and ESP® cannot carry out vehicle stabilisation.</p> <p data-bbox="417 400 980 499">The steering capability and braking characteristics are thus severely impaired. The braking distance may increase in an emergency braking situation. In addition, other driving safety systems are switched off.</p> <ul data-bbox="417 507 991 595" style="list-style-type: none"> <li>► Drive on carefully.</li> <li>► Have the brake system checked immediately at a qualified specialist workshop.</li> </ul> <ul data-bbox="406 619 890 675" style="list-style-type: none"> <li>► Continue driving carefully.</li> <li>► Visit a qualified specialist workshop immediately.</li> </ul>
 <p data-bbox="109 778 333 826">inoperative See Owner's Manual</p>	<p data-bbox="389 687 621 715">* ESP® is malfunctioning.</p> <p data-bbox="400 722 1013 770">Other driving systems and driving safety systems may also be malfunctioning.</p> <p data-bbox="400 783 991 831">The brake system continues working with the normal effect. The braking distance can increase in emergency braking situations.</p> <div data-bbox="406 850 1031 914" style="background-color: #f0f0f0; padding: 5px;"> <p data-bbox="423 860 946 887"><b>▲ WARNING</b> Risk of skidding if ESP® is malfunctioning</p> </div> <p data-bbox="417 901 1013 949">If ESP® is malfunctioning, ESP® cannot carry out vehicle stabilisation. In addition, other driving safety systems are switched off.</p> <ul data-bbox="417 957 957 1013" style="list-style-type: none"> <li>► Drive on carefully.</li> <li>► Have ESP® checked at a qualified specialist workshop.</li> </ul> <ul data-bbox="406 1037 890 1093" style="list-style-type: none"> <li>► Continue driving carefully.</li> <li>► Visit a qualified specialist workshop immediately.</li> </ul>
 <p data-bbox="109 1203 300 1251">currently unavailable See Owner's Manual</p>	<p data-bbox="389 1112 700 1139">* ESP® is temporarily unavailable.</p> <p data-bbox="400 1147 1013 1195">Other driving systems and driving safety systems may also be malfunctioning.</p> <div data-bbox="406 1214 1031 1278" style="background-color: #f0f0f0; padding: 5px;"> <p data-bbox="423 1224 946 1251"><b>▲ WARNING</b> Risk of skidding if ESP® is malfunctioning</p> </div> <p data-bbox="417 1265 1013 1313">If ESP® is malfunctioning, ESP® cannot carry out vehicle stabilisation. In addition, other driving safety systems are switched off.</p> <ul data-bbox="417 1321 957 1377" style="list-style-type: none"> <li>► Drive on carefully.</li> <li>► Have ESP® checked at a qualified specialist workshop.</li> </ul> <ul data-bbox="406 1409 1013 1513" style="list-style-type: none"> <li>► Carefully drive some gentle curves at above 30 km/h on a suitable stretch of road.</li> <li>► If the display message does not go out, visit a qualified specialist workshop immediately. Drive carefully when doing so.</li> </ul>

Display messages	Possible causes/consequences and ► Solutions
<div data-bbox="98 164 248 328"> </div> <p data-bbox="90 336 280 384">currently unavailable See Owner's Manual</p>	<p data-bbox="365 164 770 188">* ABS and ESP® are temporarily unavailable.</p> <p data-bbox="381 197 992 245">Other driving systems and driving safety systems may also be temporarily unavailable.</p> <div data-bbox="381 268 1005 603" style="border: 1px solid gray; padding: 5px;"> <p data-bbox="400 272 964 325"><b>▲ WARNING</b> Risk of skidding if ABS and ESP® are malfunctioning</p> <p data-bbox="400 341 988 394">If ABS and ESP® are malfunctioning, the wheels could lock when braking and ESP® cannot carry out vehicle stabilisation.</p> <p data-bbox="400 402 955 501">The steering capability and braking characteristics are thus severely impaired. The braking distance may increase in an emergency braking situation. In addition, other driving safety systems are switched off.</p> <ul data-bbox="400 512 938 596" style="list-style-type: none"> <li>► Drive on carefully.</li> <li>► Have ABS and ESP® checked immediately at a qualified specialist workshop.</li> </ul> </div> <ul data-bbox="381 624 994 730" style="list-style-type: none"> <li>► Carefully drive some gentle curves at above 30 km/h on a suitable stretch of road.</li> <li>► If the display message does not go out, visit a qualified specialist workshop immediately. Drive carefully when doing so.</li> </ul>
<div data-bbox="98 746 248 911"> </div> <p data-bbox="90 919 313 967">inoperative See Owner's Manual</p>	<p data-bbox="365 746 695 770">* ABS and ESP® are malfunctioning.</p> <p data-bbox="381 780 988 828">Other driving systems and driving safety systems may also be malfunctioning.</p> <p data-bbox="381 836 966 884">The brake system continues working with the normal effect. The braking distance can increase in emergency braking situations.</p> <div data-bbox="381 906 1005 1241" style="border: 1px solid gray; padding: 5px;"> <p data-bbox="400 911 964 963"><b>▲ WARNING</b> Risk of skidding if ABS and ESP® are malfunctioning</p> <p data-bbox="400 979 988 1032">If ABS and ESP® are malfunctioning, the wheels could lock when braking and ESP® cannot carry out vehicle stabilisation.</p> <p data-bbox="400 1040 955 1139">The steering capability and braking characteristics are thus severely impaired. The braking distance may increase in an emergency braking situation. In addition, other driving safety systems are switched off.</p> <ul data-bbox="400 1150 938 1235" style="list-style-type: none"> <li>► Drive on carefully.</li> <li>► Have ABS and ESP® checked immediately at a qualified specialist workshop.</li> </ul> </div> <ul data-bbox="381 1262 865 1313" style="list-style-type: none"> <li>► Continue driving carefully.</li> <li>► Visit a qualified specialist workshop immediately.</li> </ul>





## Driving systems





Display messages	Possible causes/consequences and ► Solutions
 <p>Maximum speed exceeded</p>	<ul style="list-style-type: none"> <li>* You have exceeded the maximum permitted speed (only specific countries). <ul style="list-style-type: none"> <li>► Drive more slowly.</li> </ul> </li> </ul>
<p>Speed limit (winter tyres) XXX km/h</p>	<ul style="list-style-type: none"> <li>* You have reached the maximum stored speed for winter tyres. Exceeding this speed is not possible.</li> </ul>
 <p>km/h</p>	<ul style="list-style-type: none"> <li>* The limiter cannot be activated as not all activation conditions have been met. <ul style="list-style-type: none"> <li>► Comply with the limiter's activation conditions (→ page 151).</li> </ul> </li> </ul>
<p>Speed limiter inoperative</p>	<ul style="list-style-type: none"> <li>* The limiter is malfunctioning. <ul style="list-style-type: none"> <li>► Visit a qualified specialist workshop.</li> </ul> </li> </ul>
<p>Speed limiter passive</p>	<ul style="list-style-type: none"> <li>* If you depress the accelerator pedal beyond the pressure point (kickdown), the limiter is switched to passive (→ page 151).</li> </ul>
 <p>Limiter set speed exceeded</p>	<ul style="list-style-type: none"> <li>* You have exceeded the set speed with the variable limiter by over 3 km/h.</li> </ul>
<p>Cruise control and speed limiter inoperative</p>	<ul style="list-style-type: none"> <li>* The CRUISE CONTROL and the limiter are malfunctioning. <ul style="list-style-type: none"> <li>► Visit a qualified specialist workshop.</li> </ul> </li> </ul>
<p>Cruise control inoperative</p>	<ul style="list-style-type: none"> <li>* The CRUISE CONTROL is malfunctioning. <ul style="list-style-type: none"> <li>► Visit a qualified specialist workshop.</li> </ul> </li> </ul>
 <p>Off</p>	<ul style="list-style-type: none"> <li>* The CRUISE CONTROL has been deactivated. If a warning tone also sounds, this means the CRUISE CONTROL has deactivated itself automatically (→ page 150).</li> </ul>
 <p>km/h</p>	<ul style="list-style-type: none"> <li>* The CRUISE CONTROL cannot be activated as not all activation conditions have been met. <ul style="list-style-type: none"> <li>► Observe the activation conditions of the CRUISE CONTROL (→ page 151).</li> </ul> </li> </ul>
<p>Active Distance Assist inoperative</p>	<ul style="list-style-type: none"> <li>* The Active Distance Assist DISTRONIC is malfunctioning. Other driving systems and driving safety systems may also be malfunctioning. <ul style="list-style-type: none"> <li>► Visit a qualified specialist workshop.</li> </ul> </li> </ul>
<p>Distance Pilot currently unavailable See Owner's Manual</p>	<ul style="list-style-type: none"> <li>* The Active Distance Assist DISTRONIC is temporarily unavailable. The ambient conditions are outside the system limits (→ page 153). <ul style="list-style-type: none"> <li>► Continue driving. When the ambient conditions are within the system limits, the system is available again.</li> </ul> </li> </ul>





Display messages	Possible causes/consequences and ► Solutions
  Currently unavailable Camera dirty	<p>* The camera view is reduced. Possible causes:</p> <ul style="list-style-type: none"> <li>• dirt on the windscreen in the camera's field of vision</li> <li>• heavy precipitation or fog</li> </ul> <p>Driving systems and driving safety systems may be malfunctioning or temporarily unavailable.</p> <p>When the causes have been eliminated, the driving systems and driving safety systems will be available again.</p> <p>If the display message does not disappear:</p> <ul style="list-style-type: none"> <li>► Stop in a safe location.</li> <li>► Clean the windscreen.</li> <li>► If necessary, visit a qualified specialist workshop.</li> </ul>
  Currently unavailable Radar sensors dirty	<p>* The radar sensor system is malfunctioning. Possible causes:</p> <ul style="list-style-type: none"> <li>• dirt on the sensors</li> <li>• heavy precipitation</li> <li>• extended country drives without other traffic, e.g. in the desert</li> </ul> <p>The following systems may be affected:</p> <ul style="list-style-type: none"> <li>• Active Distance Assist DISTRONIC</li> <li>• Blind Spot Assist</li> <li>• Active Brake Assist</li> </ul> <p>Driving systems and driving safety systems may be malfunctioning or temporarily unavailable.</p> <p>When the causes have been eliminated, the driving systems and driving safety systems will be available again.</p> <p>If the display message does not disappear:</p> <ul style="list-style-type: none"> <li>► Stop in a safe location.</li> <li>► Clean all sensors (→ page 279).</li> <li>► Re-start the engine.</li> <li>► If necessary, visit a qualified specialist workshop.</li> </ul>
Distance Pilot available again	<p>* The Active Distance Assist DISTRONIC is operational again and can be activated (→ page 154).</p>
 Off	<p>* The HOLD function has been deactivated because the vehicle is slipping or an activation condition has not been met.</p> <ul style="list-style-type: none"> <li>► Re-activate the HOLD function later on or check the HOLD function's activation conditions (→ page 155).</li> </ul>
Traffic Sign Assist inoperative	<p>* The Traffic Sign Assist is malfunctioning.</p> <ul style="list-style-type: none"> <li>► Visit a qualified specialist workshop.</li> </ul>

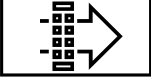

Display messages	Possible causes/consequences and ► Solutions
<p>Traffic Sign Assist Camera view restricted See Owner's Manual</p>	<p>* The camera view is reduced. Possible causes:</p> <ul style="list-style-type: none"> <li>• Dirt on the windscreen in the camera's field of vision</li> <li>• Heavy precipitation or fog</li> </ul> <p>Driving systems and driving safety systems may be malfunctioning or temporarily unavailable.</p> <p>When the causes have been eliminated, the driving systems and driving safety systems are available again.</p> <p>If the display message does not go out:</p> <ul style="list-style-type: none"> <li>► Stop in a safe location.</li> <li>► Clean the windscreen.</li> </ul>
<p>Traffic Sign Assist currently unavailable See Owner's Manual</p>	<p>* Traffic Sign Assist is temporarily unavailable (→ page 162).</p> <ul style="list-style-type: none"> <li>► Continue driving. When the causes have been eliminated, the system will be available again.</li> </ul>
<p>Blind Spot Assist inoperative</p>	<p>* Blind Spot Assist is malfunctioning (→ page 164).</p> <ul style="list-style-type: none"> <li>► Visit a qualified specialist workshop.</li> </ul>
<p>Totwinkel-Assistent Anhänger nicht überwacht</p>	<p>* When you establish an electrical connection with the trailer, Blind Spot Assist will remain available but the area beside the trailer will not be monitored. The function of Blind Spot Assist may be restricted as a result (→ page 164).</p> <ul style="list-style-type: none"> <li>► Press the left-hand Touch Control and acknowledge the display message.</li> </ul>
<p>Blind Spot Assist currently unavailable See Owner's Manual</p>	<p>* Blind Spot Assist is temporarily unavailable (→ page 164). The system limits have been reached (→ page 164).</p> <ul style="list-style-type: none"> <li>► Continue driving. When the causes have been eliminated, the system will be available again.</li> </ul> <p>or</p> <ul style="list-style-type: none"> <li>► If the display message does not go out, stop in a safe location and re-start the engine.</li> <li>► If necessary, clean the rear bumper. If the bumper is very dirty, the sensors in the bumper may malfunction.</li> </ul>
<p>Active Lane Keeping Assist Camera view restricted See Owner's Manual</p>	<p>* The camera view is reduced (→ page 166). Possible causes:</p> <ul style="list-style-type: none"> <li>• dirt on the windscreen in the camera's field of vision</li> <li>• heavy precipitation or fog</li> </ul> <p>Driving systems and driving safety systems may be malfunctioning or temporarily unavailable.</p> <p>When the causes have been eliminated, the driving systems and driving safety systems will be available again.</p> <p>If the display message does not disappear:</p> <ul style="list-style-type: none"> <li>► Stop in a safe location.</li> <li>► Clean the windscreen.</li> </ul>

Display messages	Possible causes/consequences and ► Solutions
Active Lane Keeping Assist inoperative	* Active Lane Keeping Assist is malfunctioning (→ page 166). ► Visit a qualified specialist workshop.
Active Lane Keeping Assist currently unavailable See Owner's Manual	* Active Lane Keeping Assist is temporarily unavailable (→ page 166). The ambient conditions are outside the system limits (→ page 166). ► Continue driving. When the ambient conditions are within the system limits, the system will be available again.  If the display message does not disappear: ► Stop in a safe location. ► Clean the windscreen.
 Attention Assist inoperative	* The ATTENTION ASSIST is malfunctioning. ► Visit a qualified specialist workshop.
 Attention Assist: Pause!	* The ATTENTION ASSIST has detected fatigue or increasing inattentiveness on the driver's part (→ page 161). ► If necessary, take a break.

## Engine

Display messages	Possible causes/consequences and ► Solutions
 Coolant temperature high	* The fan motor is faulty. ► Without a high engine load, continue to the nearest qualified specialist workshop. Ensure that the coolant temperature display remains below 120 °C.
 Reserve fuel level	* The fuel supplies have reached the reserve level. ► Refuel.
 Replace air filter	* <b>Vehicles with a diesel engine:</b> The engine air filter is clogged and must be replaced. ► Visit a qualified specialist workshop.
 Clean the fuel filter	* The water that has accumulated in the water separator has reached the maximum level. ► Drain the water separator (→ page 276).

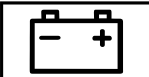
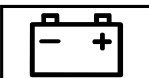

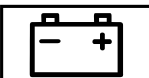



Display messages	Possible causes/consequences and ► Solutions
 <p>Engine oil level cannot be measured</p>	<p>* The electrical connection to the oil level sensor has been interrupted or the oil level sensor is faulty. The engine oil level has fallen to the minimum level.</p> <p>► Visit a qualified specialist workshop.</p>
 <p>Engine oil pressure Stop Switch off engine</p>	<p>* Display message for certain engines only: The engine oil pressure is too low.</p> <div style="border: 1px solid black; padding: 5px; margin-bottom: 5px;"> <p><b>!</b> <b>NOTE</b> Engine damage caused by driving with insufficient engine oil pressure</p> </div> <p>► Avoid driving with insufficient engine oil pressure.</p> <p>► Stop in a safe location immediately. Do not continue driving!</p> <p>► Consult a qualified specialist workshop.</p>
 <p>Add 1 litre engine oil when next refuelling</p>	<p>* Display message for certain engines only: The engine oil level has fallen to the minimum level.</p> <div style="border: 1px solid black; padding: 5px; margin-bottom: 5px;"> <p><b>!</b> <b>NOTE</b> Engine damage caused by driving with insufficient engine oil</p> </div> <p>► Avoid long journeys with insufficient engine oil.</p> <p>► Check the engine oil level at the next fuel stop. Top up engine oil (→ page 273). Information about the engine oil (→ page 339).</p>
 <p>Engine oil level Reduce oil level</p>	<p>* Display message for certain engines only: The engine oil level is too high.</p> <div style="border: 1px solid black; padding: 5px; margin-bottom: 5px;"> <p><b>!</b> <b>NOTE</b> Engine damage caused by driving with excess engine oil</p> </div> <p>► Avoid long journeys with excess engine oil.</p> <p>► Visit a qualified specialist workshop immediately and have the engine oil suctioned off.</p>
 <p>Engine oil level Stop vehi- cle Switch engine off</p>	<p>* Display message for certain engines only: The engine oil level is too low.</p> <div style="border: 1px solid black; padding: 5px; margin-bottom: 5px;"> <p><b>!</b> <b>NOTE</b> Engine damage caused by driving with insufficient engine oil</p> </div> <p>► Avoid long journeys with insufficient engine oil.</p> <p>► Stop in a safe location immediately. Do not continue driving!</p> <p>► Switch off the engine.</p> <p>► Check the engine oil level.</p> <p>Top up the engine oil (→ page 273). Information about the engine oil (→ page 339).</p>

Display messages	Possible causes/consequences and ► Solutions
 <p>Check engine oil level when next refuelling</p>	<p>* The engine oil level has fallen to the minimum level.</p> <div style="border: 1px solid black; padding: 5px; margin-bottom: 5px;"> <p><b>!</b> <b>NOTE</b> Engine damage caused by driving with insufficient engine oil</p> <p>► Avoid long journeys with insufficient engine oil.</p> </div> <p>► Check the engine oil level at the next fuel stop.</p> <p>Top up engine oil (→ page 273). Information about the engine oil (→ page 339).</p>
 <p>Stop vehicle Leave engine running</p>	<p>* The battery's charge level is too low.</p> <p>► Stop in a safe location immediately. Do not continue driving!</p> <p>► Let the engine run.</p> <p>► Do not continue driving until the display message goes out.</p>
 <p>Stop vehicle See Owner's Manual</p>	<p>* The battery is no longer being charged and has reached an excessively low battery charge level.</p> <div style="border: 1px solid black; padding: 5px; margin-bottom: 5px;"> <p><b>!</b> <b>NOTE</b> Possible engine damage if you continue driving</p> <p>► Do not continue driving under any circumstances.</p> <p>► Consult a qualified specialist workshop.</p> </div> <p>► Stop in a safe location immediately. Do not continue driving!</p> <p>► Switch off the engine.</p> <p>► Consult a qualified specialist workshop.</p>
 <p>Start engine See Owner's Manual</p>	<p>* The engine is off and the battery charge level is too low.</p> <p>► Switch off electrical consumers that are not required.</p> <p>► Let the engine run for a few minutes or drive an extended distance. The battery is charged.</p>
 <p>See Owner's Manual</p>	<p>* The battery is no longer being charged.</p> <div style="border: 1px solid black; padding: 5px; margin-bottom: 5px;"> <p><b>!</b> <b>NOTE</b> Possible engine damage if you continue driving</p> <p>► Do not continue driving under any circumstances.</p> <p>► Consult a qualified specialist workshop.</p> </div> <p>► Stop in a safe location immediately and switch off the engine.</p> <p>► Consult a qualified specialist workshop.</p>





Display messages	Possible causes/consequences and ► Solutions
 <p data-bbox="112 252 300 300">Coolant Stop vehicle Switch engine off</p>	<p data-bbox="389 162 607 181">* The coolant is too hot.</p> <ul style="list-style-type: none"> <li data-bbox="405 194 1001 217">► Stop in a safe location immediately and switch off the engine.</li> </ul> <div data-bbox="405 242 1028 466" style="border: 1px solid #ccc; padding: 5px;"> <p data-bbox="427 252 954 274"><b>▲ WARNING</b> Danger of burns when opening the bonnet</p> <p data-bbox="423 290 1008 363">If you open the engine bonnet when the engine has overheated or during a fire in the engine compartment, you could come into contact with hot gases or other escaping operating fluids.</p> <ul style="list-style-type: none"> <li data-bbox="427 373 987 395">► Before opening the bonnet, allow the engine to cool down.</li> <li data-bbox="427 405 983 453">► In the event of a fire in the engine compartment, keep the engine bonnet closed and call the fire service.</li> </ul> </div> <div data-bbox="405 481 1028 737" style="border: 1px solid #ccc; padding: 5px;"> <p data-bbox="427 491 871 513"><b>▲ WARNING</b> Risk of scalding from hot coolant</p> <p data-bbox="423 529 1014 603">The engine cooling system is pressurised, particularly when the engine is warm. If you open the cap, you could be scalded by hot coolant spraying out.</p> <ul style="list-style-type: none"> <li data-bbox="427 612 909 635">► Let the engine cool down before opening the cap.</li> <li data-bbox="427 644 976 692">► When opening the cap, wear protective gloves and safety glasses.</li> <li data-bbox="427 702 826 724">► Open the cap slowly to release pressure.</li> </ul> </div> <ul style="list-style-type: none"> <li data-bbox="405 753 792 775">► Wait until the engine has cooled down.</li> <li data-bbox="405 785 1014 833">► Ensure that the air supply to the engine radiator is not obstructed.</li> <li data-bbox="405 842 1014 916">► Without subjecting the engine to excessive strain, continue to the nearest qualified specialist workshop. Ensure that the coolant temperature display remains below 120 °C.</li> </ul>
<p data-bbox="112 938 342 986">Top up coolant See Owner's Manual</p>	<p data-bbox="389 933 658 956">* The coolant level is too low.</p> <div data-bbox="405 976 1028 1232" style="border: 1px solid #ccc; padding: 5px;"> <p data-bbox="427 986 871 1008"><b>▲ WARNING</b> Risk of scalding from hot coolant</p> <p data-bbox="423 1024 1014 1098">The engine cooling system is pressurised, particularly when the engine is warm. If you open the cap, you could be scalded by hot coolant spraying out.</p> <ul style="list-style-type: none"> <li data-bbox="427 1107 909 1129">► Let the engine cool down before opening the cap.</li> <li data-bbox="427 1139 976 1187">► When opening the cap, wear protective gloves and safety glasses.</li> <li data-bbox="427 1197 826 1219">► Open the cap slowly to release pressure.</li> </ul> </div> <div data-bbox="405 1248 1028 1327" style="border: 1px solid #ccc; padding: 5px;"> <p data-bbox="427 1257 909 1279"><b>! NOTE</b> Engine damage due to insufficient coolant</p> <ul style="list-style-type: none"> <li data-bbox="427 1295 864 1318">► Avoid long journeys with insufficient coolant.</li> </ul> </div> <ul style="list-style-type: none"> <li data-bbox="405 1343 707 1366">► Top up coolant (→ page 274).</li> </ul>

Display messages	Possible causes/consequences and ► Solutions
Regeneration not possible	<ul style="list-style-type: none"> <li>* Not all conditions have been met for regeneration of the diesel particulate filter (→ page 121).                             <ul style="list-style-type: none"> <li>► Continue driving as normal until all conditions have been met for regeneration of the diesel particle filter.</li> </ul> </li> <li>The load condition of the diesel particulate filter is over 50% and the message still appears on the instrument cluster.                             <ul style="list-style-type: none"> <li>► Visit a qualified specialist workshop.</li> </ul> </li> </ul>



### AdBlue® (vehicles with passenger car registration)







Display messages	Possible causes/consequences and ► Solutions
 <p>Top up AdBlue See Owner's Manual</p>	<ul style="list-style-type: none"> <li>* The AdBlue® supplies have fallen below the reserve mark.                             <ul style="list-style-type: none"> <li>► Top up at least 8 l of AdBlue® immediately (→ page 136).</li> </ul> </li> </ul>
 <p>Top up AdBlue Perf. reduced in XXXmiles See Owner's Manual</p>	<ul style="list-style-type: none"> <li>* The low AdBlue® level will lead to a speed restriction once the remaining distance displayed has been covered.                             <ul style="list-style-type: none"> <li>► Top up at least 8 l of AdBlue® immediately (→ page 136).</li> </ul> </li> </ul>
 <p>Top up AdBlue Perf. reduced: 12 mph No start in XXX miles</p>	<ul style="list-style-type: none"> <li>* The low AdBlue® level will restrict the speed to a maximum of 20 km/h.                             <p>After the remaining distance displayed has been covered, it will no longer be possible to start the engine.</p> <ul style="list-style-type: none"> <li>► Top up at least 8 l of AdBlue® immediately (→ page 136).</li> </ul> </li> </ul>
 <p>Top up AdBlue No start in XXX miles</p>	<ul style="list-style-type: none"> <li>* The AdBlue® level is only sufficient for the distance displayed.                             <ul style="list-style-type: none"> <li>► Top up at least 8 l of AdBlue® immediately (→ page 136).</li> <li>ⓘ The message disappears after roughly one minute of travelling at over 15 km/h.</li> </ul> </li> </ul>
 <p>Refill AdBlue Engine start not possible</p>	<ul style="list-style-type: none"> <li>* The AdBlue® supplies are used up. You can no longer start the engine.                             <ul style="list-style-type: none"> <li>► Top up at least 8 l of AdBlue® immediately (→ page 136).</li> <li>► Switch on the ignition.                                     <p>You can re-start the engine after around one minute.</p> </li> </ul> </li> </ul>
 <p>System fault No start in XXX miles</p>	<ul style="list-style-type: none"> <li>* The AdBlue® system is malfunctioning. After the remaining distance displayed has been covered, it will no longer be possible to start the engine.                             <ul style="list-style-type: none"> <li>► Visit a qualified specialist workshop immediately.</li> </ul> </li> </ul>



Display messages	Possible causes/consequences and ► Solutions
 <p>AdBlue system fault See Owner's Manual</p>	<p>* The AdBlue® system is malfunctioning.</p> <p>► Visit a qualified specialist workshop immediately.</p>
 <p>Cannot measure fluid level</p>	<p>* If an AdBlue® system malfunction occurs, no tank fill level is displayed on the service menu. The AdBlue® system malfunction is indicated by the relevant warning messages.</p> <p>► Visit a qualified specialist workshop.</p>
 <p>AdBlue system fault Perf. reduced in XXX miles See Owner's Manual</p>	<p>* The AdBlue® system is malfunctioning. The system malfunction will lead to a speed restriction once the remaining distance displayed has been covered.</p> <p>► Visit a qualified specialist workshop immediately.</p>
 <p>AdBlue system fault Perf. reduced: 12 mph No start in XXX miles</p>	<p>* The AdBlue® system is malfunctioning. The system malfunction will restrict the speed to a maximum of 20 km/h. After the distance displayed has been covered, it will no longer be possible to start the engine.</p> <p>► Visit a qualified specialist workshop immediately.</p>
 <p>AdBlue system fault Engine start not possible</p>	<p>* The AdBlue® system is malfunctioning. You can no longer start the engine.</p> <p>► Inform a qualified specialist workshop immediately.</p>



**AdBlue® (vehicles with lorry registration)**

Display messages	Possible causes/consequences and ► Solutions
 <p>Top up AdBlue See Owner's Manual</p>	<p>* The AdBlue® supplies have fallen below the reserve mark.</p> <p>► Top up at least 8 l of AdBlue® immediately (→ page 136).</p>
 <p>Top up AdBlue Performance reduced</p>	<p>* The AdBlue® supplies have fallen below the reserve mark. The power is restricted to 75% of the engine torque.</p> <p>► Top up at least 8 l of AdBlue® immediately (→ page 136).</p>

Display messages	Possible causes/consequences and ► Solutions
 <p>Top up AdBlue Performance reduced after eng. restart: 12 mph</p>	<p>* The next time the engine is started, the low AdBlue® level will restrict the speed to a maximum of 20 km/h.</p> <p>► Top up at least 8 l of AdBlue® immediately (→ page 136).</p>
 <p>Top up AdBlue Power reduced: 12 mph</p>	<p>* The level of AdBlue® consumption means that the speed will be restricted to a maximum of 20 km/h.</p> <p>► Top up at least 8 l of AdBlue® immediately (→ page 136).</p> <p>► Switch on the ignition.</p>
 <p>AdBlue system fault See Owner's Manual</p>	<p>* The AdBlue® system is malfunctioning.</p> <p>► Visit a qualified specialist workshop immediately.</p>
 <p>AdBlue system fault Performance reduced</p>	<p>* The AdBlue® system is malfunctioning. The power is restricted to 75 % of the engine torque.</p> <p>► Visit a qualified specialist workshop immediately.</p>
 <p>AdBlue system fault Performance reduced after eng. restart: XXX mph</p>	<p>* The AdBlue® system is malfunctioning. The next time the engine is started, the system malfunction will restrict the speed to a maximum of 20 km/h.</p> <p>► Visit a qualified specialist workshop immediately.</p>
 <p>AdBlue system fault Performance reduced: 12 mph</p>	<p>* The AdBlue® system is malfunctioning. The system malfunction will restrict the speed to a maximum of 20 km/h.</p> <p>► Inform a qualified specialist workshop immediately.</p>



## Tyres



Display messages	Possible causes/consequences and ► Solutions
<p>Tyre pressure monitor inoperative No wheel sensors</p>	<p>* The installed wheels do not have suitable tyre pressure sensors. The tyre pressure monitor has been switched off.</p> <p>► Install wheels with suitable tyre pressure sensors.</p>
 <p>Wheel sensor(s) missing</p>	<p>* The tyre pressure sensor signal is missing from one or more tyre(s). No pressure value is displayed for the tyre in question.</p> <p>► Have the faulty tyre pressure sensor replaced in a qualified specialist workshop.</p>

Display messages	Possible causes/consequences and ► Solutions
<p>Tyre pressure monitor currently unavailable</p>	<p>* There is interference from a powerful source of radio waves. As a result, no signals from the tyre pressure sensors are received. The tyre pressure monitor is temporarily unavailable.</p> <p>► Continue driving. As soon as the cause has been eliminated, the tyre pressure monitor automatically switches on.</p>
 <p>Warning tyre defect</p>	<p>* The pressure in one or more tyres suddenly falls. The wheel position is shown.</p> <div style="border: 1px solid black; padding: 5px; margin: 10px 0;"> <p><b>▲ WARNING</b> Risk of an accident from driving with a flat tyre</p> <p>Flat tyres are dangerous in the following ways:</p> <ul style="list-style-type: none"> <li>• The tyres can overheat and cause a fire.</li> <li>• - The driving characteristics, steering and braking may be greatly impaired.</li> </ul> <p>You could then lose control of the vehicle.</p> <p>► Do not drive with a flat tyre. ► Observe the notes on flat tyres.</p> </div> <p>Information about flat tyres (→ page 284).</p> <p>► Stop the vehicle in a safe location. ► Check the tyres.</p>
 <p>Check tyre(s)</p>	<p>* The pressure in one or more tyres has fallen significantly. The wheel position is shown.</p> <div style="border: 1px solid black; padding: 5px; margin: 10px 0;"> <p><b>▲ WARNING</b> Risk of an accident due to insufficient tyre pressure</p> <p>Tyres with insufficient tyre pressure pose the following risks:</p> <ul style="list-style-type: none"> <li>• The tyres may burst, especially as the load and vehicle speed increase.</li> <li>• The tyres may wear excessively and/or unevenly, which may greatly impair tyre traction.</li> <li>• - The driving characteristics, steering and braking may be greatly impaired.</li> </ul> <p>You could then lose control of the vehicle.</p> <p>► Observe the recommended tyre pressures. ► Adjust the tyre pressure if necessary.</p> </div> <p>► Stop the vehicle in a safe location. ► Check the tyre pressure (→ page 303) and the tyres.</p>
 <p>Correct tyre pressure</p>	<p>* The pressure in at least one tyre is too low or the pressures of the individual tyres deviate too much from each other.</p> <p>► Check the tyre pressure, and add air if necessary. ► When the tyre pressure has been set correctly, re-start the tyre pressure monitor (→ page 315).</p>





Display messages	Possible causes/consequences and ► Solutions
Tyre pressure monitor inoperative	* The tyre pressure monitor is malfunctioning. ► Visit a qualified specialist workshop.
Tyre pressure Check tyre(s)	* The tyre pressure loss warning has detected a major pressure loss. <div style="border: 1px solid black; padding: 5px; margin: 10px 0;"> <p><b>▲ WARNING</b> Risk of an accident due to insufficient tyre pressure</p> <p>Tyres with insufficient tyre pressure pose the following risks:</p> <ul style="list-style-type: none"> <li>• The tyres may burst, especially as the load and vehicle speed increase.</li> <li>• The tyres may wear excessively and/or unevenly, which may greatly impair tyre traction.</li> <li>• - The driving characteristics, steering and braking may be greatly impaired.</li> </ul> <p>You could then lose control of the vehicle.</p> <ul style="list-style-type: none"> <li>► Observe the recommended tyre pressures.</li> <li>► Adjust the tyre pressure if necessary.</li> </ul> </div> <ul style="list-style-type: none"> <li>► Stop the vehicle in a safe location.</li> <li>► Check the tyre pressure (→ page 303) and the tyres.</li> <li>► When the tyre pressure has been set correctly, re-start the tyre pressure loss warning .</li> </ul>





## Key



Display messages	Possible causes/consequences and ► Solutions
 <p>Place the key in the marked space See Owner's Manual</p>	* Key detection is malfunctioning. <ul style="list-style-type: none"> <li>► Change the key's position in the vehicle.</li> <li>► Start the vehicle with the key in the slot(→ page 111).</li> </ul>
 <p>Key not detected (red display message)</p>	* The key is not detected and may no longer be in the vehicle. The key is no longer in the vehicle and you switch the engine off: <ul style="list-style-type: none"> <li>• You can no longer start the engine.</li> <li>• You cannot lock the vehicle centrally.</li> </ul> <ul style="list-style-type: none"> <li>► Ensure that the key is in the vehicle.</li> </ul> If key detection malfunctions due to a strong radio signal source: <ul style="list-style-type: none"> <li>► Stop in a safe location immediately.</li> <li>► Place the key in the slot for starting with the key (→ page 111).</li> </ul>



Display messages	Possible causes/consequences and ► Solutions
 Key not detected (white display message)	<ul style="list-style-type: none"> <li>* The key is currently not detected.                             <ul style="list-style-type: none"> <li>► Change the key's position in the vehicle.</li> <li>► If the key still is not detected, start the engine with the key in the slot(→ page 111).</li> </ul> </li> </ul>
 Change key batteries	<ul style="list-style-type: none"> <li>* The key's battery is flat.                             <ul style="list-style-type: none"> <li>► Change the battery (→ page 42).</li> </ul> </li> </ul>
 Replace key	<ul style="list-style-type: none"> <li>* The key must be replaced.                             <ul style="list-style-type: none"> <li>► Visit a qualified specialist workshop.</li> </ul> </li> </ul>

Vehicle

Display messages	Possible causes/consequences and ► Solutions
 Top up washer fluid	<ul style="list-style-type: none"> <li>* Washer fluid level in washer reservoir has fallen below the minimum.                             <ul style="list-style-type: none"> <li>► Top up washer fluid (→ page 275).</li> </ul> </li> </ul>
	<ul style="list-style-type: none"> <li>* At least one door is open.                             <ul style="list-style-type: none"> <li>► Close all the doors.</li> </ul> </li> </ul>
	<ul style="list-style-type: none"> <li>* The bonnet is open.                             <p>Stop the vehicle in a safe location immediately.</p> <div style="border: 1px solid black; padding: 5px; margin: 5px 0;"> <p><b>▲ WARNING</b> Risk of accident due to driving with the engine bonnet unlocked</p> <p>An unlocked engine bonnet may open up when the vehicle is in motion and block your view.</p> <ul style="list-style-type: none"> <li>► Never unlock the engine bonnet when driving.</li> <li>► Before every trip, ensure that the engine bonnet is locked.</li> </ul> </div> <ul style="list-style-type: none"> <li>► Stop the vehicle in a safe location immediately.</li> <li>► Close the bonnet.</li> </ul> </li> </ul>
 inoperative See Owner's Manual	<ul style="list-style-type: none"> <li>* Stationary heating is temporarily malfunctioning.                             <ul style="list-style-type: none"> <li>► When the vehicle is at a standstill in a horizontal position and the engine has cooled down: try to switch on the stationary heating four times, leaving a gap of several minutes between each attempt.</li> <li>► If the stationary heating does not switch on: visit a qualified specialist workshop.</li> </ul> </li> </ul>







Display messages	Possible causes/consequences and ► Solutions
 <p data-bbox="87 252 304 300">inoperative Refuel vehicle</p>	<p data-bbox="364 161 1003 209">* There is too little fuel in the fuel tank. The stationary heating cannot be switched on.</p> <ul style="list-style-type: none"> <li data-bbox="381 220 583 244">► Refuel the vehicle.</li> </ul>
 <p data-bbox="87 403 304 427">inoperative Battery low</p>	<p data-bbox="364 316 748 368">* The on-board voltage is too low. The stationary heating has switched off.</p> <ul style="list-style-type: none"> <li data-bbox="381 379 958 427">► Drive an extended distance until the battery has been sufficiently charged again.</li> </ul>
 <p data-bbox="87 531 314 603">Before starting the engine, turn the steering wheel</p>	<p data-bbox="364 443 1000 491">* <b>Vehicles with manual transmission:</b> the electrical steering wheel lock was unable to unlock the steering.</p> <ul style="list-style-type: none"> <li data-bbox="381 502 622 526">► Switch off the ignition.</li> <li data-bbox="381 537 1005 585">► To release the tension, turn the steering wheel slightly to the left and right.</li> <li data-bbox="381 596 675 620">► Switch on the ignition again.</li> </ul>
 <p data-bbox="87 715 281 762">Steering malfunction See Owner's Manual</p>	<p data-bbox="364 627 996 699">* <b>Vehicles with manual transmission:</b> the electric steering lock is malfunctioning. The steering may be locked by the electric steering lock.</p> <div data-bbox="381 722 1003 938" style="border: 1px solid gray; padding: 5px;"> <p data-bbox="400 730 988 754"><b>⚠ WARNING</b> Risk of accident if steering capability is impaired</p> <p data-bbox="400 770 983 818">If the steering does not function as intended, the vehicle's operating safety is jeopardised.</p> <ul style="list-style-type: none"> <li data-bbox="400 826 972 898">► Pull over and stop the vehicle safely as soon as possible, paying attention to road and traffic conditions. Do not continue driving under any circumstances.</li> <li data-bbox="400 914 798 938">► Consult a qualified specialist workshop.</li> </ul> </div> <ul style="list-style-type: none"> <li data-bbox="381 962 966 986">► Stop in a safe location immediately. Do not continue driving!</li> <li data-bbox="381 994 776 1018">► Consult a qualified specialist workshop.</li> </ul>
 <p data-bbox="87 1114 314 1185">Steering malfunction Increased physical effort See Owner's Manual</p>	<p data-bbox="364 1026 826 1050">* The steering power assistance is malfunctioning.</p> <div data-bbox="381 1074 1003 1289" style="border: 1px solid gray; padding: 5px;"> <p data-bbox="400 1082 988 1129"><b>⚠ WARNING</b> Risk of an accident due to altered steering characteristics</p> <p data-bbox="400 1145 949 1193">If the power assistance of the steering fails partially or completely, you will need to use more force to steer.</p> <ul style="list-style-type: none"> <li data-bbox="400 1201 843 1225">► If safe steering is possible, drive on carefully.</li> <li data-bbox="400 1233 938 1281">► Visit or consult a qualified specialist workshop immediately.</li> </ul> </div> <ul style="list-style-type: none"> <li data-bbox="381 1313 826 1337">► If safe steering is possible, drive on carefully.</li> <li data-bbox="381 1345 960 1369">► Visit or consult a qualified specialist workshop immediately.</li> </ul>

Display messages	Possible causes/consequences and ► Solutions
 <p>Steering malfunction Stop immediately See Owner's Manual</p>	<p>* The steering is malfunctioning. Steerability is heavily impaired.</p> <div style="border: 1px solid black; padding: 5px; margin: 5px 0;"> <p><b>▲ WARNING</b> Risk of accident if steering capability is impaired</p> <p>If the steering does not function as intended, the vehicle's operating safety is jeopardised.</p> <ul style="list-style-type: none"> <li>► Pull over and stop the vehicle safely as soon as possible, paying attention to road and traffic conditions. Do not continue driving under any circumstances.</li> <li>► Consult a qualified specialist workshop.</li> </ul> </div> <ul style="list-style-type: none"> <li>► Stop in a safe location immediately. Do not continue driving!</li> <li>► Consult a qualified specialist workshop.</li> </ul>
<p>To start engine, shift to P or N</p>	<p>* You have tried to start the engine in transmission position <b>D</b> or <b>R</b>.</p> <ul style="list-style-type: none"> <li>► Shift the transmission to position <b>P</b> or <b>N</b>.</li> </ul>
<p>To select R, depress brake</p>	<p>* You have tried, from position <b>D</b> or <b>N</b> to shift to transmission position <b>R</b>.</p> <ul style="list-style-type: none"> <li>► Press the brake pedal.</li> <li>► Shift the transmission to position <b>R</b>.</li> </ul>
<p>Air conditioning malfunction See Owner's Manual</p>	<p>* The climate control system is functional, subject to temporary restrictions. The air quantity and fresh air supply are controlled automatically.</p> <ul style="list-style-type: none"> <li>► Have the climate control system checked in a qualified specialist workshop.</li> </ul>
<p>Backup battery malfunction</p>	<p>* The backup battery for the transmission is not being charged.</p> <ul style="list-style-type: none"> <li>► Visit a qualified specialist workshop.</li> <li>► Until then, always shift the transmission to position <b>P</b> manually before switching the engine off.</li> <li>► Before leaving the vehicle, apply the parking brake.</li> </ul>
<p>Reversing not possible: Consult workshop</p>	<p>* The transmission is malfunctioning. It is no longer possible to shift to reverse gear.</p> <ul style="list-style-type: none"> <li>► Visit a qualified specialist workshop.</li> </ul>
<p>Transmission malfunction Stop</p>	<p>* The transmission is malfunctioning. The transmission automatically shifts to position <b>N</b>.</p> <ul style="list-style-type: none"> <li>► Stop in a safe location immediately.</li> <li>► Shift the transmission to position <b>P</b>.</li> <li>► Consult a qualified specialist workshop.</li> </ul>
 <p>Vehicle is operational Switch off the ignition before exiting</p>	<p>* You are about to exit the vehicle while it is ready to start.</p> <ul style="list-style-type: none"> <li>► When you exit the vehicle, switch off the ignition and take the key with you.</li> <li>► If you do not exit the vehicle, switch off the electrical consumers, e.g. the seat heating. Otherwise, the 12-Volt-battery may discharge and the vehicle can only be started using a booster battery (jump start).</li> </ul>

Display messages	Possible causes/consequences and ► Solutions
Without changing gear, consult workshop	<ul style="list-style-type: none"> <li>* The transmission is malfunctioning. The transmission position can no longer be changed.               <ul style="list-style-type: none"> <li>► If the transmission is in position <b>D</b>, visit a qualified specialist workshop, without changing the transmission position.</li> <li>► For all other transmission positions, park the vehicle in a safe location.</li> <li>► Consult a qualified specialist workshop.</li> </ul> </li> </ul>
Only select Park (P) when vehicle is stationary	<ul style="list-style-type: none"> <li>* The transmission can only be brought into position <b>P</b> if the vehicle is at a standstill.</li> </ul>
N permanently active Risk of vehicle rolling	<ul style="list-style-type: none"> <li>* While the vehicle is rolling or driving, the transmission was shifted to position <b>N</b>.               <ul style="list-style-type: none"> <li>► To stop, press the brake pedal and, when the vehicle is at a standstill, shift the transmission to position <b>P</b>.</li> <li>► To continue driving, shift the transmission to position <b>D</b> or <b>R</b>.</li> </ul> </li> </ul>
Risk of vehicle rolling Driver's door open and transmission not in P	<ul style="list-style-type: none"> <li>* The driver's door is not completely closed and the transmission is in position <b>R</b>, <b>N</b> or <b>D</b>.               <ul style="list-style-type: none"> <li>► When parking the vehicle, shift the transmission to position <b>P</b>.</li> </ul> </li> </ul>
To shift out of P or N, depress brake and start engine	<ul style="list-style-type: none"> <li>* <b>Vehicles with front-wheel drive:</b> You have tried to shift to a different transmission position from position <b>P</b> or <b>N</b>.               <ul style="list-style-type: none"> <li>► Press the brake pedal.</li> <li>► Start the engine.</li> </ul> </li> </ul>
Apply brake to deselect Park (P) position	<ul style="list-style-type: none"> <li>* You have tried to shift to a different transmission position from position <b>P</b>.               <ul style="list-style-type: none"> <li>► Press the brake pedal.</li> </ul> </li> </ul>
 <p>Vehicle positioning has been activated. Details: see manual or associated mobile app.</p>	<ul style="list-style-type: none"> <li>* The vehicle features activated services from Mercedes PRO. Positioning the vehicle may be possible as part of Mercedes PRO connect.               <ul style="list-style-type: none"> <li>► Check the status of the activated services at <a href="http://mercedes.pro">http://mercedes.pro</a>.</li> <li>► Ask the vehicle owner for the details.</li> </ul> </li> </ul>
 <p>Step not extended See Owner's Manual or step not extended malfunction</p>	<ul style="list-style-type: none"> <li>* The electrical step is not, or only partially, extended.               <ul style="list-style-type: none"> <li>► Ensure there is sufficient clearance for the electrical step.</li> <li>► Open or close the sliding door again.</li> <li>► If the electrical step does not completely extend again, slide it in manually (emergency release) (→ page 53).</li> <li>► Inform passengers that the step is missing before they exit the vehicle.</li> </ul> </li> </ul>
 <p>Step not retracted See Owner's Manual or step not retracted malfunction</p>	<ul style="list-style-type: none"> <li>* The electrical step is not, or only partially, retracted.               <ul style="list-style-type: none"> <li>► Ensure there is sufficient clearance for the electrical step.</li> <li>► Open or close the sliding door again.</li> <li>► If the electrical step does not completely retract again, slide it in manually (emergency release) (→ page 53).</li> </ul> </li> </ul>



## Lights









Display messages	Possible causes/consequences and ► Solutions
Adaptive Highbeam Assist Camera view restricted See Owner's Manual	<ul style="list-style-type: none"> <li>* The camera view is reduced. Possible causes:               <ul style="list-style-type: none"> <li>• Dirt on the windscreen in the camera's field of vision</li> <li>• Heavy precipitation or fog</li> </ul> </li> </ul> <p>Driving systems and driving safety systems may be malfunctioning or temporarily unavailable.</p> <p>When the causes have been eliminated, the driving systems and driving safety systems are available again.</p> <p>If the display message does not go out:</p> <ul style="list-style-type: none"> <li>► Stop in a safe location.</li> <li>► Clean the windscreen.</li> </ul>
Adaptive Highbeam Assist currently unavailable See Owner's Manual	<ul style="list-style-type: none"> <li>* Adaptive Highbeam Assist is temporarily unavailable. The system limits have been reached .</li> </ul> <ul style="list-style-type: none"> <li>► Continue driving. When the causes have been eliminated, the system is available again. The display message <b>Adaptive Highbeam Assist available again</b> appears.</li> </ul>
Adaptive Highbeam Assist inoperative	<ul style="list-style-type: none"> <li>* Adaptive Highbeam Assist is malfunctioning.</li> </ul> <ul style="list-style-type: none"> <li>► Visit a qualified specialist workshop.</li> </ul>
 Switch on headlamps	<ul style="list-style-type: none"> <li>* You are driving without a dipped beam.</li> </ul> <ul style="list-style-type: none"> <li>► Turn the light switch to position  or <b>AUTO</b>.</li> </ul>
 Switch off lights	<ul style="list-style-type: none"> <li>* You are leaving the vehicle and the light is still switched on.</li> </ul> <ul style="list-style-type: none"> <li>► Turn the light switch to position <b>AUTO</b>.</li> </ul>
 AUTO lights inoperative	<ul style="list-style-type: none"> <li>* The light sensor is malfunctioning.</li> </ul> <ul style="list-style-type: none"> <li>► Visit a qualified specialist workshop.</li> </ul>
 Malfunction See Owner's Manual	<ul style="list-style-type: none"> <li>* The exterior lighting is malfunctioning.</li> </ul> <ul style="list-style-type: none"> <li>► Visit a qualified specialist workshop. Vehicles with a trailer hitch: a fuse may have blown.</li> <li>► Stop in a safe location.</li> <li>► Check the fuses, and replace them if necessary(→ page 298).</li> </ul>
 Left dipped beam (example)	<ul style="list-style-type: none"> <li>* The bulb in question is faulty.</li> </ul> <ul style="list-style-type: none"> <li>► Visit a qualified specialist workshop.</li> </ul> <p>or</p> <ul style="list-style-type: none"> <li>► Check whether changing the bulb is permitted.</li> </ul> <p> LED sources: the display message for the light in question only appears if all LEDs are faulty.</p>

## Warning and indicator lamps

### Overview of warning and indicator lamps

When the ignition is switched on, many systems perform a self-test. Some warning and indicator lamps may switch on or flash temporarily during this time. This behaviour is no cause for alarm. These warning and indicator lamps only signal a malfunction if they light up or flash once the engine has been started or the vehicle is in operation.

#### Warning and indicator lamps:

	Dipped beam(→ page 82)
	Standing light(→ page 82)
	Highbeam(→ page 83)
	Turn signal light(→ page 83)
	Rear fog light(→ page 82)
	Safety belt not put on(→ page 375)
	Brakes (red)(→ page 369)
	Brakes (yellow)(→ page 369)
	ABS malfunctioning (→ page 369)



Cross-country gear

ESP® (→ page 369)

ESP® OFF (→ page 369)

Active Brake Assist deactivated  
(→ page 148)

Electric parking brake(→ page 369)  
(→ page 369)

Steering assist malfunctioning  
(→ page 375)

Electrical fault (→ page 376)

Restraint system (→ page 369)

Engine diagnosis (→ page 376)

Fuel reserve with fuel filler flap location indicator(→ page 376)

Coolant too hot/cold (→ page 376)







Distance warning (→ page 375)





Preglow



Tyre pressure monitor

### Safety systems

Warning/indicator lamp	Possible causes/consequences and ► Solutions
 <p>Restraint system warning lamp</p>	<p>The restraint system red warning lamp is on while the engine is on. The restraint system is malfunctioning.</p> <p><b>▲ WARNING</b> Risk of injury or fatal injury due to a malfunction in the restraint system</p> <p>If the restraint system is malfunctioning, restraint system components may be triggered unintentionally or might not be triggered at all in the event of an accident. This may affect the seat belt tensioner or airbag, for example.</p> <p>► Have the restraint system checked and repaired immediately at a qualified specialist workshop.</p> <p>► Continue driving carefully.</p> <p>► Read the messages on the multifunction display.</p> <p>► Visit a qualified specialist workshop immediately.</p>

Warning/indicator lamp	Possible causes/consequences and ► Solutions
 <p>Red indicator lamp, electric parking brake applied</p>  <p>Yellow electric parking brake indicator lamp is malfunctioning</p>	<p>The red parking brake indicator lamp lights up and the yellow electric parking brake indicator lamp is off.</p> <p>The red indicator lamp lights up. This means that the electric parking brake has been applied.</p> <p>The yellow indicator lamp does not light up. This means that there is no malfunction in the electric parking brake.</p> <ul style="list-style-type: none"> <li>► Do not drive the vehicle if the electric parking brake has been applied.</li> </ul>
 <p>Red indicator lamp, electric parking brake applied</p>  <p>Yellow electric parking brake indicator lamp is malfunctioning</p>	<p>The red parking brake indicator lamp is off and the yellow electric parking brake indicator lamp is lit up.</p> <p>When the indicator lamp does not light up, this means that the parking brake has been released.</p> <p>When the yellow indicator lamp lights up, this means that the electric parking brake is malfunctioning.</p> <ul style="list-style-type: none"> <li>► Observe the messages on the multifunction display.</li> <li>► Switch the ignition off and back on.</li> <li>► If the error message persists, visit a qualified specialist workshop.</li> <li>► Park the vehicle only on level ground and secure it against rolling away (→ page 142).</li> </ul>
 <p>Red indicator lamp, electric parking brake applied</p>  <p>Yellow electric parking brake indicator lamp is malfunctioning</p>	<p>The red parking brake indicator lamp is lit up and the yellow electric parking brake indicator lamp is lit up.</p> <p>When the indicator lamp lights up red, this means that the electric parking brake has been applied.</p> <p>When the yellow indicator lamp lights up, this means that the electric parking brake is malfunctioning.</p> <ul style="list-style-type: none"> <li>► Switch the ignition off and back on.</li> <li>► If the error message persists, visit a qualified specialist workshop.</li> <li>► Observe the messages on the multifunction display.</li> <li>► If it is not possible to release the electric parking brake, do not drive the vehicle.</li> </ul>



Warning/indicator lamp	Possible causes/consequences and ► Solutions
 <p>Red indicator lamp, electric parking brake applied</p>  <p>Yellow electric parking brake indicator lamp is malfunctioning</p>	<p>The red parking brake indicator lamp is flashing and the yellow electric parking brake indicator lamp is lit up.</p> <p>When the red indicator lamp flashes, this means that the activation status of the electric parking brake is unknown.</p> <p>When the yellow indicator lamp lights up, this means that the electric parking brake is malfunctioning.</p> <ul style="list-style-type: none"> <li>► Switch the ignition off and back on.</li> <li>► Engage and disengage the electric parking brake using the switch while depressing the brake pedal.</li> <li>► If the error message persists, park the vehicle on level ground and secure it against rolling away (→ page 142).</li> <li>► Consult a qualified specialist workshop.</li> <li>► When the red indicator lamp flashes, the vehicle must not be driven as the brake system may overheat.</li> </ul>
 <p>Red parking brake indicator lamp closed</p>	<p>The red parking brake indicator lamp lights up.</p> <p>When the indicator lamp lights up red, this means that the parking brake has been applied.</p> <ul style="list-style-type: none"> <li>► Do not drive the vehicle if the parking brake has been applied.</li> </ul>
 <p>ESP® OFF warning lamp</p>	<p>The ESP® OFF yellow warning lamp lights up while the engine is on. ESP® has been switched off.</p> <div style="background-color: #f0f0f0; padding: 5px;"> <p><b>▲ WARNING</b> Risk of skidding when driving with ESP® deactivated</p> <p>If ESP® is deactivated, ESP® cannot carry out vehicle stabilisation. The availability of further driving safety systems is also limited.</p> <ul style="list-style-type: none"> <li>► Drive on carefully.</li> <li>► Only deactivate ESP® for as long as the situation requires.</li> </ul> <p>If ESP® cannot be activated, ESP® is malfunctioning.</p> <ul style="list-style-type: none"> <li>► Have ESP® checked immediately at a qualified specialist workshop.</li> </ul> </div> <ul style="list-style-type: none"> <li>► Comply with instructions to switch ESP® off (→ page 147).</li> </ul>

Warning/indicator lamp	Possible causes/consequences and ► Solutions
 <p>ESP® warning lamp lights up</p>	<p>The ESP® yellow warning lamp lights up while the engine is on. ESP® is malfunctioning.</p> <p>Other driving systems and driving safety systems may also be malfunctioning.</p> <div style="border: 1px solid black; padding: 5px; margin-top: 10px;"> <p><b>▲ WARNING</b> Risk of skidding if ESP® is malfunctioning</p> <p>If ESP® is malfunctioning, ESP® cannot carry out vehicle stabilisation. In addition, other driving safety systems are switched off.</p> <ul style="list-style-type: none"> <li>► Drive on carefully.</li> <li>► Have ESP® checked at a qualified specialist workshop.</li> </ul> </div> <ul style="list-style-type: none"> <li>► Continue driving carefully.</li> <li>► Read the messages on the multifunction display.</li> <li>► Visit a qualified specialist workshop.</li> </ul>
 <p>ESP® warning lamp flashes</p>	<p>The ESP® yellow warning lamp flashes during the trip. ESP® intervenes (→ page 147).</p> <ul style="list-style-type: none"> <li>► Adapt your driving style to the weather and road conditions.</li> </ul>
 <p>ABS warning lamp</p>	<p>The ABS yellow warning lamp lights up while the engine is on. ABS is malfunctioning.</p> <p>If an additional warning tone sounds, this means the EBD is malfunctioning.</p> <p>Other driving systems and driving safety systems may also be malfunctioning.</p> <div style="border: 1px solid black; padding: 5px; margin-top: 10px;"> <p><b>▲ WARNING</b> There is risk of skidding if EBD or ABS is malfunctioning</p> <p>If EBD or ABS is malfunctioning, the wheels could lock when braking. The steering capability and braking characteristics are thus severely impaired. The braking distance may increase in an emergency braking situation. In addition, other driving safety systems are switched off.</p> <ul style="list-style-type: none"> <li>► Drive on carefully.</li> <li>► Have the brake system checked immediately at a qualified specialist workshop.</li> </ul> </div> <ul style="list-style-type: none"> <li>► Continue driving carefully.</li> <li>► Read the messages on the multifunction display.</li> <li>► Visit a qualified specialist workshop.</li> </ul>

Warning/indicator lamp	Possible causes/consequences and ► Solutions
 <p data-bbox="87 274 291 322">Brake system warning lamp (yellow)</p>	<p data-bbox="349 185 994 210">The brake system yellow warning lamp lights up while the engine is on.</p> <div data-bbox="349 229 1005 284"><p data-bbox="360 236 983 284"><b>▲ WARNING</b> Risk of an accident due to a brake system malfunction</p></div> <div data-bbox="349 293 1005 450"><p data-bbox="360 300 972 347">If the brake system is malfunctioning, braking characteristics may be impaired.</p><ul data-bbox="360 357 931 443" style="list-style-type: none"><li data-bbox="360 357 562 383">► Drive on carefully.</li><li data-bbox="360 389 931 443">► Have the brake system checked immediately at a qualified specialist workshop.</li></ul></div> <ul data-bbox="349 466 1005 574" style="list-style-type: none"><li data-bbox="349 466 965 513">► Drive carefully at an adjusted speed and at a sufficient distance from the vehicle in front.</li><li data-bbox="349 520 1005 545">► If the multifunction display shows a display message, comply with it.</li><li data-bbox="349 552 714 577">► Visit a qualified specialist workshop.</li></ul>

Warning/indicator lamp	Possible causes/consequences and ► Solutions
 <p>Brake system warning lamp (red)</p>	<p>The brake system red warning lamp lights up while the engine is on.</p> <p>Possible causes:</p> <ul style="list-style-type: none"> <li>• The brake force boosting is malfunctioning.</li> <li>• The EBD (electronic brakeforce distribution) is malfunctioning.</li> <li>• There is not enough brake fluid in the brake fluid reservoir.</li> </ul> <p><b>▲ WARNING</b> There is a risk of an accident if brake force boosting is malfunctioning</p> <p>If brake force boosting is malfunctioning, increased brake pedal force may be necessary for braking. Braking characteristics may be impaired. The braking distance may increase in an emergency braking situation.</p> <ul style="list-style-type: none"> <li>► Pull over and stop the vehicle safely as soon as possible, paying attention to road and traffic conditions. Do not continue driving under any circumstances.</li> <li>► Consult a qualified specialist workshop.</li> </ul> <p><b>▲ WARNING</b> Risk of an accident if the EBD (electronic brake force distribution) malfunctions</p> <p>If the EBD malfunctions, the wheels may lock during braking. The braking characteristics may be impaired. The braking distance can increase in emergency situations.</p> <ul style="list-style-type: none"> <li>► Stop in a safe location immediately. Do not continue driving!</li> <li>► Consult a qualified specialist workshop.</li> </ul> <p><b>▲ WARNING</b> Risk of an accident due to low brake fluid level</p> <p>If the brake fluid level is too low, the braking effect and the braking characteristics may be impaired.</p> <ul style="list-style-type: none"> <li>► Stop the vehicle as soon as possible, paying attention to road and traffic conditions. Do not continue driving.</li> <li>► Consult a qualified specialist workshop.</li> <li>► Do not top up the brake fluid.</li> </ul> <ul style="list-style-type: none"> <li>► Stop in a safe location immediately. Do not continue driving!</li> <li>► Consult a qualified specialist workshop.</li> </ul>

## Seat belt

Warning/indicator lamp	Possible causes/consequences and ► Solutions
 <p data-bbox="87 316 300 363">Seat belt warning lamp flashes</p>	<p data-bbox="348 225 1006 272">The seat belt red warning lamp flashes and an intermittent warning tone sounds.</p> <p data-bbox="348 284 1001 331">The driver or front passenger does not have their belt on during the trip (speeds above 25 km/h).</p> <ul style="list-style-type: none"> <li data-bbox="348 343 687 367">► Put on the seat belt (→ page 30).</li> <li data-bbox="348 368 770 392">There are objects on the front passenger seat.</li> <li data-bbox="348 400 846 424">► Remove the objects from the front passenger seat.</li> </ul>
 <p data-bbox="87 525 300 572">Seat belt warning lamp lights up</p>	<p data-bbox="348 435 983 491">The seat belt red warning lamp lights up once the engine has started. A warning tone may also sound.</p> <p data-bbox="348 502 1006 550">When the vehicle is stationary: The seat belt warning lamp reminds drivers and front passengers to put on their seat belt.</p> <ul style="list-style-type: none"> <li data-bbox="348 561 721 585">► Putting on the seat belt (→ page 30).</li> </ul> <p data-bbox="348 596 995 644">Objects on the front passenger seat may prevent the seat belt warning lamp from going out.</p>

## Driving systems



Warning/indicator lamp	Possible causes/consequences and ► Solutions
 <p data-bbox="87 898 300 946">Distance warning warning lamp</p>	<p data-bbox="348 807 990 863">The red distance warning lamp lights up while the vehicle is in motion. The distance to the vehicle in front is too close for the selected speed.</p> <p data-bbox="348 874 984 922">If an additional warning tone sounds, this means you are approaching an obstacle at excessive speed.</p> <ul style="list-style-type: none"> <li data-bbox="348 933 764 957">► Be ready to apply the brakes immediately.</li> <li data-bbox="348 965 583 989">► Increase the distance.</li> </ul>

## Vehicle

Warning/indicator lamp	Possible causes/consequences and ► Solutions
 <p data-bbox="87 1235 300 1283">Power steering system warning lamp</p>	<p data-bbox="348 1144 997 1200">The red power steering system warning lamp lights up while the engine is running.</p> <p data-bbox="348 1208 983 1232">The power steering assistance or the steering itself is malfunctioning.</p> <div style="border: 1px solid gray; padding: 5px; margin-top: 10px;"> <p data-bbox="362 1256 955 1279"><b>▲ WARNING</b> Risk of accident if steering capability is impaired</p> <p data-bbox="362 1294 984 1342">If the steering no longer functions as intended, the vehicle's operating safety is jeopardised.</p> <ul style="list-style-type: none"> <li data-bbox="362 1353 762 1377">► Consult a qualified specialist workshop.</li> </ul> </div> <ul style="list-style-type: none"> <li data-bbox="348 1401 824 1425">► Read the messages on the multifunction display.</li> </ul>



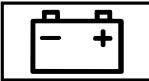

## Engine

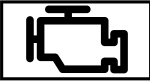
Warning/indicator lamp	Possible causes/consequences and ► Solutions
 <p data-bbox="109 316 311 339">Coolant warning lamp</p>	<p data-bbox="371 225 983 248">The red coolant warning lamp lights up while the engine is running.</p> <p data-bbox="371 256 524 280">Possible causes:</p> <ul data-bbox="371 292 804 416" style="list-style-type: none"> <li>• Temperature sensor malfunctioning</li> <li>• Coolant level too low</li> <li>• Air supply to the engine radiator obstructed</li> <li>• Engine radiator fan faulty</li> </ul> <p data-bbox="371 432 1009 480">If a warning tone also sounds, the coolant has exceeded the temperature of 120 °C.</p> <div data-bbox="371 496 1031 719" style="border: 1px solid gray; padding: 5px;"> <p data-bbox="383 504 919 528"><b>▲ WARNING</b> Danger of burns when opening the bonnet</p> <p data-bbox="383 544 997 616">If you open the engine bonnet when the engine has overheated or during a fire in the engine compartment, you could come into contact with hot gases or other escaping operating fluids.</p> <ul data-bbox="383 627 953 711" style="list-style-type: none"> <li>► Before opening the bonnet, allow the engine to cool down.</li> <li>► In the event of a fire in the engine compartment, keep the engine bonnet closed and call the fire service.</li> </ul> </div> <ul data-bbox="371 735 997 820" style="list-style-type: none"> <li>► Stop in a safe location immediately and switch off the engine. Do not continue driving!</li> <li>► Read the messages on the multifunction display.</li> </ul> <p data-bbox="371 844 1003 892">If the coolant temperature display is at the lower end of the temperature scale:</p> <ul data-bbox="371 903 768 927" style="list-style-type: none"> <li>► Consult a qualified specialist workshop.</li> </ul> <p data-bbox="371 951 471 975">Otherwise:</p> <ul data-bbox="371 986 1031 1182" style="list-style-type: none"> <li>► Leave the vehicle and keep a safe distance from the vehicle until the engine has cooled down.</li> <li>► Check the coolant level(→ page 274).</li> <li>► Ensure that the air supply to the engine radiator is not obstructed.</li> <li>► Without a high engine load, continue to the nearest qualified specialist workshop. Ensure that the coolant temperature display remains below 120 °C.</li> </ul>
 <p data-bbox="109 1284 322 1332">Electrical fault warning lamp</p>	<p data-bbox="371 1198 792 1222">The electrical fault red warning lamp lights up.</p> <p data-bbox="371 1230 770 1254">A malfunction has occurred in the electrics.</p> <ul data-bbox="371 1262 848 1286" style="list-style-type: none"> <li>► Read the messages on the multifunction display.</li> </ul>
 <p data-bbox="109 1434 303 1482">Fuel reserve warning lamp</p>	<p data-bbox="371 1348 1003 1372">The fuel reserve yellow warning lamp lights up while the engine is on.</p> <p data-bbox="371 1380 815 1404">The fuel supplies have reached the reserve level.</p> <ul data-bbox="371 1412 471 1436" style="list-style-type: none"> <li>► Refuel.</li> </ul>

Warning/indicator lamp	Possible causes/consequences and ► Solutions
 <p data-bbox="87 274 322 322">Engine diagnosis warning lamp</p>	<p data-bbox="349 185 994 233">The engine diagnosis yellow warning lamp lights up while the engine is on.</p> <p data-bbox="349 242 994 290">A malfunction has occurred in the engine, exhaust system or fuel system.</p> <p data-bbox="349 300 994 347">This can cause the emission values to be exceeded and the engine to run in emergency mode.</p> <p data-bbox="349 357 994 405">► Have the vehicle checked in a qualified specialist workshop as quickly as possible.</p>

## Tyres

Warning/indicator lamp	Possible causes/consequences and ► Solutions
 <p data-bbox="87 654 322 734">Tyre pressure monitoring system warning lamp flashes</p>	<p data-bbox="349 564 976 644">The tyre pressure yellow monitor warning lamp (pressure loss / malfunction) flashes for roughly one minute and then lights up permanently.</p> <p data-bbox="349 651 752 676">The tyre pressure monitor is malfunctioning.</p> <div data-bbox="349 692 1005 756" style="background-color: #f0f0f0; padding: 5px;"> <p data-bbox="360 699 954 753">▲ <b>WARNING</b> There is a risk of an accident if the tyre pressure monitoring system is malfunctioning</p> </div> <p data-bbox="365 762 960 842">If the tyre pressure monitoring system is malfunctioning, it is not able to issue a warning if there is pressure loss in one or more of the tyres.</p> <p data-bbox="365 849 954 896">Tyres with insufficient tyre pressure may, for example, affect the vehicle's handling characteristics, steering and braking. -</p> <p data-bbox="365 903 960 960">► Have the tyre pressure monitoring system checked at a qualified specialist workshop.</p> <p data-bbox="349 979 714 1005">► Visit a qualified specialist workshop.</p>

Warning/indicator lamp	Possible causes/consequences and ► Solutions
 <p data-bbox="112 276 341 347">Tyre pressure monitoring system warning lamp lights up</p>	<p data-bbox="370 188 999 236">The tyre pressure monitor yellow warning lamp (pressure loss / malfunction) lights up.</p> <p data-bbox="370 244 1014 292">The tyre pressure monitor has detected a tyre pressure loss in at least one tyre.</p> <div data-bbox="370 316 1031 675" style="border: 1px solid black; padding: 5px;"><p data-bbox="387 320 1009 344"><b>▲ WARNING</b> Risk of an accident due to insufficient tyre pressure</p><p data-bbox="387 360 941 384">Tyres with insufficient tyre pressure pose the following risks:</p><ul data-bbox="398 392 981 560" style="list-style-type: none"><li data-bbox="398 392 981 440">• The tyres may burst, especially as the load and vehicle speed increase.</li><li data-bbox="398 448 981 496">• The tyres may wear excessively and/or unevenly, which may greatly impair tyre traction.</li><li data-bbox="398 504 981 560">• - The driving characteristics, steering and braking may be greatly impaired.</li></ul><p data-bbox="387 576 770 600">You could then lose control of the vehicle.</p><ul data-bbox="387 608 813 663" style="list-style-type: none"><li data-bbox="387 608 813 632">► Observe the recommended tyre pressures.</li><li data-bbox="387 639 813 663">► Adjust the tyre pressure if necessary.</li></ul></div> <ul data-bbox="370 687 757 746" style="list-style-type: none"><li data-bbox="370 687 757 711">► Stop the vehicle in a safe location.</li><li data-bbox="370 719 757 746">► Check the tyre pressure and the tyres.</li></ul>

- 1, 2, 3 ...**
- 12 V socket**  
see Socket (12 V)
- 230 V socket**  
see Socket (230 V) (centre console, front)
- 360° Camera** ..... 159  
Care ..... 279  
Function ..... 159  
Selecting a view ..... 161
- A**
- ABS (Anti-lock Braking System)** ..... 146
- Acceleration**  
see Using kickdown
- Access data**  
Setting (Bluetooth®) ..... 251
- Acoustic locking verification signal**  
Activating/deactivating ..... 42
- Activating/deactivating air-recirculation mode** ..... 101
- Activating/deactivating the synchronisation function (control panel)** ..... 101
- Active Brake Assist** ..... 148  
Function/notes ..... 148  
Setting ..... 150
- Active Distance Assist DISTRONIC** .... 153  
Calling up a speed ..... 154  
Function ..... 153  
Increasing/reducing the speed ..... 154  
Requirements: ..... 154  
Steering-wheel buttons ..... 154  
Storing a speed ..... 154  
Switching off/deactivating ..... 154  
Switching on/activating ..... 154  
System limitations ..... 153
- Active Lane Keeping Assist** ..... 166  
Function ..... 166  
System limitations ..... 166  
Trailer operation ..... 166
- Active Parking Assist**  
Manoeuvring assistance ..... 161
- Adaptive brake lights** ..... 150
- Adaptive cruise control**  
see Active Distance Assist DISTRONIC
- Adaptive Highbeam Assist**  
Function ..... 84  
switching on/off ..... 85
- AdBlue®** ..... 135, 338  
Additive ..... 135, 338  
Filling capacity ..... 338  
Purity ..... 135, 338  
Topping up ..... 136
- Add-on equipment** ..... 20
- Add-on equipment guidelines** ..... 20
- Additional door lock** ..... 43
- Additional turn signal light (all-wheel drive vehicles)** ..... 89
- Additive** ..... 339  
AdBlue® ..... 135, 338  
Engine oil ..... 339
- Additives (AdBlue®)**  
see AdBlue®
- Additives (engine oil)**  
see Additive
- Address book**  
see Contacts
- Adjusting ventilation nozzles (roof)** .... 103
- ADR (working speed control)**  
Adjusting ..... 169  
Function ..... 168  
Switching on/off ..... 169
- After-sales service centre**  
see ASSYST PLUS
- Air nozzles**  
see Adjusting ventilation nozzles (roof)  
see Air vents
- Air recirculation button**  
Convenience opening/closing ..... 102
- Air vents** ..... 102  
adjusting (front) ..... 102  
Rear ..... 103
- Airbag** ..... 31  
Activation ..... 28  
Front airbag (driver, front passenger) ..... 31  
Installation locations ..... 31  
Overview ..... 31  
Protection ..... 31  
Reduced protection ..... 32  
Side impact airbag ..... 31  
Window airbag ..... 31
- Alarm system**  
see ATA (Anti-theft Alarm system)
- Alertness assistant**  
see ATTENTION ASSIST

- All-wheel drive**  
 Engaging ..... 127  
 Engaging/disengaging ..... 128  
 LOW range ..... 128  
 Notes ..... 127
- Alternative route**  
 see Route
- Android Auto** ..... 244  
 Connecting a mobile phone ..... 245  
 Ending ..... 245  
 Note ..... 245  
 Overview ..... 244  
 Sound settings ..... 245  
 Transferred vehicle data ..... 245
- Animals**  
 Pets in the vehicle ..... 40
- Anti-lock braking system**  
 see ABS (Anti-lock Braking System)
- Anti-skid chains**  
 see Snow chains
- Anti-theft Alarm system**  
 see ATA (Anti-theft Alarm system)
- Anti-theft protection**  
 Additional door lock ..... 43  
 Immobiliser ..... 57
- Anti-theft protection**  
 see ATA (Anti-theft Alarm system)
- Apple CarPlay™** ..... 243  
 Connecting an iPhone® ..... 244  
 Ending ..... 244  
 Notes ..... 244  
 Overview ..... 243  
 Sound settings ..... 244  
 Transferred vehicle data ..... 245
- Aquaplaning** ..... 116
- Ashtrays**  
 in the windscreen stowage compartment ..... 77
- ASR (acceleration skid control)** ..... 146
- Assistance graphic (on-board computer)** ..... 178
- ASSYST PLUS** ..... 270  
 Battery disconnection periods ..... 270  
 Displaying the service due date ..... 270  
 Function/notes ..... 270  
 Regular maintenance work ..... 270  
 Special service requirements ..... 270
- ATA (Anti-theft Alarm system)** ..... 57  
 Function ..... 57  
 Interior motion sensor function ..... 59
- Priming/deactivating the interior motion sensor ..... 59  
 Stopping the alarm ..... 58  
 Switching tow-away protection on/off ..... 58  
 Tow-away protection function ..... 58
- Attachments** ..... 20
- ATTENTION ASSIST** ..... 161, 162  
 Function ..... 161  
 Setting ..... 162  
 System limitations ..... 161
- Authorised workshop**  
 see Qualified specialist workshop
- Automatic dipped beam** ..... 82
- Automatic distance adjustment**  
 see Active Distance Assist DISTRONIC
- Automatic engine start (ECO start/stop function)** ..... 120
- Automatic engine stop (ECO start/stop function)** ..... 120
- Automatic transmission**  
 DIRECT SELECT lever ..... 123  
 Engage park position ..... 125  
 Engaging drive position ..... 125  
 Engaging neutral ..... 124  
 Engaging reverse gear ..... 124  
 Kickdown ..... 126  
 Restricting the shift range ..... 125  
 Transmission position display ..... 123  
 Transmission positions ..... 123
- Auxiliary heating**  
 Timer overview ..... 107
- Auxiliary warm-air heater**  
 Immediate heating mode ..... 108  
 Problems ..... 108  
 Setting the departure time ..... 108  
 Setting the temperature/operating duration ..... 108  
 Setting the timer ..... 107  
 Timer overview ..... 107
- Axle load** ..... 334

## B

- Back support**  
 see Lumbar support (4-way)
- Ball coupling**  
 attaching ..... 171, 172
- BAS (Brake Assist System)** ..... 146
- Battery**  
 Charging ..... 286

- Charging a vehicle battery ..... 286
  - Disconnecting the auxiliary battery in the engine compartment ..... 292
  - Disconnecting the auxiliary battery under the co-driver's seat ..... 292
  - Disconnecting the starter battery .... 288
  - Jump-starting (vehicle) ..... 286
  - Key ..... 42
  - Notes (vehicle) ..... 284
  - Remote control (stationary heating) ..... 106
  - Removing or fitting the starter battery ..... 289
  - Starter battery ..... 288
  - Battery main switch**
    - Switching the power supply on/off .. 122
  - Belt**
    - see Seat belt
  - Blind Spot Assist** ..... 164
    - Activating/deactivating ..... 165
    - Function ..... 164
    - Rear Cross Traffic Alert ..... 165
    - System limitations ..... 164
  - BlueTEC**
    - see AdBlue®
  - Bluetooth®** ..... 205
    - Information ..... 205
    - Setting up an Internet connection .... 251
    - Switching on/off ..... 205
  - Bottle holder** ..... 77
  - Brake**
    - ABS (Anti-lock Braking System) ..... 146
    - Active Brake Assist ..... 148
    - Adaptive brake lights ..... 150
    - BAS (Brake Assist System) ..... 146
    - Braking with parking brake: ..... 115
    - Downhill gradient ..... 115
    - Driving tips ..... 112
    - EBD (Electronic Brakeforce Distribution) ..... 148
    - Heavy and light loads ..... 115
    - HOLD function ..... 155
    - New brake discs and brake pads/linings ..... 115
    - New/replaced brakepads/brake discs ..... 112
    - Restricted braking effect (salt-treated roads) ..... 112
    - Running-in notes ..... 112
    - Wet road surfaces ..... 115
  - Brake Assist System**
    - see BAS (Brake Assist System)
  - Brake Assistance**
    - see BAS (Brake Assist System)
  - Brake fluid**
    - Notes ..... 339
  - Brakeforce Distribution**
    - EBD (Electronic Brakeforce Distribution) ..... 148
  - Breakdown**
    - Changing a wheel ..... 321
    - Overview of help ..... 16
    - Tow starting ..... 297
    - Towing away ..... 294
    - Transporting the vehicle ..... 296
  - Breakdown**
    - see Flat tyre
  - Bulbs**
    - Reversing light ..... 91
  - Buttons**
    - Steering wheel ..... 175
- C
- Call list**
    - Making a call ..... 241, 242
    - Overview ..... 241
    - Selecting options for suggestions ..... 241, 242
  - Calls** ..... 238
    - Accepting ..... 238
    - Activating functions during a call .... 238
    - Calls with several participants ..... 238
    - Declining ..... 238
    - Ending a call ..... 238
    - Incoming call during an existing call ..... 239
    - Making ..... 238
  - Camera**
    - see 360° Camera
    - see Reversing camera
  - Car wash**
    - see Care
  - Car wash (care)** ..... 278
  - Car-to-X-Communication**
    - Displaying hazard warnings ..... 228
    - Overview ..... 228
    - Sending hazard warnings ..... 229
  - Care** ..... 281
    - Automatic car wash ..... 278
    - Carpet ..... 281
    - Display ..... 281
    - Exterior lighting ..... 279
    - High-pressure cleaner ..... 278















- Matt finish ..... 278
- Paint ..... 278
- Plastic trim ..... 281
- Real wood/trim elements ..... 281
- Reversing camera/360° Camera ..... 279
- Roof lining ..... 281
- Seat belt ..... 281
- Seat cover ..... 281
- Sensors ..... 279
- Tailpipes ..... 279
- Trailer hitch ..... 279
- Washing by hand ..... 278
- Wheels/rims ..... 279
- Windows ..... 279
- Wiper blades ..... 279
- Carpet (care)** ..... 281
- Change a bulb**  
see Change bulbs
- Change bulbs** ..... 87
  - Additional turn signal light (all-wheel drive vehicles) ..... 89
  - Notes ..... 87
- Changing a wheel**
  - Lowering the vehicle ..... 326
  - Preparing ..... 321
  - Raising the vehicle ..... 322
  - Removing a wheel ..... 324
- Changing bulbs**
  - Dipped beam ..... 88
  - High beam ..... 88
  - Indicator (front) ..... 88
  - Indicators (rear) (panel van and crewbus) ..... 89
  - Interior lamps (rear) ..... 92
  - Licence plate lighting ..... 90
  - Light bulb types halogen headlamps .. 88
  - Reversing lights (panel van and crewbus) ..... 89
  - Side marker lamps ..... 92
  - Tail lamp bulb types (chassis) ..... 91
  - Tail lamp bulb types (panel van and crewbus) ..... 89
  - Turn signal light (rear) (chassis) ..... 91
- Changing lamp**  
see Change bulbs
- Charging**
  - Battery ..... 286
  - Mobile phone (wireless) ..... 80
- Child safety lock (doors)** ..... 39
- Child seat**
  - Attaching (notes) ..... 36
  - Front passenger seat (notes) ..... 36
  - Front passenger seat (rearward-facing/forward-facing) ..... 36
  - ISOFIX (fitting) ..... 34
  - ISOFIX (notes) ..... 34
  - Notes on the safe transportation of children ..... 32
  - Rearward-facing child restraint system (Information) ..... 36
  - Recommended child restraint systems ..... 39
  - Seats suitable for belt-secured child restraint systems ..... 37
  - Top Tether ..... 35
- Children**
  - Notes on safe transportation ..... 32
- Chock (rear wheel drive)** ..... 16
- Cleaning**  
see Care
- Cleaning water drain valve of the air intake box** ..... 276
- Climate control**
  - Activating/deactivating air-recirculation mode ..... 101
  - Activating/deactivating the synchronisation function (control panel) ..... 101
  - Air distribution settings ..... 101
  - automatically controlling (rear) ..... 100
  - Demisting the windows ..... 101
  - Hot-water auxiliary heater ..... 104
  - Refrigerant ..... 341
  - Setting automatic mode ..... 100
  - Setting the air distribution ..... 101
  - Setting the rear compartment heating ..... 100
  - Switching on/off ..... 99
  - Switching the A/C function on or off ..... 100
  - Switching the rear window heater on and off ..... 102
  - Switching the windscreen heater on and off ..... 102
  - TEMPMATIC control panel ..... 98
  - THERMOTRONIC control panel ..... 99
  - Ventilating the vehicle (convenience opening) ..... 56
  - Ventilation nozzles at front ..... 102
  - Ventilation nozzles in the roof ..... 103
  - Ventilation nozzles, rear ..... 103
- Co-driver bench seat** ..... 67
  - Stowage box ..... 75
- Cockpit (overview)** ..... 4







































<b>Combination switch</b>	
see Headlamp flasher	
see High beam	
see Indicator	
<b>Compass</b> .....	232
<b>Computer</b>	
see On-board computer	
<b>Connection status</b>	
Displaying .....	252
Overview .....	252
<b>Contacts</b> .....	239
Calling up .....	239
Deleting .....	241
Deleting favourites .....	241
Downloading (from mobile phone) ...	239
Importing .....	240
Importing (overview) .....	240
Information .....	239
Making a call .....	240
Name format .....	240
Options .....	240
Saving as a favourite .....	241
Selecting options for suggestions .....	240
Storing .....	240
<b>Convenience closing</b> .....	56
<b>Convenience opening</b> .....	56
<b>Convenience opening/closing via the air recirculation button</b> .....	102
<b>Conversions</b> .....	20
<b>Coolant (engine)</b>	
Checking level .....	274
Notes .....	340
<b>Copyright</b> .....	26
<b>Cornering light</b> .....	84
<b>Crosswind Assist</b>	
Function/notes .....	147
<b>Cruise control</b> .....	150
Buttons .....	151
Calling up a speed .....	151
Function .....	150
Requirements .....	151
Selecting .....	151
Setting a speed .....	151
Storing a speed .....	151
Switching off .....	151
Switching on .....	151
System limitations .....	150



















**D**

<b>Dashboard</b>	
see Cockpit (overview)	
<b>Dashboard lighting</b>	
see Instrument lighting	
<b>Data import/export</b> .....	208
Function/notes .....	208
Importing/exporting .....	208
<b>Data recording (vehicle)</b> .....	24
<b>Date</b>	
Setting the time and date automat- ically .....	205
<b>Declaration of conformity</b>	
Electromagnetic compatibility .....	22
Jack .....	22
Wireless vehicle components .....	22
<b>Destination</b> .....	225
Editing intermediate destinations .....	219
Editing the previous destinations .....	225
Saving (current vehicle position) .....	225
<b>Destination entry</b> .....	212, 214
Entering 3 word addresses .....	215
Entering a POI or address .....	212
Entering an intermediate destina- tion .....	219
Entering geo-coordinates .....	215
Notes .....	212
Selecting a contact .....	215
Selecting a POI .....	214
Selecting from global favourites .....	216
Selecting from the map .....	215
Selecting previous destinations .....	213
<b>Detecting inattentiveness</b>	
see ATTENTION ASSIST	
<b>Diagnostics connection</b> .....	23
<b>Dial telephone number (on-board computer)</b> .....	181
<b>Diesel</b>	
Low outside temperatures .....	336
Notes .....	336
<b>Diesel particulate filter</b>	
Automatic regeneration .....	121
Cancelling regeneration .....	121
Notes .....	121
Starting regeneration .....	121
<b>Digital Owner's Manual</b> .....	18
<b>Digital speedometer</b> .....	178
<b>Dimming the inside mirror</b> .....	96



- Dipped beam**  
 Changing bulbs ..... 88  
 Setting for abroad (symmetrical) ..... 82  
 switching on/off ..... 82
- Dipped beam**  
 see Automatic dipped beam
- DIRECT SELECT lever** ..... 123  
 Engaging drive position ..... 125  
 Engaging neutral ..... 124  
 Engaging park position automatically ..... 125  
 Engaging reverse gear ..... 124  
 Function ..... 123  
 Selecting park position ..... 125
- Direction indicator**  
 see Indicator
- Display (care)** ..... 281
- Display (multimedia system)**  
 Home screen ..... 193  
 Notes ..... 192  
 Operating ..... 194  
 Settings ..... 204
- Display (on-board computer)** ..... 176
- Display message** ..... 345  
 calling up (on-board computer) ..... 345  
 Notes ..... 345
- Display messages**  
 ..... 355  
 ..... 352  
 Active Brake Assist Functions currently limited See Owner's Manual ... 349  
 Active Brake Assist Functions limited See Owner's Manual ..... 349  
 Active Distance Assist inoperative ... 352  
 Active Lane Keeping Assist Camera view restricted See Owner's Manual ..... 354  
 Active Lane Keeping Assist currently unavailable See Owner's Manual ..... 355  
 Active Lane Keeping Assist inoperative ..... 355  
 Adaptive Highbeam Assist Camera view restricted See Owner's Manual ..... 368  
 Adaptive Highbeam Assist currently unavailable See Owner's Manual ..... 368  
 Adaptive Highbeam Assist inoperative ..... 368  
 AdBlue system fault Engine start not possible ..... 360  
 AdBlue system fault Perf. reduced in XXX miles See Owner's Manual ..... 360  
 AdBlue system fault Perf. reduced: 12 mph No start in XXX miles ..... 360  
 AdBlue system fault Performance reduced after eng. restart: XXX mph ..... 361  
 AdBlue system fault Performance reduced: 12 mph ..... 361  
 AdBlue system fault Performance reduced ..... 361  
 AdBlue system fault See Owner's Manual ..... 360, 361  
 Add 1 litre engine oil when next refuelling ..... 356  
 Air conditioning malfunction See Owner's Manual ..... 366  
 Apply brake to deselect Park (P) position ..... 367  
 Attention Assist inoperative ... 355  
 Attention Assist: Pause! ..... 355  
 AUTO lights inoperative ..... 368  
 Backup battery malfunction ..... 366  
 Before starting the engine, turn the steering wheel ..... 365  
 Blind Spot Assist currently unavailable See Owner's Manual ..... 354  
 Blind Spot Assist inoperative ..... 354  
 Cannot measure fluid level ..... 360  
 Change key batteries ..... 364  
 Check brake fluid level ..... 348  
 Check brake pads See Owner's Manual ..... 348

 Check engine oil level when next refuelling .....	357	 Key not detected (red display message) .....	363
 Check tyre(s) .....	362	 Key not detected (white display message) .....	364
 Clean the fuel filter .....	355	 Left dipped beam (example) ....	368
 Coolant Stop vehicle Switch engine off .....	358	 Left windowbag malfunction Consult workshop (example) .....	345
 Correct tyre pressure .....	362	 Malfunction See Owner's Manual .....	368
Cruise control and speed limiter inoperative .....	352	 Maximum speed exceeded .....	352
Cruise control inoperative .....	352	N permanently active Risk of vehicle rolling .....	367
Currently unavailable Camera dirty ..	353	 Off .....	352
Currently unavailable Radar sensors dirty .....	353	 Off .....	353
 currently unavailable See Owner's Manual .....	351	Only select Park (P) when vehicle is stationary .....	367
 currently unavailable See Owner's Manual .....	350	 Parking brake inoperative .....	347
Distance Pilot available again .....	353	 Parking brake See Owner's Manual .....	348
Distance Pilot currently unavailable See Owner's Manual .....	352	 Place the key in the marked space See Owner's Manual .....	363
 .....	352	Radar sensors dirty See Owner's Manual .....	349
 Engine oil level cannot be measured .....	356	 Refill AdBlue Engine start not possible .....	359
 Engine oil level Reduce oil level .....	356	 Replace air filter .....	355
 Engine oil level Stop vehicle Switch engine off .....	356	 Replace key .....	364
 Engine oil pressure Stop Switch off engine .....	356	 Reserve fuel level .....	355
 Front left malfunction Consult workshop (example) .....	346	 Restraint system malfunction Consult workshop .....	346
 Incline too steep See Owner's Manual .....	347	Reversing not possible: Consult workshop .....	366
 inoperative Battery low .....	365	Risk of vehicle rolling Driver's door open and transmission not in P .....	367
 inoperative Refuel vehicle .....	365	 See Owner's Manual .....	357
 inoperative See Owner's Manual .....	351	SOS NOT READY .....	349
 inoperative See Owner's Manual .....	364	Speed limit (winter tyres) XXX km/h .....	352
 inoperative See Owner's Manual .....	350	Speed limiter inoperative .....	352
 inoperative See Owner's Manual .....	350	Speed limiter passive .....	352
		 Start engine See Owner's Manual .....	357

-  Steering malfunction  
Increased physical effort See Owner's Manual ..... 365
-  Steering malfunction See Owner's Manual ..... 365
-  Steering malfunction Stop immediately See Owner's Manual .... 366  
Step not extended See Owner's Manual or step not extended malfunction ..... 367
-  Stop vehicle Leave engine running ..... 357
-  Stop vehicle See Owner's Manual ..... 357
-  Switch off lights ..... 368
-  Switch on headlamps ..... 368
-  System fault No start in XXX miles ..... 359  
To select R, depress brake ..... 366  
To shift out of P or N, depress brake and start engine ..... 367  
To start engine, shift to P or N ..... 366
-  Top up AdBlue No start in XXX miles ..... 359
-  Top up AdBlue Perf. reduced in XXXmiles See Owner's Manual .... 359
-  Top up AdBlue Perf. reduced: 12 mph No start in XXX miles ..... 359
-  Top up AdBlue Performance reduced after eng. restart: 12 mph ... 361
-  Top up AdBlue Performance reduced ..... 360
-  Top up AdBlue Power reduced: 12 mph ..... 361
-  Top up AdBlue See Owner's Manual ..... 359, 360  
Top up coolant See Owner's Manual ..... 358
-  Top up washer fluid ..... 364  
Totwinkel-Assistent Anhänger nicht überwacht ..... 354  
Traffic Sign Assist Camera view restricted See Owner's Manual ..... 354  
Traffic Sign Assist currently unavailable See Owner's Manual ..... 354  
Traffic Sign Assist inoperative ..... 353  
Transmission malfunction Stop ..... 366  
Tyre pressure Check tyre(s) ..... 363  
Tyre pressure monitor currently unavailable ..... 362  
Tyre pressure monitor inoperative .... 363  
Tyre pressure monitor inoperative No wheel sensors ..... 361
-  Vehicle is operational Switch off the ignition before exiting ..... 366  
Vehicle positioning has been activated. Details: see manual or associated mobile app. .... 367
-  Warning tyre defect ..... 362
-  Wheel sensor(s) missing ..... 361  
Without changing gear, consult workshop ..... 367
- Display range (trip menu) ..... 178**
- Display total distance (trip menu) ..... 178**
- Distance adjustment**  
see Active Distance Assist DISTRONIC
- Distance control**  
see Active Distance Assist DISTRONIC
- Distance recorder**  
see Trip distance
- DISTRONIC**  
see Active Distance Assist DISTRONIC
- Door**  
Additional door lock ..... 43  
Locking (emergency key element) ..... 45  
Unlocking (emergency key element) ... 45
- Door control panel ..... 14**
- Double co-driver's seat ..... 67**
- Drinking and driving ..... 112**
- Drive Away Assist ..... 165**
- Driver's seat**  
see Seats
- Driving characteristics (unusual) ..... 301**
- Driving instructions**  
Driving abroad (symmetrical dipped beam) ..... 82  
Foreign trip (information) ..... 114

**Driving Safety System**

ABS (Anti-lock Braking System) .....	146
Adaptive brake lights .....	150
ASR (acceleration skid control) .....	146
BAS (Brake Assist System) .....	146
EBD (Electronic Brakeforce Distribution) .....	148
ESP® (Electronic Stability Program) trailer stabilisation .....	148
ESP® Crosswind Assist .....	147
Overview .....	145
Radar sensors .....	145
Responsibility .....	145

**Driving safety system**

see Active Brake Assist
see ESP® (Electronic Stability Program)

**Driving system**

see 360° Camera
see Active Distance Assist DISTRONIC
see Active Lane Keeping Assist
see ATTENTION ASSIST
see Blind Spot Assist
see Cruise control
see HOLD function
see Lane Keeping Assist
see Limiter
see Parking Assist PARKTRONIC
see Reversing camera
see Traffic Sign Assist

**Driving tips**

Aquaplaning .....	116
Brake subject to load .....	115
Braking .....	115
Downhill gradient .....	115
Drinking and driving .....	112
Driving in winter .....	116
Driving off-road .....	117
Driving on flooded roads .....	116
Driving on wet roads .....	116
General driving tips .....	112
Mountainous terrain .....	119
New brake discs and brake pads/linings .....	115
Parking brake .....	115
Running-in notes .....	112
Transport by rail .....	114
Wet road surfaces .....	115

**Drowsiness detection**

see ATTENTION ASSIST
----------------------

**DSR (Downhill Speed Regulation)**

Activating/deactivating .....	129
Notes .....	128

**E****EBD (Electronic Brakeforce Distribution)**

148

**ECO display**

Function .....	120
Resetting .....	179

**ECO start/stop function**

120

Activate/deactivate .....	120
Automatic engine start .....	120
Automatic engine stop .....	120
Operation .....	120

**Electric parking brake**

142

Applying automatically .....	142
Applying or releasing manually .....	143
Emergency braking .....	144
Notes .....	142
Releasing automatically .....	143

**Electric sliding door**

Function .....	47
Opening with the door handle .....	48
Opening/closing with the key .....	48
Programming the key .....	48
Resetting .....	50
Unlocking manually .....	49

**Electrical closing assist**

Notes .....	47
-------------	----

**Electrical consumption**

Key .....	42
-----------	----

**Electrical fuses**

see Fuses
-----------

**Electrical sliding door**

Opening with button .....	47
---------------------------	----

**Electrical step**

emergency release .....	53
Function .....	52
Obstacle .....	52
Prevent extending .....	52
retract/extend .....	52

**Electromagnetic compatibility (declaration of conformity)**

22

**Electronic Stability Program**

see ESP® (Electronic Stability Program)
---

**Electronics** 333**Emergency**

Fire extinguisher .....	283
First-aid kit (soft-sided) .....	283
Overview of help .....	16
Removing the warning triangle .....	283
Safety vest .....	283
Setting up the warning triangle .....	283

- Emergency braking**  
 Electric parking brake ..... 144  
 Manual parking brake ..... 142
- Emergency call system**  
 see Mercedes-Benz emergency call system
- Emergency engine start** ..... 297
- Emergency key element**  
 Locking door ..... 45  
 Removing/inserting ..... 42  
 Unlocking door ..... 45
- Engaging drive position (automatic transmission)** ..... 125
- Engaging neutral (automatic transmission)** ..... 124
- Engaging reverse gear** ..... 124
- Engaging/disengaging LOW RANGE** ... 128
- Engine**  
 ECO start/stop function ..... 120  
 Engine number ..... 334  
 Jump-starting ..... 286  
 Parking (start/stop button) ..... 140  
 Starting (start/stop button) ..... 111
- Engine data**  
 Indicators ..... 210
- Engine electronics (notes)** ..... 333
- Engine number** ..... 334
- Engine oil** ..... 273  
 Additive ..... 339  
 Checking the oil level (on-board computer) ..... 272  
 Filling capacity ..... 339  
 Topping up ..... 273
- Engine output**  
 Notes on changes ..... 23
- ENR (electronic level control)** ..... 129  
 Function ..... 129  
 Lowering the vehicle ..... 131  
 Manually inflating air bellows ..... 132  
 Problems ..... 132  
 Raising the vehicle ..... 131
- Entering characters**  
 Function/notes ..... 202  
 Setting the keyboard ..... 204  
 Using the media display ..... 203
- Environmental protection**  
 Notes ..... 19  
 Take-back of end-of-life vehicles ..... 19
- ERA-GLONASS test mode**  
 Starting/ending ..... 250
- ESC (Electronic Stability Control)**  
 see ESP® (Electronic Stability Program)
- ESP®**  
 Crosswind Assist ..... 147  
 Trailer stabilisation ..... 148
- ESP® (Electronic Stability Program)** ... 147  
 Activating/deactivating ..... 147  
 Function/notes ..... 147
- Exterior lighting**  
 Care ..... 279
- Exterior lighting**  
 see Lights
- F**
- Fatigue detection**  
 see ATTENTION ASSIST
- Fault message**  
 see Display message
- Favourites**  
 Adding ..... 199  
 Calling up ..... 199  
 Deleting ..... 200  
 Moving ..... 199  
 Overview ..... 199  
 Renaming ..... 199
- Filling station search**  
 Starting an automatic filling station search ..... 220  
 Switching the automatic filling station search on/off ..... 220
- Filling up the windscreen washing system** ..... 275
- Fire extinguisher** ..... 283
- First-aid kit (soft-sided)** ..... 283
- Flat tyre** ..... 284  
 Changing a wheel ..... 321  
 Notes ..... 284
- Floor covering**  
 Fitting/removing (starter battery) .... 288
- Floor mats** ..... 81
- Foreign trip**  
 Instructions ..... 114  
 symmetrical dipped beam ..... 82
- Free software** ..... 26
- Frequencies**  
 Mobile phone ..... 333  
 Two-way radio ..... 333
- Front airbag (driver, front passenger)** .. 31

- Front door**  
 Opening (from inside) ..... 44  
 Unlocking (from inside) ..... 44
- Front seats**  
 8-way adjustment options ..... 63  
 adjusting (electrically) ..... 63  
 Adjusting (manually) ..... 60, 62  
 Memory function ..... 63  
 rotate ..... 66  
 With Seat Comfort Package ..... 62  
 Without Seat Comfort Package ..... 60
- Fuel**  
 Diesel ..... 336  
 Draining the filter ..... 276  
 Fuel reserve ..... 337  
 Low outside temperatures ..... 336  
 Quality (diesel) ..... 336  
 Refuelling ..... 133  
 Tank capacity ..... 337
- Fuel consumption (on-board computer)** ..... 178
- Fuel consumption display**  
 Calling up ..... 210
- Fuses** ..... 298, 299  
 Before replacing ..... 298  
 Fuse box in the co-driver footwell ..... 299  
 Fuse box in the seat base of the driver's seat ..... 298  
 Notes ..... 298
- G**
- Gearshift lever** ..... 122
- Gearshift recommendation** ..... 123
- General operating permit number (EU)** ..... 334
- Glasses compartment** ..... 75
- Global search**  
 Function ..... 201  
 Overview ..... 201
- Gross mass** ..... 334
- H**
- Handbrake (electrical)**  
 see Electric parking brake
- Handbrake (manual)**  
 see Manual parking brake
- Handling control system**  
 see ESP® (Electronic Stability Program)
- Hazard warning lights** ..... 84
- Head restraint**  
 Adjusting mechanically ..... 71
- Headlamp flasher** ..... 83
- Heating system (control panel)** ..... 97
- High beam** ..... 83  
 Activating/deactivating ..... 83  
 Changing bulbs ..... 88
- High-pressure cleaner (care)** ..... 278
- Highbeam**  
 Adaptive Highbeam Assist ..... 84
- Hill start assist** ..... 155
- HOLD function** ..... 155
- Home screen (media display)** ..... 193
- Hot-water auxiliary heater** ..... 104  
 Displays (remote control) ..... 105  
 Function ..... 104  
 switching on/off by remote control ..... 105  
 switching on/off with the button ..... 104  
 Switching on/off with the on-board computer ..... 106
- Hotspot**  
 Setting up (Wi-Fi) ..... 207
- I**
- Identification plate**  
 Engine ..... 334  
 Refrigerant ..... 341  
 Vehicle ..... 334
- Ignition key**  
 see Key
- Immobiliser** ..... 57
- Implied warranty (vehicle)** ..... 24
- Indicator** ..... 83  
 Activating/deactivating ..... 83  
 Changing bulbs (front) ..... 88  
 Changing bulbs (rear) (chassis) ..... 91  
 Changing bulbs (rear) (panel van and crewbus) ..... 89
- Installations** ..... 20
- Instrument display**  
 Function/notes ..... 174  
 Overview ..... 5, 174  
 Setting the lighting ..... 177
- Instrument display**  
 see Warning/indicator lamp
- Instrument lighting** ..... 177
- Intelligent light system**  
 Adaptive Highbeam Assist ..... 84

- Cornering light ..... 84
  - Interior lamps (rear) (replacing the light bulbs)** ..... 92
  - Interior lighting**
    - Load compartment ..... 86
    - Rear ..... 86
    - Setting ..... 85
    - Switch-off delay time ..... 87
  - Interior motion sensor**
    - Function ..... 59
    - Priming/deactivating ..... 59
  - Interior roof carrier system** ..... 267
  - Intermediate destination**
    - Calculating a route with intermediate destinations ..... 219
    - Editing ..... 219
    - Entering ..... 219
    - Starting an automatic filling station search ..... 220
    - Starting the automatic service station search ..... 220
  - Internet**
    - Calling up a web page ..... 252
    - Closing the browser ..... 254
    - Deleting a bookmark ..... 254
    - Deleting history ..... 254
    - Managing bookmarks ..... 254
  - Internet connection**
    - Automatic disconnection ..... 252
    - Cancelling permission (mobile phone) ..... 252
    - Connection status ..... 252
    - Disconnection following Inactivity .... 252
    - Displaying the connection status .... 252
    - Establishing ..... 252
    - Information ..... 250
    - Mobile phone details ..... 252
    - Restrictions ..... 250
    - Setting access data ..... 251
    - Setting up (Bluetooth®) ..... 251
    - Setting up (Wi-Fi) ..... 251
    - Via communication module ..... 251
  - Internet radio**
    - Calling up ..... 254
    - Calling up the station list (category last selected) ..... 256
    - Deleting stations ..... 255
    - Logging out ..... 255
    - Overview ..... 255
    - Registering ..... 255
    - Saving stations ..... 255
    - Selecting and connecting to a station ..... 255
    - Selecting stream ..... 255
    - Setting options ..... 255
    - Terms of use ..... 255
  - iPhone®**
    - see Apple CarPlay™
  - ISOFIX child seat attachment**
    - Fitting ..... 34
    - Notes ..... 34
- J**
- Jack** ..... 320
    - Declaration of conformity ..... 22
    - Hydraulic ..... 300
    - Removing the hydraulic jack from the stowage compartment ..... 300
    - Storage location of hydraulic jack .... 300
  - Jump-start connection** ..... 286
  - Jump-starting**
    - see Jump-start connection
- K**
- Key** ..... 41
    - Acoustic locking verification signal .... 42
    - Battery ..... 42
    - Emergency key element ..... 42
    - Energy consumption ..... 42
    - Functions ..... 41
    - Key ring attachment ..... 42
    - Overview ..... 41
    - Problem ..... 43
    - Radio connection ..... 41
    - Unlocking setting ..... 42
- L**
- Ladder rack**
    - Maximum load ..... 343
    - Overview ..... 267
    - Platform truck ..... 267
    - technical data ..... 343
  - Lane detection (automatic)**
    - see Active Lane Keeping Assist
  - Lane Keeping Assist** ..... 166
    - Function ..... 166
    - System limitations ..... 166
    - Trailer operation ..... 166
  - Lane Keeping Assist**
    - see Active Lane Keeping Assist
    - see Lane Keeping Assist

- Language**
    - Notes ..... 207
    - Setting ..... 207
  - Lashing points**
    - Information ..... 342
  - Level control**
    - see ENR (electronic level control)
  - Licence plate lighting (changing bulbs)** ..... 90
  - Light switch (overview)** ..... 82
  - Lighting**
    - see Lights
  - Lights** ..... 82
    - Adaptive Highbeam Assist ..... 84
    - Automatic dipped beam ..... 82
    - Change bulbs ..... 87
    - Combination switch ..... 83
    - Cornering light ..... 84
    - Dipped beam ..... 82
    - Foreign trip ..... 82
    - Hazard warning lamps ..... 84
    - Headlamp flasher ..... 83
    - High beam ..... 83
    - Indicator ..... 83
    - Light switch ..... 82
    - Parking light ..... 82
    - Range ..... 83
    - Rear fog light ..... 82
    - Responsibility with lighting systems ... 82
    - Setting the instrument lighting ..... 177
    - Standing light ..... 82
  - Limiter** ..... 151
    - Buttons ..... 151
    - Calling up a speed ..... 151
    - Function ..... 151
    - Passive ..... 151
    - Permanent setting ..... 152
    - Requirements: ..... 151
    - Selecting ..... 151
    - Setting a speed ..... 151
    - Storing a speed ..... 151
    - Switching off ..... 151
    - Switching on ..... 151
    - System limitations ..... 151
  - Limiting speed** ..... 114
  - LINGUATRONIC** ..... 182
    - Application specific voice commands ..... 183
    - Audible help functions ..... 184
    - Entering numbers ..... 183
    - Global voice commands ..... 183
    - Improving speech quality ..... 184
    - Language setting ..... 183
    - Media player voice commands ..... 189
    - Message voice commands ..... 190
    - Multifunction steering wheel (operating) ..... 182
    - Navigation voice commands ..... 185
    - Notes on the voice commands ..... 184
    - Online voice control ..... 184
    - Operable functions ..... 183
    - Operating safety ..... 182
    - Radio voice commands ..... 188
    - Switch voice commands ..... 184
    - Telephone voice controls ..... 187
    - Text message voice commands ..... 190
    - Types of voice commands ..... 183
    - Vehicle voice commands ..... 191
    - Voice prompting ..... 182
  - Live Traffic Information**
    - Displaying subscription information ..... 226
    - Displaying the traffic map ..... 227
    - Displaying traffic incidents ..... 227
    - Information on subscription extension ..... 226
    - Registering on Mercedes PRO ..... 226
    - Showing local area messages ..... 227
    - Switching the traffic information display on ..... 227
  - Loading guidelines** ..... 73, 263
  - Locator lighting**
    - Switching on/off ..... 85
  - Lubricant additives**
    - see Additive
  - Lumbar support (4-way)** ..... 65
- M**
- Maintenance**
    - see ASSYST PLUS
  - Malfunction**
    - Restraint system ..... 27
  - Manual parking brake** ..... 141
    - Applying/releasing ..... 141
    - Emergency braking ..... 142
    - Folding up/down ..... 141
  - Manual transmission**
    - Engaging reverse gear ..... 122
    - Using the gearshift lever ..... 122
  - Manually inflating air bellows (ENR)** ... 132
  - Map** ..... 227, 229
    - Avoiding an area ..... 231
    - Avoiding an area (overview) ..... 231



- Changing an area ..... 231
- Deleting an area ..... 231
- Displaying Qibla ..... 232
- Displaying the compass ..... 232
- Displaying the map version ..... 231
- Displaying the next intersecting street ..... 230
- Displaying the satellite map ..... 233
- Displaying the traffic map ..... 227
- Displaying weather information ..... 233
- Map data ..... 232
- Moving ..... 229
- Selecting POI symbols ..... 230
- Selecting text information ..... 230
- Selecting the map orientation ..... 229
- Setting the map scale ..... 229
- Setting the map scale automatically ..... 232
- Switching motorway information on/off ..... 230
- Updating ..... 232
- Matt finish (cleaning instructions)** .... 278
- Maximum speed**  
see Limiter
- MBUX multimedia system (overview)** ..... 192
- Mecca** ..... 232
- Media**  
Menu (on-board computer) ..... 180  
Operating media playback ..... 180  
Selecting a media source ..... 180
- Media display**  
Entering characters ..... 203  
Home screen ..... 193  
Notes ..... 192
- Media mode**  
Adding a favourite song ..... 259  
Connecting Bluetooth® audio equipment ..... 258  
Connecting USB devices ..... 257  
Controlling media playback ..... 258  
Copyright and trademarks ..... 256  
Information about media search ..... 259  
Making video settings ..... 260  
Overview of the media menu ..... 257  
Playing back similar music tracks .... 259  
Removing a favourite song ..... 259  
Searching for a music track according to mood ..... 260  
Starting media playback ..... 258  
Starting the media search ..... 259  
Supported format and data storage media ..... 256
- Using the keyword search ..... 259
- Memory function (seat)** ..... 65
- Menu (on-board computer)**  
Assistance graphic ..... 178  
Media ..... 180  
Navigation ..... 179  
Overview ..... 175  
Radio ..... 180  
Service ..... 177  
Telephone ..... 181  
Trip ..... 178
- Mercedes PRO**  
Information ..... 248
- Mercedes PRO connect**  
Accident management ..... 247  
Calling the Customer Centre ..... 246  
Consenting to data transfer ..... 247  
Information ..... 246  
Making a call via the overhead control panel ..... 246  
Service call via the Service call button ..... 247  
Service message ..... 247  
Transferred data ..... 247
- Mercedes-Benz emergency call system** ..... 248  
Automatic emergency call ..... 248  
Information ..... 248  
Manual emergency call ..... 249  
Overview ..... 248  
Self-diagnosis (Russia) ..... 250  
Starting/ending ERA-GLONASS test mode ..... 250  
Transferred data ..... 249
- Mercedes-Benz service centre**  
see Qualified specialist workshop
- Message (multifunction display)**  
see Display message
- Message memory** ..... 345
- Messages** ..... 242  
Calling a message sender ..... 243  
Composing ..... 242  
Configuring the displayed text messages ..... 242  
Deleting ..... 243  
Forwarding ..... 243  
Overview ..... 242  
Read-aloud function ..... 242  
Reading ..... 242  
Replying ..... 243  
Sending ..... 242  
Using a number/URL ..... 243

Using templates .....	243
Voice commands (LINGUATRONIC) ..	190
<b>Mirrors</b>	
Adjusting the inside mirror .....	96
<b>Mirrors</b>	
see Outside mirrors	
<b>Mobile phone</b> .....	333
Cancelling permission for Internet connection .....	252
Frequencies .....	333
Transmission output (maximum) .....	333
Wireless charging .....	81
<b>Mobile phone</b>	
see Android Auto	
see Apple CarPlay™	
see Mobile phone	
see Telephone	
<b>Mobile phone voice recognition</b>	
Starting .....	238
Stopping .....	238
<b>Model series</b> .....	334
<b>Mounting a load</b> .....	73, 263
<b>Multifunction display (on-board computer)</b> .....	176
<b>Multifunction steering wheel</b>	
Button overview .....	175
<b>Multifunction steering wheel</b>	
see Steering wheel	
<b>Multimedia system</b>	
Adjusting the volume .....	196
Configuring display settings .....	204
Main functions .....	195
Restoring the factory settings .....	210
Switching the sound on/off .....	196
<b>Multimedia system</b>	
see MBUX multimedia system (overview)	

**N**

<b>Navigation</b>	
Menu (on-board computer) .....	179
Showing/hiding the menu .....	211
Switching on .....	211
Updating the map data .....	232
Voice commands (LINGUATRONIC) ..	185
<b>Navigation</b>	
see Destination	
see Destination entry	
see Route	
see Route guidance	
see Traffic information	

<b>Navigation announcements</b>	
Activating/deactivating .....	223
Adjusting the volume .....	224
Repeating .....	224
Switching audio fadeout on/off .....	224
Switching on/off during a phone call .....	223
<b>Navigation instructions (on-board computer)</b> .....	179
<b>Near Field Communication (NFC)</b> .....	237
Connecting the mobile phone to the multimedia system .....	237
General information .....	237
Switching mobile phones .....	237
Using a mobile phone .....	237

**NFC**

  see Near Field Communication (NFC)

<b>Notification types</b> .....	200
<b>Notifications Centre</b>	
Calling up notifications .....	200
Editing notifications .....	201
Global search .....	201
Notification types .....	200
Overview .....	200
Selecting actions for notifications .....	201
Using the global search .....	201

**Notifications Centre**

  see Notification types

**Nozzles**

  see Adjusting ventilation nozzles (roof)  
  see Air vents

**O**

<b>Occupant safety</b>	
Pets in the vehicle .....	40
<b>Occupant safety</b>	
see Airbag	
see Restraint system	
see Seat belt	
<b>Oil</b>	
see Engine oil	
<b>On-board computer</b> .....	175
Adjusting the stationary heater/ventilation .....	106
Assistance graphic menu .....	178
Displaying the service due date .....	270
Media menu .....	180
Menu navigation .....	179
Menus overview .....	175
Multifunction display .....	176
Operating .....	175
Radio menu .....	180

- Service menu ..... 177
  - Telephone menu ..... 181
  - Trip menu ..... 178
  - On-board diagnostics interface**
    - see Diagnostics connection
  - On-board electronics**
    - Engine electronics ..... 333
    - Notes ..... 333
    - Two-way radios ..... 333
  - Open-source software** ..... 26
  - Opening and closing the lockable compartment above the windscreen** .... 75
  - Opening/closing the bonnet** ..... 270
  - Operating fluids**
    - AdBlue® ..... 135, 338
    - Brake fluid ..... 339
    - Coolant (engine) ..... 340
    - Engine oil ..... 339
    - Fuel (diesel) ..... 336
    - Notes ..... 335
    - Windscreen washer fluid ..... 340, 341
  - Operating safety**
    - Changes in the engine power output ..... 23
    - Declaration of conformity (electromagnetic compatibility) ..... 22
    - Declaration of conformity (Jack) ..... 22
    - Declaration of conformity (wireless vehicle components) ..... 22
    - Information ..... 21
  - Operating sun visor** ..... 96
  - Operating system**
    - On-board computer ..... 175
  - Original parts** ..... 19
  - Outside mirrors** ..... 95
    - adjusting ..... 95
    - folding in/out ..... 95
    - Setting options ..... 14
  - Overhead control panel**
    - Adjusting the interior lighting ..... 85
    - Overview ..... 10
  - Overview of bulb types**
    - Tail lamp (chassis) ..... 91
    - Tail lamps (panel van and crewbus) .... 89
  - Owner's Manual (digital)** ..... 18
  - Owner's Manual (vehicle equipment)** ... 21
- P**
- Paint (cleaning instructions)** ..... 278
  - Paint code** ..... 334
  - Park pawl**
    - Deactivating manually ..... 126
  - Park position**
    - Engaging ..... 125
    - Engaging automatically ..... 125
  - Parking (navigation service)**
    - Notes ..... 233
    - Selecting parking options ..... 233
    - Showing a parking option on the map ..... 234
  - Parking aid**
    - see Parking Assist PARKTRONIC
  - Parking Assist PARKTRONIC** ..... 155
    - Activating ..... 156
    - Adjusting warning tones ..... 156
    - Deactivating ..... 156
    - Drive Away Assist ..... 165
    - Function ..... 155
    - System limitations ..... 155
  - Parking brake (electrical)**
    - see Electric parking brake
  - Parking brake (manual)**
    - see Manual parking brake
  - Parking light** ..... 82
  - Parking up** ..... 144
  - Partition sliding door**
    - from the driver's compartment ..... 51
    - from the load compartment ..... 52
  - Permissible axle load** ..... 334
  - Permissible gross mass** ..... 334
  - Permissible towing methods** ..... 293
  - Pets in the vehicle** ..... 40
  - Phone book**
    - see Contacts
  - PIN protection**
    - Switching on/off ..... 208
  - Placing a load on the wheel arch** ..... 269
  - Plastic trim (care)** ..... 281
  - Platform dropsides**
    - attaching/detaching ..... 54
    - Opening or closing ..... 53
    - Rear side ..... 53
    - Side walls ..... 54
  - POI symbols**
    - User defined ..... 230
  - Power supply**
    - Battery main switch ..... 122

- Switching on (start/stop button) ..... 110
- Power window**  
see Side windows
- Previous destinations**  
Selecting ..... 213
- Profile**  
Calling up suggestions ..... 198  
Configuring suggestions ..... 198  
Creating a new profile ..... 197  
Deleting suggestions ..... 198  
Maximum number of profiles ..... 197  
Overview ..... 197  
Renaming suggestions ..... 198  
Selecting a profile ..... 197  
Selecting profile options ..... 197  
Showing the profile selection when starting the vehicle ..... 197  
Suggestions (overview) ..... 197
- Profile**  
see User profile
- Q**
- Qibla** ..... 232
- QR code (rescue card)** ..... 24
- Qualified specialist workshop** ..... 23
- R**
- Rack systems (information)** ..... 266
- Radar sensors** ..... 145
- Radio**  
Activating/deactivating radio text .... 262  
Calling up the station list ..... 261  
Deleting channels ..... 261  
Direct frequency entry ..... 261  
Displaying information ..... 262  
Displaying radio text ..... 262  
Editing station presets ..... 261  
Frequency fix ..... 261  
Menu (on-board computer) ..... 180  
Moving stations ..... 261  
Overview ..... 260  
Searching for stations ..... 261  
Setting a channel ..... 261  
Setting station tracking ..... 261  
Setting the frequency band ..... 261  
Setting the traffic information service volume increase ..... 261  
Storing radio stations ..... 261  
Switching on ..... 260  
Switching traffic announcements on/off ..... 261  
Voice commands (LINGUATRONIC) .. 188
- Radio connection**  
Key ..... 41
- Real wood (care)** ..... 281
- Rear bench seat**  
see Seats
- Rear compartment heating** ..... 100
- Rear Cross Traffic Alert** ..... 165
- Rear doors**  
Opening and closing (from inside) ..... 51  
Opening and closing (from outside) .... 50
- Rear fog light** ..... 82
- Rear window wiper**  
replacing ..... 95  
switching on/off ..... 93
- Recycling**  
see Take-back of end-of-life vehicles (environmental protection)
- Reducing agent**  
see AdBlue®
- Refrigerant (air conditioning)**  
Notes ..... 341
- Refuelling**  
Refuelling the vehicle ..... 133  
Topping up AdBlue® ..... 136
- Regeneration**  
Cancelling ..... 121  
Starting ..... 121
- Registration**  
Vehicle ..... 24
- Regulating headlamp range** ..... 83
- Remote control (stationary heating)**  
Changing the battery ..... 106
- Remote control (stationary heating/ventilation)**  
Displays ..... 105  
Setting ..... 105
- Removing the vehicle tool kit** ..... 299
- Replacing a wheel**  
Fitting a new wheel ..... 325
- Rescue card** ..... 24
- Reset function (multimedia system)** .. 210
- Restoring (factory settings)**  
see Reset function (multimedia system)
- Restraint system** ..... 27  
Children, notes on safe transportation ..... 32  
Function in an accident ..... 28  
Functionality ..... 27

- Malfunction ..... 27
  - Protection ..... 27
  - Reduced protection ..... 27
  - Self-test ..... 27
  - Warning lamp ..... 27
  - Restricting the shift range** ..... 125
  - Reversing camera** ..... 157
    - Care ..... 279
    - Function ..... 157
    - Switching automatic operation on/off (360° Camera) ..... 161
  - Reversing light**
    - Changing bulbs ..... 91
    - Replacing light bulbs (panel vans and crewbuses) ..... 89
  - Rims (care)** ..... 279
  - Roll away protection**  
see HOLD function
  - Roof carrier (inside)** ..... 267
  - Roof lining (care)** ..... 281
  - Roof rack (information)** ..... 266
  - Route** ..... 216, 220
    - Accepting a detour recommendation after a prompt ..... 227
    - Activating a commuter route ..... 220
    - Calculating ..... 216
    - Displaying destination information ... 218
    - Displaying the route list ..... 219
    - Editing a stored route ..... 221
    - Planning ..... 219
    - Recording a route ..... 221
    - Saving a recorded route ..... 221
    - Selecting a type ..... 217
    - Selecting an alternative route ..... 220
    - Selecting notifications ..... 218
    - Selecting options ..... 218
    - Showing a stored route on the map ..... 221
    - Starting a saved route ..... 221
    - Starting the automatic service station search ..... 220
    - Switching the automatic filling station search on/off ..... 220
    - With intermediate destinations ..... 219
  - Route guidance** ..... 221
    - Cancelling ..... 224
    - Changing direction ..... 222
    - Destination reached ..... 223
    - From an off-road location ..... 225
    - Lane recommendations ..... 223
    - Motorway information ..... 223
    - Notes ..... 221
  - Off-road ..... 225
    - To an off-road destination ..... 224
  - Running-in notes** ..... 112
- S
- Safety vest** ..... 283
  - Seat belt** ..... 28, 30
    - Adjusting the height ..... 30
    - Care ..... 281
    - Protection ..... 28
    - Reduced protection ..... 29
    - Releasing ..... 30
    - Warning lamp ..... 30
    - Wearing ..... 30
  - Seat belt tensioners**
    - Activation ..... 28
  - Seat belt warning**  
see Seat belt
  - Seat cover (care)** ..... 281
  - Seats** ..... 60, 68
    - 4-way lumbar support ..... 65
    - 8-way adjustment options ..... 63
    - Adjusting armrests ..... 67
    - Adjusting the armrests (rear bench seat) ..... 71
    - Adjusting the head restraints mechanically ..... 71
    - Adjusting the seat cushion (double co-driver's seat) ..... 67
    - correct driver's seat position ..... 60
    - Folding the folding seat up / down .... 67
    - front (adjust electrically) ..... 63
    - Front (adjusting manually, with Seat Comfort Package) ..... 62
    - Front (adjusting manually) ..... 62
    - Front (adjusting mechanically, without Seat Comfort Package) ..... 60
    - Installing and removing rear bench seat ..... 68
    - Memory function ..... 63
    - Operating the memory function ..... 65
    - rotate (front seat) ..... 66
    - Setting options ..... 14
    - With Seat Comfort Package ..... 62
    - Without Seat Comfort Package ..... 60
  - Seats**  
see Double co-driver's seat
  - Securing luggage** ..... 73, 263
  - Selecting a POI**  
see Destination entry

- Selector lever**
  - see DIRECT SELECT lever
- Sensors (care)** ..... 279
- Service**
  - see ASSYST PLUS
- Service (on-board computer)** ..... 177
- Service centre**
  - see Qualified specialist workshop
- Service interval display**
  - see ASSYST PLUS
- Service products**
  - Refrigerant (air conditioning) ..... 341
- Setting a speed limit**
  - see Limiter
- Setting the date format** ..... 205
- Setting the distance unit** ..... 207
- Setting the map scale**
  - see Map
- Setting the speed**
  - see Cruise control
- Shifting gears**
  - Gearshift recommendation ..... 123
- Short messages**
  - see Messages
- Short-distance trips** ..... 114
- Side impact airbag** ..... 31
- Side marker lamps (replacing the light bulbs)** ..... 92
- Side window**
  - Closing using the key ..... 56
  - Convenience closing ..... 56
  - Convenience opening ..... 56
  - Opening with the key ..... 56
- Side windows** ..... 55
  - Adjusting ..... 56
  - Closing ..... 55
  - Closing (all) ..... 55
  - Opening ..... 55
  - Opening (all) ..... 55
  - Problem ..... 56
- Sliding door**
  - B-pillar door sill (button) ..... 47
  - Centre console (button) ..... 47
  - Child safety lock ..... 39
  - Closing (from inside) ..... 46
  - Closing (from outside) ..... 46
  - Opening (from inside) ..... 46
  - Opening (from outside) ..... 46
- Smartphone**
  - see Android Auto
  - see Apple CarPlay™
  - see Telephone
- Snow chains** ..... 302
- Socket (12 V)** ..... 78
  - Driver's seat ..... 78
  - Front centre console ..... 78
  - Load compartment ..... 79
- Socket (230 V) (centre console, front)** ..... 79
- Software update** ..... 208
  - Important system updates ..... 209
  - Information ..... 208
  - Performing ..... 209
- Sound**
  - see Tone settings
- Sound settings**
  - Adjusting the balance/fader ..... 262
  - Adjusting treble, mid-range and bass settings ..... 262
  - Automatic volume adjustment ..... 262
- Spare wheel**
  - Fitting/removing ..... 328
  - Notes ..... 327
- Specialist workshop** ..... 23
- Speech dialogue system**
  - see LINGUATRONIC
- Speed limitation for winter tyres**
  - Setting ..... 153
- Speedometer (digital)** ..... 178
- Standby mode**
  - Activating/deactivating ..... 145
- Standing light** ..... 82
- Start/stop button**
  - Parking the vehicle ..... 140
  - Starting the vehicle ..... 111
  - Switching on the power supply or the ignition ..... 110
- Starting**
  - see Vehicle
- Starting-off aid**
  - see Hill start assist
- Station**
  - Deleting ..... 261
  - Direct frequency entry ..... 261
  - Frequency fix ..... 261
  - Moving ..... 261
  - Searching ..... 261
  - Setting ..... 261

- Storing ..... 261
  - Station list**
    - Calling up ..... 261
  - Station presets**
    - Modifying ..... 261
  - Station tracking**
    - Setting ..... 261
  - Stationary heating/ventilation**
    - Adjusting (on-board computer) ..... 106
    - Displays (remote control) ..... 105
    - Setting (remote control) ..... 105
  - Stationary heating/ventilation**
    - see Hot-water auxiliary heater
  - Steering wheel** ..... 175
    - Adjusting ..... 72
    - Buttons ..... 175
  - Stop/start function**
    - see ECO start/stop function
  - Stopping the alarm (ATA)** ..... 58
  - Stowage areas**
    - see Stowage space
  - Stowage box** ..... 75
  - Stowage compartments**
    - see Stowage space
  - Stowage space** ..... 74
    - Armrest ..... 74
    - Centre console ..... 74
    - Cockpit ..... 74
    - Door ..... 74
    - Glasses compartment ..... 75
    - Glove compartment ..... 74
    - Stowage box ..... 75
  - Summer tyres** ..... 301
  - Surround View**
    - see 360° Camera
  - Switch clock**
    - Activating ..... 107
    - Setting ..... 107
    - Setting the departure time ..... 108
    - Setting the temperature/operating duration ..... 108
    - Switching immediate heating mode on/off ..... 108
  - Switch-off delay time**
    - Exterior ..... 85
    - Interior ..... 87
  - Switching on ignition (start/stop button)** ..... 110
  - Switching seat heating on/off** ..... 72
  - Switching the A/C function on or off** ..... 100
  - Switching the rear window heater on/off** ..... 102
  - Switching the windscreen heater on/off** ..... 102
  - System**
    - Setting the time/date format ..... 205
  - System settings**
    - Activating/deactivating PIN protection ..... 208
    - Language ..... 207
    - Notes on language selection ..... 207
    - Reset function (multimedia system) ..... 210
    - Setting the distance unit ..... 207
    - Setting the time and date automatically ..... 205
    - Setting the time zone ..... 205
  - System settings**
    - see Bluetooth®
    - see Data import/export
    - see Software update
    - see Wi-Fi
- T**
- Tailpipes (care)** ..... 279
  - Take-back of end-of-life vehicles (environmental protection)** ..... 19
  - Tank capacity**
    - Fuel ..... 337
    - Reserve (fuel) ..... 337
  - Tank content**
    - AdBlue® ..... 338
  - Technical data**
    - Information ..... 333
    - Notes (trailer hitch) ..... 341
    - Tyre pressure monitor ..... 316
    - Vehicle identification plate ..... 334
  - Telephone** ..... 181, 234
    - Activating functions during a call ..... 238
    - Calls with several participants ..... 238
    - Changing the function of a mobile phone ..... 236
    - Connecting a mobile phone (Near Field Communication (NFC)) ..... 237
    - Connecting a mobile phone (Pass-key) ..... 235
    - Connecting a mobile phone (Secure Simple Pairing) ..... 235

- Connecting a second mobile phone  
(Secure Simple Pairing) ..... 236
- Disconnecting a mobile phone ..... 237
- Importing contacts ..... 240
- Importing contacts (overview) ..... 240
- Incoming call during an existing  
call ..... 239
- Information ..... 235
- Interchanging mobile phones (two  
phone mode) ..... 236
- Menu (on-board computer) ..... 181
- Mobile phone voice recognition ..... 238
- Notes ..... 235
- Operating modes ..... 235
- Reception and transmission vol-  
ume ..... 237
- Ringtone volume ..... 238
- Switching mobile phones ..... 236
- Switching mobile phones (Near  
Field Communication (NFC)) ..... 237
- Telephone menu overview ..... 234
- Telephone operation ..... 238
- Two phone mode (function) ..... 236
- Using Near Field Communication  
(NFC) ..... 237
- Voice commands (LINGUATRONIC) .. 187
- Wireless charging (mobile phone) ..... 81
- Telephone operation**  
see Calls
- Telephony operating modes**  
Bluetooth® Telephony ..... 235
- Business telephony ..... 235
- TEMPMATIC (control panel)** ..... 98
- Text messages**  
Voice commands (LINGUATRONIC) .. 190
- Text messages**  
see Messages
- THERMOTRONIC (control panel)** ..... 99
- Time**  
Manual time setting ..... 205
- Setting the time and date automat-  
ically ..... 205
- Setting the time zone ..... 205
- Setting the time/date format ..... 205
- Timer**  
Overview ..... 107
- Tone settings** ..... 262  
Calling up the sound menu ..... 262
- Information ..... 262
- Tongue weight (maximum)** ..... 342
- Tool**  
see Removing the vehicle tool kit  
see Vehicle tool kit  
see Vehicle tool kit stowage compartment
- Top Tether** ..... 35
- Total distance recorder**  
see Display total distance (trip menu)
- Touch Control**  
On-board computer ..... 175
- Operating ..... 194
- Setting acoustic operating feed-  
back ..... 194
- Setting the sensitivity ..... 194
- Touchscreen (multimedia system  
display)**  
Operating ..... 194
- Tow starting** ..... 297
- Tow-away protection**  
Function ..... 58
- Switching on/off ..... 58
- Towing away** ..... 294  
Raised front or rear axle ..... 296
- Towing eye**  
Fitting/removing ..... 297
- Storage location ..... 297
- Towing eye (storage location)**  
see Vehicle tool kit
- Towing methods** ..... 293
- TPEG**  
Switching the traffic information  
display on ..... 227
- Traffic announcements**  
Activating/deactivating ..... 261
- Traffic information** ..... 225  
Displaying the traffic map ..... 227
- Displaying traffic incidents ..... 227
- Live Traffic Information ..... 226
- Overview ..... 225
- Switching the display on ..... 227
- Traffic information service volume  
increase**  
Setting ..... 261
- Traffic map**  
see Map
- Traffic Sign Assist** ..... 162  
Function/notes ..... 162
- Setting ..... 163
- System limitations ..... 162
- Trailer hitch**  
Attaching the ball coupling ..... 171



- Care ..... 279
- Detaching the ball coupling ..... 172
- General notes ..... 341
- Information about trailer operation .. 169
- Socket ..... 172
- Trailer loads** ..... 342
- Trailer operation**
- Active Lane Keeping Assist ..... 166
- Attaching the ball coupling ..... 171
- Coupling/Decoupling the trailer ..... 172
- Detaching the ball coupling ..... 172
- Lane Keeping Assist ..... 166
- Notes ..... 169
- Permissible axle load ..... 334
- Socket ..... 172
- Tongue weight (maximum) ..... 342
- Trailer loads ..... 342
- Trailer stabilisation** ..... 148
- Transferred vehicle data**
- Android Auto ..... 245
- Apple CarPlay™ ..... 245
- Transmission position display** ..... 123
- Transmission ratio**
- see Engaging/disengaging LOW RANGE
- Transport by rail** ..... 114
- Transporting (vehicle breakdown)** ..... 296
- Trim element (care)** ..... 281
- Trip (on-board computer)** ..... 178
- Trip computer**
- Resetting ..... 179
- Showing ..... 178
- Trip distance** ..... 178
- Resetting ..... 179
- Showing ..... 178
- Trip meter**
- see Trip distance
- Turn signal light**
- Additional turn signal light (all-wheel drive vehicles) ..... 89
- Two-way radio telephone**
- see Mobile phone
- Two-way radios**
- Frequencies ..... 333
- Installation notes ..... 333
- Transmission output (maximum) ..... 333
- Tyre pressure**
- Checking (tyre pressure monitoring system) ..... 315
- Notes ..... 303
- Restarting the tyre pressure monitor ..... 315
- Tyre pressure monitoring system (function) ..... 314
- Tyre pressure table ..... 303
- Tyre pressure monitor**
- Checking the tyre pressures ..... 315
- Checking the tyre temperature ..... 315
- Function ..... 314
- Restarting ..... 315
- Technical data ..... 316
- Tyre pressure table** ..... 303
- Tyre temperature**
- Checking (tyre pressure monitoring system) ..... 315
- Tyre pressure monitoring system (function) ..... 314
- Tyre tread** ..... 301
- Tyre-change tool kit** ..... 320
- Tyres**
- Checking ..... 301
- Checking the tyre pressure (tyre pressure monitoring system) ..... 315
- Direction of rotation ..... 320
- Fitting ..... 325
- Flat tyre ..... 284
- Noise ..... 301
- Notes on fitting ..... 318
- Removing ..... 324
- Replacing ..... 318, 321
- Restarting the tyre pressure monitor ..... 315
- Selecting ..... 318
- Snow chains ..... 302
- Storing ..... 320
- Summer tyres ..... 301
- Tyre pressure (Notes) ..... 303
- Tyre pressure monitoring system (function) ..... 314
- Tyre pressure table ..... 303
- Unusual driving characteristics ..... 301

## U

- Units of measurement**
- Setting ..... 207
- Unlocking setting** ..... 42
- Unlocking/locking**
- Additional door lock ..... 43
- Switching automatic locking feature on/off ..... 45
- Unlocking and opening front doors from inside ..... 44

<b>USB socket in the rear</b> .....	80
<b>User profile</b> .....	197
<b>Using kickdown</b> .....	126
<b>Using the chock</b> .....	145

## V

<b>Vehicle</b> .....	111
Additional door lock .....	43
Correct use .....	24
Data recording .....	24
Diagnostics connection .....	23
Equipment .....	21
Implied warranty .....	24
Locking (automatic) .....	45
Lowering .....	326
Parking (start/stop button) .....	140
parking up .....	144
QR code rescue card .....	24
Qualified specialist workshop .....	23
Raising .....	322
Registration .....	24
Starting (start/stop button) .....	111
Switching on power supply (start/ stop button) .....	110
Unlocking (from inside) .....	44
Ventilating (convenience opening) .....	56
Voice commands (LINGUATRONIC) ...	191
<b>Vehicle data</b> .....	
Showing .....	210
Transferring to Android Auto™ .....	245
Transferring to Apple CarPlay™ .....	245
Vehicle height .....	341
Vehicle length .....	341
Vehicle width .....	341
Wheelbase .....	341
<b>Vehicle data memory</b> .....	
Electronic control units .....	24
Service providers .....	25
<b>Vehicle dimensions</b> .....	341
<b>Vehicle identification number</b> see VIN	
<b>Vehicle identification plate</b> EU general operating permit num- ber .....	334
Paint code .....	334
Permissible axle load .....	334
Permissible gross mass .....	334
VIN .....	334
<b>Vehicle identification plate</b> see Model series	

## Vehicle key

see Key

## Vehicle level

Lowering .....	131
Raising .....	131

## Vehicle maintenance

see ASSYST PLUS

## Vehicle tool kit ..... 297, 299

## Vehicle tool kit stowage compart- ment ..... 299

## VIN

Identification plate .....	334
Reading out .....	334
Seat .....	334
Windscreen .....	334

## Voice command types (LINGUA- TRONIC) ..... 183

## Voice control system















see LINGUATRONIC







## W

## Warning triangle

Removing .....	283
Setting up .....	283

## Warning/indicator lamp ..... 5

 ABS warning lamp .....	372
 Brake system warning lamp (red) .....	374
 Brake system warning lamp (yellow) .....	373
 Coolant warning lamp .....	376
 Distance warning warning lamp .....	375
 Electrical fault warning lamp ....	376
 Engine diagnosis warning lamp .....	377
 ESP® OFF warning lamp .....	371
 ESP® warning lamp flashes .....	372
 ESP® warning lamp lights up ....	372
 Fuel reserve warning lamp .....	376
 Power steering system warn- ing lamp .....	375
 Red indicator lamp, electric parking brake applied .....	370, 371
 Red parking brake indicator lamp closed .....	371

-  Restraint system warning lamp ..... 369
-  Seat belt warning lamp flashes ..... 375
-  Seat belt warning lamp lights up ..... 375
-  Tyre pressure monitoring system warning lamp flashes ..... 377
-  Tyre pressure monitoring system warning lamp lights up ..... 378
-  Yellow electric parking brake indicator lamp is malfunctioning ..... 370, 371
- Warranty** ..... 24
- Washer fluid**  
see Windscreen washer fluid (notes)
- Washing by hand (care)** ..... 278
- Weather information** ..... 233
- Web browser**
  - Calling up a web page ..... 252
  - Calling up options ..... 253
  - Calling up the settings ..... 253
  - Deleting a bookmark ..... 254
  - Deleting Internet history ..... 254
  - Ending ..... 254
  - Managing bookmarks ..... 254
  - Overview ..... 253
- Website**
  - Calling up ..... 252
- Wheel rotation** ..... 320
- Wheel spanner** ..... 320
- Wheels**
  - Care ..... 279
  - Changing ..... 320
  - Checking ..... 301
  - Checking the tyre pressure (tyre pressure monitoring system) ..... 315
  - Fitting ..... 325
  - Flat tyre ..... 284
  - Noise ..... 301
  - Notes on fitting ..... 318
  - Removing ..... 324
  - Replacing ..... 318, 321
  - Restarting the tyre pressure monitor ..... 315
  - Selecting ..... 318
  - Snow chains ..... 302
  - Storing ..... 320
  - Tyre pressure (Notes) ..... 303
  - Tyre pressure monitoring system (function) ..... 314
  - Tyre pressure table ..... 303
  - Unusual driving characteristics ..... 301
- Wi-Fi** ..... 206
  - Adjusting ..... 206
  - Overview ..... 206
  - Setting up a hotspot ..... 207
  - Setting up an Internet connection .... 251
- Window airbag** ..... 31
- Windows**
  - Closing (all) ..... 55
  - Opening (all) ..... 55
- Windows**  
see Side windows
- Windows (care)** ..... 279
- Windscreen** ..... 93
  - Replacing the wiper blades ..... 93
  - Replacing the wiper blades (WET WIPER SYSTEM) ..... 94
- Windscreen**  
see Windscreen
- Windscreen washer fluid**
  - Information ..... 341
- Windscreen washer fluid (notes)** ..... 340
- Windscreen wipers**
  - Replacing the wiper blades ..... 93
  - Replacing the wiper blades (WET WIPER SYSTEM) ..... 94
  - switching on/off ..... 92
- Winter driving (snow chains)** ..... 302
- Winter tyres**
  - Setting the permanent speed limitation ..... 153
- Wiper blades**
  - Care ..... 279
  - Replacing (WET WIPER SYSTEM) ..... 94
  - Replacing (windscreen) ..... 93
- Wireless charging**
  - Function/notes ..... 80
  - Mobile phone ..... 81
- Wireless vehicle components (declaration of conformity)** ..... 22
- Workshop**  
see Qualified specialist workshop





## Publication details

### Internet

Further information about Mercedes-Benz vehicles and about Daimler AG can be found on the following websites:

<http://www.mercedes-benz.com>

<http://www.daimler.com>

### Documentation team

You are welcome to forward any queries or suggestions you may have regarding this Owner's Manual to the technical documentation team to the following address:

Daimler AG, HPC: CAC, Customer Service, 70546 Stuttgart, Germany

©Daimler AG: Not to be reprinted, translated or otherwise reproduced, in whole or in part, without written permission from Daimler AG.

### Vehicle manufacturer

Daimler AG

Mercedesstraße 137

70327 Stuttgart

Germany

## YOUR OWNER'S MANUALS



### Digital in the vehicle

Familiarise yourself with the contents of the Owner's Manual directly via the vehicle's multimedia system (Menu item "Vehicle"). Start with the quick guide or deepen your knowledge with practical tips.



### Vehicle document wallet in the vehicle

Here you can find information on operation, service work and the guarantee for your vehicle in printed form.



### Digital on the Internet

You can access the Owner's Manual on the Mercedes-Benz homepage.



### Digital as an app

The Mercedes-Benz Guides app is available free of charge in common app stores.



Apple® iOS



Android™



9075844702Z102